

2025 Illinois Statewide Technical Reference Manual for Energy Efficiency Version 13.0

Volume 1: Overview and User Guide

**FINAL
September 20, 2024**

**Effective:
January 1, 2025**

Table of Contents

VOLUME 1: OVERVIEW AND USER GUIDE

1 Purpose of the TRM.....	5
1.1 Acknowledgments	5
1.2 Summary of Measure Revisions	7
1.3 Enabling ICC Policy	22
1.4 Development Process.....	22
1.4.1 Reliability Review	24
2 Organizational Structure.....	26
2.1 Measure Code Specification	26
2.2 Components of TRM Measure Characterizations	27
2.3 Variable Input Tables.....	28
2.3.1 C&I Custom Value Use in Measure Implementation	29
2.4 Program Delivery & Baseline Definitions	29
2.4.1 Default Measure Type for Program Delivery Methods.....	31
3 Assumptions	33
3.1 Footnotes & Documentation of Sources	33
3.2 General Savings Assumptions	33
3.3 Shifting Baseline Assumptions	33
3.3.1 Linear Fixture Baseline Assumptions	34
3.3.2 Early Replacement Baseline Assumptions	34
3.3.3 Furnace Baseline	34
3.4 Carryover Savings / Deferred Installs	35
3.5 Provisional Measures Savings Assumptions.....	35
3.6 Glossary	36
3.7 Electrical Loadshapes (kWh).....	41
3.8 Summer Peak Period Definition (kW).....	47
3.9 Heating and Cooling Degree-Day Data	47
3.10 Measure Incremental Cost Definition	52
3.11 Discount Rates, Inflation Rates, and O&M Costs	53
3.12 Interactive Effects.....	55
3.13 Electrification and Fossil Fuel Baselines (Public Act 102-0662).....	55
3.13.1 Fossil Fuel Baseline Efficiencies for Electric Efficiency Measures	55
3.13.2 Fuel Units and Conversion Factors	57
3.14 Secondary kWh Savings from Fossil Fuel Saving Measures.....	58

VOLUME 2: COMMERCIAL AND INDUSTRIAL MEASURES

VOLUME 3: RESIDENTIAL MEASURES

VOLUME 4: CROSS-CUTTING MEASURES AND ATTACHMENTS

ATTACHMENT A: ILLINOIS STATEWIDE NET-TO-GROSS METHODOLOGIES

ATTACHMENT B: EFFECTIVE USEFUL LIFE FOR CUSTOM MEASURE GUIDELINES

ATTACHMENT C: FRAMEWORK FOR COUNTING MARKET TRANSFORMATION SAVINGS IN ILLINOIS

Tables and Figures

Table 1.1: Document Revision History.....6

Table 1.2: Summary of Measure Level Changes7

Table 1.3: Summary of Measure Revisions.....9

Table 1.4: Summary of Attachment A: IL-NTG Methods Revisions21

Table 2.1: End-Use Categories in the TRM26

Table 2.2: Measure Code Specification Key.....27

Table 3.2: On- and Off-Peak Energy Definitions41

Table 3.3: Loadshapes by Season43

Table 3.5: Degree-Day Zones and Values by Market Sector.....48

Figure 3.1: Cooling Degree-Day Zones by County49

Figure 3.2: Heating Degree-Day Zones by County50

Table 3.6: Heating Degree-Day Zones by County50

Table 3.7: Cooling Degree-day Zones by County51

1 Purpose of the TRM

The purpose of the Illinois Statewide Technical Reference Manual (TRM or IL-TRM) is to provide a transparent and consistent basis for calculating energy (electric kilowatt-hours (kWh) and natural gas therms) and capacity (electric kilowatts (kW)) savings generated by the State of Illinois’ energy efficiency programs,¹ which are administered by the state’s largest electric and gas Utilities (collectively, Program Administrators or the Utilities).²

The TRM is a technical document that is filed with the Illinois Commerce Commission (Commission or ICC) and is intended to fulfill a series of objectives, including:

- “Serve as a common reference document for all... stakeholders, [Program Administrators], and the Commission, so as to provide transparency to all parties regarding savings assumptions and calculations and the underlying sources of those assumptions and calculations.
- Support the calculation of the Illinois Total Resource Cost test (“TRC”),³ as well as other cost-benefit tests in support of program design, evaluation, and regulatory compliance. Actual cost-benefit calculations and the calculation of avoided costs will not be part of this TRM.
- Identify gaps in robust, primary data for Illinois, that can be addressed via evaluation efforts and/or other targeted end-use studies.
- [Provide] a process for periodically updating and maintaining records, and preserve a clear record of what deemed parameters are/were in effect at what times to facilitate evaluation and data accuracy reviews.
- ...[S]upport coincident peak capacity (for electric) savings estimates and calculations for electric utilities in a manner consistent with the methodologies employed by the utility’s Regional Transmission Organization (“RTO”), as well as those necessary for statewide Illinois tracking of coincident peak capacity impacts.”⁴

1.1 Acknowledgments

This document was created through collaboration among the members of the Illinois Energy Efficiency Stakeholder Advisory Group (SAG). The SAG is an open forum where interested parties may participate in the evolution of Illinois’ energy efficiency programs. Parties wishing to participate in the SAG process may do so by visiting <http://www.ilsag.info/questions.html> and contacting the Independent Facilitator, Celia Johnson, at celia@celiajohnsonconsulting.com. Parties wishing to participate in the Technical Advisory Committee (TAC), a subcommittee of the SAG, may do so by contacting the TRM Administrator at iltrmadministrator@veic.org.

SAG/TAC Stakeholders ⁵
Ad Hoc Group
ADM Associates
Ameren Illinois Company (Ameren)
Apex Analytics
Applied Energy Group
Cadmus
Brightline Group
Brubaker and Associates, Inc (BAI)
Citizen's Utility Board (CUB)
CAMI Energy
Cascade Energy

¹ 220 ILCS 5/8-103B and 220 ILCS 5/8-104.

² The Program Administrators include: Ameren Illinois, ComEd, Peoples Gas, North Shore Gas, and Nicor Gas (collectively, the Utilities).

³ The Illinois TRC test is defined in 220 ILCS 5/8-104(b) and 20 ILCS 3855/1-10.

⁴ Illinois Statewide Technical Reference Manual Request for Proposals, August 22, 2011, pages 3-4, http://ilsag.org/yahoo_site_admin/assets/docs/TRM_RFP_Final_part_1.230214520.pdf

⁵ Being an open forum, this list of SAG stakeholders and participants may change at any time.

SAG/TAC Stakeholders ⁵
City of Chicago
CLEAResult
Commonwealth Edison Company (ComEd)
Community and Economic Development Association Cook County
CNT Energy
DNV GL
Driftless Energy
Ecometric
Elevate Energy
Energy Futures Group
Energy Resources Center at the University of Illinois, Chicago (ERC)
Environment IL
Environmental Law and Policy Center (ELPC)
First Tracks Consulting Service, Inc.
Franklin Energy
Frontier Energy
Future Energy Enterprises LLC
GDS Associates
GTI Energy
Guidehouse
ICF
Illinois Association of Community Action Agencies
Illinois Attorney General's Office (AG)
Illinois Commerce Commission Staff (ICC Staff)
Illume Advising
International Energy Conservation Consultants (IECC)
Leidos
Metropolitan Mayor's Caucus (MMC)
Michaels Energy
Midwest Energy Efficiency Association (MEEA)
Morehead Energy
National Energy Foundation
Natural Resources Defense Council (NRDC)
Nicor Gas
Opinion Dynamics
Optimal Energy
Peoples Gas and North Shore Gas
Resource Innovations
SCS Analytics
Slipstream
Southern Gas Company
Sustain Rockford
Walker Miller Energy
WEC Energy
360 Energy Group

Table 1.1: Document Revision History

Document Title	Applicable to PY Beginning
Illinois_Statewide_TRM_Effective_060112_Version_1.0_091412_Clean.doc	6/1/12
Illinois_Statewide_TRM_Effective_060113_Version_2.0_060713_Clean.docx	6/1/13
Illinois_Statewide_TRM_Effective_060114_Version_3.0_022414_Clean.docx	6/1/14
Illinois_Statewide_TRM_Effective_060115_Final_022415_Clean.docx	6/1/15
IL-TRM_Effective_060116_v5.0_Vol_1_Overview_021116_Final IL-TRM_Effective_060116_v5.0_Vol_2_C_and_I_021116_Final IL-TRM_Effective_060116_v5.0_Vol_3_Res_021116_Final IL-TRM_Effective_060116_v5.0_Vol_4_X-Cutting_Measures_and_Attach_021116_Final	6/1/16
IL-TRM_Effective_010118_v6.0_Vol_1_Overview_020817_Final IL-TRM_Effective_010118_v6.0_Vol_2_C_and_I_020817_Final IL-TRM_Effective_010118_v6.0_Vol_3_Res_020817_Final IL-TRM_Effective_010118_v6.0_Vol_4_X-Cutting_Measures_and_Attach_020817_Final	1/1/18
IL-TRM_Effective_010119_v7.0_Vol_1_Overview_092818_Final IL-TRM_Effective_010119_v7.0_Vol_2_C_and_I_092818_Final IL-TRM_Effective_010119_v7.0_Vol_3_Res_092818_Final IL-TRM_Effective_010119_v7.0_Vol_4_X-Cutting_Measures_and_Attach_092818_Final	1/1/19
IL-TRM_Effective_010120_v8.0_Vol_1_Overview_101719_Final IL-TRM_Effective_010120_v8.0_Vol_2_C_and_I_101719_Final IL-TRM_Effective_010120_v8.0_Vol_3_Res_101719_Final IL-TRM_Effective_010120_v8.0_Vol_4_X-Cutting_Measures_and_Attach_101719_Final	1/1/20
IL-TRM_Effective_010121_v9.0_Vol_1_Overview_092420_Final IL-TRM_Effective_010121_v9.0_Vol_2_C_and_I_092420_Final IL-TRM_Effective_010121_v9.0_Vol_3_Res_092420_Final IL-TRM_Effective_010121_v9.0_Vol_4_X-Cutting_Measures_and_Attach_092420_Final	1/1/21
IL-TRM_Effective_010122_v10.0_Vol_1_Overview_09242021_Final IL-TRM_Effective_010122_v10.0_Vol_2_C_and_I_09242021_Final IL-TRM_Effective_010122_v10.0_Vol_3_Res_09242021_Final IL-TRM_Effective_010122_v10.0_Vol_4_X-Cutting_Measures_and_Attach_09242021_Final	1/1/22
IL-TRM_Effective_010123_v11.0_Vol_1_Overview_09232022_Final IL-TRM_Effective_010123_v11.0_Vol_2_C_and_I_09232022_Final IL-TRM_Effective_010123_v11.0_Vol_3_Res_09232022_Final IL-TRM_Effective_010123_v11.0_Vol_4_X-Cutting_Measures_and_Attach_09232022_Final	1/1/23
IL-TRM_Effective_010124_v12.0_Vol_1_Overview_09222023_Final IL-TRM_Effective_010124_v12.0_Vol_2_C_and_I_09222023_Final IL-TRM_Effective_010124_v12.0_Vol_3_Res_09222023_Final IL-TRM_Effective_010124_v12.0_Vol_4_X-Cutting_Measures_and_Attach_09222023_Final	1/1/24
IL-TRM_Effective_010125_v13.0_Vol_1_Overview_09202024_Final IL-TRM_Effective_010125_v13.0_Vol_2_C_and_I_09202024_Final IL-TRM_Effective_010125_v13.0_Vol_3_Res_09202024_Final IL-TRM_Effective_010125_v13.0_Vol_4_X-Cutting_Measures_and_Attach_09202024_Final	1/1/25

1.2 Summary of Measure Revisions

The following tables summarize the evolution of measures that are new, revised or errata. This version of the TRM contains 155 measure-level changes as described in the following table.

Table 1.2: Summary of Measure Level Changes

Change Type	# Changes
Errata	26
Revision	119

Change Type	# Changes
New Measure	8
Retired	2
Total Changes	155

The 'Change Type' column indicates what kind of change each measure has gone through. Specifically, when a measure error was identified and the TAC process resulted in a consensus, the measure is identified here as an 'Errata'. In these instances, the measure code indicates that a new version of the measure has been published, and that the effective date of the measure dates back to January 1, 2024. Measures that are identified as 'Revised' were included in the twelfth edition of the TRM and have been updated for this edition of the TRM. Both 'Revised' and 'New Measure(s)' have an effective date of January 1, 2025.

The following table provides an overview of the 155 measure-level changes included in this version of the TRM.

Table 1.3: Summary of Measure Revisions

Volume	End Use	Measure Name	Measure Code	Change Type	Explanation	Impact on Savings
Volume 1: Overview	N/A	2 Organizational Structure	N/A	Revision	Addition of “Shell” end use category. All shell measures have been moved to section 4.8, and Miscellaneous is now 4.9.	N/A
		2.0 Measure Code Specification		Revision	Removal of “Equipment” from 2 end-use categories. Corresponding changes made in Volume 2.	N/A
		3.9 Heating and Cooling Degree-Day Data		Revision	List of TMYx weather station files used has been provided.	N/A
		3.11 Discount Rates, Inflation Rates, and O&M Costs		Revision	Addition of values for 2026-2029	N/A
Volume 2 – Commercial and Industrial Measures	Agricultural	4.1.11 Commercial LED Grow Lights	CI-AGE-GROW-V06-240101	Errata	Fixed error in calculation file of CFs where additional hour out of peak period was being included.	Increase
			CI-AGE-GROW-V07-250101	Revision	Updated to leverage new DLC Horticultural specifications, v3.0. Addition of New Construction (NC) as an applicable program type with IECC 2021 baseline.	N/A
		4.1.13 Irrigation Pump VFD	CI-AGE-PUMP-V02-250101	Revision	Example added.	N/A
		4.1.14 High Efficiency Grain Dryer	CI-AGE-GDRY-V02-250101	Revision	Example added.	N/A
		4.1.16 Greenhouse Boiler Tune-Up	CI-AGE-GTUNE-V02-250101	Revision	Typo fixes.	N/A
		4.1.17 Greenhouse Thermal Curtains	CI-AGE-GHEAT-V03-250101	Revision	Updates to measure cost	N/A
		4.1.19 ENERGY STAR Dairy Water Heater	CI-AGE-ESWH-V04-250101	Revision	Updates to code language and effective Residential water heater ENERGY STAR spec.	N/A
		4.1.20 Commercial Electric Lawn Mower	CI-AGE-CELM-V02-250101	Revision	Example added.	N/A
	Food Service	4.2.1 Combination Oven	CI-FSE-CBOV-V06-250101	Revision	Update to coincidence factor. Fix to example calculation.	Increase
		4.2.3 Steam Cooker	CI-FSE-STMC-V08-240101	Errata	Idle calculation fixed to divide preheat time by 60 minutes per hour.	Decrease
			CI-FSE-STMC-V09-250101	Revision	Addition of unknown option to coincident factor table.	N/A

Volume	End Use	Measure Name	Measure Code	Change Type	Explanation	Impact on Savings
		4.2.5 ENERGY STAR Convection Oven	CI-FSE-ESCV-V06-250101	Revision	Update to coincidence factor.	Increase
		4.2.6 ENERGY STAR Dishwasher	CI-FSE-ESDW-V08-250101	Revision	Update measure life assumptions.	Decrease
		4.2.7 ENERGY STAR Fryer	CI-FSE-ESFR-V06-250101	Revision	Update to coincidence factor.	Increase
		4.2.8 ENERGY STAR Griddle	CI-FSE-ESGR-V07-250101	Revision	Update to coincidence factor.	Increase
		4.2.9 ENERGY STAR Hot Food Holding Cabinet	CI-FSE-ESHH-V05-250101	Revision	Update to coincidence factor.	Increase
		4.2.12 Infrared Charbroiler	CI-FSE-IRCB-V04-250101	Revision	Example added.	N/A
		4.2.16 Kitchen Demand Ventilation Controls	CI-FSE-VENT-V07-250101	Revision	Reduction in heating interactive effect savings by reducing the 'Annual Heating Load' assumptions.	Decrease
		4.2.18 Rack Oven - Double Oven	CI-FSE-RKOV-V04-240101	Errata	Fixed error in deemed savings calculation. Added Days variable to Algorithm section.	Decrease
		4.2.22 Automatic Conveyor Broiler	CI-FSE-ACBL-V02-240101	Errata	Fixed error in preheat energy calculation.	Decrease
	CI-FSE-ACBL-V03-250101		Revision	Example added.	N/A	
	Hot Water	4.3.1 Water Heater	CI-HWE-STWH-V11-240101	Errata	Updates to code language. Fixed error in large water heater fuel switch calculation and added fuel switch example	Dependent on inputs
		4.3.4 Commercial Pool Covers	CI-HWE-PLCV-V06-250101	Revision	Updates to code language.	N/A
		4.3.7 Multifamily Central Domestic Hot Water Plants	CI-HWE-MDHW-V08-250101	Revision	Updates to code language. Update to MF Household assumption.	N/A
		4.3.8 Controls for Central Domestic Hot Water	CI-HWE-CDHW-V07-250101	Revision	Clarification to boiler capacity assumption	N/A
		4.3.10 DHW Boiler and Water Heater Tune-up	CI-HWE-DBTU-V03-250101	Revision	Addition of all water heater types in addition to DHW boiler. Addition of methodology to calculate consumption by number of people for multifamily. Update to incoming water temperature T_{in} assumption.	Dependent on inputs
		4.3.11 Tunnel Washers	CI-HWE-TUWA-V03-250101	Revision	Update to incoming water temperature T_{in} assumption.	Increase
	HVAC	4.4.6 Electric Chiller	CI-HVC-CHIL-V10-250101	Revision	Update to measure costs. Example added.	N/A

Volume	End Use	Measure Name	Measure Code	Change Type	Explanation	Impact on Savings
		4.4.7 ENERGY STAR and CEE Tier 2 Room AC	CI-HVC-ESRA-V04-240101	Errata	Update to ENERGY STAR and CEE Tier 2 specifications that came into effect in October 2023. Measure cost update.	Increase
		4.4.9 Air and Water Source Heat Pump Systems (Centrally Ducted and Ductless)	CI-HVC-HPSY-V12-250101	Revision	Combining ducted and ductless (4.4.59) measures. Updates to code language. Addition of deemed early replacement and full v partial displacement assumptions. Addition of accounting for distribution savings. Addition of ability to analyze partial displacement scenarios	Dependent on inputs
		4.4.10 High Efficiency Boiler	CI-HVC-BOIL-V12-240101	Errata	Update to baseline after the 2023 Federal Standard update was vacated.	Increase
		4.4.11 High Efficiency Furnace	CI-HVC-FRNC-V14-250101	Revision	Update to residential sized unit's measure cost.	N/A
		4.4.12 Infrared Heaters	CI-HVC-IRHT-V04-250101	Revision	Minor clarifications added.	N/A
		4.4.13 Package Terminal Air Conditioner (PTAC) and Package Terminal Heat Pump (PTHP)	CI-HVC-PTAC-V13-250101	Revision	Correction to RUL label to match measure life section.	N/A
		4.4.14 Pipe Insulation	CI-HVC-PINS-V09-250101	Revision	Example calculation added.	N/A
		4.4.15 Single-Package and Split System Unitary Air Conditioners	CI-HVC-SPUA-V11-250101	Revision	Updates to code language. Fix example calculations.	N/A
		4.4.16 Steam Trap Replacement or Repair	CI-HVC-STRE-V11-250101	Revision	Minor clarifications added.	N/A
		4.4.17 Variable Speed Drives for HVAC Pumps and Cooling Tower Fans	CI-HVC-VSDHP-V11-250101	Revision	Updates to code language. Added more incremental cost options for differing motor sizes. Added a motor efficiency table in place of a single static default motor efficiency.	Dependent on inputs
		4.4.20 High Turndown Burner for Space Heating Boilers	CI-HVC-HTBC-V07-250101	Revision	Updated heating run hours and hours when boiler is cycling with new TMYx data. Updated reference sources.	Dependent on inputs
		4.4.26 Variable Speed Drives for HVAC Supply and Return Fans	CI-HVC-VSDF-V10-250101	Revision	Updates to code language.	N/A
		4.4.27 Energy Recovery Ventilator	CI-HVC-ERVE-V07-250101	Revision	Updates to code language.	N/A
		4.4.28 Stack Economizer for Boilers Serving HVAC Loads	CI-HVC-BECO-V03-250101	Revision	Minor clarifications added.	N/A

Volume	End Use	Measure Name	Measure Code	Change Type	Explanation	Impact on Savings
		4.4.29 Stack Economizer for Boilers Serving Process Loads	CI-HVC-PECO-V03-250101	Revision	Clarification added to measure life to be consistent with change made in 4.4.28.	N/A
		4.4.33 Commercial & Industrial Air Curtain	CI-HVC-AIRC-V07-250101	Revision	Edited to include Commercial as well as Industrial air curtains. Additional size options added. Deemed HVAC efficiencies provided.	Dependent on inputs
		4.4.34 Destratification Fan	CI-HVC-DSFN-V08-250101	Revision	Updated efficiency table with code updates	N/A
		4.4.38 Covers and Gap Sealers for Room Air Conditioners	CI-HVC-CRAC-V04-250101	Revision	Addition of tables if floor of AC is unknown.	Dependent on inputs
		4.4.40 Gas High Efficiency Single Package Vertical Air Conditioner	CI-HVC -SPVA-V03-250101	Revision	Update to EFLH assumptions to match multifamily assumptions in Residential volume. Example calculations updated.	Increase
		4.4.44 Commercial Ground Source and Ground Water Source Heat Pump	CI-HVC-GSHP-V09-250101	Revision	Updates to code language. Fix to new construction example calculation.	N/A
		4.4.48 Small Commercial Thermostats	CI-HVC-THST-V07-250101	Revision	Example added.	N/A
		4.4.51 Advanced Rooftop Controls with High Rotor Pole Switch Reluctance Motors	CI-HVC-HSRM-V05-240101	Errata	Addition of load factor and motor efficiency into the energy savings algorithm since study used is calculated on brake horsepower and not nominal horsepower.	Dependent on inputs
			CI-HVC-HSRM-V06-250101	Revision	Updates to code language.	N/A
		4.4.54 Process Heating Boiler	CI-HVC-PHBO-V04-240101	Errata	Update to baseline after the 2023 Federal Standard update was vacated.	Increase
		4.4.55 Commercial Gas Heat Pump	CI-HVC-GFHP-V04-250101	Revision	Updates to code language. Update to Tin assumption.	Increase
		4.4.56 Commercial Duct Sealing	CI-HVC-DSEAL-V02-250101	Revision	Fixing labelling issue of Avg_Htg_OAT and Avg_Duct_Htg_SAT.	N/A
		4.4.57 Condensate Recovery System	CI-HVC-CNDR-V02-250101	Revision	Fix error in default measure cost.	N/A
		4.4.59 Ductless Heat Pumps	N/A	Removed	Measure removed and combined with 4.4.9 Air and Water Source Heat Pump System (Centrally Ducted and Ductless)	N/A
		4.4.62 Cooling Tower Water Side Economizer	CI-HVC-CTWE-V02-250101	Revision	Minor clarifications added.	N/A
		4.4.65 Computer Room Air Conditioner (CRAC)	CI-HVC-CRAC-V01-250101	New	New measure.	N/A

Volume	End Use	Measure Name	Measure Code	Change Type	Explanation	Impact on Savings
		4.4.66 Steam Leak Repair	CI-HVC-SLKR-V01-250101	New	New measure.	N/A
	Lighting	4.5.4 LED Bulbs and Fixtures	CI-LTG-LEDB-V18-250101	Revision	Addition of mogul LED ISR assumption. Clarification of measure life for lamps impacted by EISA to limit at 8 years.	Dependent on inputs
		4.5.7 Lighting Power Density	CI-LTG-LPDE-V10-250101	Revision	Updates to code language.	N/A
		4.5.10 Lighting Controls	CI-LTG-OSLC-V09-250101	Revision	Example added. Added Energy Savings Factor assumptions for Exterior Networked Lighting Controls; with LLLC, without LLLC and unknown.	N/A
		4.5.13 Occupancy Controlled Bi-Level Lighting Fixtures	CI-LTG-OCBL-V06-240101	Errata	Clarification that measure is limited to 24/7 operation and therefore CFbaseline fixed to 1.0.	Increase
	Refrigeration	4.6.4 Electronically Commutated Motors (ECM) for Walk-in and Reach-in Coolers/Freezers	CI-RFG-ECMF-V05-250101	Revision	Measure cost update.	N/A
		4.6.5 ENERGY STAR Refrigerated Beverage Vending Machine	CI-RFG-ESVE-V05-250101	Revision	Minor clarifications added.	N/A
		4.6.8 Refrigeration Economizers	CI-RFG-ECON-V08-240101	Errata	Fixed analysis error where condenser fan savings had not been appropriately adjusted to reflect Illinois climate.	Decrease
		4.6.12 Variable Speed Drive for Condenser Fans	CI-RFG-VSC-V03-250101	Revision	Minor clarifications added.	N/A
		4.6.15 Zero Energy Doors for Refrigerated Cases	CI-RFG-ZED-V01-250101	New	New measure.	N/A
		4.6.16 Door Gaskets for Walk-in and Reach-in Coolers and Freezers	CI-RFG-DGS-V01-250101	New	New measure.	N/A
	Compressed Air	4.7.3 Compressed Air No-Loss Condensate Drains	CI-CPA-NCLD-V04-250101	Revision	Measure life and Coincident Factor update.	Decrease
		4.7.4 Efficient Compressed Air Nozzles	CI-CPA-CNOZ-V04-250101	Revision	Example added.	N/A
		4.7.12 AODD Pump Controls	CI-CPA-AODD-V02-250101	Revision	Provided default assumptions for the system power reduction per air demand if compressor control type unknown.	N/A
		4.7.13 Compressed Air Leak Repair	CI-CPA-CALR-V02-250101	Revision	Example added.	N/A

Volume	End Use	Measure Name	Measure Code	Change Type	Explanation	Impact on Savings
	Shell	4.8.1 (previously 4.8.2) Roof Insulation for C&I Facilities	CI-SHL-RINS-V09-250101	Revision	Updates to code language. Addition of loadshapes C04 Commercial Electric Heating and C05 Commercial Electric Heating and Cooling.	N/A
		4.8.4 (previously 4.8.27) C&I Air Sealing	CI-SHL-CAIR-V04-250101	Revision	Change of heating/cooling load methodology to use EFLH * ΔT (as opposed to using HDD/CDDs) to better reflect different commercial building types and to align with Roof Insulation measure.	Dependent on inputs
		4.8.7 (previously 4.8.30) Commercial Wall Insulation	CI-SHL-WINS-V04-250101	Revision	Measure cost updates. Change of heating/cooling load methodology to use EFLH * ΔT (as opposed to using HDD/CDDs) to better reflect different commercial building types and to align with Roof Insulation measure.	Dependent on inputs
		4.8.8 Commercial Secondary Windows	CI-SHL-CSW-V01-250101	New	New measure.	N/A
	Miscellaneous	4.9.4 (previously 4.8.5) High Speed Clothes Washer	CI-MSC-HSCW-V04-250101	Revision	Additional options for high speed clothes washer upgrades.	N/A
		4.9.8 (previously 4.8.9) High Frequency Battery Chargers	CI-MSC-BACH-V03-240101	Errata	Fixed error in kW algorithm.	N/A
			CI-MSC-BACH-V04-250101	Revision	Update to measure cost. Adjustment to savings factors resulting in reduction in savings. Addition of EREP as applicable market.	Decrease
		4.9.11 (previously 4.8.13) Variable Speed Drives for Process Fans	CI-MSC-VSDP-V04-250101	Revision	Updates to code language.	N/A
		4.9.13 (previously 4.8.15) Smart Irrigation Controls	CI-MSC-SIRC-V03-250101	Revision	Example added.	N/A
		4.9.15 (previously 4.8.18) ENERGY STAR Low Wattage Uninterruptible Power Supply	CI-MSC-UPSE-V04-250101	Revision	Restriction of measure to low wattage applications (less than or equal to 1,875 watts). Savings updated utilizing the latest ENERGY STAR qualified product list.	Dependent on inputs
		4.9.16 (previously 4.8.19) Energy Efficient Rectifier and High Wattage UPS	CI-MSC-RECT-V04-250101	Revision	Addition of high wattage UPS applications (greater than 1,875 watts).	N/A
		4.9.22 (previously 4.8.25) Warm-Mix Asphalt Chemical Additives	CI-MSC-WMIX-V02-240101	Errata	Fixed error in SF table for Additives.	Dependent on inputs

Volume	End Use	Measure Name	Measure Code	Change Type	Explanation	Impact on Savings
		4.9.24 Elevator Modernization	CI-MS-ESVMD-V01-250101	New	New measure.	N/A
Volume 3 - Residential Measures	Appliances	5.1.1 ENERGY STAR Air Purifier/Cleaner	RS-APL-ESAP-V07-250101	Revision	Addition of ENERGY STAR Most Efficient. Update to Federal Standard.	Decrease
		5.1.2 ENERGY STAR Clothes Washer	RS-APL-ESCL-V12-240101	Errata	Fixed transcription error in electric v fuel DHW split for Peoples Gas unknown, and resultant all DU value.	N/A
			RS-APL-ESCL-V13-250101	Revision	Update to IQAdj. Update to number of cycles assumption. Updates to %Electric_DHW and %Fossil_DHW assumption.	Decrease
		5.1.3 ENERGY STAR Dehumidifier	RS-APL-ESDH-V11-250101	Revision	Addition of Whole Home Dehumidifiers. Measure cost update.	N/A
		5.1.4 ENERGY STAR Dishwasher	RS-APL-ESDI-V10-240101	Errata	Fixed transcription error in electric v fuel DHW split for Peoples Gas unknown, and resultant all DU value.	N/A
			RS-APL-ESDI-V11-250101	Revision	Updates to %Electric_DHW and %Fossil_DHW assumption. Update to measure cost.	N/A
		5.1.6 ENERGY STAR, CEE Tier 2 or CEE Tier 3 Refrigerator	RS-APL-ESRE-V11-250101	Revision	Measure cost update.	N/A
		5.1.7 ENERGY STAR and CEE Tier 2 Room Air Conditioner	RS-APL-ESRA-V10-240101	Errata	Update to ENERGY STAR and CEE Tier 2 specifications that came into effect in October 2023.	Increase
			RS-APL-ESRA-V11-250101	Revision	Combining IQ and non-IQ version of measure.	N/A
		5.1.10 ENERGY STAR Clothes Dryer	RS-APL-ESDR-V07-250101	Revision	Update to number of cycles assumption.	Decrease
		5.1.12 Ozone Laundry	RS-APL-OZNE-V06-240101	Errata	Fixed transcription error in electric v fuel DHW split for Peoples Gas unknown, and resultant all DU value.	N/A
			RS-APL-OZNE-V07-250101	Revision	Updates to %Electric_DHW and %Fossil_DHW assumption. Update to number of cycles assumption. Hours assumption aligned and MF assumption added.	N/A
		5.1.13 Income Qualified: ENERGY STAR and CEE Tier 2 Room Air Conditioner	RS-APL-ESRA-V11-240101	Errata	Update to ENERGY STAR and CEE Tier 2 specifications that came in to effect in October 2023.	Increase

Volume	End Use	Measure Name	Measure Code	Change Type	Explanation	Impact on Savings
			N/A	Removed	Measure removed and combined with 5.1.7 ENERGY STAR and CEE Tier 2 Room Air Conditioner	N/A
		5.1.14 Residential Induction Cooking Appliances	RS-MSC-INDC-V03-250101	Revision	Updates to %ElectricHeat and %FossilHeat assumption.	N/A
		5.1.15 Residential Bolt-On Smart Dryer Sensor	RS-APL-SCDS-V02-250101	Revision	Update to number of cycles assumption.	Decrease
		5.1.17 ENERGY STAR All-in-One Clothes Washer-Dryer	RS-APL-ACWD-V01-250101	New	New measure.	N/A
	Consumer Electronics	5.2.1 Advanced Power Strip – Tier 1	RS-CEL-SSTR-V10-250101	Revision	Clarification on direct install installations.	N/A
	Consumer Electronics	5.2.3 ENERGY STAR Televisions	RS-CEL-TVS-V02-250101	Revision	Minor clarifications added.	N/A
	HVAC	5.3.1 Centrally Ducted Air Source Heat Pump (Central, Ductless and Portable)	RS-HVC-ASHP-V15-250101	Revision	Addition of Portable Heat Pumps. Addition of full load hour assumption for ductless minisplit HPs providing supplemental cooling. Clarification that unknown efficiency ratings should not be derated by age.	N/A
		5.3.2 Boiler Pipe Insulation	RS-HVC-PINS-V08-250101	Revision	Measure life and measure cost update.	Decrease
		5.3.3 Central Air Conditioning	RS-HVC-CAC1-V13-250101	Revision	Addition of assumptions for mobile homes. Clarification that unknown efficiency ratings should not be derated by age. Existing unit efficiency assumption updated to 9.2 SEER2 and 7.4EER2 to align with the ASHP measure and the referenced document.	Dependent on inputs
		5.3.4 Duct Insulation and Sealing	RS-HVC-DINS-V13-250101	Revision	Addition of methodology for duct insulation savings. Clarification of multifamily application. Updates to %ElectricHeat and %FossilHeat assumption.	N/A
		5.3.6 Gas High Efficiency Boiler	RS-HVC-GHEB-V12-250101	Revision	Clarification that unknown efficiency ratings should not be derated by age. Measure cost update.	N/A
		5.3.7 Gas High Efficiency Furnace	RS-HVC-GHEF-V14-250101	Revision	Clarification that unknown efficiency ratings should not be derated by age. Measure cost update.	N/A

Volume	End Use	Measure Name	Measure Code	Change Type	Explanation	Impact on Savings
		5.3.8 Ground Source Heat Pump	RS-HVC-GSHP-V15-250101	Revision	Clarification that unknown efficiency ratings should not be derated by age. Measure cost update. Update to Household assumption (number of people) based on draft Baseline Study Data.	Increase
		5.3.9 High Efficiency Bathroom Exhaust or Radon Mitigation Fan	RS-HVC-BAFA-V04-250101	Revision	Addition of Radon mitigation fan.	N/A
		5.3.10 HVAC Tune Up (Central Air Conditioning or Air Source Heat Pump)	RS-HVC-TUNE-V09-250101	Revision	Clarification of multifamily application.	N/A
		5.3.11 Programmable Thermostats	RS-HVC-PROG-V09-250101	Revision	Clarification of multifamily application.	N/A
		5.3.13 Residential Furnace Tune-Up	RS-HVC-FTUN-V08-240101	Errata	Typo fix in algorithm – 100,000 Btu per therm.	N/A
		5.3.16 Advanced Thermostats	RS-HVC-ADTH-V10-250101	Revision	Clarification of multifamily application. ISR for self install added.	N/A
		5.3.17 Gas High Efficiency Combination Boiler	RS-HVC-COMB-V05-250101	Revision	Update to Household assumption (number of people) based on draft Baseline Study Data.	Increase
		5.3.20 Residential Energy Recovery Ventilator (ERV)	RS-HVC-ERVS-V03-240101	Errata	Remove erroneous 24 factor from cooling algorithm.	Decrease
	RS-HVC-ERVS-V04-250101		Revision	Update to loadshape. Update to HDD and CDD based on updated climate data. Updates to %ElectricHeat and %GasHeat assumption.	Dependent on inputs	
	Hot Water	5.4.1 Domestic Hot Water Pipe Insulation	RS-HWE-PINS-V08-240101	Errata	Fixed transcription error in electric v fuel DHW split for Peoples Gas unknown, and resultant all DU value.	N/A
			RS-HWE-PINS-V09-250101	Revision	Update to measure life. Updates to %Electric_DHW and %Fossil_DHW assumption.	N/A
		5.4.2 Gas Water Heater	RS-HWE-GWHT-V12-250101	Revision	Update to measure life and measure cost. Update to Household assumption (number of people) based on draft Baseline Study Data.	Increase

Volume	End Use	Measure Name	Measure Code	Change Type	Explanation	Impact on Savings
		5.4.3 Heat Pump Water Heaters	RS-HWE-HPWH-V14-250101	Revision	Adjustment to the % heat removed from surrounding air that results in increased heating load. Updates to %ElectricHeat and %FossilHeat assumption. Update to Household assumption (number of people) based on draft Baseline Study Data.	Dependent on inputs
		5.4.4 Low Flow Faucet Aerators	RS-HWE-LFFA-V14-240101	Errata	Fixed transcription error in electric v fuel DHW split for Peoples Gas unknown, and resultant all DU value.	N/A
			RS-HWE-LFFA-V15-250101	Revision	Update to Direct Install ISR. Updates to %Electric_DHW and %FossilDHW assumption. Update to Household assumption (number of people) based on draft Baseline Study Data.	N/A
		5.4.5 Low Flow Showerheads	RS-HWE-LFSH-V13-240101	Errata	Fixed transcription error in electric v fuel DHW split for Peoples Gas unknown, and resultant all DU value.	N/A
			RS-HWE-LFSH-V14-250101	Revision	Update to Direct Install ISR. Updates to %Electric_DHW and %FossilDHW assumption. Update to Household assumption (number of people) based on draft Baseline Study Data.	Increase
		5.4.8 Thermostatic Restrictor Shower Valve	RS-HWE-TRVA-V08-240101	Errata	Fixed transcription error in electric v fuel DHW split for Peoples Gas unknown, and resultant all DU value.	N/A
			RS-HWE-TRVA-V09-250101	Revision	Update to measure cost. Updates to %Electric_DHW and %FossilDHW assumption. Update to Household assumption (number of people) based on draft Baseline Study Data.	Increase
		5.4.9 Shower Timer	RS-DHW-SHTM-V06-240101	Errata	Fixed transcription error in electric v fuel DHW split for Peoples Gas unknown, and resultant all DU value.	N/A
			RS-DHW-SHTM-V07-250101	Revision	Updates to %Electric_DHW and %FossilDHW assumption. Update to Household assumption (number of people) based on draft Baseline Study Data.	Increase

Volume	End Use	Measure Name	Measure Code	Change Type	Explanation	Impact on Savings
		5.4.11 Drain Water Heat Recovery	RS-DHW-DWHR-V05-250101	Revision	Update to Household assumption (number of people) based on draft Baseline Study Data.	Increase
		5.4.12 Recirculating Pump Controls	RS-HWE-CDHW-V02-250101	Revision	Updated measure cost. Assumptions updated to reflect residential applications. Update to Household assumption (number of people) based on draft Baseline Study Data.	Increase
		5.4.13 Auto-Diverting Tub Spout System	RS-HWE-ADTS-V01-250101	New	New measure	N/A
	Lighting	5.5.11 LED Nightlights	RS-LTG-NITL-V03-250101	Revision	Replacement of 3 year ISR to single lifetime ISR assumption.	N/A
		5.5.12 Connected LED Lamps	RS-LTG-LEDC-V04-250101	Revision	Removal of erroneous default wattage and replacement with standard lumen range/wattage table.	Increase
	Shell	5.6.1 Air Sealing	RS-SHL-AIRS-V14-250101	Revision	Clarification of multifamily application. Updates to %ElectricHeat and %FossilHeat assumption. Clarification that unknown efficiency ratings should not be derated by age.	N/A
		5.6.2 Basement Sidewall Insulation	RS-SHL-BINS-V15-250101	Revision		
		5.6.3 Floor Insulation Above Crawlspace	RS-SHL-FINS-V16-250101	Revision		
		5.6.4 Wall Insulation	RS-SHL-WINS-V14-250101	Revision		
		5.6.5 Ceiling/Attic Insulation	RS-SHL-AINS-V08-250101	Revision		
		5.6.6 Rim/Band Joist Insulation	RS-SHL-RINS-V07-250101	Revision		
		5.6.7 Low-E Storm Window	RS-SHL-LESW-V04-250101	Revision	Clarification of multifamily application.	N/A
		5.6.8 High Performance Windows	RS-SHL-TTWI-V04-240101	Errata	Fixed transcription error in savings tables for single pane windows.	N/A
	RS-SHL-TTWI-V05-250101		Revision	Removal of Retrofit as applicable program type. Clarification of baseline for Time of Sale applications. Update of code level windows to include IECC 2021 levels.	N/A	
5.6.9 Insulated Cellular Shades	RS-SHL-INCS-V03-250101	Revision	Clarification of multifamily application. Clarification that unknown efficiency ratings should not be derated by age.	N/A		

Volume	End Use	Measure Name	Measure Code	Change Type	Explanation	Impact on Savings
		5.6.11 Insulated Concrete Forms	RS-SHL-ICF-V02-250101	Revision	Clarification of multifamily application. Updates to %ElectricHeat and %FossilHeat assumption. Clarification that unknown efficiency ratings should not be derated by age.	N/A
	Miscellaneous	5.7.1 High Efficiency Pool Pumps	RS-MS-C-RPLP-V04-250101	Revision	Assumptions updated based on updated QPL.	Dependent on inputs
		5.7.2 Low Flow Toilets	RS-MS-C-LFTU-V02-250101	Revision	Update to Household assumption (number of people) based on draft Baseline Study Data.	Increase
		5.7.5 Tree Planting	RS-HVC-TREE-V03-250101	Revision	Clarification of multifamily application. Updates to %ElectricHeat and %FossilHeat assumption.	N/A
Volume 4 – Cross-Cutting Measures and Attachments	Behavior	6.1.1 Adjustments to Behavior Savings to Account for Persistence	CC-BEH-BEHP-V06-250101	Revision	Addition of Retention Rates for when first year savings are negative.	N/A

Table 1.4: Summary of Attachment A: IL-NTG Methods Revisions

IL-TRM Volume	Sectors	Protocol Name	Change Type	Explanation
Vol. 4	Commercial, Industrial, and Public Sector	Core Non-Residential Free Ridership	Revision	Clarification to counterfactual FR score follow-up likelihood question
Vol. 4	Commercial, Industrial, and Public Sector	Core Non-Residential Free Ridership	Revision	Clarification to timing consistency check
Vol. 4	Commercial, Industrial, and Public Sector	C&I New Construction	Revision	Addition of prior participation adjustment and guidance on counterfactual granularity

1.3 Enabling ICC Policy

This Illinois Statewide Technical Reference Manual (TRM) was developed to comply with the Illinois Commerce Commission (ICC or Commission) Final Orders from the electric and gas Utilities’ Energy Efficiency Plan dockets.⁶ In the Final Orders, the ICC required the utilities to work with the Illinois Department of Commerce and Economic Opportunity (DCEO) and the Illinois Energy Efficiency Stakeholder Advisory Group (SAG) to develop a statewide TRM. See, e.g., ComEd’s Final Order (*Docket No. 10-0570, Final Order⁷ at 59-60, December 21, 2010*); Ameren’s Final Order (*Docket No. 10-0568, Order on Rehearing⁸ at 19, May 24, 2011*); Peoples Gas/North Shore Gas’ Final Order (*Docket No. 10-0564, Final Order⁹ at 76, May 24, 2011*), and Nicor’s Final Order (*Docket No. 10-0562, Final Order¹⁰ at 30, May 24, 2011*).

As directed in the Utilities’ Efficiency Plan Orders, the SAG had the opportunity to, and also participated in, every aspect of the development of the TRM. Interested members of the SAG participated in weekly teleconferences to review, comment, and participate in the development of the TRM. The active participants in the TRM were designated as the “Technical Advisory Committee” (TAC). The TAC participants include representatives from the following organizations:

- the Utilities (ComEd, Ameren IL, Nicor Gas, Peoples Gas/North Shore Gas),
- Implementation contractors,
- Illinois Department of Commerce and Economic Opportunity (DCEO),
- the independent evaluators,
- ICC Staff,
- the Illinois Attorney General’s Office (AG),
- Natural Resources Defense Council (NRDC),
- the Environmental Law and Policy Center (ELPC),
- the Citizen’s Utility Board (CUB),
- The University of Illinois at Chicago,
- Future Energy Enterprises,
- Issue-specific invited participants, including; Geothermal Alliance of Illinois, the Geothermal Exchange Organization, Embertec, Trane, TrickleStar, Oracle, Google Nest, Ecobee, and US EPA ENERGY STAR.

1.4 Development Process

Each version of the IL-TRM is approved by the Commission in the ICC Dockets listed below, and can all be found on the ICC webpage; <https://www.icc.illinois.gov/programs/illinois-statewide-technical-reference-manual-for-energy-efficiency>. Errata to the IL-TRM versions may also be found on that ICC IL-TRM webpage.

TRM Version	ICC Docket Number
Version 1.0	12-0528
Version 2.0	13-0437
Version 3.0	14-0189

⁶ The Illinois Utilities subject to this TRM include: Ameren Illinois Company d/b/a Ameren Illinois (Ameren), Commonwealth Edison Company (ComEd), The Peoples Gas Light and Coke Company and North Shore Gas Company, and Northern Illinois Gas Company d/b/a Nicor Gas.

⁷ <http://www.icc.illinois.gov/docket/files.aspx?no=10-0570&docId=159809>

⁸ <http://www.icc.illinois.gov/docket/files.aspx?no=10-0568&docId=167031>

⁹ <http://www.icc.illinois.gov/docket/files.aspx?no=10-0564&docId=167023>

¹⁰ <http://www.icc.illinois.gov/docket/files.aspx?no=10-0562&docId=167027>

TRM Version	ICC Docket Number
Version 4.0	15-0187
Version 5.0	16-0171
2018 Version 6.0	17-0106
2019 Version 7.0	18-1605
2020 Version 8.0	19-0954
2021 Version 9.0	20-0741
2022 Version 10.0	21-0751
2023 Version 11.0	22-0603
2024 Version 12.0	23-0709
2025 Version 13.0	

The policies surrounding the applicability and use of the IL-TRM in planning, implementation, and evaluation were originally established by the Commission in ICC Docket No. 13-0077,¹¹ and most recently in ICC Docket Nos. 17-0270¹² and 19-0983.¹³

This document represents the eleventh version of the IL-TRM and applies to Section 8-103B and Section 8-104 energy efficiency programs. It contains a series of new measures, as well as a series of errata items¹⁴ and updates to existing measures already present in the first nine versions. Like the previous versions, it is a result of an ongoing review process involving the Illinois Commerce Commission (ICC) Staff (Staff or ICC Staff), the Utilities, the Evaluators, the SAG TAC, and the SAG. VEIC meets with the SAG and/or the TRM TAC at least once each month to create a high level of transparency and vetting in the development of this TRM.

Measure requests that are submitted by interested parties are ranked based on the following criteria to determine the approximate priority level for order of inclusion in the TRM:

1. High Priority
 - a. For those existing measures that make up a significant portion of a utilities’ portfolio and/or where the impact of the requested change is high
 - b. For new measures where plans are in place to implement in the next program year
2. Medium Priority
 - a. For existing measures that are a less significant percent of a utilities’ portfolio and value change will not have a significant impact
 - b. For new measures where a savings value is estimated but implementation plans not yet developed
3. Low Priority
 - a. For existing measures that represent a very small percent of a utilities’ portfolio
 - b. For new measures that are just beginning to be explored and will not be implemented in the next program year

These rankings are used to align budget and schedule constraints with desired updates from the TRM.

As measure requests are finalized leading up to the next update of the TRM, weekly TAC meetings are often scheduled to maximize collaboration and visibility into the measure characterization process. Where consensus does

¹¹<http://www.icc.illinois.gov/docket/files.aspx?no=13-0077&docid=203903>;
<http://www.icc.illinois.gov/docket/files.aspx?no=13-0077&docid=195913>;
<http://www.icc.illinois.gov/downloads/public/edocket/339744.pdf>

¹² <https://www.icc.illinois.gov/docket/files.aspx?no=17-0270&docid=257523>

¹³ <https://icc.illinois.gov/docket/P2019-0983/documents/292186> Please see IL-TRM Policy Document Version 3.0 available at <https://icc.illinois.gov/docket/P2019-0983/documents/292186/files/509718.pdf>

¹⁴ Errata as well as links to the official IL-TRM documents, dockets, and policy documents are available on the following ICC webpage: <http://www.icc.illinois.gov/Electricity/programs/TRM.aspx>

not emerge on specific measures or issues, those items are identified in a memo. As a result, this TRM represents a broad consensus amongst the SAG and TAC participants. In keeping with the goal of transparency, all of the comments and their status to date are available through the TAC SharePoint web site, <https://portal.veic.org>.

For each measure characterization, this TRM includes engineering algorithm(s) and a value(s) for each parameter in the equation(s). These parameters have values that fall into one of three categories: a single deemed value, a lookup table of deemed values or an actual value such as the capacity of the equipment. The TRM makes extensive use of lookup tables because they allow for an appropriate level of measure streamlining and customization within the context of an otherwise prescriptive measure.

Accuracy is the overarching principle that governs what value to use for each parameter. When it is explicitly allowed within the text of the measure characterization, the preferred value is the actual or on-site value for the individual measure being implemented. The *deemed values*¹⁵ in the lookup tables are the next most accurate choice, and in the absence of either an actual value or an appropriate value in a lookup table, the single, *deemed value* should be used. As a result, this single, *deemed value* can be thought of as a default value for that particular input to the algorithm.

A single *deemed savings estimate* is produced by any given combination of an algorithm and the allowable input values for each of its parameters. In cases where lookup tables are provided, there is a range of deemed savings estimates that are possible, depending on site-specific factors such as equipment capacity, location and building type.

Algorithms and their parameter values are included for calculating estimated:

- Gross annual electric energy savings (kWh)
- Gross annual natural gas energy savings (therms)
- Gross electric summer coincident peak demand savings (kW)

To support cost-effectiveness and cumulative persisting annual savings (CPAS) calculations, parameter values are also included for:

- Incremental costs (\$)
- Measure life (years)
- Operation and maintenance costs (\$)
- Water (gal) and other resource savings where appropriate.

1.4.1 Reliability Review

The process of incorporating new and better information into the TRM occurs annually as new measures and errors are identified, program designs change, old measures are dropped from programs, or other external events (such as code and standard changes or new evaluations and other data) warrant a review of assumptions. However, not all measures have updates triggered by such events, and some measures continue to appear in the TRM without ongoing review. Short of proactively identified issues that would trigger an update to a TRM characterization, a regular reliability review should be undertaken to assess that the information in older measures is still relevant and reliable. This review will include a general appraisal of reasonableness and continued program relevancy and an update of any assumptions to reflect new information.

To ensure that measures initially developed in the past and not recently revisited are updated and retired as needed, each measure is given a Review Deadline – a date that triggers a reliability review. This Review Deadline is established for each measure based on factors such as expected revisions to energy codes or federal standards; knowledge of upcoming evaluation or research efforts; knowledge of rapidly changing technology, cost, baselines, or other factors; or expected shifts in current customer practices. No Review Deadline is longer than six years from the date of the

¹⁵ Emphasis has been added to denote the difference between a “deemed value” and a “deemed savings estimate”. A deemed value refers to a single input value to an algorithm, while a deemed savings estimate is the result of calculating the end result of all of the values in the savings algorithm.

initial characterization or last update of a measure. The TRM Administrator will propose Review Deadlines for each measure, and they are reviewed and approved by the TAC. The Review Deadline for each measure is indicated in the measure characterization within the TRM. For example, a Review Deadline specified as 1/1/2026 means that the measure will be reviewed no later than the annual IL-TRM update process that occurs in 2025, in advance of the 1/1/2026 Review Deadline. Following a review and/or update, a new Review Deadline will be assigned to that measure.

2 Organizational Structure

The organization of this document follows a three-level format. These levels are designed to define and clarify what the measure is and where it is applied.

1. Market Sectors Volumes¹⁶

- This level of organization specifies the type of customer the measures apply to, either Commercial and Industrial (provided in Volume 2), Residential (provided in Volume 3), or cross-cutting measures, such as Behavior Persistence (provided in Volume 4, together with Attachments including the documentation of Illinois Statewide Net-to-Gross Methodologies, Guidelines for EULs for Custom Measures, and Framework for Counting Market Transformation Savings in Illinois).
- Answers the question, “What category best describes the customer?”

2. End-use Category

- This level of organization represents most of the major end-use categories for which an efficient alternative exists. The following table lists all of the end-use categories in this version of the TRM.
- Answers the question, “To what end-use category does the measure apply?”

Table 2.1: End-Use Categories in the TRM¹⁷

Volume 2: Commercial and Industrial Market Sector	Volume 3: Residential Market Sector	Volume 4: Cross-Cutting Measures and Attachments
Agricultural Equipment	Appliances	Behavior
Food Service Equipment	Consumer Electronics	System Wide
Hot Water	Hot Water	
HVAC	HVAC	
Lighting	Lighting	
Refrigeration	Shell	
Compressed Air	Miscellaneous	
Shell		
Miscellaneous		

3. Measure & Technology

- This level of organization represents individual efficient measures such as CFL lighting and LED lighting, both of which are individual technologies within the Lighting end-use category.
- Answers the question, “What technology defines the measure?”

This organizational structure is silent on which fuel the measure is designed to save; electricity or fossil fuels. By organizing the TRM this way, measures that save on both fuels do not need to be repeated. As a result, the TRM will be easier to use and to maintain.

2.1 Measure Code Specification

In order to uniquely identify each measure in the TRM, abbreviations for the major organizational elements of the TRM have been established. When these abbreviations are combined and delimited by a dash ('-') a unique, 18-character alphanumeric code is formed that can be used for tracking the measures and their associated savings estimates. Measure codes appear at the end of each measure and are structured using five parts.

¹⁶ Note that the Public sector buildings and low income measures are not listed as a separate Market Sector. The Public building type is one of a series of building types that are included in the appropriate measures in the Commercial and Industrial Sector.

¹⁷ Please note that this is not an exhaustive list of end-uses and that others may be included in future versions of the TRM.

Code Structure = Market + End-use Category + Measure + Measure Version # + Effective Date

For example, the commercial boiler measure is coded: “CI-HVC-BLR_-V01-120601”

Table 2.2: Measure Code Specification Key

Market (@@)	End-use (@@@)	Measure (@@@@)	Version (V##)	Effective Date
CI (C&I)	AGE (Agricultural)	BLR_	V01	YYMMDD
RS (Residential)	APL (Appliances)	T5FX	V02	YYMMDD
CC (Cross-Cutting)	BEH (Behavior)	T8FX	V03	YYMMDD
	CEL (Consumer Electronics)
	CPA (Compressed Air)			
	FSE (Food Service)			
	HVC (HVAC)			
	HWE (Hot Water)			
	LTG (Lighting)			
	MSC (Miscellaneous)			
	RFG (Refrigeration)			
	SHL (Shell)			
	SYS (System-wide)			

2.2 Components of TRM Measure Characterizations

Each measure characterization uses a standardized format that includes at least the following components. Measures with a higher level of complexity may have additional components, but also follow the same format, flow and function.

DESCRIPTION

Brief description of measure stating how it saves energy, the markets it serves and any limitations to its applicability.

DEFINITION OF EFFICIENT EQUIPMENT

Clear definition of the criteria for the efficient equipment used to determine delta savings. Including any standards or ratings if appropriate.

DEFINITION OF BASELINE EQUIPMENT

Clear definition of the efficiency level of the baseline equipment used to determine delta savings including any standards or ratings if appropriate. If a Time of Sale measure the baseline will be new base level equipment (to replace existing equipment at the end of its useful life or for a new building). For Early Replacement or Early Retirement measures the baseline is the existing working piece of equipment that is being removed.

DEEMED LIFETIME OF EFFICIENT EQUIPMENT

The expected duration in years (or hours) that the measure is expected to provide savings. Please see “Measure Life” in Section 3.5 Glossary. This is often based on the rated technical life of the equipment but may also be adjusted in consideration of the potential for users to remove or remodel and to allow for breakages or imperfect operation. If the savings of a population is expected to *decline* due to outcomes such as the overriding of settings or poorly maintaining equipment, a midlife adjustment should be used to reduce the lifetime savings ¹⁸; however, the measure lifetime should still reflect the technical lifetime (i.e. total years any savings are expected to occur).

¹⁸ In rare cases, for example residential Home Energy Report (HER) type programs, it may be appropriate to have savings decay each year throughout the measure life rather than in a midlife adjustment.

If an early replacement measure, the assumed Remaining Useful Life (RUL) of the existing unit is also provided.

DEEMED MEASURE COST

For time of sale measures, incremental cost from baseline to efficient is provided. Installation costs should only be included if there is a difference between each efficiency level. For Early Replacement the full equipment and install cost of the efficient installation is provided in addition to the full deferred hypothetical baseline replacement cost. See '3.9 Measure Incremental Cost Definition' for more detailed information concerning incremental cost calculations.

LOADSHAPE

The appropriate loadshape to apply to electric savings is provided.

COINCIDENCE FACTOR

The summer coincidence factor is provided to estimate the impact of the measure on the utility's system peak – defined as 1PM to hour ending 5PM on non-holiday weekdays, June through August.

Algorithm

CALCULATION OF ENERGY SAVINGS

Algorithms are provided followed by list of assumptions with their definition.

If there are no Input Variables, there will be a finite number of Output values. These will be identified and listed in a table. Where there are custom inputs, an example calculation is often provided to illustrate the algorithm and provide context.

ELECTRIC ENERGY SAVINGS

SUMMER COINCIDENT PEAK DEMAND SAVINGS

FOSSIL FUEL SAVINGS

WATER IMPACT DESCRIPTIONS AND CALCULATION

DEEMED O&M COST ADJUSTMENT CALCULATION

Only required if the operation and maintenance cost for the efficient case is different to the baseline. See '3.9 Measure Incremental Cost Definition' for information on the appropriate treatment of O&M costs.

MEASURE CODE

REVIEW DEADLINE

If not otherwise updated as part of an identified new TRM issue request before this Review Deadline, the measure will undergo a reliability review for reasonableness, continued program relevancy, and update of material assumptions during the update cycle prior to this deadline.

2.3 Variable Input Tables

Many of the measures in this TRM require the user to select the appropriate input value from a list of inputs for a given parameter in the savings algorithm. Where the TRM asks the user to select the input, look-up tables of allowable values are provided. For example, a set of input parameters may depend on building type; while a range of values may be given for each parameter, only one value is appropriate for any specific building type. If no table of alternative inputs is provided for a particular parameter, then the single deemed value will be used, unless the

measure has a custom allowable input.

2.3.1 C&I Custom Value Use in Measure Implementation

This section defines the requirements for capturing Custom variables that can be used in place of defaults for select assumptions within the prescriptive measures defined in this statewide TRM. This approach is to be used when a variable in a measure formula can be replaced by a verifiable and documented value that is not presented in the TRM. This approach assumes that the algorithms presented in the measure are used as stated and only allows changes to certain variable values and is not a replacement algorithm for the measure. A custom variable is when customer input is provided to define the number, or the value is measured at the site. Custom values can also be supplied from product data of the measure installed. In certain cases, the custom data can be provided from a documented study or report that is applicable to the measure. Custom variables and potential sources are clearly defined in the specific measures where “Actual”, or “Custom” is noted.

In exceptional cases where the participant, program administrator, and independent evaluator all agree that the TRM algorithm for a particular energy efficiency measure does not accurately characterize the energy efficiency measure within a project due to the complexity in the design and configuration of the particular energy efficiency project, a more comprehensive custom engineering and financial analysis may be used that more accurately incorporates the attributes of the measure in the complex energy efficiency project. In such cases and consistent with Commission policy adopted in ICC Docket No. 17-0270, Program Administrators are subject to retrospective evaluation risk (retroactive adjustments to savings based on ex post evaluation findings) for such projects using customized savings calculations.

2.4 Program Delivery & Baseline Definitions

The measure characterizations in this TRM are not grouped by program delivery type. As a result, the measure characterizations provided include information and assumptions to support savings calculations for the range of program delivery options commonly used for the measure. The organizational significance of this approach is that multiple baselines, incremental costs, O&M costs, measure lives and in-service rates are included in the measure characterization(s) that are delivered under two or more different program designs. Values appropriate for each given program delivery type are clearly specified in the algorithms or in look-up tables within the characterization.

Care has been taken to clearly define in the measure’s description the types of program delivery that the measure characterization is designed to support. However, there are no universally accepted definitions for a particular program type, and the description of the program type(s) may differ by measure. Nevertheless, program delivery types can be generally defined according to the following baseline definitions. These are the definitions used in the measure descriptions, and, when necessary, individual measure descriptions may further refine and clarify these definitions of program delivery type.

Baseline Definitions

The energy savings for an efficiency measure is derived, in significant part, by estimating the difference between baseline efficiency and the efficiency of the measure in question. Baselines are the standard practices regarding investment in efficiency (whether measures or operations) that efficiency programs are designed to change. They address the first (gross savings) component of the question “what would have occurred absent the efficiency program?” The answer to that question is completed when making net-to-gross adjustments.

Specific measure baselines are to be covered in the TRM; however, general descriptions and guidance regarding baselines are included here.

Baselines for calculating gross savings can differ depending on the type of efficiency initiative:¹⁹

- **Time of Sale (TOS)**

¹⁹ Note that best efforts should be made to ensure that net-to-gross adjustments shall be estimated relative to the specific gross savings baselines for a given product or program.

This type of initiative is designed to influence the decision of a customer who is going to purchase a new product independent of an efficiency program, with the program only influencing the *efficiency level* of the product purchased (not whether a product would be purchased). In most cases, the baseline for time of sale initiatives is the least efficient product the customer is permitted to purchase by law (i.e. complies with state and federal product efficiency standards). However, when there is no equipment available at those legal minimums the baseline shall be adjusted to the TAC agreed efficiency that represents the least efficient products that would be commonly purchased in the Illinois market absent efficiency programs. For products for which there are no legal minimum efficiency requirements, the baseline should be the TAC agreed efficiency that represents the least efficient products that would be commonly purchased in the Illinois market absent efficiency programs.

- **New Construction (NC)**

This type of initiative is designed to influence the design and construction of new buildings and major renovations to existing buildings, including decisions regarding which products will be installed in such buildings. Note that it only covers cases in which the independent evaluator concludes that the customer was planning the new construction or major renovation project independent of an efficiency program; cases in which an efficiency program was what triggered a customer to renovate an existing building are treated under the Retrofit or Early Replacement program discussions below. The default baseline for new construction initiatives shall be the applicable efficiency codes (including state or local building codes) and/or product efficiency standards in effect at the time a permit was issued. However, if and when the TAC accepts an assessment of baseline construction practices documenting typical construction practice different than code, whether lower or higher, the results of such study will become the baseline for estimating new construction project savings.²⁰ A baseline that is lower than code can be estimated and used only when the TAC accepts study results demonstrating that the typical industry practice in some geographic regions or market segments is for construction or renovation at a level of efficiency below code.²¹

- **Early Replacement (EREP)**

This type of initiative is designed to convince customers to replace functional equipment earlier than they otherwise would. In such cases there shall be a dual baseline, with the existing equipment efficiency (i.e., the efficiency of the equipment being replaced) being the baseline for the remaining useful life of the equipment and a potentially different (typically higher) efficiency for standard *new* products (consistent with the time of sale baselines, as adjusted for any known changes to future codes or standards) being used as baseline for the remaining life of the efficiency measure. Note that for a measure to be treated as “early replacement”, the existing equipment being replaced early must be in good functioning condition or require minimal repair (i.e., it is reasonable to conclude that it could have continued to function in the absence of the program).

Additional requirements may be developed by the TAC and applied to certain measures to ensure appropriate use of early replacement assumptions, such as a maximum existing unit age, and/or to help ensure a positive cost-effectiveness result is achieved, such as requiring maximum existing unit efficiency eligible for early replacement.

²⁰ Baseline efficiency levels set above (i.e., more efficient) than a code/standard baseline are only possible for measures or measure bundles with efficiency alternatives that fall between the relevant code/standard and the efficiency requirement of the program (i.e., an “intermediate efficiency” level), and are only possible in cases where the independent evaluator determines that NTG is not capturing the impact of these intermediate efficiency levels.

²¹ This would include cases in which utility programs endeavor to improve code compliance and can measure such improvement. It would also include situations in which a compelling case could be made that a utility initiative was necessary to enable a more efficient state or local code to be adopted (at least sooner than it otherwise would have been).

Note that in addition to the above criterion, the independent evaluator must conclude that the program caused the customer to replace their existing equipment before the end of its useful life to award the additional net savings from the early replacement. Any adjustment related to this concept is handled in the net-to-gross ratio and is not addressed in gross savings.

- **Early Retirement (ERET)**

This type of initiative is designed to convince customers to remove (and not replace) equipment that would otherwise continue to remain functional (and consume energy). In such cases, the baseline is the existing efficiency of the equipment being removed. Note that for a measure to be treated as “early retirement”, the existing equipment being removed must be in good functioning condition.

- **Retrofit (RF)**

This type of initiative is designed to convince customers to add efficiency features and/or practices to energy consuming products, systems, or buildings. For such measures, the baseline is the existing level of efficiency of the products, systems or buildings to which efficiency features are being added. This is the case even if the act of adding efficiency features and/or practices triggers application of a state or local code because such a trigger would not have occurred absent the efficiency program.

Other Program Delivery Types

Additional program delivery types may have their own distinct assumptions (e.g., In Service Rates) provided within a measure characterization, for example:

- **Direct Install (DI)** - A program where measures are installed by a program representative during a site visit.
- **Efficiency Kits (KITS)** - A program where measures are provided to customers and in an Efficiency Kit and may be distributed through a number of channels (e.g. online ordering, schools, community events, trade shows, etc.).

2.4.1 Default Measure Type for Program Delivery Methods

The decision as to whether a measure is a Time of Sale or Early Replacement measure is critical to ensure the appropriate baseline is used to calculate the measure savings and the appropriate costs are applied. This decision could include consideration of:

- The functionality of or required repair cost of the existing equipment
- The age of the existing equipment and it’s estimated remaining useful life
- The role of the Program Administrator or a representative / contractor (referred herein as PA) in the decision to replace the equipment
- The importance of the incentive and/or contact with the PA in the decision to replace the equipment
- The timing of replacement in relation to regular maintenance or recapitalization upgrade schedules

The default position for measures in some common program designs are provided below, however diverging from this default is possible.

Program Type	Default Measure Type
Direct Install	Early Replacement
Audits	Early Replacement if results in replacing functioning equipment
Standard Rx Lighting Program (one-to-one fixture replacement)	Time of Sale
Standard Rx Lighting Program (lighting system redesign or delamping)	Early Replacement or Early Retirement

Program Type	Default Measure Type
Other Standard Rx Programs	Time of Sale or Retrofit
Downstream	Time of Sale
Midstream	Time of Sale
Upstream	Time of Sale

Diverging from the default could be based upon either:

- A unit by unit site specific basis as governed by guidance established by the TAC and clearly documented in the TRM, for example Residential HVAC early replacement measures require verifying the unit is functional or that required repairs cost less than 20% of the cost of a new baseline unit.
- A TAC agreed divergence could be established on a program/measure level supported by an independent evaluation to demonstrate that the presence of the incentive and/or contact with the Program (for example via targeted marketing material), was significant enough to result in the participants replacing functioning equipment that they would not otherwise have done.

It may be appropriate to apply a deemed percent split of Time of Sale and Early Replacement assumptions based on these evaluation results, noting that it may be observed that different markets or participant groups have very different deemed percentages of early replacements (e.g., low income populations are less likely to replace functioning units early without program involvement).

It is also possible that a project within a property may include both Early Replacement *and* Time of Sale measures. Classification of part of a project as Early Replacement, as defined above, does not preclude classification of another portion of the project as Time of Sale and vice versa.

3 Assumptions

The information contained in this TRM contains VEIC’s recommendations for the content of the Illinois TRM. Sources that are cited within the TRM have been chosen based on two priorities, geography and age. Whenever possible and appropriate, VEIC has incorporated Illinois-specific information into each measure characterization. The Business TRM documents from Ameren and ComEd were reviewed, as well as program and measure specific data from evaluations, efficiency plans, and working documents.

The assumptions for these characterizations rest on our understanding of the information available. In each case, the available Illinois and Midwest-specific information was reviewed, including evaluations and support material provided by the Illinois Utilities.

When Illinois or region-specific evaluations or data were not available, best practice research and data from other jurisdictions were used, often from west- and east-coast states that have allocated large amounts of funding to evaluation work and to refining their measure characterization parameters. As a result, much of the most-defensible information originates from these regions. In every case, VEIC used the most-recent, well-designed, and best-supported studies and only if it was appropriate to generalize their conclusions to the Illinois programs.

3.1 Footnotes & Documentation of Sources

Each new and updated measure characterization is supported by a work paper, which is posted to the SharePoint web site (<https://portal.veic.org>).²² Both the work paper and the measure characterizations themselves use footnotes to document the references that have been used to characterize the technology. The reference documents are too numerous to include in an Appendix and have instead been posted to the TRM’s SharePoint website. These files can be found in the ‘Sources and Reference Documents’ folder in the main directory, and are also posted to the SAG’s public web site (<http://www.ilsag.info/technical-reference-manual.html>).

3.2 General Savings Assumptions

The TRM savings estimates are expected to serve as average, representative values, or ways to calculate savings based on program-specific information. All information is presented on a per-measure basis. In using the measure-specific information in the TRM, it is helpful to keep the following notes in mind.

- All estimates of energy (kWh or therms) and peak (kW) savings are for first-year savings, not lifetime savings. Note all fossil fuel savings are presented in therms, but may be converted to other fuels using the conversion factors provided in section 3.12.1.
- Unless otherwise noted, measure life is defined by the detailed definition provided in 3.5 Glossary.
- Where deemed values for savings are provided, they represent the average energy (kWh or therms) or peak (kW) savings that could be expected from the average of all measures that might be installed in Illinois in the program year.
- In general, the baselines included in the TRM are intended to represent average conditions in Illinois. Some are based on data from the state, such as household consumption characteristics provided by the Energy Information Administration. Some are extrapolated from other areas, when Illinois data are not available.

3.3 Shifting Baseline Assumptions

The TRM anticipates the effects of changes in efficiency codes and standards on affected measures. When these changes take effect, a shift in the baseline is usually required. This complicates the measure savings estimation somewhat and will be handled in future versions of the TRM by describing the choice of and reasoning behind a shifting baseline assumption. In this version of the TRM, this applies to CFLs and T5/T8 Linear Fluorescents, Furnaces and Early Replacement Measures.

²² To gain access to the SharePoint web site, please contact the TRM Administrator at iltrmadministrator@veic.org.

3.3.1 Linear Fixture Baseline Assumptions

Linear LED Fixtures

In July 14, 2012, Federal Standards were enacted that were expected to eliminate T-12s as an option for linear fluorescent fixtures. Through v3.0 of the TRM, it was assumed that the T-12 would no longer be baseline for retrofits from 1/1/2016. However, due to significant loopholes in the legislation, T-12 compliant product is still freely available, and in Illinois T-12s continue to hold a significant share of the existing market. Therefore, measures allow T12 as an existing fixture for early replacements, with a midlife adjustment to an assumed new baseline fixture after the assumed burn out of the existing fixture.

3.3.2 Early Replacement Baseline Assumptions

A series of measures have an option to choose an Early Replacement Baseline if the following conditions are met:

- The existing unit is operational when replaced, or
- The existing unit requires minor repairs²³
- All other conditions will be considered Time of Sale.

Maximum efficiencies for measures to be considered early replacement should be determined by the program to ensure cost-effectiveness.

3.3.3 Furnace Baseline

The prior national standard for residential oil and gas furnaces was 78% AFUE. DOE raised the standard in 2007 to 80% AFUE, effective 2015. However, virtually all furnaces on the market have an AFUE of 80% or better, which prompted states and environmental and consumer groups to sue DOE over its 2007 decision. In April 2009, DOE accepted a “voluntary remand” in that litigation. In October 2009, manufacturers and efficiency advocates negotiated an agreement that, for the first time, included different standard levels in three climate regions: the North, South, and Southwest. DOE issued a direct final rule (DFR) in June 2011 reflecting the standard levels in the consensus agreement. The DFR became effective on October 25, 2011 establishing new standards: In the North, most furnaces will be required to have an AFUE of 90%. The 80% AFUE standard for the South and Southwest will remain unchanged at 80%. Oil furnaces will be required to have an AFUE of 83% in all three regions. The amended standards will become effective in May 2013 for non-weatherized furnaces and in January 2015 for weatherized furnaces. DOE estimates that the standards will save about 3.3 quads (quadrillion Btu) of energy over 30 years and yield a net present value of about \$14 billion at a 3 percent discount rate.

Update: On January 14th, 2013, the U.S. Department of Energy (DOE) proposed to settle a lawsuit brought by the American Public Gas Association (APGA) that seeks to roll back gas furnace efficiency standards. As a result, the new standards, completed in 2011 and slated to take effect in May 2013, would be eliminated in favor of yet another round of DOE hearings and studies.

A 2021 Final Interpretive Rule (“2021-01-15 Energy Conservation Program for Appliance Standards: Energy Conservation Standards for Residential Furnaces and Commercial Water Heaters; Notification of final interpretive rule”) provides the following language:

“..in the context of residential furnaces, commercial water heaters, and similarly-situated products / equipment, use of non-condensing technology (and associated venting) constitute a performance-related “feature” under the Energy Policy and Conservation Act (EPCA) that cannot be eliminated through adoption of an energy conservation standard.”

Since setting a standard of 90% would require a condensing furnace and this language indicates that non-condensing units cannot be eliminated through a standard – it is assumed that a future 90% AFUE standard is unlikely. Therefore in v10, a prior assumption that the 90% standard would be in place following the remaining useful life of an existing

²³ The Technical Advisory Committee agreed that if the cost of repair is less than 20% of the new baseline replacement cost it can be considered early replacement.

furnace has been removed.

3.4 Carryover Savings / Deferred Installs

Carryover savings, or savings from deferred installs, are defined as savings counted in the current year from measures bought or distributed in previous years. Please see the measure specific sections of the TRM to determine if the relevant lighting measure and program delivery calls for deferred installations (year 2 and year 3 installations).

Deferred installations from lighting measures are characterized in relevant sections of the TRM (currently only applicable to TLEDs in '4.5.4 LED Bulbs and Fixtures'). Broadly, the characterization is as follows:

The characterization assumes that a percentage of bulbs purchased are not installed until Year 2 and Year 3 (see ISR assumption). The Illinois Technical Advisory Committee has determined the following methodology for calculating the savings of these future installs.

Year 1 (Purchase Year) installs: *Characterized using assumptions active in the year current program year (assumptions from the year of purchase/current TRM).*

Year 2 and 3 installs: *Characterized using delta watts assumption, hours of use and interactive effects from the Install Year i.e. the actual deemed (or evaluated if available) assumptions active in Year 2 and 3 should be applied.*

The NTG factor from the Purchase Year should be applied.

Carryover savings for the current program year are derived from second year installations of program measures sold or distributed in the prior program year and third year program measure installations from two years prior to the current program year. For example, CY 2022 carryover savings result from second year installation of CY2021 lighting measures and 3rd year installations of CY2020 lighting measures.

Parameters estimates used to determine the share of carryover lamps installed in the current program year should be taken from the TRM version relevant to the actual purchase year of the carryover lamp. These parameters include in-service rate, leakage, and res/non res splits. All other gross savings parameter estimates should be taken from version of the TRM for year which the program measure was installed. (For claimed carryover in the current program year, this is the current version of the TRM).

3.5 Provisional Measures Savings Assumptions

As defined in the Glossary below, the term Provisional Measures refers to energy-efficient technologies, measures, projects, programs, and/or services that are generally nascent in Illinois or nationally, for which energy savings have not been validated through robust evaluation, measurement and verification (EM&V) efforts, and/or for which there is substantial uncertainty about their cost-effectiveness, performance, and/or customer acceptance. Because, by definition, information on savings for such measures or services is lacking, is based on limited information, or is currently subject to uncertainties, the development of robust assumptions for the TRM challenging. In order to provide calculations for use as the final applicability of these measures is being determined, the TRM can include such measures on a provisional basis, with savings estimates based on the best currently available data or approach, as determined by the IL-TRM Administrator in consultation with the TAC. In such a case, the identifying tag "Provisional Measure" will be added to the TRM measure name. Provisional Measures will be given a one-year Review Deadline, meaning that the measure will undergo a review for reasonableness, continued program relevancy, and update of material assumptions during the following TRM update cycle. The tagging of a measure in the TRM as "Provisional Measure" will ultimately be a TAC decision, and any TRM measure which the TAC determines falls into this category may be assigned.

Expectations are that the Program Administrator will work with evaluators and the TRM Administrator to design and undertake pilot studies, evaluations, or other relevant activities on an appropriate number of installations of the Provisional Measure within that year, with the goal of informing the development of more-robust and Illinois-specific savings assumptions. Including savings estimates in the TRM for such Provisional Measures provides a benchmark to assess effectiveness and allows for tracking and reporting on their value to the programs and customers, even as they are being studied. Savings from any Provisional Measure will be verified by the evaluators as per the characterization included in the TRM for up to 1% of a Program Administrator’s portfolio of savings. If savings for any single Provisional Measure rises above 1% of portfolio savings, the additional savings above 1% would be subject to retroactive evaluation risk.

3.6 Glossary

Baseline Efficiency: The assumed standard efficiency of equipment, absent an efficiency program.

Building Types:²⁴

Note where a measure installation is within a building or application that does not fit with any of the defined building types below, the user should apply custom assumptions where it is reasonable to estimate them, else the building of best fit should be used.

Building Type	Definition
Assisted Living Multifamily	Applies to residential buildings of three or more units with staff to assist the occupants. Gross Floor Area should include all fully-enclosed space within the exterior walls of the building(s) including individual rooms or units, wellness centers, exam rooms, community rooms, small shops or service areas for residents and visitors (e.g. hair salons, convenience stores), staff offices, lobbies, atriums, cafeterias, kitchens, storage areas, hallways, basements, stairways, corridors between buildings, and elevator shafts.
Auditorium/Assembly	Applies to any performance space such as a theater, arena, or hall. Gross Floor Area should include all space within the building(s), including seating, stage and backstage areas, food service areas, retail areas, rehearsal studios, administrative/office space, mechanical rooms, storage areas, elevator shafts, and stairwells.
Auto Dealership	Applies to facility space used for the retail sale of new or used cars or other vehicles. The total gross floor area should include all supporting functions such as kitchens and break rooms used by staff, storage areas (refrigerated and non-refrigerated), and administrative areas.
Childcare/Pre-school	Applies to any building providing childcare to pre-kindergarten age children.
College/University	Applies to facility space used for higher education. Relevant buildings include administrative headquarters, residence halls, athletic and recreation facilities, laboratories, etc. The total gross floor area should include all supporting functions such as kitchens used by staff, lobbies, atria, conference rooms and auditoria, fitness areas for staff, storage areas, stairways, elevator shafts, etc.
Convenience Store	Applies to facility space used for the retail sale of a limited selection of food and beverage products. The total gross floor area should include all supporting functions such as kitchens and break rooms used by staff, storage areas (refrigerated and non-refrigerated), and administrative areas.
Drug Store	Applies to facility space used for the retail sale of a pharmaceutical products, toiletries, and a limited selection of food and beverage products. The total gross floor area should include all supporting functions such as kitchens and break rooms used by staff, storage areas (refrigerated and non-refrigerated), and administrative areas.
Elementary School	Applies to a school serving children in any grades from Kindergarten through sixth grade.

²⁴ Source: US EPA, www.energystar.gov, Space Type Definitions, or definitions as developed through the Technical Advisory Committee.

Building Type	Definition
	The total gross floor area should include all supporting functions such as administrative space, conference rooms, kitchens used by staff, lobbies, cafeterias, gymnasiums, auditoria, laboratory classrooms, portable classrooms, greenhouses, stairways, atria, elevator shafts, small landscaping sheds, storage areas, etc.
Emergency Services	Applies to a building representing office, administrative, and functional space for Police/Fire/EMT style buildings. The building borrows many elements from the Low Rise Office definitions for size, envelope, occupant density, etc., but includes expanded occupancy schedules and increased equipment loads.
Exterior	Applies to unconditioned spaces that are outside of the building envelope.
Garage	Applies to unconditioned spaces either attached or detached from the primary building envelope that are not used for living space.
Grocery	Applies to facility space used for the retail sale of food and beverage products. It should not be used by restaurants. The total gross floor area should include all supporting functions such as kitchens and break rooms used by staff, storage areas (refrigerated and non-refrigerated), administrative areas, stairwells, atria, lobbies, etc.
Healthcare Clinic	Applies to a facility space used to provide diagnosis and treatment for medical, dental, or psychiatric outpatient care. Gross Floor Area should include all space within the building(s) including offices, exam rooms, laboratories, lobbies, atriums, conference rooms and auditoriums, employee break rooms and kitchens, rest rooms, elevator shafts, stairways, mechanical rooms, and storage areas.
High School/Middle School	Applies to facility space used as a school building for 7th through 12th grade students. This does not include college or university classroom facilities and laboratories, vocational, technical, or trade schools. The total gross floor area should include all supporting functions such as administrative space, conference rooms, kitchens used by staff, lobbies, cafeterias, gymnasiums, auditoria, laboratory classrooms, portable classrooms, greenhouses, stairways, atria, elevator shafts, small landscaping sheds, storage areas, etc.
Hospital	Applies to a general medical and surgical hospital (including critical access hospitals and children’s hospitals) that is either a stand-alone building or a campus of buildings. Spaces more accurately characterized as a Healthcare Clinic should use that definition. The definition of Hospital accounts for all space types that are located within the Hospital building/campus, such as medical offices, administrative offices, and skilled nursing. The total floor area should include the aggregate floor area of all buildings on the campus as well as all supporting functions such as: stairways, connecting corridors between buildings, medical offices, exam rooms, laboratories, lobbies, atria, cafeterias, storage areas, elevator shafts, and any space affiliated with emergency medical care, or diagnostic care.
Hotel/Motel Combined (All Spaces)	Applies to buildings that rent overnight accommodations on a room/suite basis, typically including a bath/shower and other facilities in guest rooms. The total gross floor area should include all interior space, including guestrooms, halls, lobbies, atria, food preparation and restaurant space, conference and banquet space, health clubs/spas, indoor pool areas, and laundry facilities, as well as all space used for supporting functions such as elevator shafts, stairways, mechanical rooms, storage areas, employee break rooms, back-of-house offices, etc. Hotel does not apply to fractional ownership properties such as condominiums or vacation timeshares. Hotel properties should be owned by a single entity and have rooms available on a nightly basis. Where distinction between Hotel and Motel is necessary: Hotel: Room entrances and Corridors are located in the <i>interior</i> of the building. Corridors are conditioned spaces. Building can be significantly larger in size/height. Motel: Room entrances and Corridors are located on the <i>exterior</i> of the building.

Building Type	Definition
	Corridors are not conditioned spaces. Buildings tend to be two to three stories in height.
Hotel/Motel Common Areas	All the common areas open to guests of the hotel such as the lobby, corridors and stairways, and other spaces that may have continuous or large lighting and HVAC hours.
Hotel/Motel Guest Room	Applies to the guest rooms of the hotel or motel. These spaces are occupied intermittently.
Low-use Small Business	Any business type with low (<3000) operating hours (provided as option in lighting measures).
Manufacturing	Applies to buildings that are dedicated to manufacturing activities. Includes light industry buildings characterized by consumer product and component manufacturing and heavy industry buildings typically characterized by a plant that includes a main production area that has high-ceilings and contains heavy equipment used for assembly line production. These building types may be distinguished by categorizing NAICS (SIC) codes according to the needs of the Program Administrator.
Miscellaneous	Applies to spaces that do not fit clearly within any available categories should be designated as “miscellaneous”.
Mobile Home	A mobile home is a prefabricated structure, built in a factory on a permanently attached chassis before being transported to site. Use single family assumptions throughout the TRM unless otherwise specified.
Movie Theater	Applies to buildings used for public or private film screenings. Gross Floor Area should include all space within the building(s), including seating areas, lobbies, concession stands, bathrooms, administrative/office space, mechanical rooms, storage areas, elevator shafts, and stairwells.
Multifamily-Mid Rise	Applies to residential buildings with up to four floors, including all public and multiuse spaces within the building envelope. Small Multifamily buildings best described as a house should use the residential measure characterizations.
Multifamily-High Rise Combined (All Spaces)	Applies to residential buildings with five or more floors, including all public and multiuse spaces within the building envelope. Gross Floor Area should include all fully-enclosed space within the exterior walls of the building(s) including living space in each unit (including occupied and unoccupied units), interior common areas (e.g. lobbies, offices, community rooms, common kitchens, fitness rooms, indoor pools), hallways, stairwells, elevator shafts, connecting corridors between buildings, storage areas, and mechanical space such as a boiler room. Open air stairwells, breezeways, and other similar areas that are not fully-enclosed should not be included in the Gross Floor Area.
Multifamily-High Rise Common Areas	All the common areas open to occupants of the building such as the lobby, corridors and stairways, and other spaces that may have continuous or high lighting and HVAC hours.
Multifamily-High Rise Residential Units	Applies to the residential units in the building only.
Office-Low Rise	Applies to facility spaces in buildings with four floors or fewer used for general office, professional, and administrative purposes. The total gross floor area should include all supporting functions such as kitchens used by staff, lobbies, atria, conference rooms and auditoria, fitness areas for staff, storage areas, stairways, elevator shafts, etc.
Office-Mid Rise	Applies to facility spaces in buildings with five to nine floors used for general office, professional, and administrative purposes. The total gross floor area should include all supporting functions such as kitchens used by staff, lobbies, atria, conference rooms and auditoria, fitness areas for staff, storage areas, stairways, elevator shafts, etc.
Office-High Rise	Applies to facility spaces in buildings with ten floors or more used for general office, professional, and administrative purposes. The total gross floor area should include all supporting functions such as kitchens used by staff, lobbies, atria, conference rooms and auditoria, fitness areas for staff, storage areas, stairways, elevator shafts, etc.
Religious	Applies to buildings that are used as places of worship. This includes churches, temples,

Building Type	Definition
Worship/Church	mosques, synagogues, meetinghouses, or any other buildings that primarily function as a place of religious worship. Gross Floor Area should include all areas inside the building that includes the primary worship area, including food preparation, community rooms, classrooms, and supporting areas such as restrooms, storage areas, hallways, and elevator shafts.
Restaurant	Applies to a subcategory of Retail/Service space that is used to provide commercial food services to individual customers, and includes kitchen, dining, and common areas.
Retail/Service- Department store	Applies to facility space used to conduct the retail sale of consumer product goods. Stores must be at least 30,000 square feet and have an exterior entrance to the public. The total gross floor area should include all supporting functions such as kitchens and break rooms used by staff, storage areas, administrative areas, elevators, stairwells, etc. Retail segments typically included under this definition are: Department Stores, Discount Stores, Supercenters, Warehouse Clubs, Dollar Stores, Home Center/Hardware Stores, and Apparel/Hard Line Specialty Stores (e.g., books, clothing, office products, toys, home goods, electronics). Retail segments excluded under this definition are: Grocery, Drug Stores, Convenience Stores, Automobile Dealerships, and Restaurants.
Retail/Service- Strip Mall	Applies to facility space used to conduct the retail sale of consumer product goods. Stores must less than 30,000 square feet and have an exterior entrance to the public. The total gross floor area should include all supporting functions such as kitchens and break rooms used by staff, storage areas, administrative areas, elevators, stairwells, etc. Retail segments excluded under this definition are: Grocery, Drug Stores, Convenience Stores, Automobile Dealerships, and Restaurants.
Warehouse	Applies to unrefrigerated or refrigerated buildings that are used to store goods, manufactured products, merchandise or raw materials. The total gross floor area of Refrigerated Warehouses should include all temperature-controlled area designed to store perishable goods or merchandise under refrigeration at temperatures below 50 degrees Fahrenheit. The total gross floor area of Unrefrigerated Warehouses should include space designed to store non-perishable goods and merchandise. Unrefrigerated warehouses also include distribution centers. The total gross floor area of refrigerated and unrefrigerated warehouses should include all supporting functions such as offices, lobbies, stairways, rest rooms, equipment storage areas, elevator shafts, etc. Existing atriums or areas with high ceilings should only include the base floor area that they occupy. The total gross floor area of refrigerated or unrefrigerated warehouse should not include outside loading bays or docks. Self-storage facilities, or facilities that rent individual storage units, are not eligible for a rating using the warehouse model.

Coincidence Factor (CF): Coincidence factors represent the fraction of connected load expected to be coincident with a particular system peak period, on a diversified basis. Coincidence factors are provided for summer peak periods.

Commercial & Industrial: The market sector that includes measures that apply to any of the building types defined in this TRM, which includes multifamily common areas and public housing.²⁵

Connected Load: The maximum wattage of the equipment, under normal operating conditions.

Deemed Value: A value that has been assumed to be representative of the average condition of an input parameter.

Default Value: When a measure indicates that an input to a prescriptive saving algorithm may take on a range of values, an average value is also provided in many cases. This value is considered the default input to the algorithm

²⁵ Measures that apply to the multifamily and public housing building types describe how to handle tenant versus master metered buildings.

and should be used when the other alternatives listed in the measure are not applicable.

End-use Category: A general term used to describe the categories of equipment that provide a service to an individual or building. See Table 2.1 for a list of the end-use categories that are incorporated in this TRM.

Energy Efficiency: "Energy efficiency" means measures that reduce the amount of electricity or natural gas consumed in order to achieve a given end use. "Energy efficiency" includes voltage optimization measures that optimize the voltage at points on the electric distribution voltage system and thereby reduce electricity consumption by electric customers' end use devices. "Energy efficiency" also includes measures that reduce the total Btus of electricity, natural gas and other fuels needed to meet the end use or uses (20 ILCS 3855/1-10). For purposes of this Section, "energy efficiency" means measures that reduce the amount of energy required to achieve a given end use. "Energy efficiency" also includes measures that reduce the total Btus of electricity and natural gas needed to meet the end use or uses (220 ILCS 5/8-104(b)).

Equivalent Full Load Hours (EFLH): The equivalent hours that equipment would need to operate at its peak capacity in order to consume its estimated annual kWh consumption (annual kWh/connected kW) or therms.

High Efficiency: General term for technologies and processes that require less energy, water, or other inputs to operate.

Lifetime: Two important distinctions fall under this definition:

Technical Lifetime: The number of years (or hours) that the new high efficiency equipment is expected to function.

Measure Lifetime: The number of years (or hours) that the new high efficiency equipment is expected to provide the savings characterized in the measure. This is the value provided in the "Deemed Lifetime of Efficient Equipment" section of each characterization. The measure lifetime is generally based on the technical lifetime but should represent an estimate of the median number of years that the measures installed under a program are still in place and operable. This may include consideration of the potential for users to remove or remodel and to allow for breakages or imperfect operation, resulting in a shorter measure life. If the savings of a population is expected to *decline* due to issues such as the overriding of settings or poorly maintaining equipment, a midlife adjustment should be used to reduce the lifetime savings;²⁶ however, the measure lifetime should still reflect the technical lifetime (i.e., the total years any savings are expected to occur). The Measure Lifetime should be used in lifetime savings and cost benefit calculations as well as in Weighted Average Measure Life (WAML) calculations.

Two additional terms used when describing a Measure Lifetime are:

Effective Useful Life (EUL) – EUL is consistent with the Measure Lifetime described above.

Remaining Useful Life (RUL) – Applies to retrofit or replacement measures. For example, if an existing working refrigerator is replaced with a high efficiency unit, the RUL is an assumption of how many more years the existing unit would have lasted. As a general rule, the RUL is usually assumed to be 1/3 of the EUL.

Load Factor (LF): The fraction of full load (wattage) for which the equipment is typically run.

Measure Cost: The incremental (for time of sale measures) or full cost (both capital and labor for retrofit measures) of implementing the High Efficiency equipment. See Section 3.8 Measure Incremental Cost Definition for full definition.

Measure Description: A detailed description of the technology and the criteria it must meet to be eligible as an energy efficient measure.

Measure: An efficient technology or procedure that results in energy savings as compared to the baseline efficiency.

²⁶ In rare cases, for example residential Home Energy Report (HER) type programs, it may be appropriate to have savings decay each year throughout the measure life rather than in a midlife adjustment.

Residential: The market sector that includes measures that apply only to detached, residential buildings or duplexes.

Operation and Maintenance (O&M) Cost Adjustments: The dollar impact resulting from differences between baseline and efficient case Operation and Maintenance costs.

Operating Hours (HOURS): The annual hours that equipment is expected to operate.

Provisional Measures: Energy-efficient technologies, measures, projects, programs, and/or services that are generally nascent in Illinois or nationally, for which energy savings have not been validated through robust evaluation, measurement, and verification (EM&V) efforts, and/or for which there is substantial uncertainty about their cost-effectiveness, performance, and/or customer acceptance.

Program: The mode of delivering a particular measure or set of measures to customers. See Section 2.4 for a list of program descriptions that are presently operating in Illinois.

Rating Period Factor (RPF): Percentages for defined times of the year that describe when energy savings will be realized for a specific measure.

Stakeholder Advisory Group (SAG): The Illinois Energy Efficiency Stakeholder Advisory Group (SAG) was first defined in the electric utilities’ first energy efficiency Plan Orders to include “... the Utility, DCEO, Staff, the Attorney General, BOMA and CUB and representation from a variety of interests, including residential consumers, business consumers, environmental and energy advocacy organizations, trades and local government... [and] a representative from the ARES (alternative retail electric supplier) community should be included.”²⁷ A group of stakeholders who have an interest in Illinois’ energy efficiency programs and who meet regularly to share information and work toward consensus on various energy efficiency issues. The Utilities in Illinois have been directed by the ICC to work with the SAG on the development of a statewide TRM.

3.7 Electrical Loadshapes (kWh)

Loadshapes are an integral part of the measure characterization and are used to divide energy savings into appropriate periods using Rating Period Factors (RPFs) such that each have variable avoided cost values allocated to them for the purpose of estimating cost effectiveness.

For the purposes of assigning energy savings (kWh) periods, the TRM TAC has agreed to use the industry standards for wholesale power market transactions as shown in the following table.

Table 3.2: On- and Off-Peak Energy Definitions

Period Category	Period Definition (Central Prevailing Time)
Winter On-Peak Energy	8AM - 11PM, weekdays, Oct – Apr, No NERC holidays
Winter Off-Peak Energy	All other hours
Summer On-Peak Energy	8AM - 11PM, weekdays, May – Sept, No NERC holidays
Summer Off-Peak Energy	All other hours

Loadshapes have been developed for each end-use by assigning Rating Period Factor percentages to each of the four periods above. Three methodologies were used:

1. Itron eShapes data for Missouri, provided by Ameren and reconciled to Illinois loads, were used to calculate the percentage of load in to the four categories above.
2. Where the Itron eShapes data did not provide a particular end-use or specific measure load profile, loadshapes that have been developed over many years by Efficiency Vermont and that have been reviewed by the Vermont Department of Public Service were adjusted to match Illinois period definitions. Note – no weather sensitive loadshapes were based on this method. Any of these load profiles that relate to High Impact Measures should be an area of future evaluation.

²⁷ ICC Docket No. 07-0540, Final Order at 32-33, February 6, 2008.
<http://www.icc.illinois.gov/downloads/public/edocket/215193.pdf>

3. Loadshapes have also been developed from primary research studies conducted in Illinois or other jurisdictions if robust datasets were available to support hourly analysis of end use consumption.

The following pages provide the loadshape values for most measures provided in the TRM.²⁸ The source of the loadshape is also provided.

²⁸ All loadshape information has been posted to the VEIC SharePoint site and is publicly accessible through the Stakeholder Advisory Group's web site. <http://www.ilsag.info/technical-reference-manual.html>
http://ilsagfiles.org/SAG_files/Technical_Reference_Manual/Residential_Loadshapes_References.zip
http://ilsagfiles.org/SAG_files/Technical_Reference_Manual/Commercial_Loadshapes_References.zip
http://ilsagfiles.org/SAG_files/Technical_Reference_Manual/Version_3/Final_Draft/Sources%20and%20References%20-%20Loadshapes/TRM_Version_3_Loadshapes_2.24.zip
http://ilsagfiles.org/SAG_files/Technical_Reference_Manual/2018_Loadshape_Files.zip

Table 3.3: Loadshapes by Season

	Loadshape Reference Number	Winter Peak	Winter Off-peak	Summer Peak	Summer Off-peak	Loadshape Source
		Oct-Apr, M-F, non-holiday, 8AM - 11PM	Oct-Apr, All other time	May-Sept, M-F, non-holiday, 8AM - 11PM	May- Sept, All other time	
Residential Clothes Washer	R01	30.1%	27.1%	23.1%	19.7%	Guidehouse MA Baseline Study ²⁹
Residential Dish Washer	R02	32.2%	28.5%	20.6%	18.7%	Guidehouse MA Baseline Study
Residential Electric DHW	R03	33.8%	31.0%	18.2%	17.1%	Guidehouse MA Baseline Study
Residential Freezer	R04	23.3%	30.2%	20.4%	26.0%	Guidehouse MA Baseline Study
Residential Refrigerator	R05	23.7%	28.7%	21.7%	25.9%	Guidehouse MA Baseline Study
Residential Indoor Lighting	R06	35.1%	26.1%	22.0%	16.8%	Opinion Dynamics IL Metering Study ³⁰
Residential Outdoor Lighting	R07	18.0%	44.1%	9.4%	28.4%	Efficiency Vermont
Residential Cooling	R08	4.1%	0.7%	71.3%	23.9%	Itron eShapes
Residential Electric Space Heat	R09	57.8%	38.8%	1.7%	1.7%	Itron eShapes
Residential Electric Heating and Cooling	R10	35.2%	22.8%	31.0%	11.0%	Itron eShapes
Residential Ventilation	R11	25.8%	32.3%	18.9%	23.0%	Efficiency Vermont
Residential - Dehumidifier	R12	12.9%	16.2%	31.7%	39.2%	Efficiency Vermont
Residential Standby Losses - Entertainment Center	R13	28.3%	30.3%	19.7%	21.7%	Guidehouse MA Baseline Study
Residential Standby Losses - Home Office	R14	28.8%	28.3%	21.4%	21.4%	Guidehouse MA Baseline Study
Residential Pool Pumps	R15	0%	0%	58.9%	41.1%	Efficiency Vermont
Residential Holiday String Lighting	R16	43.1%	56.9%	0%	0%	Estimate ³¹
Residential Electric Dryer	R17	34.0%	26.0%	22.3%	17.7%	Guidehouse MA Baseline Study
Residential Heat Pump DHW	R18	32.8%	31.1%	18.2%	17.9%	Guidehouse MA Baseline Study
Residential Electric Vehicle Charger	R19	25.6%	34.7%	16.7%	23.1%	Guidehouse Vehicle Analytics and Simulation Tool (TM), 2020
Residential Induction Cooktop	R20	18.0%	23.4%	26.0%	32.6%	Estimate

²⁹ See “RES 1 Baseline Loadshape Study” Prepared for the Electric and Gas Program Administrators of Massachusetts, Guidehouse, July 27, 2018, and corresponding Excel Appendix files.

³⁰ See ‘IL Res Indoor LED Lighting Load Shape_2018-06-06’ and ‘IL Res Indoor LED Lighting Load Shape Development Methodology_2018-05-18’ for details.

³¹ Based on average of Residential Indoor and Outdoor lighting winter usage only.

		Winter Peak	Winter Off-peak	Summer Peak	Summer Off-peak	
	Loadshape Reference Number	Oct-Apr, M-F, non-holiday, 8AM - 11PM	Oct-Apr, All other time	May-Sept, M-F, non-holiday, 8AM - 11PM	May- Sept, All other time	Loadshape Source
Commercial Electric Cooking	C01	40.6%	18.2%	28.7%	12.6%	Itron eShapes
Commercial Electric DHW	C02	40.5%	18.2%	28.5%	12.8%	Itron eShapes
Commercial Cooling	C03	4.9%	0.8%	66.4%	27.9%	Itron eShapes
Commercial Electric Heating	C04	53.5%	43.2%	1.9%	1.4%	Itron eShapes
Commercial Electric Heating and Cooling	C05	19.4%	13.5%	47.1%	19.9%	Itron eShapes
Commercial Indoor Lighting	C06	30.1%	27.5%	22.8%	19.7%	Guidehouse EmPOWER study ³²
Grocery/Conv. Store Indoor Lighting	C07	28.0%	30.2%	20.3%	21.5%	Guidehouse EmPOWER study
Health Indoor Lighting	C08	29.1%	28.9%	21.6%	20.3%	Guidehouse EmPOWER study
Office Indoor Lighting	C09	29.9%	28.2%	22.3%	19.6%	Guidehouse EmPOWER study
Restaurant Indoor Lighting	C10	32.1%	25.7%	23.4%	18.8%	Efficiency Vermont
Retail Indoor Lighting	C11	32.6%	25.4%	24.2%	17.9%	Guidehouse EmPOWER study
Warehouse Indoor Lighting	C12	26.0%	29.0%	22.4%	22.6%	Guidehouse EmPOWER study
Education Indoor Lighting	C13	34.7%	26.2%	23.6%	15.5%	Guidehouse EmPOWER study
Indust. 1-shift (8/5) (e.g., comp. air, lights)	C14	50.5%	7.2%	37.0%	5.3%	Efficiency Vermont
Indust. 2-shift (16/5) (e.g., comp. air, lights)	C15	47.5%	10.2%	34.8%	7.4%	Efficiency Vermont
Indust. 3-shift (24/5) (e.g., comp. air, lights)	C16	34.8%	23.2%	25.5%	16.6%	Efficiency Vermont
Indust. 4-shift (24/7) (e.g., comp. air, lights)	C17	25.8%	32.3%	18.9%	23.0%	Efficiency Vermont
Industrial Indoor Lighting	C18	44.3%	13.6%	32.4%	9.8%	Efficiency Vermont
Industrial Outdoor Lighting	C19	18.0%	44.1%	9.4%	28.4%	Efficiency Vermont
Commercial Outdoor Lighting	C20	16.8%	44.6%	9.3%	29.3%	Guidehouse EmPOWER study
Commercial Office Equipment	C21	37.7%	20.9%	26.7%	14.7%	Itron eShapes
Commercial Refrigeration	C22	38.5%	20.6%	26.7%	14.2%	Itron eShapes
Commercial Ventilation	C23	38.1%	20.6%	29.7%	11.6%	Itron eShapes
Traffic Signal - Red Balls, always changing or flashing	C24	25.8%	32.3%	18.9%	23.0%	Efficiency Vermont
Traffic Signal - Red Balls, changing day, off night	C25	37.0%	20.9%	27.1%	14.9%	Efficiency Vermont
Traffic Signal - Green Balls, always changing	C26	25.8%	32.3%	18.9%	23.0%	Efficiency Vermont
Traffic Signal - Green Balls, changing day, off night	C27	37.0%	20.9%	27.1%	14.9%	Efficiency Vermont
Traffic Signal - Red Arrows	C28	25.8%	32.3%	18.9%	23.0%	Efficiency Vermont

³² See '3.5 Electrical Load Shapes_IL TRM Workpape_CI_Ltg_2018-06-28' and 'IL Commercial Lighting Load Shape Development Methodology_2018-06-28' for details.

		Winter Peak	Winter Off-peak	Summer Peak	Summer Off-peak	
	Loadshape Reference Number	Oct-Apr, M-F, non-holiday, 8AM - 11PM	Oct-Apr, All other time	May-Sept, M-F, non-holiday, 8AM - 11PM	May- Sept, All other time	Loadshape Source
Traffic Signal - Green Arrows	C29	25.8%	32.3%	18.9%	23.0%	Efficiency Vermont
Traffic Signal - Flashing Yellows	C30	25.8%	32.3%	18.9%	23.0%	Efficiency Vermont
Traffic Signal - "Hand" Don't Walk Signal	C31	25.8%	32.3%	18.9%	23.0%	Efficiency Vermont
Traffic Signal - "Man" Walk Signal	C32	25.8%	32.3%	18.9%	23.0%	Efficiency Vermont
Traffic Signal - Bi-Modal Walk/Don't Walk	C33	25.8%	32.3%	18.9%	23.0%	Efficiency Vermont
Industrial Motor	C34	47.5%	10.2%	34.8%	7.4%	Efficiency Vermont
Industrial Process	C35	47.5%	10.2%	34.8%	7.4%	Efficiency Vermont
HVAC Pump Motor (heating)	C36	38.7%	48.6%	5.9%	6.8%	Efficiency Vermont
HVAC Pump Motor (cooling)	C37	7.8%	9.8%	36.8%	45.6%	Efficiency Vermont
HVAC Pump Motor (unknown use)	C38	23.2%	29.2%	21.4%	26.2%	Efficiency Vermont
VFD - Supply fans <10 HP	C39	38.8%	16.1%	28.4%	16.7%	Efficiency Vermont
VFD - Return fans <10 HP	C40	38.8%	16.1%	28.4%	16.7%	Efficiency Vermont
VFD - Exhaust fans <10 HP	C41	34.8%	23.2%	20.3%	21.7%	Efficiency Vermont
VFD - Boiler feedwater pumps <10 HP	C42	42.9%	44.2%	6.6%	6.3%	Efficiency Vermont
VFD - Chilled water pumps <10 HP	C43	11.2%	5.5%	40.7%	42.6%	Efficiency Vermont
VFD Boiler circulation pumps <10 HP	C44	42.9%	44.2%	6.6%	6.3%	Efficiency Vermont
Refrigeration Economizer	C45	36.3%	50.8%	5.6%	7.3%	Efficiency Vermont
Evaporator Fan Control	C46	24.0%	35.9%	16.7%	23.4%	Efficiency Vermont
Standby Losses - Commercial Office	C47	8.2%	50.5%	5.6%	35.7%	Efficiency Vermont
VFD Boiler draft fans <10 HP	C48	37.3%	48.9%	6.4%	7.3%	Efficiency Vermont
VFD Cooling Tower Fans <10 HP	C49	7.9%	5.2%	54.0%	32.9%	Efficiency Vermont
Engine Block Heater Timer	C50	26.5%	61.0%	4.1%	8.5%	Efficiency Vermont
Door Heater Control	C51	30.4%	69.6%	0.0%	0.0%	Efficiency Vermont
Beverage and Snack Machine Controls	C52	10.0%	48.3%	7.4%	34.3%	Efficiency Vermont
Flat	C53	36.3%	21.8%	26.2%	15.7%	Itron eShapes
Religious Indoor Lighting	C54	26.8%	31.4%	18.9%	22.8%	Efficiency Vermont
Commercial Clothes Washer	C55	47.0%	11.1%	34.0%	8.0%	Itron eShapes ³³
Dairy Farm Combined End Uses	C56	34.2%	23.9%	24.9%	17.0%	Efficiency Vermont
Milk Pump	C57	29.5%	28.9%	21.3%	20.3%	Efficiency Vermont
Farm Plate Cooler / Heat Recovery Unit	C58	22.8%	16.7%	32.4%	28.1%	Efficiency Vermont

³³ Assumed equal to R01 Residential Clothes Washer loadshape.

		Winter Peak	Winter Off-peak	Summer Peak	Summer Off-peak	
	Loadshape Reference Number	Oct-Apr, M-F, non-holiday, 8AM - 11PM	Oct-Apr, All other time	May-Sept, M-F, non-holiday, 8AM - 11PM	May- Sept, All other time	Loadshape Source
Agriculture and Water Pumping	C59	23.7%	36.0%	18.3%	22.0%	DEER 2008
Non-Residential Agriculture Lighting – 6 Hours	C60	42%	16%	30%	12%	Franklin Energy
Non-Residential Agriculture Lighting – 8 Hours	C61	36%	22%	26%	16%	Franklin Energy
Non-Residential Agriculture Lighting – 12 Hours	C62	38%	20%	27%	15%	Franklin Energy
Non-Residential Dairy Long Day Lighting – 17 Hours	C63	34%	24%	25%	17%	Franklin Energy
Non-Residential Agriculture Lighting – 24 Hours	C64	26%	33%	19%	22%	Franklin Energy
Non-Residential Indoor Agriculture Vegetative Room	C65	32%	26%	23%	19%	Franklin Energy
Non-Residential Indoor Agriculture Flowering Room	C66	31%	27%	23%	19%	Franklin Energy
Voltage Optimization – Ameren	C67	26%	30%	22%	22%	2017-2019 average utility system load for MISO Central region
Voltage Optimization – ComEd	C68	27%	29%	22%	22%	2017-2019 average utility system load for PJM ComEd region

3.8 Summer Peak Period Definition (kW)

To estimate the impact that an efficiency measure has on a utility’s system peak, the peak itself needs to be defined. Because Illinois currently is a summer peaking state, only the summer peak period is defined for the purpose of this TRM.

Note that Illinois spans two different electrical control areas, the Pennsylvania – Jersey – Maryland (PJM) Interconnection (which includes ComEd), and the Midcontinent Independent System Operator (MISO) (which includes Ameren). As a result, there is some disparity in the actual system peak across the state. However, only PJM has a forward capacity market where an efficiency program can potentially participate. Because ComEd is part of the PJM control area, their definition of the summer peak period is typically used in this TRM to support accurate quantification of demand savings for PJM Forward Capacity Market purposes.

That coincident summer peak period is defined as 1:00-5:00 PM Central Prevailing Time on non-holiday weekdays, June through August.

Summer peak coincidence factors can be found within each measure characterization. The source is provided and is based upon evaluation results, analysis of load shape data, or through a calculation using stated assumptions.

For measures that are not weather-sensitive, the summer peak coincidence factor is estimated whenever possible as the average of savings within the peak period defined above. For weather sensitive measures such as cooling, the summer peak coincidence factor is provided in two different ways. The first method is to estimate demand savings during the utility’s peak hour (defined as 3-4pm on June 20th, as provided by Ameren). This is likely to be the most indicative of actual peak benefits. The second way represents the average savings over the summer peak period, consistent with the non-weather sensitive end uses, and is presented so that savings can be bid into PJM’s Forward Capacity Market.

3.9 Heating and Cooling Degree-Day Data

Many measures are weather sensitive. Because there is a range of climactic conditions across the state, VEIC engaged the Utilities to provide their preferences for what airports and cities are the best proxies for the weather in their service territories. The result of this engagement is in the table below. All of the data represents 15-year normals from the NCEI National Climactic Data Center (NCDC).³⁴ Note that the base temperature for the calculation of heating degree-days in this document does not follow the historical 65F degree base temperature convention. Instead VEIC used several different temperatures in this TRM to more accurately reflect the outdoor temperature when a heating or cooling system turns on.

Residential heating is based on 60F, in accordance with regression analysis of heating fuel use and weather by state by the Pacific Northwest National Laboratory.³⁵ Residential cooling is based on 65F in agreement with a field study in Wisconsin.³⁶ These are lower than typical thermostat set points because internal gains, such as appliances, lighting, and people, provide some heating. In C&I settings, internal gains are often much higher; the base temperatures for both heating and cooling is 55F.³⁷ Custom degree-days with building-specific base temperatures are recommended for large C&I projects.

³⁴ 15-year normals have been used instead of Typical Meteorological Year (TMY) data due to the fact that few of the measures in the TRM are significantly affected by solar insolation, which is one of the primary benefits of using the TMY approach.

³⁵ Belzer and Cort, Pacific Northwest National Laboratory in “Statistical Analysis of Historical State-Level Residential Energy Consumption Trends,” 2004.

³⁶ Energy Center of Wisconsin, May 2008 metering study; “Central Air Conditioning in Wisconsin, A Compilation of Recent Field Research”, p. 32 (amended in 2010).

³⁷ This value is based upon experience, and it is preferable to use building-specific base temperatures when available.

Table 3.5: Degree-Day Zones and Values by Market Sector

Zone	Residential		C&I		Weather Station / City	Station ID
	HDD	CDD	HDD	CDD		
1	5,230	877	4,171	2,284	Rockford AP / Rockford	USW00094822
2	4,798	1,047	3,760	2,494	Chicago O'Hare AP / Chicago	USW00094846
3	4,266	1,183	3,296	2,761	Springfield #2 / Springfield	USC00118186
4	3,188	1,641	2,351	3,480	Belleville SIU RSCH / Belleville	USW00013802
5	3,390	1,450	2,499	3,186	Carbondale Southern IL AP / Marion	USW00093810
Average	4,631	1,098	3,619	2,596	Weighted by occupied housing units	
Base	60F	65F	55F	55F	15 year climate normals, 2006-2020	

The above assumptions based on 15-year climate normals are appropriate for use where annual consumption values are being estimated. For any peak load calculations, consideration of climate extremes or where hourly climate variations are modeled, the TAC agreed to utilize TMYx data (2007-2021) to develop variable assumptions. The specific TMYx files that are utilized is provided below:

- Zone 1: USA_IL_Rockford-Chicago.Rockford.Intl.AP.725430_TMYx.2007-2021
- Zone 2: USA_IL_Chicago.OHare.Intl.AP.725300_TMYx.2007-2021
- Zone 3: USA_IL_Springfield-Lincoln.Capital.AP.724390_TMYx.2007-2021
- Zone 4: USA_IL_Belleville.AP.724338_TMYx.2007-2021
- Zone 5: USA_IL_Marion-Williamson.County.Rgnl.AP.724339_TMYx.2007-2021

This table assigns each of the proxy cities to one of five climate zones. The following graphics from the Illinois State Water Survey show isobars (lines of equal degree-days), and we have color-coded the counties in each of these graphics using those isobars as a dividing line. Using this approach, the state divides into five cooling degree-day zones and five heating degree-day zones. Note that although the heating and cooling degree-day maps are similar, they are not the same, and the result is that there is a total of 10 climate zones in the state. The counties are listed in the tables following the figures for ease of reference. In addition, an Excel file containing all Illinois Zip Codes with the corresponding Heating and Cooling Degree-day zones is provided on the SharePoint site within the 'TRM Reference Documents' section.

Figure 3.1: Cooling Degree-Day Zones by County

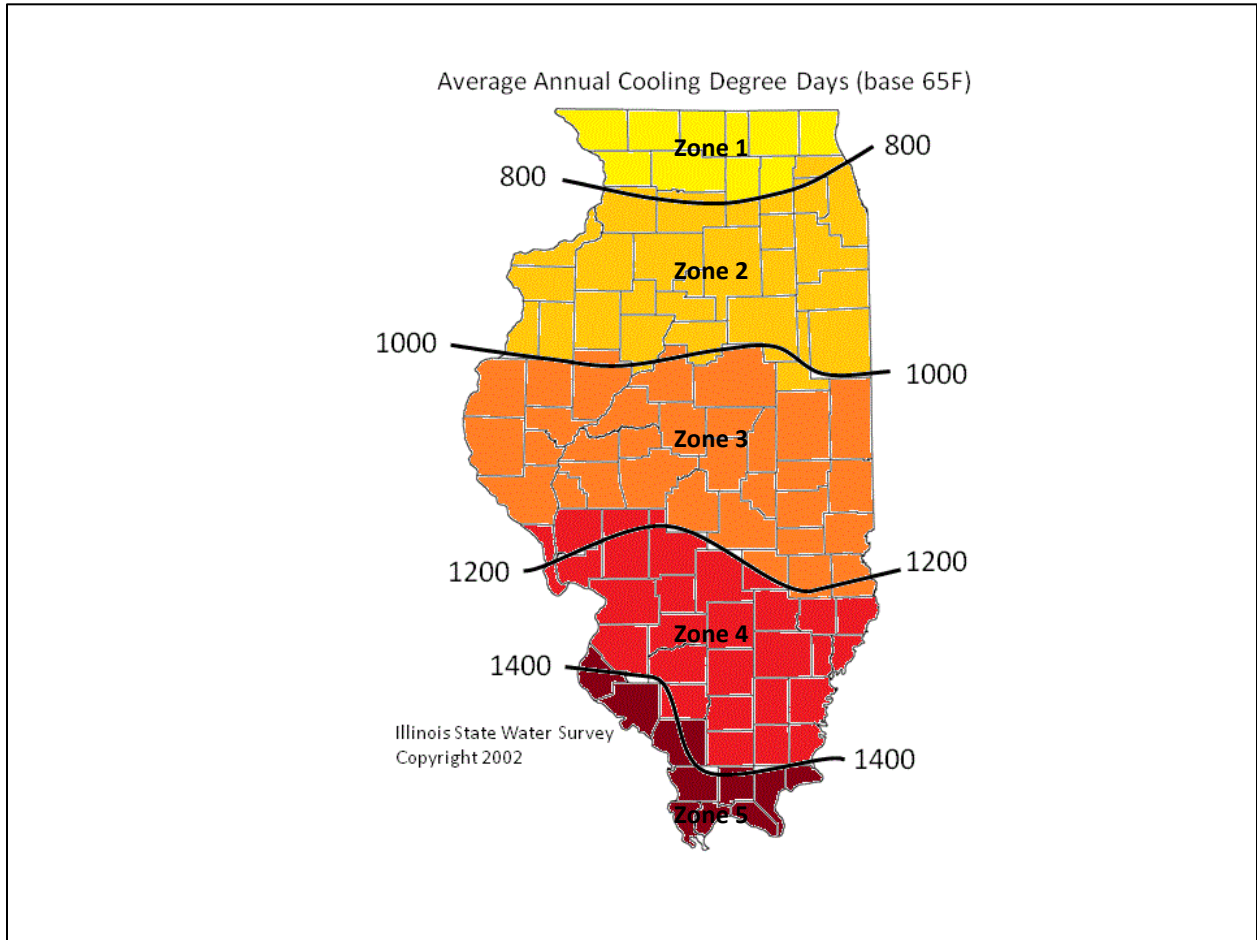

Figure 3.2: Heating Degree-Day Zones by County

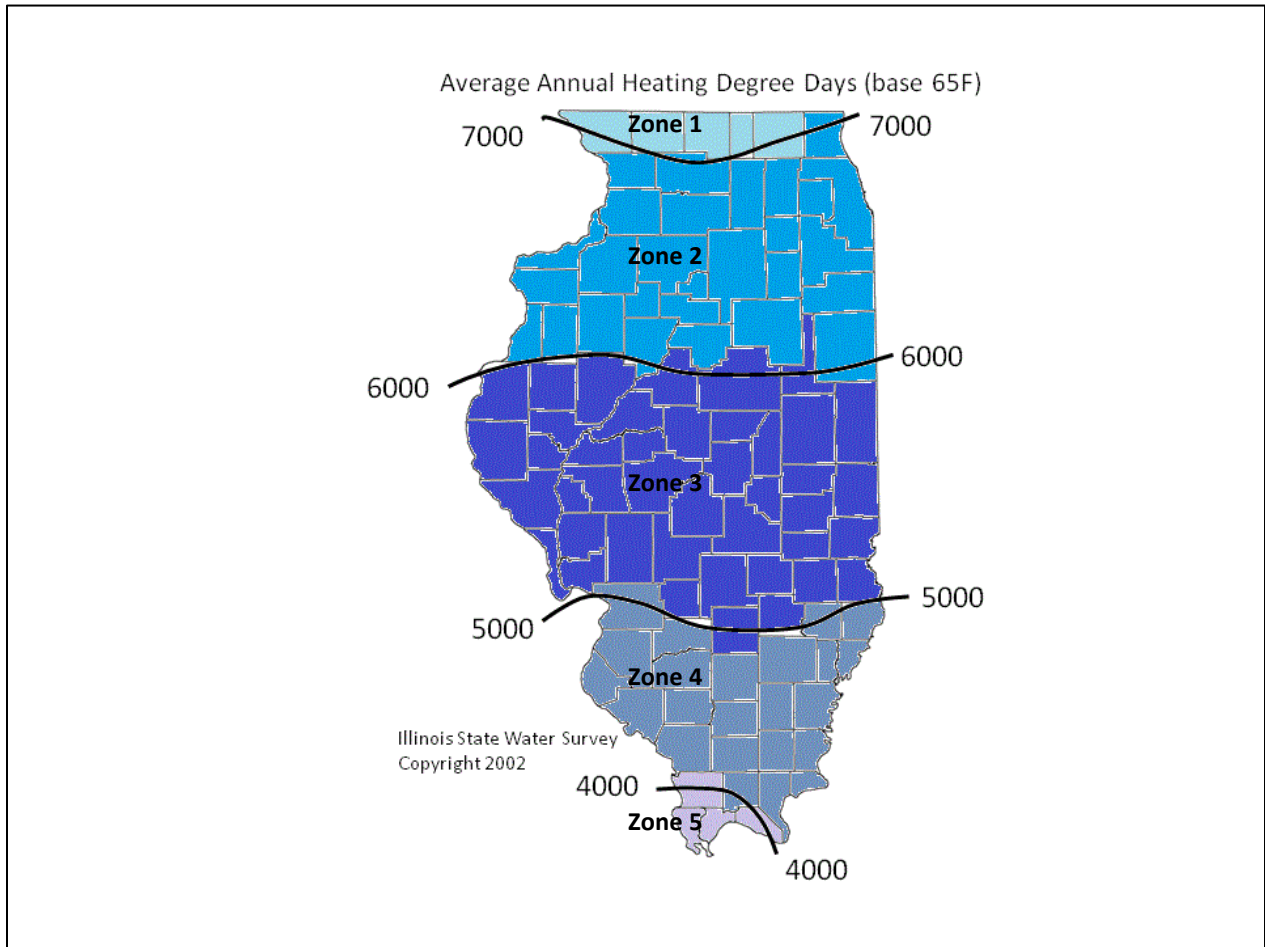

Table 3.6: Heating Degree-Day Zones by County

Zone 1	Zone 2	Zone 3	Zone 4	Zone 5
Boone County	Bureau County	Adams County	Clinton County	Alexander County
Jo Daviess County	Carroll County	Bond County	Edwards County	Massac County
Stephenson County	Cook County	Brown County	Franklin County	Pulaski County
Winnebago County	DeKalb County	Calhoun County	Gallatin County	Union County
	DuPage County	Cass County	Hamilton County	
	Grundy County	Champaign County	Hardin County	
	Henderson County	Christian County	Jackson County	
	Henry County	Clark County	Jefferson County	
	Iroquois County	Clay County	Johnson County	
	Kane County	Coles County	Lawrence County	
	Kankakee County	Crawford County	Madison County	
	Kendall County	Cumberland County	Marion County	
	Knox County	De Witt County	Monroe County	
	Lake County	Douglas County	Perry County	
	LaSalle County	Edgar County	Pope County	
	Lee County	Effingham County	Randolph County	
	Livingston County	Fayette County	Richland County	
	Marshall County	Ford County	Saline County	

Zone 1	Zone 2	Zone 3	Zone 4	Zone 5
	McHenry County	Fulton County	St. Clair County	
	Mercer County	Greene County	Wabash County	
	Ogle County	Hancock County	Washington County	
	Peoria County	Jasper County	Wayne County	
	Putnam County	Jersey County	White County	
	Rock Island County	Logan County	Williamson County	
	Stark County	Macon County		
	Warren County	Macoupin County		
	Whiteside County	Mason County		
	Will County	McDonough County		
	Woodford County	McLean County		
		Menard County		
		Montgomery		
		Morgan County		
		Moultrie County		
		Piatt County		
		Pike County		
		Sangamon County		
		Schuyler County		
		Scott County		
		Shelby County		
		Tazewell County		
		Vermilion County		

Table 3.7: Cooling Degree-day Zones by County

Zone 1	Zone 2	Zone 3	Zone 4	Zone 5
Boone County	Bureau County	Adams County	Bond County	Alexander County
Carroll County	Cook County	Brown County	Clay County	Hardin County
DeKalb County	DuPage County	Calhoun County	Clinton County	Johnson County
Jo Daviess County	Grundy County	Cass County	Edwards County	Massac County
Kane County	Henderson County	Champaign County	Fayette County	Pope County
Lake County	Henry County	Christian County	Franklin County	Pulaski County
McHenry County	Iroquois County	Clark County	Gallatin County	Randolph County
Ogle County	Kankakee County	Coles County	Hamilton County	Union County
Stephenson County	Kendall County	Crawford County	Jackson County	
Winnebago County	Knox County	Cumberland County	Jefferson County	
	LaSalle County	De Witt County	Jersey County	
	Lee County	Douglas County	Lawrence County	
	Livingston County	Edgar County	Macoupin County	
	Marshall County	Effingham County	Madison County	
	Mercer County	Ford County	Marion County	
	Peoria County	Fulton County	Monroe County	
	Putnam County	Greene County	Montgomery	
	Rock Island County	Hancock County	Perry County	
	Stark County	Jasper County	Richland County	
	Warren County	Logan County	Saline County	
	Whiteside County	Macon County	St. Clair County	
	Will County	Mason County	Wabash County	

Zone 1	Zone 2	Zone 3	Zone 4	Zone 5
	Woodford County	McDonough County	Washington County	
		McLean County	Wayne County	
		Menard County	White County	
		Morgan County	Williamson County	
		Moultrie County		
		Piatt County		
		Pike County		
		Sangamon County		
		Schuyler County		
		Scott County		
		Shelby County		
		Tazewell County		
		Vermilion County		

3.10 Measure Incremental Cost Definition

Operations and Maintenance (O&M) and/or Deferred Baseline Replacement Cost Changes: Any avoided costs are treated as benefits, and any increased costs are treated as Incremental Costs. In cases where the efficient Measure has a significantly shorter or longer life than the relevant baseline measure (e.g., LEDs versus halogens), the avoided baseline replacement measure costs should be accounted for as a benefit in the TRC test analysis.

Incremental Costs means the difference between the cost of the efficient Measure and the cost of the most relevant baseline measure that would have been installed (if any) in the absence of the efficiency program. Installation costs (material and labor) shall be included if there is a difference between the efficient Measure and the baseline measure. The Customer’s value of service lost, the Customer’s value of their lost amenity, and the Customer’s transaction costs shall be included in the TRC test analysis where a reasonable estimate or proxy of such costs can be easily obtained (e.g., Program Administrator payment to a Customer to reduce load during a demand response event, Program Administrator payment to a Customer as an inducement to give up functioning equipment). This Incremental Cost input in the TRC analysis is not reduced by the amount of any Incentives (any Financial Incentives Paid to Customers or Incentives Paid to Third Parties by a Program Administrator that is intended to reduce the price of the efficient Measure to the Customer). Incremental Cost calculations will vary depending on the type of efficient Measure being implemented, as outlined in the examples provided below and as set forth in the IL-TRM. Note that the TRM includes at least one deemed incremental cost(s) as a default value(s) for most measures. However, consistent with the TRM Policy Document policy, in instances where Program Administrators have better information on the true incremental cost of the measures (e.g., direct install programs), the Program Administrator-specific incremental cost value should be used for the purposes of cost-effectiveness analysis.

Examples of Incremental Cost calculations include:

- a. The Incremental Cost for an efficient Measure that is installed in new construction or is being purchased at the time of natural installation, investment, or replacement is the additional cost incurred to purchase an efficient Measure over and above the cost of the baseline/standard (i.e., less efficient) measure (including any incremental installation, replacement, or O&M costs if those differ between the efficient Measure and baseline measure).
- b. For a retrofit Measure where the efficiency Program caused the Customer to update their existing equipment, facility, or processes (e.g., air sealing, insulation, tank wrap, controls), where the Customer would not have otherwise made a purchase, the appropriate baseline is zero expenditure, and the Incremental Cost is the full cost of the new retrofit Measure (including installation costs).
- c. For the early replacement of functioning equipment with a new efficient Measure, where the Customer would not have otherwise made a purchase for a number of years, the appropriate baseline is a dual baseline that begins as the existing equipment and shifts to the new standard equipment after the expected remaining useful life of the existing equipment ends. Thus, the Incremental Cost is the full cost of the new

efficient Measure (including installation costs) being purchased to replace a still-functioning equipment less the present value of the assumed deferred replacement cost (including installation costs) of replacing the existing equipment with a new baseline measure at the end of the existing equipment’s life. This deferred credit may not be necessary when the lifetime of the measure is short, the costs are very low, the measure is highly cost-effective even without the deferred credit, or for other reasons (e.g., certain Direct Install Measures, Measures provided in Kits to Customers).³⁸

- d. For study-based services (e.g., facility energy audits, energy surveys, energy assessments, retro-commissioning, new construction design services), the Incremental Cost is the full cost of the study-based service. Even if the study-based service is performed entirely by a Program Administrator’s program implementation contractor, the full cost of the study-based service charged by the program implementation contractor is the Incremental Cost, because this is assumed to be the cost of the study-based service that would have been incurred by the Customer if the Customer were to have the study-based service performed in the absence of the efficiency Program. If the Customer implements efficient Measures as a result of the study-based service provided by the efficiency Program, the Incremental Cost for those efficient Measures should also be classified as Incremental Costs in the TRC analysis. Note that the Incremental Costs associated with study-based services should be included in Cost-Effectiveness calculations “only at the level at which they become variable.”³⁹ In some cases, this will be at the Measure level; in others, it will be at the Program level. Such costs should be included in Measure-level Cost-Effectiveness calculations only when they are inseparable from the efficiency improvements – i.e., when the provision of the study-based service is what produces energy savings (e.g., retro-commissioning). Conversely, when study-based service costs are separable from the costs of the efficient Measures themselves and Customer, Program Administrator and/or other parties have discretion over which of the identified efficient Measures to subsequently install (e.g., for facility energy audits, surveys or assessments that are used to identify potential efficient Measures for installation), the Incremental Cost associated with such study-based services should be included only in Program-level Cost-Effectiveness analyses (rather than allocated to individual efficient Measures).
- e. For the early retirement of functioning equipment before its expected life is over (e.g., appliance recycling Programs), the Incremental Costs are composed of the Customer’s value placed on their lost amenity, any Customer transaction costs, and the pickup and recycling cost. The Incremental Costs include the actual cost of the pickup and recycling of the equipment (often paid for by a Program Administrator to a program implementation contractor) because this is assumed to be the cost of recycling the equipment that would have been incurred by the Customer if the Customer were to recycle the equipment on their own in the absence of the efficiency Program. The payment a Program Administrator makes to the Customer serves as a proxy for the value the Customer places on their lost amenity and any Customer transaction costs.

3.11 Discount Rates, Inflation Rates, and O&M Costs

The Illinois Utilities use screening tools that apply an appropriate discount rate to any future costs or benefits. From 2022 to 2025, the societal discount rate, required for use by all electric utilities, is defined as a nominal discount rate of 2.40%, or a real (inflation-adjusted) discount rate of 0.42%.⁴⁰

Where a future cost is provided within the TRM (e.g., in early replacement measures where a deferred baseline replacement cost is provided) and the future cost has been adjusted using an inflation rate (based upon the 20-year Treasury yield of 1.98%)⁴¹, the nominal discount rate should be used to discount to the present value. Where future

³⁸ In such instances, the Incremental Cost is the full cost of direct installation Measures (materials and labor) and the full cost of Measures provided in Kits to Customers.

³⁹ See The National Efficiency Screening Project, National Standard Practice Manual for Assessing Cost-Effectiveness of Energy Efficiency Resources, Edition 1, Spring 2017. Retrieved from <https://nationalefficiencyscreening.org/national-standard-practice-manual/>.

⁴⁰ Based on the ten year average (1/1/2010 – 12/31/2019) of the 10 year Treasury bond yield rates. The 10 year rates are used to be consistent with the average measure life of the measures specified within this TRM. See “IL Discount Rate Calculation_V9-V11.xls”.

⁴¹ Calculated as $((1 + \text{Nominal Discount Rate}) / (1 + \text{Real Discount Rate}) - 1)$.

costs have not been adjusted for inflation, the real discount rate should be used to discount to present value.

The following table provides the historical discount rate that have been applied:

Program Year Applied To (TRM Based Upon)	Nominal Discount Rate	Real Discount Rate	Inflation Rate
2026 – 2029 (v14.0 – v17.0)	4.33%	2.0% ⁴² (EPA’s Social Cost of Carbon Report)	2.28% (USEIA/AEO Inflation Forecast)
2022 – 2025 (v10.0 – v13.0) ⁴³	2.40%	0.42% (10yr Treasury bond rates)	1.98%
2018 – 2021 (v6.0 – v9.0) ⁴⁴	2.38%	0.46% (10yr Treasury bond rates)	1.91%
EPY9 and GPY6 (v5.0)	Not specified	5.34% (WACC)	1.91%
EPY5-8 and GPY1-5 (v1.0 - v4.0)	Not specified	5.23% (WACC)	Not specified

As per ‘Section 8.5 Discount Rates’ of the Illinois Energy Efficiency Policy Manual, new discount and inflation rates for subsequent Plan cycles will be added to the IL-TRM as soon as available, and no later than October 1 of the year prior to the Plan filing.

Some measures specify an operations and maintenance (O&M) parameter that describes the incremental O&M cost savings that can be expected over the measure’s lifetime. For most measures the TRM does not specify the NPV of the O&M costs. Instead, the necessary information required to calculate the NPV is included. An example is provided below:

Baseline Case:	O&M costs equal \$150 every two years.
Efficient Case:	O&M costs equal \$50 every five years.

Given this information, the incremental O&M costs can be determined by discounting the cash flows in the Baseline Case and the Efficient Case separately using the real discount rate.

For a select few measures that include baseline shifts that result in multiple component costs and lifetimes over the lifetime of the measure, this standard method cannot be used. In only these cases, the O&M costs are presented both as Annual Levelized equivalent cost (i.e., the annual payment that results in an equivalent NPV to the actual stream of O&M costs) and as NPVs using a real societal discount rate of 0.42%.

When discounting nominal data that was adjusted to nominal from original real data using an inflation rate that is different than the IL-TRM inflation rate value, the analyst should first adjust for inflation using the original (non-IL-TRM) value to convert the data back to the appropriate year’s real dollars and then use the real discount rate as

⁴² All parties agree that reasonable arguments can be made to support use of either a 1.5% or 2.0% real discount rate. All parties agree to use 2.0% as a compromise value in order to avoid litigation on this issue in the EEP proceedings. All parties reserve the right to advocate for different discount rates in other analyses or proceedings before the Commerce Commission, including in future efficiency planning or reconciliation cases. No party shall use the fact that a party has agreed to this compromise position as evidence in a future proceeding concerning discount rate assumptions.

⁴³ Consistent with the IL EE Policy Manual Version 2.0, the societal discount rate used for analyses pertaining to the 2022-2025 Plan cycle will be this discount rate first presented in the 2021 IL-TRMv9.0. “The societal discount rate will be fixed for the entirety of each Plan period, and used for all analyses pertaining to that Plan period. That is, the real and/or nominal societal discount rates used in the development of the Program Administrators’ multi-year Plans shall also be used for retrospective Cost-Effectiveness analyses of the evaluated results of each of the years in those Plans as well as in the IL-TRM applicable to the years in those Plans.”

⁴⁴ Consistent with the IL EE Policy Manual Version 2.0, “The societal discount rate used for analyses pertaining to the 2018-2021 Plan cycle will be the discount rate in the 2019 IL-TRM.”

specified in the IL-TRM.

3.12 Interactive Effects

The TRM presents engineering equations for most measures. This approach is desirable because it conveys information clearly and transparently and is widely accepted in the industry. Unlike simulation model results, engineering equations also provide flexibility and the opportunity for users to substitute local, specific information for specific input values. Furthermore, the parameters can be changed in TRM updates to be applied in future years as better information becomes available.

One limitation is that some interactive effects between measures are not automatically captured. Because we cannot know what measures will be implemented at the same time with the same customer, we cannot always capture the interactions between multiple measures within individual measure characterizations. However, interactive effects with different end-uses are included in individual measure characterizations whenever possible. For instance, waste heat factors are included in the lighting characterizations to capture the interaction between more-efficient lighting measures and the amount of heating and/or cooling that is subsequently needed in the building. By contrast, no effort is made to account for interactive effects between an efficient air conditioning measure and an efficient lighting measure, because it is impossible to know the specifics of the other measure in advance of its installation.

For custom measures and projects where a bundle of measures is being implemented at the same time, these kinds of interactive effects should be estimated. Interactive effects between measures should be captured sequentially in accordance with best practice with respect to building science. For example: when building HVAC and envelope improvements are made at the same time, envelope improvement savings should be calculated first using the existing HVAC in the calculation, and the HVAC improvement savings should be calculated second assuming that the envelope improvements have already been made and the new installed HVAC capacity reflects the lower heating and cooling loads.

3.13 Electrification and Fossil Fuel Baselines (Public Act 102-0662)

On September 15, 2021, the Climate and Equitable Jobs Act (CEJA) was signed into law, effective immediately. Section 220 ILCS 5/8-103B(b-27) of CEJA states that beginning in 2022 an electric utility may:

“...offer and promote measures that electrify space heating, water heating, cooling, drying, cooking, industrial processes, and other building and industrial end uses that would otherwise be served by combustion of fossil fuel at the premises, provided that the electrification measures reduce total energy consumption at the premises. The electric utility may count the reduction in energy consumption at the premises toward achievement of its annual savings goals. The reduction in energy consumption at the premises shall be calculated as the difference between: (A) the reduction in Btu consumption of fossil fuels as a result of electrification, converted to kilowatt-hour equivalents by dividing by 3,412 Btu's per kilowatt hour; and (B) the increase in kilowatt hours of electricity consumption resulting from the displacement of fossil fuel consumption as a result of electrification measures under this subsection”.

3.13.1 Fossil Fuel Baseline Efficiencies for Electric Efficiency Measures

The energy savings for an electric efficiency measure with a fossil fuel baseline is the difference in energy consumption between the fossil fuel baseline and the efficient electric measure.

Use the following approach to define the baseline for efficient electric measures that would otherwise be served by combustion of fossil fuel at the premise:

1. If available, apply the baseline efficiency assumptions included in the TRM.

2. If not available, apply the following assumptions:
 - a. For Time of Sale and New Construction applications, apply the minimum efficiency available in Illinois on the new equipment market for the fossil fuel.
 - b. For Early Replacement:
 - i. If the existing system is known:
 1. For the remaining life of the existing equipment, use the rated efficiency of the existing system.
 2. For the remaining measure life after the existing equipment would have been replaced, use the minimum efficiency available in Illinois on the new equipment market for the fossil fuel.
 - ii. If the existing system is unknown:
 1. Use the best available information for existing equipment efficiency. If no information is available, use the minimum efficiency available in Illinois on the new equipment market for the fossil fuel.

Where a measure includes both fuel switch savings and non-fuel switch savings, the characterization will clearly separate the two types to allow appropriate tracking. In addition, a separate section entitled 'Cost Effectiveness Screening' is provided in all fuel switch measures to outline the actual meter level impacts of a fuel switch measure for use in cost effectiveness screening calculations. An example fuel switch calculation is provided below (from 5.1.10 ENERGY STAR Clothes Dryer):

An ENERGYSTAR Most Efficient Heat Pump clothes dryer with CE_{EffElec} of 5.7 purchased in place of a baseline gas dryer:

$$\begin{aligned} \text{SiteEnergySavings (MMBTUs)} &= [\text{FuelSwitchSavings}] + [\text{NonFuelSwitchSavings}] \\ \text{FuelSwitchSavings} &= \left[\frac{\text{Load}}{\text{CE}_{\text{baseGas}}} * \text{Ncycles} * \text{MMBtu_convert} * \% \text{Gas}_{\text{Gas}} \right] - \left[\frac{\text{Load}}{\text{CE}_{\text{EffElec}}} * \text{Ncycles} * \% \text{Gas}_{\text{Gas}} * 3412/1,000,000 \right] \\ &= (8.45/2.84 * 283 * 0.003412 * 0.84) - (8.45/5.7 * 283 * 0.84 * 3412/1000000) \\ &= 1.21 \text{ MMBtu} \\ \text{NonFuelSwitchSavings} &= \left[\frac{\text{Load}}{\text{CE}_{\text{baseGas}}} * \text{Ncycles} * \text{MMBtu_convert} * \% \text{Electric}_{\text{Gas}} \right] - \left[\frac{\text{Load}}{\text{CE}_{\text{EffElec}}} * \text{Ncycles} * \% \text{Electric}_{\text{Gas}} * 3412/1,000,000 \right] \\ &= (8.45/2.84 * 283 * 0.003412 * 0.16) - (8.45/5.7 * 283 * 0.16 * 3412/1000000) \\ &= 0.23 \text{ MMBtu} \\ \text{SiteEnergySavings (MMBTUs)} &= 1.21 + 0.23 \\ &= 1.44 \text{ MMBtu} \end{aligned}$$

If supported by an electric utility:

$$\begin{aligned} \Delta \text{kWh} &= \Delta \text{SiteEnergySavings} * 1,000,000 / 3,412 \\ &= 1.44 * 1,000,000/3412 \\ &= 422.5 \text{ kWh} \end{aligned}$$

Actual meter impacts are as follows (calculation methodology is provided in the Cost Effectiveness Screening section at the end of each measure with fuel switching scenarios):

$$\begin{aligned} \Delta \text{Therms} &= [\text{Gas Dryer Consumption Replaced}] \\ &= \left[\frac{\text{Load}}{\text{CE}_{\text{baseGas}}} * \text{Ncycles} * \text{Therm_convert} * \% \text{Gas}_{\text{Gas}} \right] \\ &= [8.45/2.84 * 283 * 0.03412 * 0.84] \\ &= 24.1 \text{ therms} \\ \Delta \text{kWh} &= [\text{Gas Dryer Electric Consumption Replaced}] - [\text{Electric Dryer Consumption Added}] \\ &= \left[\frac{\text{Load}}{\text{CE}_{\text{EffGas}}} * \text{Ncycles} * \% \text{Electric}_{\text{Gas}} \right] - \left[\frac{\text{Load}}{\text{CE}_{\text{EffElec}}} * \text{Ncycles} * \% \text{Electric}_{\text{Electric}} \right] \\ &= [8.45/2.84 * 283 * 0.16] - [8.45/5.7 * 283 * 1] \\ &= - 284.8 \text{ kWh} \end{aligned}$$

3.13.2 Fuel Units and Conversion Factors

Savings presented in the “Fossil Fuel Savings” section of the TRM will always be provided in Therms. Conversion to other fuel units should be based on site energy use, utilizing the conversion factors displayed below:

Fuel	Energy Units	BTUs per Energy Unit	Conversion Multiplier from Therms to Energy Unit
Natural Gas	Therms	100,000	1.0

Fuel	Energy Units	BTUs per Energy Unit	Conversion Multiplier from Therms to Energy Unit
Propane Gas	Gallons	91,333	1.095
Fuel Oil	Gallons	138,500	0.722
Diesel	Gallons	138,500	0.722
Electric	kWh	3,412	29.3

3.14 Secondary kWh Savings from Fossil Fuel Saving Measures

Up until v10, only natural gas savings were detailed within the measure characterizations. A number of measures provide secondary electric savings due to the reduction in heating consumption (for example furnace fan savings resulting from shell improvements in a fossil fuel heated home, typically labelled as kWh_heating Gas). These secondary savings can be claimed regardless of the fossil fuel in question (e.g. shell improvements to a home with oil heat) even if natural gas is specifically mentioned within the characterization.

2025 Illinois Statewide Technical Reference Manual for Energy Efficiency Version 13.0

Volume 2: Commercial and Industrial Measures

**FINAL
September 20, 2024**

**Effective:
January 1, 2025**

[INTENTIONALLY LEFT BLANK]

VOLUME 1: OVERVIEW AND USER GUIDE

4 VOLUME 2: COMMERCIAL AND INDUSTRIAL MEASURES10

4.1. Agricultural End Use 10

4.1.1 ENGINE BLOCK TIMER FOR AGRICULTURAL EQUIPMENT10

4.1.2 HIGH VOLUME LOW SPEED FANS.....13

4.1.3 HIGH SPEED FANS.....17

4.1.4 LIVESTOCK WATERER21

4.1.5 FAN THERMOSTAT CONTROLLER.....23

4.1.6 LOW PRESSURE SPRINKLER NOZZLES26

4.1.7 MILK PRE-COOLER.....28

4.1.8 VSD MILK PUMP WITH PLATE COOLER HEAT EXCHANGER.....31

4.1.9 SCROLL COMPRESSOR FOR DAIRY REFRIGERATION34

4.1.10 DAIRY REFRIGERATION HEAT RECOVERY.....37

4.1.11 COMMERCIAL LED GROW LIGHTS.....41

4.1.12 SWINE HEAT PADS.....46

4.1.13 IRRIGATION PUMP VFD50

4.1.14 HIGH EFFICIENCY GRAIN DRYER.....54

4.1.15 GRAIN DRYER TUNE-UP.....61

4.1.16 GREENHOUSE BOILER TUNE-UP66

4.1.17 GREENHOUSE THERMAL CURTAINS69

4.1.18 INFRARED FILM FOR GREENHOUSE73

4.1.19 ENERGY STAR DAIRY WATER HEATER.....76

4.1.20 COMMERCIAL ELECTRIC LAWN MOWER81

4.2. Food Service End Use..... 85

4.2.1 COMBINATION OVEN85

4.2.2 COMMERCIAL SOLID AND GLASS DOOR REFRIGERATORS & FREEZERS96

4.2.3 COMMERCIAL STEAM COOKER99

4.2.4 CONVEYOR OVEN109

4.2.5 ENERGY STAR CONVECTION OVEN.....113

4.2.6 ENERGY STAR DISHWASHER122

4.2.7 ENERGY STAR FRYER.....134

4.2.8 ENERGY STAR GRIDDLE141

4.2.9 ENERGY STAR HOT FOOD HOLDING CABINETS148

4.2.10 ICE MAKER150

4.2.11	HIGH EFFICIENCY PRE-RINSE SPRAY VALVE.....	154
4.2.12	INFRARED CHARBROILER	159
4.2.13	ROTISSERIE OVEN	162
4.2.14	INFRARED SALAMANDER BROILER	164
4.2.15	INFRARED UPRIGHT BROILER.....	166
4.2.16	KITCHEN DEMAND VENTILATION CONTROLS	168
4.2.17	PASTA COOKER	171
4.2.18	RACK OVEN - DOUBLE OVEN	173
4.2.19	ENERGY STAR ELECTRIC CONVECTION OVEN – REMOVED IN v11, CONSOLIDATED WITH 4.2.5 ENERGY STAR CONVECTION OVEN.....	176
4.2.20	EFFICIENT DIPPER WELLS	177
4.2.21	ON-DEMAND PACKAGE SEALERS – PROVISIONAL MEASURE	181
4.2.22	AUTOMATIC CONVEYOR BROILER.....	184
4.2.23	ELECTRIC DECK OVEN.....	188
4.2.24	GAS AND ELECTRIC PRESSURE FRYERS.....	191
4.2.25	EFFICIENT COOKTOPS	198
4.3.	Hot Water End Use	204
4.3.1	WATER HEATER	204
4.3.2	LOW FLOW FAUCET AERATORS	220
4.3.3	LOW FLOW SHOWERHEADS	227
4.3.4	COMMERCIAL POOL COVERS.....	233
4.3.5	TANKLESS WATER HEATER – MEASURE COMBINED WITH 4.3.1 WATER HEATER IN VERSION 8	236
4.3.6	OZONE LAUNDRY.....	237
4.3.7	MULTIFAMILY CENTRAL DOMESTIC HOT WATER PLANTS	245
4.3.8	CONTROLS FOR CENTRAL DOMESTIC HOT WATER.....	249
4.3.9	HEAT RECOVERY GREASE TRAP FILTER	254
4.3.10	DHW BOILER AND WATER HEATER TUNE-UP	258
4.3.11	TUNNEL WASHERS.....	263
4.3.12	TANK INSULATION.....	267
4.3.13	TANKLESS WATER HEATER ARRAY	271
4.4.	HVAC End Use.....	279
4.4.1	AIR CONDITIONER TUNE-UP	284
4.4.2	SPACE HEATING BOILER TUNE-UP.....	287
4.4.3	PROCESS BOILER TUNE-UP	290

4.4.4	BOILER LOCKOUT/RESET CONTROLS.....	293
4.4.5	CONDENSING UNIT HEATERS	295
4.4.6	ELECTRIC CHILLER	297
4.4.7	ENERGY STAR AND CEE TIER 2 ROOM AIR CONDITIONER	307
4.4.8	GUEST ROOM ENERGY MANAGEMENT (PTAC & PTHP)	311
4.4.9	AIR AND WATER SOURCE HEAT PUMP SYSTEMS (CENTRALLY DUCTED AND DUCTLESS)	317
4.4.10	HIGH EFFICIENCY BOILER.....	336
4.4.11	HIGH EFFICIENCY FURNACE.....	339
4.4.12	INFRARED HEATERS.....	346
4.4.13	PACKAGE TERMINAL AIR CONDITIONER (PTAC) AND PACKAGE TERMINAL HEAT PUMP (PTHP).....	349
4.4.14	PIPE INSULATION	357
4.4.15	SINGLE-PACKAGE AND SPLIT SYSTEM UNITARY AIR CONDITIONERS	375
4.4.16	STEAM TRAP REPLACEMENT OR REPAIR	388
4.4.17	VARIABLE SPEED DRIVES FOR HVAC PUMPS AND COOLING TOWER FANS	395
4.4.18	SMALL COMMERCIAL PROGRAMMABLE THERMOSTATS – RETIRED 12/31/2019. REPLACED WITH 4.4.48 SMALL COMMERCIAL THERMOSTATS.....	400
4.4.19	DEMAND CONTROLLED VENTILATION	401
4.4.20	HIGH TURNDOWN BURNER FOR SPACE HEATING BOILERS	406
4.4.21	LINKAGELESS BOILER CONTROLS FOR SPACE HEATING.....	409
4.4.22	OXYGEN TRIM CONTROLS FOR SPACE HEATING BOILERS	411
4.4.23	SHUT OFF DAMPER FOR SPACE HEATING BOILERS OR FURNACES	413
4.4.24	SMALL PIPE INSULATION	415
4.4.25	SMALL COMMERCIAL PROGRAMMABLE THERMOSTAT ADJUSTMENTS – RETIRED 12/31/2019.....	421
4.4.26	VARIABLE SPEED DRIVES FOR HVAC SUPPLY AND RETURN FANS	422
4.4.27	ENERGY RECOVERY VENTILATOR.....	428
4.4.28	STACK ECONOMIZER FOR BOILERS SERVING HVAC LOADS.....	433
4.4.29	STACK ECONOMIZER FOR BOILERS SERVING PROCESS LOADS.....	436
4.4.30	NOTCHED V BELTS FOR HVAC SYSTEMS	439
4.4.31	SMALL BUSINESS FURNACE AND ROOFTOP UNIT TUNE-UP	447
4.4.32	COMBINED HEAT AND POWER	450
4.4.33	COMMERCIAL & INDUSTRIAL AIR CURTAIN	458
4.4.34	DESTRATIFICATION FAN	469
4.4.35	ECONOMIZER REPAIR AND OPTIMIZATION	476
4.4.36	MULTI-FAMILY SPACE HEATING STEAM BOILER AVERAGING CONTROLS.....	485

4.4.37	UNITARY HVAC CONDENSING FURNACE.....	487
4.4.38	COVERS AND GAP SEALERS FOR ROOM AIR CONDITIONERS.....	495
4.4.39	HIGH TEMPERATURE HEATING AND VENTILATION (HTHV) DIRECT FIRED HEATER	503
4.4.40	GAS HIGH EFFICIENCY SINGLE PACKAGE VERTICAL AIR CONDITIONER	509
4.4.41	ADVANCED ROOFTOP CONTROLS (ARC)	513
4.4.42	ADVANCED THERMOSTATS FOR SMALL COMMERCIAL – RETIRED 12/31/2019. REPLACED WITH 4.4.48 SMALL COMMERCIAL THERMOSTATS.....	522
4.4.43	PACKAGED RTU SEALING.....	523
4.4.44	COMMERCIAL GROUND SOURCE AND GROUND WATER SOURCE HEAT PUMP	528
4.4.45	ADSORBENT AIR CLEANING.....	558
4.4.46	SERVER ROOM TEMPERATURE SET BACK	563
4.4.47	AIR DEFLECTORS FOR UNIT VENTILATORS – PROVISIONAL MEASURE – REMOVED V12.	566
4.4.48	SMALL COMMERCIAL THERMOSTATS	567
4.4.49	BOILER CHEMICAL DESCALING.....	572
4.4.50	ELECTRIC CHILLERS WITH INTEGRATED VARIABLE SPEED DRIVES – REMOVED V12.....	575
4.4.51	ADVANCED ROOFTOP CONTROLS WITH HIGH ROTOR POLE SWITCH RELUCTANCE MOTORS	576
4.4.52	HYDRONIC HEATING RADIATOR REPLACEMENT.....	588
4.4.53	HVAC SUPPLY, RETURN AND EXHAUST FANS – FAN ENERGY INDEX	592
4.4.54	PROCESS HEATING BOILER.....	598
4.4.55	COMMERCIAL GAS HEAT PUMP.....	602
4.4.56	COMMERCIAL DUCT SEALING.....	626
4.4.57	CONDENSATE RECOVERY SYSTEM	633
4.4.58	STEAM TRAP MONITORING SYSTEM	640
4.4.59	DUCTLESS HEAT PUMPS - REMOVED IN V.13	647
4.4.60	VARIABLE REFRIGERANT FLOW HVAC SYSTEM.....	648
4.4.61	CHILLER CONDENSER WATER TEMPERATURE RESET	658
4.4.62	COOLING TOWER WATER SIDE ECONOMIZER	661
4.4.63	BOILER BLOWDOWN HEAT RECOVERY	663
4.4.64	STEAM VENT CONDENSERS.....	668
4.4.65	COMPUTER ROOM AIR CONDITIONER (CRAC).....	671
4.4.66	STEAM LEAK REPAIR.....	676
4.5.	Lighting End Use	681
4.5.1	COMMERCIAL ENERGY STAR COMPACT FLUORESCENT LAMP (CFL) – RETIRED 12/31/2018, REMOVED IN V8	686
4.5.2	FLUORESCENT DELAMPING	687

4.5.3	HIGH PERFORMANCE AND REDUCED WATTAGE T8 FIXTURES AND LAMPS	691
4.5.4	LED BULBS AND FIXTURES.....	704
4.5.5	COMMERCIAL LED EXIT SIGNS	721
4.5.6	LED TRAFFIC AND PEDESTRIAN SIGNALS	724
4.5.7	LIGHTING POWER DENSITY	727
4.5.8	MISCELLANEOUS COMMERCIAL/INDUSTRIAL LIGHTING	745
4.5.9	MULTI-LEVEL LIGHTING SWITCH.....	749
4.5.10	LIGHTING CONTROLS.....	752
4.5.11	SOLAR LIGHT TUBES	759
4.5.12	T5 FIXTURES AND LAMPS	762
4.5.13	OCCUPANCY CONTROLLED BI-LEVEL LIGHTING FIXTURES	771
4.5.14	COMMERCIAL ENERGY STAR SPECIALTY COMPACT FLUORESCENT LAMP (CFL) – RETIRED 12/31/2018, REMOVED IN V8 775	
4.5.15	LED OPEN SIGN	776
4.5.16	LED STREETLIGHTING	779
4.5.17	EXTERIOR PHOTOCCELL REPAIR	782
4.5.18	ULTRA-EFFICIENT LED LIGHTING	784
4.6.	Refrigeration End Use	790
4.6.1	AUTOMATIC DOOR CLOSER FOR WALK-IN COOLERS AND FREEZERS.....	790
4.6.2	BEVERAGE AND SNACK MACHINE CONTROLS	792
4.6.3	DOOR HEATER CONTROLS FOR COOLER OR FREEZER.....	795
4.6.4	ELECTRONICALLY COMMUTATED MOTORS (ECM) FOR WALK-IN AND REACH-IN COOLERS / FREEZERS	798
4.6.5	ENERGY STAR REFRIGERATED BEVERAGE VENDING MACHINE	801
4.6.6	EVAPORATOR FAN CONTROL FOR ELECTRICALLY COMMUTATED MOTORS.....	804
4.6.7	STRIP CURTAIN FOR WALK-IN COOLERS AND FREEZERS	806
4.6.8	REFRIGERATION ECONOMIZERS	809
4.6.9	NIGHT COVERS FOR OPEN REFRIGERATED DISPLAY CASES	812
4.6.10	HIGH SPEED ROLLUP DOORS.....	815
4.6.11	Q-SYNC MOTORS FOR WALK-IN AND REACH-IN COOLERS/FREEZERS.....	820
4.6.12	VARIABLE SPEED DRIVE FOR CONDENSER FANS	827
4.6.13	ADD DOORS TO OPEN REFRIGERATED DISPLAY CASES.....	829
4.6.14	FLOATING HEAD PRESSURE CONTROL.....	834
4.6.15	ZERO ENERGY DOORS FOR REFRIGERATED CASES.....	837
4.6.16	DOOR GASKETS FOR WALK-IN AND REACH-IN COOLERS AND FREEZERS.....	840

4.7. Compressed Air End Use	843
4.7.1 VSD AIR COMPRESSOR.....	843
4.7.2 COMPRESSED AIR LOW PRESSURE DROP FILTERS	846
4.7.3 COMPRESSED AIR NO-LOSS CONDENSATE DRAINS	849
4.7.4 EFFICIENT COMPRESSED AIR NOZZLES	852
4.7.5 EFFICIENT REFRIGERATED COMPRESSED AIR DRYER.....	855
4.7.6 VORTEX TUBE THERMOSTAT - PROVISIONAL MEASURE – RETIRED 12/31/2023, REMOVED IN V12.....	858
4.7.7 EFFICIENT DESICCANT COMPRESSED AIR DRYER.....	859
4.7.8 DESICCANT DRYER DEW POINT DEMAND CONTROLS	863
4.7.9 COMPRESSED AIR HEAT RECOVERY	867
4.7.10 COMPRESSED AIR STORAGE RECEIVER TANK	870
4.7.11 REDUCE COMPRESSED AIR SETPOINT.....	874
4.7.12 AODD PUMP CONTROLS	877
4.7.13 COMPRESSED AIR LEAK REPAIR	881
4.8. Shell End Use	885
4.8.1 ROOF INSULATION FOR C&I FACILITIES	885
4.8.2 SPRING-LOADED GARAGE DOOR HINGE.....	891
4.8.3 COMMERCIAL WEATHER STRIPPING	895
4.8.4 C&I AIR SEALING	898
4.8.5 HIGH SPEED OVERHEAD DOORS	905
4.8.6 DOCK DOOR SEALS AND SHELTER	915
4.8.7 COMMERCIAL WALL INSULATION.....	923
4.8.8 COMMERCIAL SECONDARY WINDOWS.....	930
4.9. Miscellaneous End Use	936
4.9.1 PUMP OPTIMIZATION	936
4.9.2 COMPUTER POWER MANAGEMENT SOFTWARE.....	938
4.9.3 MODULATING COMMERCIAL GAS CLOTHES DRYER.....	942
4.9.4 HIGH SPEED CLOTHES WASHER.....	944
4.9.5 ENERGY STAR COMPUTERS	948
4.9.6 ADVANCED POWER STRIP – TIER 1 COMMERCIAL	951
4.9.7 HIGH EFFICIENCY TRANSFORMER	954
4.9.8 HIGH FREQUENCY BATTERY CHARGERS	958
4.9.9 COMMERCIAL CLOTHES DRYER MOISTURE SENSOR	961
4.9.10 EFFICIENT THERMAL OXIDIZERS	965

4.9.11	VARIABLE SPEED DRIVES FOR PROCESS FANS	970
4.9.12	LOW FLOW TOILETS AND URINALS	975
4.9.13	SMART IRRIGATION CONTROLS.....	978
4.9.14	SWITCH PERIPHERAL EQUIPMENT CONSOLIDATION	982
4.9.15	ENERGY STAR LOW WATTAGE UNINTERRUPTIBLE POWER SUPPLY	986
4.9.16	ENERGY EFFICIENT RECTIFIER AND HIGH WATTAGE UPS.....	990
4.9.17	ENERGY EFFICIENT HYDRAULIC OILS - PROVISIONAL MEASURE	993
4.9.18	ENERGY EFFICIENT GEAR LUBRICANTS - PROVISIONAL MEASURE	996
4.9.19	SMART SOCKETS.....	999
4.9.20	LITHIUM ION FORK TRUCK BATTERIES.....	1003
4.9.21	BUILDING OPERATOR CERTIFICATION.....	1007
4.9.22	WARM-MIX ASPHALT CHEMICAL ADDITIVES.....	1011
4.9.23	ENERGY EFFICIENT HAND DRYERS.....	1014
4.9.24	ELEVATOR MODERNIZATION	1018

VOLUME 3: RESIDENTIAL MEASURES

VOLUME 4: CROSS CUTTING MEASURES AND ATTACHMENTS

4 Volume 2: Commercial and Industrial Measures

4.1. Agricultural End Use

4.1.1 Engine Block Timer for Agricultural Equipment

DESCRIPTION

The measure is a plug-in timer that is activated below a specific outdoor temperature to control an engine block heater in agricultural equipment. Engine block heaters are typically used during cold weather to pre-warm an engine prior to start, for convenience, heaters are typically plugged in considerably longer than necessary to improve startup performance. A timer allows a user to preset the heater to come on for only the amount of time necessary to pre-warm the engine block, reducing unnecessary run time even if the baseline equipment has an engine block temperature sensor.

This measure was developed to be applicable to the following program types: RF. If applied to other program types, the measure savings should be verified.

DEFINITION OF EFFICIENT EQUIPMENT

The efficient measure is an engine block heater operated by an outdoor plug-in timer (15 amp or greater) that turns on the heater only when the outdoor temperature is below 25 °F.

DEFINITION OF BASELINE EQUIPMENT

The baseline scenario is an engine block heater that is manually plugged in by the farmer to facilitate equipment startup at a later time.

DEEMED LIFETIME OF EFFICIENT EQUIPMENT

The expected measure life is assumed to be 3 years.¹

DEEMED MEASURE COST

The incremental cost per installed plug-in timer is \$10.19.²

COINCIDENCE FACTOR

Engine block timers only operate in the winter, so the summer peak demand savings is zero.

Algorithm

CALCULATION OF SAVINGS

ELECTRIC ENERGY SAVINGS

$$\Delta kWh = ISR * Use Season * \%Days * HrSave/Day * kW_{heater} - ParaLd$$

Where:

$$ISR = \text{In Service Rate} = 78.39\%^3$$

¹ Equipment life is expected to be longer, but measure life is more conservative to account for possible attrition in use over time.

² Based on bulk pricing reported by EnSave, which administers the rebate in Vermont

³ Efficiency Vermont (EVT) Technical Reference Manual (TRM), Measure Savings Algorithms and Cost Assumptions, March 16, 2015. Based on field study conducted by Efficiency Vermont on 352 sites in Vermont and Minnesota.

Use Season = The number of days in the use season in which the temperature drops below 25°F in the state of Illinois⁴

Climate Zone (City based upon)	Use Season
1 (Rockford)	79
2 (Chicago)	68
3 (Springfield)	53
4 (Belleville)	45
5 (Marion/Murphysboro)	27
State-Wide Average	54

%Days = Proportion of days timer is used with the Use Season
= 84.23%⁵

HrSave/Day = Hours of savings per day when timer is used
= 7.765 hours per day⁶

kW_{heater} = Connected load of the engine block heater
= 1.5 kW⁷

ParaLd = Parasitic load
= 5.46 kWh⁸

For example, using the default assumptions on the installation of a timer on an engine block with a 1.5 kW heater:

$$\Delta kWh = 78.39\% * 54 \text{ days} * 84.23\% * 7.765 \text{ Hr/Day} * 1.5 \text{ kW} - 5.46 \text{ kWh}$$

$$= 409.8 \text{ kWh}$$

SUMMER COINCIDENT PEAK DEMAND SAVINGS

N/A

FOSSIL FUEL SAVINGS

N/A

WATER IMPACT DESCRIPTIONS AND CALCULATION

N/A

⁴ The number of days in the use season in which the temperature drops below 25°F in the state of Illinois. The data is sourced as an average from TMYx weather data for five different weather zones within the state, see 'Ag Op Hours_2023 – IL- Final.xlsx

⁵ EVT TRM, March 16, 2015. Based on field study conducted by EVT on 352 sites in Vermont and Minnesota.

⁶ Ibid. The hours per day saved is sourced as the difference between the baseline run hours per day without the timer, 10.66 hours, and the efficient run hours per day with the timer, 2.90 hours.

⁷ Ibid. Based on an average sized engine block heater, which typically ranges in connected load from 0.20 kW and 2 kW, as sourced from Efficiency Vermont program data.

⁸ Ibid.

DEEMED O&M COST ADJUSTMENT CALCULATION

N/A

MEASURE CODE: CI-AGE-EBLT-V03-240101

REVIEW DEADLINE: 1/1/2029

4.1.2 High Volume Low Speed Fans

DESCRIPTION

The measure applies to horizontally mounted ceiling high volume low speed (HVLS) fans that are replacing multiple non HVLS fans that have reached the end of useful life in agricultural applications.

This measure was developed to be applicable to the following program types: TOS, RF. If applied to other program types, the measure savings should be verified.

DEFINITION OF EFFICIENT EQUIPMENT

In order for this characterization to apply, the efficient equipment must be a fan with a diameter above 16 feet that meets program minimum efficiency requirements.

DEFINITION OF BASELINE EQUIPMENT

As a retrofit measure, the actual existing conditions are taken as baseline. The number and wattage of the existing fans shall be used to define baseline energy consumption. As a time of sale measure, baseline is taken as the total operating wattage of conventional fans required to match the flow rate (CFM) rating of the efficient equipment.

DEEMED LIFETIME OF EFFICIENT EQUIPMENT

The expected measure life is assumed to be 10 years.⁹

DEEMED MEASURE COST

As a retrofit measure, the actual installation cost should be used for screening and reporting purposes.

For a time of sale measure, actual full installed costs may be used along with the following baseline cost assumptions:¹⁰

Diameter of Fan (feet)	Baseline Cost
16-17.9	\$1210
18-19.9	\$1460
20-23.9	\$1840
24 +	\$2090

If actual costs are unavailable for time of sale, the incremental measure costs are as follows:¹¹

Diameter of Fan (feet)	Incremental Cost
16-17.9	\$4100
18-19.9	\$4130
20-23.9	\$4190
24 +	\$4230

LOADSHAPE

Loadshape C34 - Industrial Motor

⁹ Average motor life is calculated by dividing the estimated motor life (35,000 hours) divided by the annual run hours, taken to be the unknown/other farm commodity type of 3,259 hours (see description of default run hours on following page); and rounded down to nearest whole year. Motor life source, U.S. Department of Energy Advanced Manufacturing Office, Motor Systems Tip Sheet #3.

¹⁰ Baseline full installed costs linearly extrapolated using cost data from the Illinois ActOnEnergy TRM No. 2010-4. Midpoints were used to establish a single cost for each fan diameter category. Costs rounded up to the nearest \$10.

¹¹ Incremental costs linearly extrapolated using cost data from the Illinois ActOnEnergy TRM No. 2010-4. Midpoints were used to establish a single cost for each fan diameter category. Costs rounded up to the nearest \$10.

COINCIDENCE FACTOR

The measure has deemed kW savings therefore, a coincidence factor is not applied.

Algorithm

CALCULATION OF SAVINGS

ELECTRIC ENERGY SAVINGS

$$\Delta kWh = \frac{\sum(N_{base} * Watts_{base}) - \sum(N_{ee} * Watts_{ee})}{1000} * Hours$$

Where:

- N_{base}** = Number of baseline (conventional) fans being replaced (of equivalent wattage)
= Actual (for Retrofit projects). For time of sale projects, the number of baseline fans should be set equivalent to the number of HVLS fans being installed.
- Watt_{Sbase}** = Operating demand (W) of baseline fan
=Actual (Retrofit). For time of sale projects refer to the time of sale HVLS connected load savings table below.
- N_{ee}** = Number of efficient fans installed (of equivalent wattage)
= Actual
- Watt_{See}** = Operating demand (W) of efficient fan
= Actual (Retrofit). For time of sale projects refer to the Time of Sale HVLS connected load savings table below.

Time of Sale HVLS Connected Load Savings¹²

Diameter of Fan (feet)	Watts_base	Watts_ee
16-17.9	4497	761
18-19.9	5026	850
20-23.9	5555	940
24 +	6613	1119

Hours = Actual hours of operation. If unknown use the assumptions from the table below¹³

Facility Type	Annual Hours of Operation
Hog	3,458
Poultry	2,790
Dairy	2,455
Unknown/Other	3,133

¹² KEMA 2009 Evaluation of IPL Energy Efficiency Programs, Appendix F, Group 1 Programs, Volume 2 (Table 17). Typically, the number of baseline conventional circulation fans the HVLS fan is off-setting is not a one for one replacement scenario. Due to their more efficient design, a single HVLS fan can move and displace as much air as multiple conventional circulation fans. The baseline wattage represents the equivalent quantity of baseline fans and their wattages to match that of a single HVLS fan.

¹³ Based on NCEI/NCDC US Hourly Climate Normals data for Weather Stations in each Climate Zone, and weighted by 2010 US Census Data. The unknown/other commodity type is a weighted average of hog, poultry, and dairy facilities based on farm count as sourced from the U.S. 2017 Agriculture Census for Iowa. Dairy Farm Energy Management Guide, Southern California Edison February, 2004. The guide recommends controlling fans in order to provide maximum ventilation as necessary at 72°F and above due to heat stress concerns on cows at and above that temperature. The 67°F balance point was developed assuming a 5°F temperature band, assuming the interior temperature of the barn will be greater than that outside due to internal heat gains.

Based on default assumptions above, deemed savings for replacing one fan would be:

Facility Type	Diameter of Fan (feet)	ΔkWh
Hog	16-17.9	12,919.1
	18-19.9	14,440.6
	20-23.9	15,958.7
	24 +	18,998.3
Poultry	16-17.9	10,423.4
	18-19.9	11,651.0
	20-23.9	12,875.9
	24 +	15,328.3
Dairy	16-17.9	9,171.9
	18-19.9	10,252.1
	20-23.9	11,329.8
	24 +	13,487.8
Unknown/Other	16-17.9	11,704.9
	18-19.9	13,083.4
	20-23.9	14,458.8
	24 +	17,212.7

SUMMER COINCIDENT PEAK DEMAND SAVINGS

$$\Delta kW = \frac{\sum(-N_{base} * Watts_{base}) - \sum(N_{ee} * Watts_{ee})}{1000} * CF$$

Where:

- CF = Summer Peak Coincidence Factor
- = 100%¹⁴

Based on default assumptions above, deemed savings would be:

Facility Type	Diameter of Fan (feet)	ΔkW
Hog	16-17.9	3.74
	18-19.9	4.18
	20-23.9	4.62
	24 +	5.49
Poultry	16-17.9	3.74
	18-19.9	4.18
	20-23.9	4.62
	24 +	5.49
Dairy	16-17.9	3.74
	18-19.9	4.18
	20-23.9	4.62
	24 +	5.49
Unknown/Other	16-17.9	3.74
	18-19.9	4.18

¹⁴ Industrial Ventilation CF from eQuest.

Facility Type	Diameter of Fan (feet)	ΔkW
	20-23.9	4.62
	24 +	5.49

FOSSIL FUEL SAVINGS

N/A

WATER IMPACT DESCRIPTIONS AND CALCULATION

N/A

DEEMED O&M COST ADJUSTMENT CALCULATION

N/A

MEASURE CODE: CI-AGE-HVSF-V03-240101

REVIEW DEADLINE: 1/1/2028

4.1.3 High Speed Fans

DESCRIPTION

The measure applies to high speed exhaust, ventilation and circulation fans that are replacing an existing unit that reached the end of its useful life in agricultural applications.

Agricultural circulation fans are fans located in barns to provide air movement that helps to keep animals cool. Circulation fan efficiency is expressed as CFM¹⁵/watt and is derived from the thrust efficiency ratio (TER) in pounds force per watt (lbf/W).

Agricultural ventilation fans provide ventilation air to keep animals cool. Fan efficiency is expressed as CFM/watt and is derived from the thrust efficiency ratio (TER) in pounds force per watt (lbf/kW).

This measure was developed to be applicable to the following program types: TOS. If applied to other program types, the measure savings should be verified.

DEFINITION OF EFFICIENT EQUIPMENT

In order for this characterization to apply, the efficient equipment must be certified by BESS Labs¹⁶ with fan diameters above 12 inches that meet program minimum efficiency requirements.

Diameter of Fan (inches)	Circulation Fans IPL Minimum Efficiency (CFM/Watt)	Ventilation Fans IPL Minimum Efficiency (CFM/Watt) at (0.05 SP ¹⁷)
12-23	10.7	10.1
24-35	11.5	13.5
36-47	19.0	17.4
48+	21.5	20.3

Efficient fans are assumed to be governed by thermostatic on/off controls.

DEFINITION OF BASELINE EQUIPMENT

In order for this characterization to apply, the baseline condition is assumed to be an existing fan that reached the end of its useful life.

DEEMED LIFETIME OF EFFICIENT EQUIPMENT

The expected measure life is assumed to be 10 years for Circulation Fans¹⁸ and 7 years for Ventilation Fans¹⁹.

DEEMED MEASURE COST

Actual full installed costs may be used along with the following baseline cost assumptions:²⁰

¹⁵ Cubic Feet per Minute

¹⁶ University of Illinois, Department of Agricultural and Biological Engineering. <http://bess.illinois.edu/>

¹⁷ Static Pressure in units of inches of water

¹⁸ Average motor life is calculated by dividing the estimated motor life (35,000 hours) divided by the annual run hours, taken to be the unknown/other farm commodity type of 3,259 hours (see description of default run hours on following page); and rounded down to nearest whole year. Motor life source, U.S. Department of Energy Advanced Manufacturing Office, Motor Systems Tip Sheet #3.

¹⁹ Average motor life is calculated by dividing the estimated motor life (35,000 hours) divided by the annual run hours, taken to be the unknown/other farm commodity type of 4,800 hours (see description of default run hours on following page); and rounded down to nearest whole year. Motor life source, U.S. Department of Energy Advanced Manufacturing Office, Motor Systems Tip Sheet #3.

²⁰ Baseline full installed costs from Act on Energy Commercial Technical Reference Manual No. 2010-4. Cost for 12-23" diameter fans determined through extrapolation of costs for other fan sizes.

Diameter of Fan (inches)	Baseline Cost
12-23	\$375
24-35	\$450
36-47	\$525
48+	\$600

If actual cost not available, assume an incremental total installed cost of \$150.²¹

LOADSHAPE

Loadshape C34 - Industrial Motor

COINCIDENCE FACTOR

The measure has deemed kW savings therefore, a coincidence factor is not applied.

Algorithm

CALCULATION OF SAVINGS

ELECTRIC ENERGY SAVINGS

$$\Delta kWh = \frac{Watts_base - Watts_ee}{1000} * Hours * Nfans$$

Where:

Watts_base²² = Demand (W) of baseline fan

Diameter of Fan (inches)	Circulation Fan Watts_base	Ventilation Fan Watts_base
12-23	366	382
24-35	615	550
36-47	810	879
48+	1358	1353

Watts_ee²³ = Demand (W) of efficient fan

Diameter of Fan (inches)	Circulation Fan Watts_ee	Ventilation Fan Watts_ee (0.05 SP)
12-23	298	304
24-35	440	383
36-47	529	565
48+	993	1041

Hours²⁴ = Actual hours of operation. TBD with new climate data

Facility Type	Circulation Fan Annual Hours of Operation	Ventilation Fan Annual EFLH
Hog	3,458	4,773
Poultry	2,790	5,298

²¹ Act on Energy Commercial Technical Reference Manual No. 2010-4.

²² BESS fan database downloaded on 7/1/2015. Average watts from models below standard. AgCirculation Fans.xls

²³ BESS fan database downloaded on 7/1/2015. Average watts from models above standard. AgCirculation Fans.xls

²⁴ See "Ag Op Hours_2023.xlsx" workbook for a complete description and derivation of default operating hours. EFLH based on US Hourly Climate Normals data for weighted statewide average. The unknown/other commodity type is a weighted average of hog, poultry, and dairy facilities based on farm count as sourced from the U.S. 2017 Agriculture Census for Iowa.

Facility Type	Circulation Fan Annual Hours of Operation	Ventilation Fan Annual EFLH
Dairy	2,455	4,033
Unknown/Other	3,133	4,854

Nfans = Number of circulation fans
 = Actual

Based on default assumptions above, deemed savings would be:

Facility Type	Diameter of Fan (feet)	Circulation Fan ΔkWh	Ventilation Fan ΔkWh
Hog	12-23	235.1	372.3
	24-35	605.2	797.1
	36-47	971.7	1,498.7
	48+	1,261.2	1,489.2
Poultry	12-23	189.7	413.2
	24-35	488.3	884.8
	36-47	784.0	1,663.6
	48+	1,018.4	1,653.0
Dairy	12-23	166.9	314.6
	24-35	429.6	673.5
	36-47	689.9	1,266.4
	48+	896.1	1,258.3
Unknown/Other	12-23	213.0	378.6
	24-35	548.3	810.6
	36-47	880.4	1,524.2
	48+	1143.6	1514.5

SUMMER COINCIDENT PEAK DEMAND SAVINGS

$$\Delta kW = \frac{Watts_base - Watts_ee}{1000} * CF * Nfans$$

Where:

CF = Summer Peak Coincidence Factor
 = 100%²⁵

Based on default assumptions above, deemed savings would be:

Facility Type	Diameter of Fan (feet)	Circulation Fan ΔkW	Ventilation Fan ΔkW
Hog	12-23	0.068	0.078
	24-35	0.175	0.167
	36-47	0.281	0.314
	48+	0.365	0.312
Poultry	12-23	0.068	0.078
	24-35	0.175	0.167
	36-47	0.281	0.314

²⁵ Industrial Ventilation CF from eQuest.

Facility Type	Diameter of Fan (feet)	Circulation Fan ΔkW	Ventilation Fan ΔkW
	48+	0.365	0.312
Dairy	12-23	0.068	0.078
	24-35	0.175	0.167
	36-47	0.281	0.314
	48+	0.365	0.312
Unknown/Other	12-23	0.068	0.078
	24-35	0.175	0.167
	36-47	0.281	0.314
	48+	0.365	0.312

FOSSIL FUEL SAVINGS

N/A

WATER IMPACT DESCRIPTIONS AND CALCULATION

N/A

DEEMED O&M COST ADJUSTMENT CALCULATION

N/A

MEASURE CODE: CI-AGE-HSF-V03-240101

REVIEW DEADLINE: 1/1/2028

4.1.4 Livestock Waterer

DESCRIPTION

This measure applies to the replacement of electric open waterers with sinking or floating water heaters with equivalent herd size watering capacity of the old unit. Livestock waterers utilize electric heating elements and are used in cold climate locations in order to prevent water from freezing. Energy efficient livestock waterers, also called no or low energy livestock waterers, are closed and insulated watering containers that use lower wattage heating elements, thermostatically controlled, and water agitation (either in the form of air bubbles or floating balls), to prevent water from freezing, using less energy.

This measure was developed to be applicable to the following program types: RF, TOS. If applied to other program types, the measure savings should be verified.

DEFINITION OF EFFICIENT EQUIPMENT

In order for this characterization to apply, the efficient equipment is assumed to an electrically heated thermally insulated waterer with minimum 2 inches of insulation. A thermostat is required on unit with heating element greater than or equal to 250 watts.²⁶

DEFINITION OF BASELINE EQUIPMENT

In order for this characterization to apply, the baseline equipment is assumed to be an electric open waterer with sinking or floating water heaters that have reached the end of useful life.

DEEMED LIFETIME OF EFFICIENT EQUIPMENT

The expected measure life is assumed to be 10 years.²⁷

DEEMED MEASURE COST

For time of sale, the incremental cost is \$575²⁸. For retrofit, use actual costs.

LOADSHAPE

Loadshape C04 - Non-Residential Electric Heating

COINCIDENCE FACTOR

Heated livestock waterers only operate in the winter in order to keep water from freezing so the summer peak coincident demand savings is zero.

Algorithm

CALCULATION OF SAVINGS

ELECTRIC ENERGY SAVINGS

$$\Delta kWh = \frac{(WattsBASE - WattsEE)}{1,000} * Hours$$

Where:

WattsBASE = Power consumption of baseline equipment. Actual, if known
 = If unknown, use 1,100 for RF, 500 for TOS²⁹

²⁶ Act on Energy Commercial Technical Reference Manual No. 2010-4

²⁷ PA Consulting Group Inc. "State of Wisconsin Public Service Commission of Wisconsin Focus on Energy Evaluation Business Programs: Measure Life Study Final Report." August 25, 2009

²⁸ Internet research of leading distributors

²⁹ EnSave, Energy Efficient Stock Waterers

- WattsEE = Power consumption of efficient equipment. Actual, if known
= If unknown, use 250 for energy-efficient, 0 for energy free
- 1,000 = Kilowatt conversion factor
- Hours = Average annual run hours of heater. Actual if known.
= If unknown, use the table below³⁰

Climate Zone (City based upon)	Hours
1 (Rockford)	2,321
2 (Chicago)	2,103
3 (Springfield)	1,731
4 (Belleville)	1,362
5 (Marion/Murphysboro)	1,016
State-Wide Average	1,707

Based on default assumptions above, deemed savings would be:

Measure Type	Efficient Option	ΔkWh
Retrofit	Energy Efficient	1,451.0
	Energy Free	1,877.7
Time of Sale	Energy Efficient	426.8
	Energy Free	853.5

SUMMER COINCIDENT PEAK DEMAND SAVINGS

N/A

FOSSIL FUEL SAVINGS

N/A

WATER IMPACT DESCRIPTIONS AND CALCULATION

N/A

DEEMED O&M COST ADJUSTMENT CALCULATION

N/A

MEASURE CODE: CI-AGE-LSW1-V04-240101

REVIEW DEADLINE: 1/1/2029

³⁰ The number of days in the use season in which the temperature drops below 35°F in the state of Illinois. The data is sourced as an average from TMYx weather data for five different weather zones within the state, see 'Ag Op Hours_2023 – IL- Final.xlsx

4.1.5 Fan Thermostat Controller

DESCRIPTION

Incorporating a ventilation fan thermostat controller can reduce energy consumed where livestock is housed. Livestock ventilation fans reduce heat stress during the warmer months of the year.

For the purposes of this measure characterization, the installed ventilation fan thermostat controllers are temperature based on/off controls. While the complexity and intelligence of available controls can vary widely, where integrated controls can automate multiple modes and stages of ventilation, this measure assumes the control functionality is turning off the fan once the temperature falls to a certain point. It is recommended that other intelligent control technologies and strategies be handled through a custom approach, as these control installations require commissioning to optimize the functionality based on unique site and design considerations.

This measure was developed to be applicable to the following program types: TOS. If applied to other program types, the measure savings should be verified.

DEFINITION OF EFFICIENT EQUIPMENT

This measure applies to the incorporation of thermostatic controller for ventilation fans used in the livestock industry. To qualify, the ventilation fan must be used to modulate the temperature to reduce heat stress in a livestock facility.

DEFINITION OF BASELINE EQUIPMENT

The baseline for this measure is a non-thermostatically controlled livestock ventilation fan that operates constantly in their maximum capacity.

DEEMED LIFETIME OF EFFICIENT EQUIPMENT

The life expectancy of this measure is 15 years.³¹

DEEMED MEASURE COST

The incremental cost is estimated at \$50 per fan.³²

LOADSHAPE

Loadshape C34 – Industrial Motor

COINCIDENCE FACTOR

The savings come from a reduction in nighttime operation, so a coincidence factor is not applicable for this measure.

Algorithm

CALCULATION OF ENERGY SAVINGS

The annual energy savings are generated by the fan being disabled at temperatures below 70°F. Typically the evening hours are cooler, and the ventilation fans are not required at these lower temperatures. It is assumed, prior to retrofit, that baseline ventilation fans are operating continuously from May 1st through October 31st, encapsulating the entire portion of the year in which hot temperatures exist and the need for livestock housing ventilation is prevalent. The efficient fan operation is derived from regional TMYx data for the state of Illinois and represent, over the same timeline that was used for the baseline, the number of hours in which the temperature is above 70°F. Electric Energy Savings

³¹ Focus on Energy Evaluation Business Programs Measure Life Study: Final Report August 25, 2009, Public Service Commission of Wisconsin.

³² The measure incremental cost is sourced from the 2023 Michigan Energy Measures Database (MEMD).

$$\Delta kWh = HP_{Fan} \times LF \times C_{ME} \times \Delta Hours \div Eff_{motor}$$

Where:

- HP_{Fan} = Motor horsepower of the controlled fan
= Actual; if unknown, default to 1 horsepower³³
- LF = Fan load factor
= 0.75
- CME = 0.746 kW to HP conversion factor
- ΔHours = Reduction in fan run hours as a result of the thermostat controller, dependent on location³⁴

Zone	Hours _{Base}	Hours _{Eff}	ΔHours
Hog	6,307	4,773	1,534
Poultry	5,670	5,298	372
Dairy	4,829	4,033	795
Unknown/Other	5,937	4,854	1,083

Eff_{motor} = 82.5%³⁵, motor efficiency

For example, using the default assumptions on a 1 horsepower fan thermostat controller for a single fan on a poultry farm:

$$\begin{aligned} \Delta kWh &= 1 \text{ HP} \times 0.75 \times 0.746 \times 372 \text{ hours} / 82.5\% \text{ efficiency} \\ &= 252.3 \text{ kWh} \end{aligned}$$

SUMMER COINCIDENT PEAK DEMAND SAVINGS

N/A – Assume fans will be in operation at maximum capacity during the coincident peak demand periods, resulting in zero potential demand savings during the hottest periods of the summer.

FOSSIL FUEL SAVINGS

N/A

WATER AND OTHER NON-ENERGY IMPACT DESCRIPTIONS AND CALCULATION

N/A

DEEMED O&M COST ADJUSTMENT CALCULATION

N/A

³³ The default fan horsepower is based on a review of single- and three-phase fans listed on BESS Labs performance tested exhaust fans between 36” and 47”. The Bioenvironmental and Structural Systems (BESS) Laboratory is a research and agriculture fan product-testing lab at the University of Illinois. For more detail on the derivation of fan horsepower from BESS Lab’s fan performance archive, please see “BESS Bin Data.xlsx”.

³⁴ National Centers for Environmental Information (NCEI) Annual Normals, from 2006 - 2020, calculated with a base temp of varying degrees for different livestock, see 'Ag Op Hours_2023 - IL.xlsx for further details on fan staging temperatures.

³⁵ Table 1 with efficiency classes 60034-30 (2008), 4 Pole High Efficiency Motor, Technical note, IEC 600034-30 standard on efficiency classes for low voltage AC motors, TM)25 EN RevC 01-2-12, ABB.

MEASURE CODE: CI-AGE-FNTC-V03-240101

REVIEW DEADLINE: 1/1/2029

4.1.6 Low Pressure Sprinkler Nozzles

DESCRIPTION

Incorporating low pressure sprinkler nozzles can decrease the energy and water consumed by reducing required water supply pressure to irrigate crop fields. Low pressure sprinkler nozzles can provide uniform water application by using various orifice applications and configurations while operating at a lower pressure compared to standard, impact driven sprinkler heads. Energy savings are achieved by the irrigation system operating at a lower water pressure while maintaining the same water distribution.

This measure was developed to be applicable to the following program types: TOS. If applied to other program types, the measure savings should be verified.

DEFINITION OF EFFICIENT EQUIPMENT

Low Pressure Irrigation Nozzles operate at 35 psi or lower at rated/required flow. Annual Electric Savings obtained will be based on the number of nozzles replaced. To qualify the nozzles must operate for more than 500 hours per year and provide the equivalent flow at the reduced pressure. The maximum pump pressure must also be reduced accordingly.

DEFINITION OF BASELINE EQUIPMENT

This measure applies to the replacement of high pressure irrigation nozzles that operate at 50 psi or greater at rated/required flow.

DEEMED LIFETIME OF EFFICIENT EQUIPMENT

The life expectancy of this measure is 5 years.³⁶

DEEMED MEASURE COST

The incremental cost, including labor, is \$1.74 per nozzle.³⁷

LOADSHAPE

Loadshape C59 – Agriculture and Well Pumping

COINCIDENCE FACTOR

Coincidence Factor = 0.793³⁸

Algorithm

CALCULATION OF ENERGY SAVINGS

The annual energy savings and coincidental electric demand savings is based on PG&E research on irrigation well pumping systems and corrected based upon the type of crop, irrigated acres, and average acre-feet of water applied per acre.³⁹

ELECTRIC ENERGY SAVINGS

Annual kWh Savings = 4.06 kWh/yr/nozzle

³⁶ Measure life is sourced from DEER 2008 for permanent, solid-set low pressure sprinkler nozzles.

³⁷ The incremental cost is sourced from SCE Workpaper, SCE13WP007, Low pressure Sprinkler Nozzles, January 2013.

³⁸ Iowa Energy Efficiency Statewide TRM, Version 3.0, effective January 1, 2019

³⁹ For additional detail on the derivation of Illinois-specific savings values and how the original source material was modified and normalized into single deemed values, please see the Illinois Workpaper for this measure, "Illinois_Statewide_TRM_Workpaper_Low Pressure Sprinkler Nozzles_2019 4.1.7.docx".

SUMMER COINCIDENT PEAK DEMAND SAVINGS

Annual kW Savings = 0.0017 kW/yr/nozzle

FOSSIL FUEL SAVINGS

N/A

WATER AND OTHER NON-ENERGY IMPACT DESCRIPTIONS AND CALCULATION

N/A

DEEMED O&M COST ADJUSTMENT CALCULATION

N/A

MEASURE CODE: CI-AGE-LPSN-V02-240101

REVIEW DEADLINE: 1/1/2029

4.1.7 Milk Pre-Cooler

DESCRIPTION

There is energy savings for adding a plate heat exchanger (pre-cooler) ahead of the milk storage tank. This addresses the electrical energy savings associated with the decreased milk cooling load. Installing a pre-cooler reduces milk temperature from 100°F to 55-70°F before it enters the bulk tank.

It is important to determine if the site has an adequate supply of water, as milk plate coolers require 1 to 2 times the amount of water as compared to processed milk, to be effective. However, sites leveraging plate coolers will repurpose the warm, discharged water, either for watering cows, wash-down, or other purposes on the farm. As there are indirect benefits associated with the warmer water,⁴⁰ and because it is typically repurposed, it is assumed that there are no negative water impacts for this measure. There are also no interactive domestic hot water savings attributable to the installation of a pre-cooler as the discharged water is typically not re-directed to the existing hot water heater.

This measure was developed to be applicable to the following program types: TOS. If applied to other program types, the measure savings should be verified.

DEFINITION OF EFFICIENT EQUIPMENT

The installation of the heat exchanger to decrease the cooling requirement of the primary milk bulk tank refrigeration system. The heat exchanger fluid medium used for heat rejection is well or ground water as this produces the largest temperature differential for energy savings. For water requirements, the water supply system must have capacity to keep up with the existing farm water demands and additional demands of the pre-cooler. To minimize the volume of water used for pre-cooling, a solenoid valve should be installed on the water supply line to the pre-cooler and be actuated only when the milk pump is in operation. A bypass line around the solenoid valve or a time delay relay can also be used to provide additional cooling of the residual milk in the pre-cooler between pumping cycles. A storage tank will be necessary for used cooling water storage until it is re-used for watering cows, cleanup or another purpose on the farm.

DEFINITION OF BASELINE EQUIPMENT

The baseline conditions assume that no previous pre-cooler heat exchanger was installed and the entire milk cooling load is on the milk bulk tank.

DEEMED LIFETIME OF EFFICIENT EQUIPMENT

The life expectancy of this measure is 15 years.⁴¹

DEEMED MEASURE COST

The average equipment cost of a plate cooler is \$2,950 with an installation cost of \$494, for a total incremental measure of \$3,444.⁴²

LOADSHAPE

Loadshape C58 – Farm Plate Cooler / Heat Recovery Unit

⁴⁰ It is less stressful (metabolically) for cows to drink warmed water, and research has shown that cows will drink more water if it is warmer, leading to increased milk production. “Massachusetts Farm Energy Best Management Practices for Dairy Farms”, United States Department of Agriculture (USDA), Natural Resource Conservation Service (NRCS), 2012.

⁴¹ PA Consulting Group for the State of Wisconsin Public Service Commission, Focus on Energy Evaluation. Business Programs: Measure Life Study. Page 45 of pdf file. August 25, 2009.

⁴² The equipment and labor costs are sourced from the PG&E Workpaper – Milk Pre Cooler (PGE3PAGR114), February 2013.

COINCIDENCE FACTOR

Coincidence factor of 0.16⁴³

Algorithm

CALCULATION OF ENERGY SAVINGS

ELECTRIC ENERGY SAVINGS

Milk Pre-Cooler Heat Exchanger – Chiller Savings

$$\Delta kWh = \frac{\Delta T \times Lbs\ of\ Milk \times Cows \times C_{p,m} \times Days}{EER \times 1,000}$$

Where:

- ΔT = Change in milk temperature attributable to the pre-cooler
= 30°F⁴⁴
- Lbs of Milk = The pounds of milk produced per day that needs to be cooled
= 68 lbs of milk per cow⁴⁵
- Cows = Number of milking cows per farm
= Actual; if unknown use 101⁴⁶
- $C_{p,m}$ = Specific heat of milk
= 0.93 Btu/lb °F⁴⁷
- Days = 365 days/yr
- EER = Efficiency of the existing compressor
= 8.0 Btuh/watt⁴⁸
- 1,000 = 1,000 Watts to kW conversion factor

SUMMER COINCIDENT PEAK DEMAND SAVINGS

$$\Delta kW = \frac{\Delta kWh}{Hours} \times CF$$

Where:

⁴³ Efficiency Vermont (EVT) Technical Reference Manual (TRM), Measure Savings Algorithms and Cost Assumptions, March 16, 2015

⁴⁴ The efficacy of a milk plate cooler is sourced from Sanford, Scott (University of Wisconsin–Madison). “Energy Efficiency for Dairy Enterprises.” Presentation to Agricultural and Life Sciences Program staff. December 2014. It was assumed that there is a 25°F of milk temperature difference for a single pass plate cooler and a 35°F of temperature difference for a double/multi-pass plate cooler. For the purposes of this measure, a straight average of 30°F between the two types was used. A plate cooler reduces the overall load on the refrigeration compressors and the revised ΔT when accounting for a milk pre-cooler is 30°F less

⁴⁵ “Ag Heat Recovery Tank Supplemental Data.” WI Dairy Statistics tab shows USDA reported annual data from: U.S. Department of Agriculture. “Milk Production per Cow, Wisconsin.”

⁴⁶ The default value for the average number of milking cows per farm is sourced from the 2017 U.S. Census of Agriculture, Illinois State Summary Highlights, Full Report, Volume 1, Chapter 2, U.S. State Level. Average number of cows per farm = 93,341 cows / 924 farms.

⁴⁷ Specific heat of whole milk, Table 3: Unfrozen Composition Data, Initial Freezing Point, and Specific Heat of Foods, 2014 ASHRAE Handbook - Refrigeration. Page 19.5.

⁴⁸ Average efficiency of an existing compressor on a dairy farm, as sourced from, Massachusetts Farm Energy: Best Management Practices for Dairy Farms, USDA NRCS, 2012 (page 19).

Hours = 2920 hours⁴⁹

CF = 0.16

FOSSIL FUEL SAVINGS

N/A

WATER AND OTHER NON-ENERGY IMPACT DESCRIPTIONS AND CALCULATION

N/A

DEEMED O&M COST ADJUSTMENT CALCULATION

N/A

MEASURE CODE: CI-AGE-MLKP-V02-240101

REVIEW DEADLINE: 1/1/2029

⁴⁹ Raw milk for pasturing must be cooled with 4 hours. Assuming 2 milking per day. Dairy Farm Energy Management Guide: California, Ludington, Johnson, Kowalski, & Mage, Southern California Edison, 2004.

4.1.8 VSD Milk Pump with Plate Cooler Heat Exchanger

DESCRIPTION

This technology incorporates adding a variable speed drive to a milk transfer pump. The VSD drive reduces the heat transferred to milk during pumping operation as well increases the amount of time the milk is in the free cooling heat exchanger. The VFD regulates the milk pump in order to increase the efficacy of the plate cooler heat exchanger by slowing the flow of milk. This results in a maximum heat transfer between the warm milk and the cold water used in the plate cooler.

Energy savings are realized by the reduced load on the primary milk cooling system. A milk transfer pump VSD is only effective if paired with a plate cooler.

This measure was developed to be applicable to the following program types: TOS. If applied to other program types, the measure savings should be verified.

DEFINITION OF EFFICIENT EQUIPMENT

Installation of a new variable speed drive (VSD) on a new or existing milk transfer process pump.

DEFINITION OF BASELINE EQUIPMENT

Must have a constant speed milk transfer process pump with no existing VSD controls. A plate cooling heat exchanger can already be a part of the system, or one installed in concert with the VSD.

DEEMED LIFETIME OF EFFICIENT EQUIPMENT

The life expectancy of this measure is 15 years.⁵⁰

DEEMED MEASURE COST

The average equipment cost of a milk vacuum pump variable speed drive is \$3,871 with an installation cost of \$1,177, for a total incremental measure of \$5,048.⁵¹

LOADSHAPE

Loadshape C57 – Milk Pump

COINCIDENCE FACTOR

There are no summer coincident peak savings for VFD dairy milk pumps. Through research of refrigeration compressor power demands, no substantial evidence has arisen that any notable kW demand reduction is possible in relation to using a VFD with a milk pre-cooler to pre-cool milk that would otherwise need to be chilled through mechanical refrigeration means.

Algorithm

⁵⁰ Focus on Energy Evaluation Business Programs Measure Life Study: Final Report August 25, 2009, Public Service Commission of Wisconsin.

⁵¹ The equipment and labor costs are sourced from the PG&E Workpaper – Milk Vacuum Pump VSD, Dairy Farm Equipment (PGE3PAGR116), February 2013.

CALCULATION OF ENERGY SAVINGS

ELECTRIC ENERGY SAVINGS

$$\Delta kWh = \frac{1}{EER} \times C_{p,m} \times \Delta T \times Lbs\ of\ Milk \times Cows \times Days / 1,000$$

Where:

- EER = Efficiency of the existing compressor
= 8.0 Btu/watt⁵²
- C_{p,m} = Specific heat of milk
= 0.93 Btu/lb °F⁵³
- ΔT = Change in milk temperature as a result of the milk transfer pump VSD. This value is the additional benefits of a VSD on the milk pump over a standard plate cooler
= 11.7 °F⁵⁴
- Lbs of Milk = The pounds of milk produced per day that needs to be cooled
= 68 lbs of milk per cow⁵⁵
- Cows = Number of milking cows per farm
= Actual, if unknown use 101⁵⁶
- Days = 365.25 days of milking per year
- 1,000 = Watts to kW conversion factor

For example, using the default assumptions, the average kWh savings resulting from the installation of a milk transfer pump VSD is:

$$\Delta kWh = \frac{1}{8.0\ Btu/Watt} \times 0.93 \times 11.7^\circ F \times 68 \frac{lbs}{milk/cow} \times 101\ cows \times 365 \frac{days}{yr} / 1,000$$

$$= 3,410\ kWh$$

SUMMER COINCIDENT PEAK DEMAND SAVINGS

N/A

FOSSIL FUEL SAVINGS

N/A

⁵² Average efficiency of an existing compressor on a dairy farm, as sourced from, Massachusetts Farm Energy: Best Management Practices for Dairy Farms, USDA NRCS, 2012 (page 19)

⁵³ Specific heat of whole milk, Table 3: Unfrozen Composition Data, Initial Freezing Point, and Specific Heat of Foods, 2014 ASHRAE Handbook - Refrigeration. Page 19.5.

⁵⁴ Sanford, Scott (University of Wisconsin–Madison). “Well Water Precoolers.” Publication A37843. October 2003. It was determined that a plate cooler alone can reduce milk temperature to 68 °F and a plate cooler paired with a milk transfer pump VSD can reduce milk temperature to 56.3°F. The additional benefits of the milk transfer pump VSD over the plate cooler is 11.7°F.

⁵⁵ “Ag Heat Recovery Tank Supplemental Data.” WI Dairy Statistics tab shows USDA reported annual data from: U.S. Department of Agriculture. “Milk Production per Cow, Wisconsin.”

⁵⁶ The default value for the average number of milking cows per farm is sourced from the 2017 U.S. Census of Agriculture, Illinois State Summary Highlights, Full Report, Volume 1, Chapter 2, U.S. State Level. Average number of cows per farm = 93,341 cows / 924 farms.

WATER AND OTHER NON-ENERGY IMPACT DESCRIPTIONS AND CALCULATION

N/A

DEEMED O&M COST ADJUSTMENT CALCULATION

N/A

MEASURE CODE: CI-AGE-VSDM-V02-240101

REVIEW DEADLINE: 1/1/2029

4.1.9 Scroll Compressor for Dairy Refrigeration

DESCRIPTION

Incorporating a more efficient compressor for process milk refrigeration can decrease the energy consumed at dairy farms. This measure is for the installation of a scroll compressor to replace an existing reciprocating compressor on a milk refrigeration bulk tank. The milk refrigeration system is used to cool milk for preservation and packaging. Milk is extracted from the cow at 98°F and cooled to 38°F, resulting in a substantial load on the milk cooling equipment, which is typically the largest energy use on a dairy farm. Scroll compressors can provide increased refrigeration efficiencies with improved EERs over baseline reciprocating compressors.

The energy savings for this measure is dependent on if the site is utilizing pre-cooling equipment such as a milk plate cooler. Plate coolers can reduce the incoming temperature of the milk into the refrigeration bulk tank, reducing the overall load on the compressor and the potential savings benefits.

This measure was developed to be applicable to the following program types: TOS. If applied to other program types, the measure savings should be verified.

DEFINITION OF EFFICIENT EQUIPMENT

For an efficient scroll compressor with or without a plate cooler heat exchanger, the proposed compressor must be rated at 10.6 EER or greater on a process milk refrigeration system. The calculation assumes the cooling capacity of the compressor remains the same.

DEFINITION OF BASELINE EQUIPMENT

The baseline condition is assumed to be a reciprocating compressor.

DEEMED LIFETIME OF EFFICIENT EQUIPMENT

The expected life of this measure is 15 years.⁵⁷

DEEMED MEASURE COST

The incremental cost is \$400 per compressor.⁵⁸

LOADSHAPE

Loadshape C56 – Dairy Farm Combined End Use

COINCIDENCE FACTOR

Coincidence factor of 0.34⁵⁹

Algorithm

⁵⁷ Focus on Energy Evaluation Business Programs Measure Life Study: Final Report August 25, 2009, Public Service Commission of Wisconsin.

⁵⁸ The incremental cost is sourced from Sanford, Scott (University of Wisconsin-Madison). "Energy Efficiency for Dairy Enterprises." Presentation to Agricultural and Life Sciences Program Staff. December 2014.

⁵⁹ Efficiency Vermont (EVT) Technical Reference Manual (TRM), Measure Savings Algorithms and Cost Assumptions, March 16, 2015

CALCULATION OF ENERGY SAVINGS

ELECTRIC ENERGY SAVINGS

$$\Delta kWh = \frac{\left(\frac{1}{EER_{base}} - \frac{1}{EER_{eff}}\right) \times Process\ Load}{1,000}$$

Where:

- EER_{base} = Efficiency of the existing compressor
= 8.4 Btu/watt⁶⁰
- EER_{eff} = Efficiency of the installed, scroll compressor
= 10.6 Btu/watt⁶¹
- Process Load = $C_{p,Milk} \times \Delta T \times Lbs\ of\ Milk \times Cows \times Days$

Where:

- C_{p,Milk} = Specific heat of milk
= 0.93 Btu/lb °F⁶²
- ΔT = Change in milk temperature as result of the primary cooling system
= 60°F without a milk plate cooler⁶³
= 30°F with a milk plate cooler⁶⁴
- Lbs of Milk = The pounds of milk produced per day that needs to be cooled
= 68 lbs of milk per cow⁶⁵
- Cows = Number of milking cows per farm
= Actual; if unknown use 101⁶⁶
- Days = 365 days per year

⁶⁰ Average efficiency of a reciprocating compressor, as sourced from Wisconsin Focus on Energy TRM – Plate Heat Exchanger and Well Water Pre-Cooler, 2017

⁶¹ Average efficiency of a scroll compressor, as sourced from Massachusetts Farm Energy: Best Management Practices for Dairy Farms, USDA NRCS, 2012 (page 33)

⁶² Specific heat of whole milk, Table 3: Unfrozen Composition Data, Initial Freezing Point, and Specific Heat of Foods, 2014 ASHRAE Handbook - Refrigeration. Page 19.5.

⁶³ Safe Handling of Milk & Dairy Products. March 8th, 2017 and Sanford, Scott (University of Wisconsin–Madison). “Well Water Precoolers.” Publication A37843. October 2003. The temperature of the milk exiting the cow is considered to be 98°F and the final, cooled temperature of the milk is assumed to be 38°F.

⁶⁴ The efficacy of a milk plate cooler is sourced from Sanford, Scott (University of Wisconsin–Madison). “Energy Efficiency for Dairy Enterprises.” Presentation to Agricultural and Life Sciences Program staff. December 2014. It was assumed that there is a 25°F of milk temperature difference for a single pass plate cooler and a 35°F of temperature difference for a double/multi-pass plate cooler. For the purposes of this measure, a straight average of 30°F between the two types was used. A plate cooler reduces the overall load on the refrigeration compressors and the revised ΔT when accounting for a milk pre-cooler is 30°F less.

⁶⁵ “Ag Heat Recovery Tank Supplemental Data.” WI Dairy Statistics tab shows USDA reported annual data from: U.S. Department of Agriculture. “Milk Production per Cow, Wisconsin.”

⁶⁶ The default value for the average number of milking cows per farm is sourced from the 2017 U.S. Census of Agriculture, Illinois State Summary Highlights, Full Report, Volume 1, Chapter 2, U.S. State Level. Average number of cows per farm = 93,341 cows / 924 farms.

1,000 = 1,000 watts to kW conversion factor

For example, using the default assumptions, average kWh savings of an installed scroll compressor on the milk refrigeration bulk tank with a dairy using an existing plate cooler is:

$$\Delta kWh = \frac{\left(\frac{1}{8.4 \text{ EER}} - \frac{1}{10.6 \text{ EER}}\right) \times \frac{0.93 \text{ Btu}}{\text{lb of Milk}} \times (98^\circ\text{F} - 30^\circ\text{F} - 38^\circ\text{F}) \times 68 \frac{\text{lbs milk}}{\text{cow}} \times 101 \text{ cows} \times 365 \text{ Days}}{1,000 \text{ Watts/kW}}$$

$\Delta kWh = 1,728 \text{ kWh}$

SUMMER COINCIDENT PEAK DEMAND SAVINGS

$$\Delta kW = \frac{\Delta kWh}{\text{Hours}} \times CF$$

Where:

Hours = 2,920 hours⁶⁷
 CF = 0.34

For example, using the default assumptions, average coincident peak demand savings of an installed scroll compressor on the milk refrigeration bulk tank with a dairy using an existing plate cooler is:

$$\Delta kW = \frac{1,728 \text{ kWh}}{2,920 \text{ Hours}} \times 0.34$$

$\Delta kW = 0.201 \text{ kW}$

FOSSIL FUEL SAVINGS

N/A

WATER AND OTHER NON-ENERGY IMPACT DESCRIPTIONS AND CALCULATION

N/A

DEEMED O&M COST ADJUSTMENT CALCULATION

MEASURE CODE: CI-AGE-SCRC-V02-240101

REVIEW DEADLINE: 1/1/2029

⁶⁷ Raw milk for pasturing must be cooled with 4 hours. Assuming 2 milking per day. Dairy Farm Energy Management Guide: California, Ludington, Johnson, Kowalski, & Mage, Southern California Edison, 2004.

4.1.10 Dairy Refrigeration Heat Recovery

DESCRIPTION

A refrigeration heat recovery (RHR) unit captures waste heat from the refrigeration system and uses a heat exchange to transfer some of that heat into incoming well water. That captured waste heat is used to pre-heat ground water before it enters the primary water heater and brought to the desired final temperature needed for cleaning farm equipment. The hot compressed refrigerant is diverted and flows through the heat exchanger, attached to a secondary water tank, on its way to the condenser unit. The heat from the refrigerant is transferred through the tank into the water. Thermal buoyancy causes the warmest water to rise to the top of the tank. When hot water is used, water flows from the RHR tank into the water heater, and well water flows into the heat recovery tank. These units can assist in reducing water heating energy use by approximately 50%.⁶⁸

It is important to note that if a dairy farm installs an RHR unit and a milk plate cooler, (with or without the use of milk pump VFD control), the plate cooler will impact the savings potential of the RHR unit. The use of a plate cooler will reduce the total milk mechanical refrigeration load. Due to this refrigeration load reduction, the amount of heat rejection possible to the RHR system is diminished.

This measure was developed to be applicable to the following program types: TOS. If applied to other program types, the measure savings should be verified.

DEFINITION OF EFFICIENT EQUIPMENT

The efficient condition is farm refrigeration equipment where an RHR tank is installed and captures waste refrigerant heat from the refrigeration system compressor and transfers that waste into an RHR tank, supplied with cool ground water, through a heat exchanger before continuing through the refrigeration system condensing unit. The newly preheated water in the RHR tank is supplied into the farm’s main water heater unit, which will have a smaller temperature differential to overcome, compared to a direct ground water heater feed.

DEFINITION OF BASELINE EQUIPMENT

The baseline condition is an existing dairy farm with refrigeration equipment and a water heater unit without the use of an RHR unit to feed preheated water to the water heater. Water heater is fed directly with ground water.

DEEMED LIFETIME OF EFFICIENT EQUIPMENT

The expected useful life is 15 years.⁶⁹

DEEMED MEASURE COST

The incremental cost is \$4,353.⁷⁰

LOADSHAPE

Loadshape C58 – Farm Plate Cooler / Heat Recovery Unit

COINCIDENCE FACTOR

There are no summer coincident peak savings for RHR units. It is assumed that electric water heaters have a single element and will still be used to heat water up to full temperature, and that the kW rating is unchanged when an RHR unit is added in the water heating loop (resulting in no demand reduction).

Algorithm

⁶⁸ U.S. Department of Agriculture, Natural Resources Conservation Service. “Energy Self-Assessment: Refrigeration Heat Recovery.” Accessed April 27th, 2023.

⁶⁹ PA Consulting Group Inc. “State of Wisconsin Public Service Commission of Wisconsin Focus on Energy Evaluation Business Programs: Measure Life Study Final Report.” August 25, 2009.

⁷⁰ The incremental cost is sourced from Efficiency Vermont custom project data based on actual equipment installs between 2010 and 2017.

CALCULATION OF ENERGY SAVINGS

ELECTRIC ENERGY SAVINGS

$$\Delta kWh = Btu_{Recovered} * Days * \left(\frac{1}{EF_{elec}} \right) / 3,412$$

Where:

$$Btu_{Recovered} = Btu_{Milk\ Potential} \text{ or } Btu_{RHR\ Storage} \text{ (lesser of the two)}$$

Where:

$$Btu_{Milk\ Potential} = Lbs\ of\ Milk * Cows * C_{P,Milk} * \Delta T_{Milk} * SF$$

and

$$Btu_{Storage} = Hot\ Water * C_{P,Water} * P_{Water} * \Delta T_{Water}$$

- Days = Number of milking days per year
= 365.25 days⁷¹
- 3,412 = Btu to kWh electric conversion factor
- EF_{elec} = Energy factor for a standard electric water heater
= 90%⁷²
- Lbs of Milk = The pounds of milk produced per day per cow that needs to be cooled
=68 lbs of milk per cow⁷³
- Cows = Number of milking cows per farm
= Actual, if unknown use 101⁷⁴
- C_{P,Milk} = Specific heat of milk
= 0.93 Btu/(lb-°F) ⁷⁵
- ΔT_{Milk} = Change in milk temperature
= °F_{IN} - °F_{FINAL}
°F_{IN} = Temperature of milk being supplied that needs to be cooled

⁷¹ Wisconsin Milk Marketing Board. "Did You Know? Website: Milking Every Day." Accessed December 21, 2015

⁷² Talbot, Jacob (American Council for an Energy-Efficient Economy). ACEEE Report A121: Market Transformation Efforts for Water Heating Efficiency. January 2012.

⁷³ "Ag Heat Recovery Tank Supplemental Data." WI Dairy Statistics tab shows USDA reported annual data from: U.S. Department of Agriculture. "Milk Production per Cow, Wisconsin."

⁷⁴ The default value for the average number of milking cows per farm is sourced from the 2017 U.S. Census of Agriculture, Illinois State Summary Highlights, Full Report, Volume 1, Chapter 2, U.S. State Level. Average number of cows per farm = 93,341 cows / 924 farms.

⁷⁵ Specific heat of whole milk, Table 3: Unfrozen Composition Data, Initial Freezing Point, and Specific Heat of Foods, 2014 ASHRAE Handbook - Refrigeration. Page 19.5.

= 98°F if no pre-cooler is used in operation; 68°F if a milk pre-cooler is used;⁷⁶
 56.3°F if a milk pre-cooler and VFD milk transfer pump are used.⁷⁷

$^{\circ}\text{F}_{\text{FINAL}}$ = Final stored temperature of cooled milk
 = 38°F

SF = Savings factor for the percentage of energy able to be captured from the milk cooling process
 = 55%⁷⁸

Hot Water = Amount of hot water per day in gallons that the site uses for washing and cleaning purposes
 = 131.7 gallons⁷⁹

$C_{p,\text{Water}}$ = Specific heat of water
 = 1 Btu/lb-°F

P_{Water} = Density of water
 = 8.34 lbs/gallon

ΔT_{Water} = Temperature difference = $\text{Temp}_{\text{warm water}} - \text{Temp}_{\text{cold water}}$

$\text{Temp}_{\text{warm water}}$ = 120°F, expected temperature a refrigeration heat recovery unit can pre-heat well water up to.

$\text{Temp}_{\text{cold water}}$ = 52.3°F, average well water temperature

SUMMER COINCIDENT PEAK DEMAND SAVINGS

None

FOSSIL FUEL SAVINGS

$$\Delta Therms = Btu_{\text{Recovered}} * Days * \left(\frac{1}{EF_{\text{gas}}} \right) / 100,000$$

Where:

100,000 =Btu to therms natural gas conversion factor

⁷⁶ The efficacy of a milk plate cooler is sourced from Sanford, Scott (University of Wisconsin–Madison). “Energy Efficiency for Dairy Enterprises.” Presentation to Agricultural and Life Sciences Program staff. December 2014. It was assumed that there is a 25°F of milk temperature difference for a single pass plate cooler and a 35°F of temperature difference for a double/multi-pass plate cooler. For the purposes of this measure, a straight average of 30°F between the two types was used. A plate cooler reduces the overall load on the refrigeration compressors and the revised ΔT when accounting for a milk pre-cooler is 30°F less.

⁷⁷ Sanford, Scott (University of Wisconsin–Madison). “Well Water Precoolers.” Publication A37843. October 2003

⁷⁸ DeLaval. “Dairy Farm Energy Efficiency.” April 20, 2011. DeLaval estimates the heat recovery potential to be between 20 and 60%. Based on engineering judgement and further corroboration from the Wisconsin Focus on Energy TRM, opted to default to a 55% savings factor.

⁷⁹ The hot water use per day is based on the average hot water requirements per wash cycle multiplied by the number of wash cycles per day. The average amount of hot water used per wash cycle, 47.9 gallons, is sourced from the National Resource Conservation Service for Wash Water Requirements for Milking Systems, a calculator developed by University of Wisconsin, August 2005, Milking Center Waste Volume, v12,05, The number of wash cycles per day account for the hot water rinse cycles that are used to flush and clean the milk lines before and after milking. As sourced from the Regional Technical Forum (RTF) as part of the Northwest Power & Conservation Council, Deemed Measures List; Agricultural: Variable Frequency Drives-Dairy, FY2012, v1.2. Pre- and post-power meter data for five sites were used to establish RTF energy savings and the raw data used to generate load profiles showed, on average, two milkings per day. As there will be one more wash cycle than milking, the default average wash cycles per day is three.

EF_{gas} = Energy factor for a standard natural gas water heater
= 59%

Other variables remain consistent with 'Electric Energy Savings' calculation method.

WATER AND OTHER NON-ENERGY IMPACT DESCRIPTIONS AND CALCULATION

N/A

DEEMED O&M COST ADJUSTMENT CALCULATION

N/A

MEASURE CODE: CI-AGE-DRHR-V02-240101

REVIEW DEADLINE: 1/1/2029

4.1.11 Commercial LED Grow Lights

DESCRIPTION

LED lamp technology offers reduced energy and maintenance costs when compared with conventional light sources. LED technology has a significantly longer useful life lasting 30,000 hours or more and significantly reduces maintenance costs. The savings and costs for this measure are evaluated with the replacement of HID grow lights with LED fixtures. LED lamps offer a more robust lighting source, longer lifetime, and greater electrical efficiency than conventional supplemental grow lights.

This measure is designed for other interior horticultural applications that use artificial light stimulation in an indoor conditioned space.

This measure was developed to be applicable to the following program types: TOS, NC. If applied to other program types, the measure savings should be verified.

DEFINITION OF EFFICIENT EQUIPMENT

LED fixtures must have a reduced wattage, be listed on the Design Lights Consortium (DLC) qualified products list,⁸⁰ be UL Listed, have a power factor (PF) ≥ 0.90 , a photosynthetic photon efficacy (PPE) of no less than 2.3 micromoles per joule, a minimum rated lifetime of 50,000 hours, and a minimum warranty of 5 years for the fixture and/or 3 years for the lamp. If DLC PPE requirements for LED grow lighting exceeds the current requirements, the new PPE will become the efficient equipment standard.

DEFINITION OF BASELINE EQUIPMENT

The baseline equipment is the industry established grow light based on the horticultural application, as detailed in the table below. HID fixtures are assumed for flowering and vegetative crops. T5 high-output fixtures are assumed for seedling and microgreen crops.

⁸⁰ Design Light Consortium – Horticultural Lighting, Testing and Reporting Requirements for LED-Based Horticultural Lighting, version 3.0, effective March 31, 2023. To date, all horticultural lamps certified by the DLC specification are LEDs.

Crop Type	Baseline Technology Type	Baseline PPE ($\mu\text{mol}/\text{J}$) ⁸¹	Baseline Fixture Wattage ⁸²
Flowering Crops (Tomatoes and Peppers)	High Pressure Sodium	1.7	1,100 W
Vegetative Growth	Metal Halide	1.25 ⁸³	640 W
Microgreens ⁸⁴	T5 HO Fixture	1.0 ⁸⁵	358 W
Propagation ⁸⁶	T5 HO Fixture	1.0 ⁸⁷	234 W
Medical Cannabis – Flowering Stage	High Pressure Sodium	1.7	1,100 W
Medical Cannabis – Vegetative Stage	Metal Halide	1.25 ⁸⁸	640 W
Medical Cannabis – Cloning, Seeding, and Propagation	T5 HO Fixture	1.0 ⁸⁹	234W
Recreational Cannabis – Flowering Stage	HID/LED/Other	2.2 ⁹⁰	850 W ⁹¹
Recreational Cannabis – Vegetative Stage	HID/LED/Other	2.2 ⁹⁰	640 W
Recreational Cannabis – Cloning, Seeding, and Propagation	T5/LED/Other	2.2 ⁹⁰	234 W

Recreational cannabis cultivation facilities have a separate equipment definition due to Illinois legislation.⁹² See cannabis cultivation code from “Cannabis Regulation and Tax Act,” Illinois HB 1438:

“The Lighting Power Densities (LPD) for cultivation space commits to not exceed an average of 36 watts per gross square foot of active and growing space canopy, or all installed lighting technology shall meet a photosynthetic photon efficacy (PPE) of no less than 2.2 micromoles per joule fixture and shall be featured on the Design Lights Consortium (DLC) Horticultural Specification Qualified Products List (QPL).”

For new construction applications, for non-recreational cannabis facilities, baseline reverts to IECC 2021 which stipulates the following for lighting for plant growth and maintenance:

“Not less than 95 percent of the permanently installed luminaires used for plant growth and maintenance shall have a photon efficiency of not less than 1.6 $\mu\text{mol}/\text{J}$ as defined in accordance with ANSI/ASABE S640.”

⁸³ Jacob A. Nelson, Bruce Bugbee, “Economic Analysis of Greenhouse Lighting: Light Emitting Diodes vs. High Intensity Discharge Fixtures.” Utah State University. Accessed 5/6/2020.

⁸⁴ Microgreens T5 fixture is based on a 6-lamp high output fixture, based on program experience.

⁸⁵ D.S. de Villiers, L.D. Albright, and R. Tuck, “Next Generation, Energy Efficient, Uniform Supplemental Lighting for Closed-System Plant Production.” International Society for Horticultural Science. Accessed 4/8/2022.

⁸⁶ Propagation T5 fixture is based on a 4-lamp high output fixture, based on program experience.

⁸⁷ D.S. de Villiers, L.D. Albright, and R. Tuck, “Next Generation, Energy Efficient, Uniform Supplemental Lighting for Closed-System Plant Production.” International Society for Horticultural Science. Accessed 4/8/2022.

⁸⁸ Jacob A. Nelson, Bruce Bugbee, “Economic Analysis of Greenhouse Lighting: Light Emitting Diodes vs. High Intensity Discharge Fixtures.” Utah State University. Accessed 5/6/2020.

⁸⁹ D.S. de Villiers, L.D. Albright, and R. Tuck, “Next Generation, Energy Efficient, Uniform Supplemental Lighting for Closed-System Plant Production.” International Society for Horticultural Science. Accessed 4/8/2022.

⁹⁰ Recreational cannabis baseline PPE requirement is either 36 W/sqft or 2.2 $\mu\text{mol}/\text{J}$ and DLC listed. Per HB 1438.

⁹¹ Recreational cannabis baseline wattage was back calculated using the medical cannabis – flowering stage wattage of 1,100 W and adjusted by the IL HB 1438 minimum fixture efficiency of 2.2 $\mu\text{mol}/\text{J}$ compared to the typical baseline of 1.7 $\mu\text{mol}/\text{J}$.

⁹² Illinois legislation Public Act 101-0027 the Cannabis Regulation and Tax Act, Article 20: Adult Use Cultivation Centers, (Section 20-15 (a) (23) a commitment to a technology standard for resource efficiency of the cultivation center facility (B) Lighting)

DEEMED LIFETIME OF EFFICIENT EQUIPMENT

The expected measure life is 9.5 years (average rated life of 50,000 hours).⁹³

DEEMED MEASURE COST

LED Fixture Costs:⁹⁴

≤ 250 Watts = \$ 325.87 per fixture

> 250 Watts = \$ 535.04 per fixture

LOADSHAPE

Loadshape C65 – Non-Residential Indoor Agriculture Vegetative Room

Loadshape C66 – Non-Residential Indoor Agriculture Flowering Room

COINCIDENCE FACTOR

Summer coincidence factor for vegetative and flowering rooms = 0.95

Algorithm

CALCULATION OF ENERGY SAVINGS

ELECTRIC ENERGY SAVINGS

PPF Equivalence Method:

$$\Delta kWh = \left[\left(\frac{PPF_{Total,i}}{PPE_{BL,i} \times 1000} \right) - kW_{ee,i} \right] \times Hours \times WHF_e$$

$$PPF_{Total,i} = PPF_{Fixture,i} \times Qty_i$$

Where:

- PPF_{Total,i} = Total Photosynthetically-active Photon Flux output of the installed efficient fixtures for a specific growth phase, i in units of μmol/s. Equal to the number of fixtures installed multiplied by the PPF output per fixture.
- PPE_{BL,i} = Photosynthetically-active Photon Flux Efficiency of the assumed baseline fixture for a specific growth phase, i in units of μmol/J. Can be found in the table above.
- PPF_{Fixture,i} = The Photosynthetically-active Photon Flux output of an individual fixture installed for a specific growth phase, i in units of μmol/s.⁹⁵
- Qty_i = The installed quantity of efficient fixtures.
- i = An indicator used to separate growth phases of products or different plants. “i” can be used to separate “Flowering” and “Vegetative”, or different crop types, such as “Flowering Crops (tomatoes and peppers)” and “Microgreens”.

⁹³ Based on 50,000 hours lifetime and 5,250 hours per year of use (average hours of use per year using flowering and vegetative rooms).

⁹⁴ Focus on Energy Evaluation Business Programs: Measure Life Study Final Report: August 25, 2009

⁹⁵ Individual fixture PPF can be sourced directly from the DLC horticulture qualified products list, Design Light Consortium – Horticultural Lighting, Testing and Reporting Requirements for LED-Based Horticultural Lighting, version 3.0, effective March 31, 2023.

- 1000 = Watts to kilowatts conversion factor
- $kW_{ee,i}$ = Total power of the installed fixtures for a specific growth phase, i.
- Hours = Annual operating hours. See table below for typical hours of operation breakdown by crop type.

Crop Types	Hours of Operation per Day ⁹⁶	Annual Hours of Operation ⁹⁷
Flowering Crops (Tomatoes/Peppers)	12	4,200
Vegetative/Propagation Growth	18	6,300
Microgreens	18	6,300
Medical Cannabis – Flower Stage	12	4,200
Recreational Cannabis – Flowering Stage	12	4,200

- WHFe = 1.21⁹⁸ if cooling or unknown or 1.00 if none; waste heat factor for energy to account for cooling savings from efficient lighting in cooled buildings.

For example, a recreational cannabis growth facility is installing 100 efficient LED fixtures in their flowering spaces. Using the manufacturer and model number, the DLC Qualified Products List for horticulture lighting lists these fixtures as consuming 529W and having a Photosynthetic Photon Efficiency (PPE) of 3.3 $\mu\text{mol}/\text{J}$ and producing 1,722 $\mu\text{mol}/\text{s}$. One hundred (100) fixtures at 529W each is a total lighting power of 52.9 kW. The baseline PPE is 2.2 $\mu\text{mol}/\text{J}$, as dictated by IL HB 1438. The total flux output and annual energy savings calculations are shown below.

$$PPF_{Total,i} = (1,722 \mu\text{mol}/\text{s}) \times 100 \text{ fixtures} = 172,200 \mu\text{mol}/\text{s}$$

$$\Delta kWh = \left[\left(\frac{172,200 \frac{\mu\text{mol}}{\text{s}}}{2.2 \frac{\mu\text{mol}}{\text{J}} \times 1000} \right) - (52.9 \text{ kW}) \right] \times 4,200 \text{ hours} \times 1.21$$

$$= 128,944 \text{ kWh}$$

SUMMER COINCIDENT PEAK DEMAND SAVINGS

$$\Delta kW = \left[\left(\frac{PPF_{Total,i}}{PPE_{BL,i} \times 1000} \right) - kW_{ee,i} \right] \times CF \times WHF_d$$

Where:

- WHF_d = 1.22 if cooling or 1.00 if none; waste heat factor for demand to account for cooling savings from efficient lighting in cooled buildings.
- CF = 0.95 for vegetative crops and flowering crops

⁹⁶ Sole-Source Lighting of Plants. Technically Speaking by Erik Runkle. Michigan State University Extension. September 2017. Accessed: 7/29/2019.

⁹⁷ Annual hours of operation were found by multiplying hours per day by 350 operating days per year. Assuming 5 crop cycles with 3 days of downtime between each cycle

⁹⁸ Waste heat factor for cooling savings calculation can be found in the Indoor Agriculture Loadshapes excel file.

For example, a recreational cannabis growth facility is installing 100 efficient LED fixtures in their flowering spaces. Using the manufacturer and model number, the DLC Qualified Products List for horticulture lighting lists these fixtures as consuming 529W and having a Photosynthetic Photon Efficiency (PPE) of 3.3 $\mu\text{mol}/\text{J}$ and producing 1,722 $\mu\text{mol}/\text{s}$. One hundred (100) fixtures at 529W each is a total lighting power of 52.9 kW. The baseline PPE is 2.2 $\mu\text{mol}/\text{J}$, as dictated by IL HB 1438. The total flux output and peak demand savings calculations are shown below.

$$PPF_{Total,i} = (1,722 \mu\text{mol}/\text{s}) \times 100 \text{ fixtures} = 172,200 \mu\text{mol}/\text{s}$$

$$\Delta kWh = \left[\left(\frac{172,200 \frac{\mu\text{mol}}{\text{s}}}{2.2 \frac{\mu\text{mol}}{\text{J}} \times 1000} \right) - (52.9 \text{ kW}) \right] \times 0.95 \times 1.22$$

$$= 29.41 \text{ kW}$$

FOSSIL FUEL SAVINGS

N/A

WATER AND OTHER NON-ENERGY IMPACT DESCRIPTIONS AND CALCULATION

N/A

DEEMED O&M COST ADJUSTMENT CALCULATION

Any costs associated with moving the LED lighting fixture to different heights throughout the different growing phases should also be included as an O&M consideration.

MEASURE CODE: CI-AGE-GROW-V07-250101

REVIEW DEADLINE: 1/1/2026

4.1.12 Swine Heat Pads

DESCRIPTION

This measure applies to the large Commercial and Industrial sector, specifically for the agriculture industry. Swine farmers will typically keep their newborn piglets alongside their mothers (sows) for up to three to four weeks until they gain sufficient weight and can be moved to a nursery barn. During this farrowing stage, the piglets must be kept at temperatures ranging from 32 to 35°C (90 to 95°F). A sow and her piglets are kept in private farrowing crates, where the sow is kept in a separate and railed cage. This allows the piglets to still suckle from their mother and keeps the sow from crushing her piglets. These farrowing crates can be arranged in single or double systems. Typically, farmers will utilize a heat lamp as the primary heating source for these piglets, which can range from 125 W to 250 W and have an average measure life of 5,000 hours. More energy efficient technology has emerged in the form of heated mats. These mats require significantly less energy than a traditional heat lamp and have no known negative impacts on piglet health. Heating mats come in two options, single (typically rated at ≤100W) or double (typically rated at ≤200W) mats. Single mats serve one litter, and double mats serve two litters.

DEFINITION OF EFFICIENT EQUIPMENT

The use of heat mats in swine farrowing will result in electrical savings for the customer. Research has also shown that newborn piglets do not prefer mat heating over lamp heating, but as they grow, they tend to prefer mat heating. Applied research in large industrial settings found no significant differences between lamp and mat heating on the behavior and well-being of piglets. Therefore, the only difference to note between the two methods is the energy saved in using heating mats.

DEFINITION OF BASELINE EQUIPMENT

The baseline measure for swine farrowing heating is heat lamps, typically ranging from 125 to 250 Watts. Most studies conducted on swine farrowing heat lamps have used 125 watt or 175 watt lamps per litter.^{99,100}

DEEMED LIFETIME OF EFFICIENT EQUIPMENT

The measure life of a farrowing heat mat is 5 years.¹⁰¹

DEEMED MEASURE COST

Heat mat prices will vary somewhat with size but a typical single mat costs \$155 and double mat costs \$280.¹⁰² Additional costs can be incurred if a thermostat controller is included, these start at \$240 but vary widely depending on controller complexity.

LOADSHAPE

Loadshape C04 - Non-Residential Electric Heating

COINCIDENCE FACTOR

The coincidence factor is assumed to be 0.018.¹⁰³

Algorithm

⁹⁹Zhang, Q. and H. Xin, "Responses of Piglets to Creep heat Type and Location in Farrowing Crate," Applied Engineering in Agriculture (2001): Vol. 17(4) 515-519

¹⁰⁰ "Research at Puratone Confirms Effectiveness and Extensive Energy Savings of Heat Pads," Manitoba Hydro Power Smart

¹⁰¹ Professional judgement based on Iowa Energy Efficiency Statewide Technical Reference Manual 2018 Volume 3: Nonresidential Measures, Agriculture Equipment: 3.1.9 Heat Mat, Posted July 12th, 2017

¹⁰² Hog Slat. (2023). Heat Pad. Online pricing catalogue for agriculture and livestock equipment.

¹⁰³ Coincidence factor is taken from the IL TRM loadshape C04 – Non-residential Electric Loadshape.

CALCULATION OF ENERGY SAVINGS

ELECTRIC ENERGY SAVINGS

$$kWh_{saved} = kWh_{base} - kWh_{EE} - kWh_{controller}$$

$$kWh_{base} = \frac{Crates_{total} \times Hours \times Fixture_{crate} \times Lamp_{fixture} \times Wattage_{lamp}}{1000 \frac{Watts}{kW}}$$

$$kWh_{EE} = \frac{Hours \times (Mats_{single} \times Wattage_{single} + Mats_{double} \times Wattage_{double})}{1000 \frac{Watts}{kW}}$$

$$kWh_{controller} = \frac{Hours \times Rooms \times (MSU_{room} \times MSU_{wattage})}{1000 \frac{Watts}{kW}}$$

Where:

$$Crates_{total} = (Crates_{single-row} + Crates_{double-row}) \times Rows \times Rooms$$

$$Mats_{single} = Crates_{single-row} \times Rows \times Rooms$$

$$Mats_{double} = Crates_{double-row} \times Rows \times Rooms$$

- Crates_{total} = Number of Farrowing Crates
- Crates_{single-row} = Number of single crates in a row
- Crates_{double-row} = Number of double crates in a row
- Rows = Number of rows in a room
- Rooms = Number of rooms in a farrowing barn
- Mats_{single} = Number of single mats
- Mats_{double} = Number of double mats
- Wattage_{single} = Default 90W with no MSU, 61W with MSU*; Wattage of a single heat mat
- Wattage_{double} = Default 180W with no MSU, 122W with MSU*; Wattage of a double heat mat
- Hours = Default 5,105 hours;¹⁰⁴ Annual hours of operation
- Fixture_{crate} = Number of heat lamp fixtures per farrowing crate
- Lamp_{fixture} = Number of heat lamps per fixture
- Wattage_{lamp} = Default 125W or 175W; Heat lamp wattage
- MSU_{room} = Default 1; Number of master sensor units (MSU) per room
- MSU_{wattage} = Default 75W; Wattage of master sensor unit

¹⁰⁴ While heat mat hours do vary from heat lamps slightly, the savings assumptions match heat lamp hours for consistency. Calculation method from Iowa State University farm manager (Ben Drescher): "At minimum I'd say they are on 24-7 from Oct-March and March-May, and 12 hours a day June-September 8 hours a day. You'd also take off for power washing etc. so if you had a 24 day turn in a farrowing room you'd run them for 21 days and turn the room subtract 3 days from x 15 turns a year - resulting in 5120 hours." Cadmus did not round data and estimated 5,105 hours. Email sent 10/23/15. "FW: Heat lamp bulbs". Itron benchmarked the HOU with their own analysis which resulted in 5,109 hours: 30.42 days/month; 3 months (summer) run 33% of time; 6 months run 50% of time; 3 months (winter) run full time.

DEFAULT SAVINGS FOR SINGLE UNIT REPLACEMENT

Replacement Type	Baseline Heat Lamp	Annual kWh Savings
Single Mat replacing one Heat Lamp w/o MSU	125W	178.7
Single Mat replacing one Heat Lamp w/ MSU		326.7
Double Mat replacing two Heat Lamps w/o MSU		357.4
Double Mat replacing two Heat Lamps w/ MSU		653.4
Single Mat replacing one Heat Lamp w/o MSU	175W	433.9
Single Mat replacing one Heat Lamp w/ MSU		582.0
Double Mat replacing two Heat Lamps w/o MSU		867.9
Double Mat replacing two Heat Lamps w/ MSU		1163.9

SUMMER COINCIDENT PEAK DEMAND SAVINGS

$$kW_{\text{Saved}} = (kWh_{\text{Saved}} / \text{Hours}) \times CF$$

Where:

kWh_{Saved} = kWh savings, see above equation and table.

Hours = Operating hours, 5,105.

CF = Coincidence Factor, 0.018.¹⁰⁵

DEFAULT SAVINGS FOR SINGLE UNIT REPLACEMENT

Replacement Type	Baseline Heat Lamp	Peak kW Savings
Single Mat replacing one Heat Lamp w/o MSU	125W	0.0006
Single Mat replacing one Heat Lamp w/ MSU		0.0012
Double Mat replacing two Heat Lamps w/o MSU		0.0013
Double Mat replacing two Heat Lamps w/ MSU		0.0023
Single Mat replacing one Heat Lamp w/o MSU	175W	0.0015
Single Mat replacing one Heat Lamp w/ MSU		0.0021
Double Mat replacing two Heat Lamps w/o MSU		0.0027

¹⁰⁵ Coincidence factor is taken from the IL TRM loadshape C04 – Non-residential Electric Loadshape.

Replacement Type	Baseline Heat Lamp	Peak kW Savings
Double Mat replacing two Heat Lamps w/ MSU		0.0041

FOSSIL FUEL SAVINGS

N/A

WATER AND OTHER NON-ENERGY IMPACT DESCRIPTIONS AND CALCULATION

N/A

DEEMED O&M COST ADJUSTMENT CALCULATION

Approximately 1% of mats are likely to be damaged by swine each year and require full replacement.

Additionally, depending on the flooring, some mats may become loose on steel slated floors. This can be prevented by buying mats that have a channel or groove where it sits in the partition. Another option is to buy tie down clips that cost approximately \$24 per double mat.¹⁰⁶

The NPV for replacement heat lamps and annual levelized replacement costs using the societal real discount rate of 0.42% are presented below. The O&M cost adjustments are based on a 1-year measure life for heat lamps and a 5-year analysis period for heat pads. The measure life assumptions indicate an annual lamp replacement cost for the baseline equipment. The heat lamp replacement cost is assumed to be \$5.50.¹⁰⁷

Replacement Type	NPV of Replacement Costs for Period	Levelized Annual Replacement Cost Savings
Single Mat replacing one Heat Lamp	\$20.58	\$4.94
Double Mat replacing two Heat Lamps	\$41.16	\$8.98

MEASURE CODE: CI-AGE-HPAD-V02-240101

REVIEW DEADLINE: 1/1/2029

¹⁰⁶ Franklin Energy field experience

¹⁰⁷ The cost of a replacement heat lamp bulb is sourced from an average of available products via online pricing for agriculture equipment and heat lamps. For more information on the cost of a heat lamp and the derivation of O&M cost savings, please see: "Swine Heat Pads_OM.xlsx".

4.1.13 Irrigation Pump VFD

DESCRIPTION

This measure applies to variable speed drives (VSD) installed on irrigation pump motors for the agriculture industry. This characterization does not apply to positive displacement pumps. The VFD will modulate the speed of the motor when it does not need to run at full load. Since the power of the motor is proportional to the cube of the speed for these types of applications, significant energy savings will result.

This measure was developed to be applicable to the following program types: TOS, RF. If applied to other program types, the measure savings should be verified.

DEFINITION OF EFFICIENT EQUIPMENT

The VFD is applied to a motor that does not yet have one. The irrigation system must have a variable load, and installation is to include the necessary controls as determined by a qualified engineer. Savings are based on application of VFDs to a range of baseline load conditions.

DEFINITION OF BASELINE EQUIPMENT

The time of sale baseline is a new motor installed without a VFD or other methods of control. The retrofit baseline is an existing motor operating as is. Retrofit baselines may or may not include guide vanes, throttling valves, or other methods of control. This information shall be collected from the customer.

Installations of new equipment with VFDs that are required by IECC 2018 as adopted by the State of Illinois are not eligible to claim savings¹⁰⁸.

DEEMED LIFETIME OF EFFICIENT EQUIPMENT

The expected measure life is 15 years.¹⁰⁹

DEEMED MEASURE COST

Customer provided costs will be used when available. Default measure costs¹¹⁰ are noted below for up to 75 hp motors. Custom costs must be gathered from the customer for motor sizes not listed below.

HP	Cost
1-9 HP	\$1,874
10-19 HP	\$2,967
20-29 HP	\$4,060
30-39 HP	\$5,154
40-49 HP	\$6,247
50-59 HP	\$7,340
60-69 HP	\$8,433
70-75 HP	\$9,526

LOADSHAPE

Loadshape C59 – Agriculture and Water Pumping

COINCIDENCE FACTOR

The installation of a VFD on an irrigation pump should not cause any energy reduction during peak runtimes.

¹⁰⁸ Utah State University Extension. *Variable Frequency Drives for Irrigation Pumps* Variable. Frequency Drives for Irrigation Pumps. Published March 2020

¹⁰⁹ DEER 2014.

¹¹⁰ Average from IPL and MidAmerican VFD reported costs from rebate forms. IPL & MidA VFD Costs.xls

Algorithm

CALCULATION OF ENERGY SAVINGS

ELECTRIC ENERGY SAVINGS

$$\Delta kWh = kWh_{Base} - kWh_{VFD}$$

$$kWh_{Base} = \sum_1^{\eta} HP_{\eta} * 0.746 \frac{kW}{HP} * Hours_{year} * \%Hours_{\eta}$$

$$kWh_{VFD} = \sum_1^{\eta} HP_{VFD,\eta} * 0.746 \frac{kW}{HP} * Hours_{year} * \%Hours_{\eta}$$

$$HP_{\eta} = \frac{Flow_{\eta} * Head_{\eta}}{3960 * (Eff_{pump} * Eff_{motor})}$$

$$HP_{VFD,\eta} = \frac{Flow_{\eta} * Head_{VFD,\eta}}{3960 * (Eff_{pump} * Eff_{VFD} * Eff_{motor})}$$

$$Hours_{year} = \frac{Acres * Irrigation}{12 \frac{in}{ft} * 60 \frac{min}{hr} * GPM_{system} / \left(7.481 \frac{gal}{ft^3} * 43,560 \frac{ft^2}{acre} \right)}$$

Where:

- kWh_{Base} = Annual energy required for the baseline pump condition
- kWh_{VFD} = Annual energy required with a VFD pump installed
- HP_η = Baseline horsepower required for a given flow rate
- HP_{VFD,η} = Horsepower required for a given flow rate with the VFD installed
- Hours_{year} = Annual Hours of irrigation
- %Hours_η = Percent of time irrigation pump will be operating at a given flow rate
- η = Number of data points needed or collected
- Flow_η = Flow rate at a given data point in gallons per minute, use actual values
- Head_η = Pressure head at a given data point in feet, use actual values
- Head_{VFD,η} = Pressure head at a given data point in feet with a VFD
- Eff_{pump} = Percent efficiency of the pump, taken from manufacturers pump curve
- Eff_{motor} = Percent efficiency of the pump motor

NEMA Premium Efficiency Motors Default Efficiencies¹¹¹

¹¹¹ Douglass, J. (2005). Induction Motor Efficiency Standards. Washington State University and the Northwest Energy Efficiency Alliance, Extension Energy Program, Olympia, WA, October 2005.

Size HP	Open Drip Proof (ODP)			Totally Enclosed Fan-Cooled (TEFC)		
	# of Poles			# of Poles		
	6	4	2	6	4	2
	Speed (RPM)			Speed (RPM)		
	1200	1800 Default	3600	1200	1800	3600
1	0.825	0.855	0.770	0.825	0.855	0.770
1.5	0.865	0.865	0.840	0.875	0.865	0.840
2	0.875	0.865	0.855	0.885	0.865	0.855
3	0.885	0.895	0.855	0.895	0.895	0.865
5	0.895	0.895	0.865	0.895	0.895	0.885
7.5	0.902	0.910	0.885	0.910	0.917	0.895
10	0.917	0.917	0.895	0.910	0.917	0.902
15	0.917	0.930	0.902	0.917	0.924	0.910
20	0.924	0.930	0.910	0.917	0.930	0.910
25	0.930	0.936	0.917	0.930	0.936	0.917
30	0.936	0.941	0.917	0.930	0.936	0.917
40	0.941	0.941	0.924	0.941	0.941	0.924
50	0.941	0.945	0.930	0.941	0.945	0.930
60	0.945	0.950	0.936	0.945	0.950	0.936
75	0.945	0.950	0.936	0.945	0.954	0.936
100	0.950	0.954	0.936	0.950	0.954	0.941
125	0.950	0.954	0.941	0.950	0.954	0.950
150	0.954	0.958	0.941	0.958	0.958	0.950
200	0.954	0.958	0.950	0.958	0.962	0.954
250	0.954	0.958	0.950	0.958	0.962	0.958
300	0.954	0.958	0.954	0.958	0.962	0.958
350	0.954	0.958	0.954	0.958	0.962	0.958
400	0.958	0.958	0.958	0.958	0.962	0.958
450	0.962	0.962	0.958	0.958	0.962	0.958
500	0.962	0.962	0.958	0.958	0.962	0.958

- Eff_{VFD} = Percent efficiency of the VFD
= 97%¹¹²
- Acres = Size of the field that is being irrigated in acres
- Irrigation = Gross irrigation required in inches per year
- GPM_{System} = Required system flow rate in gallons per minute

¹¹² Estimated typical VFD efficiency, as sourced from; “Chapter 18: Variable Frequency Drive Evaluation Protocol”, The Uniform Methods Project: Methods for Determining Energy Efficiency Savings for Specific Measures, NREL, December 2014 (pg. 2)

For example, using the default assumptions on the installation of a VFD controlled by a pressure sensor is installed on a 25 hp irrigation pump using a central pivot to water corn for grain.

$$\begin{aligned}
 \text{Hours}_{\text{Year}} &= (80 * 14.5) / ((12 * 60 * 300) / (7.481 * 43,560)) \\
 &= 1,750 \text{ hours} \\
 \text{HP}_n &= (300 * 120) / (3,960 * (0.615 * 0.936)) \\
 &= 15.79 \\
 \text{kWh}_{\text{Base}} &= 15.79 * 0.746 * 1750 * 0.5 \\
 &= 10,306.9 \\
 \text{HP}_{\text{VFDn}} &= (300 * 90) / (3,960 * (0.615 * 0.97 * 0.936)) \\
 &= 12.21 \\
 \text{kWh}_{\text{VFD}} &= 12.21 * 0.746 * 1750 * 0.5 \\
 &= 7,970 \\
 \Delta\text{kWh} &= 10,306.9 - 7,970 \\
 &= 2,337 \text{ kWh}
 \end{aligned}$$

SUMMER COINCIDENT PEAK DEMAND SAVINGS

There are no expected peak demand impacts for this measure.

FOSSIL FUEL SAVINGS

There are no expected fossil fuel impacts for this measure.

WATER AND OTHER NON-ENERGY IMPACT DESCRIPTIONS AND CALCULATION

While there may be water savings from the installation of a VFD on an irrigation pump, they are not being included at this time. Any water savings calculations should be handled in a custom manner.

DEEMED O&M COST ADJUSTMENT CALCULATION

N/A

MEASURE CODE: CI-AGE-PUMP-V02-250101

REVIEW DEADLINE: 1/1/2027

4.1.14 High Efficiency Grain Dryer

DESCRIPTION

This measure characterizes the energy savings from the replacement of an existing inefficient grain dryer with a new efficient grain dryer (Early Replacement incentive program). Alternatively, this measure is for the purchase of a new high efficiency grain dryer instead of a new standard efficiency grain dryer for an existing facility (Time of Sale program) or a new facility (New Construction incentive program). Energy savings are achieved by drying grain more efficiently through: improved dryer air flow design, improved dryer controls, warm air heat recovery, and burner efficiency improvements. Efficient dryers also have the benefits of increased throughput capacity and reduced annual hours of operation.

This measure was developed to be applicable to the following program types: TOS, EREP, and NC. If applied to other program types, the measure savings should be verified.

DEFINITION OF EFFICIENT EQUIPMENT

The efficient equipment is assumed to be a new, high efficiency grain dryer. Bushels per hour must be provided by the manufacturer, as rated at 5% moisture removal rate per bushel processed.

DEFINITION OF BASELINE EQUIPMENT

The baseline for this measure is a standard efficiency grain dryer currently on the market. Bushels per hour must be provided by the manufacturer, as rated at 5% moisture removal rate per bushel processed.

DEEMED LIFETIME OF EFFICIENT EQUIPMENT

The measure life for the energy-efficient grain dryer is deemed to be 20 years¹¹³.

DEEMED MEASURE COST

If known, the actual material and labor cost of installation should be used. If unknown, the cost of the measure is assumed to be the values summarized in the table below:

Tier (bushels per hour)	Tier (annual bushels)	High-Efficiency Dryer Total Installation Cost (for Early Replacement only)	Average Incremental Cost of of High-Efficiency Dryer vs Standard Dryer	Average Incremental Cost of Variable Speed Drive added to Cost of High-Efficiency Dryer
<500	< 170,000	\$83,000 (Based on baseline price of \$50,000 + (\$50/Bu/hr * 250 Rated Bu/hr) + Incremental Cost of High Efficiency)	\$20,000	\$4,000 (Based on baseline price of \$2,500 + 0.046kW/Bu/hr * 250 Rated Bu/hr) *\$100/kW)
≥ 500 and < 1,000	≥ 170,000 and < 330,000	\$118,000 (Based on 750 Rated Bu/hr)	\$30,000	\$6,000 (Based on 750 Rated Bu/hr)
≥ 1,000 and < 2,000	≥ 330,000 and < 670,000	\$165,000 (Based on 1,500 Rated Bu/hr)	\$40,000	\$9,000 (Based on 1,500 Rated Bu/hr)

¹¹³ Iowa State University Ag Extension, “Computing a Grain Storage Rental Rate”, October 2013. The useful life of grain storage bins was estimated to be between 15 and 25 years and the drying equipment useful life was estimated to be between 10 and 12 years. Combined with engineering judgement, the estimated measure life for a high efficiency grain dryer is estimated to be 20 years, which is corroborated by the Wisconsin Focus on Energy 2021 Technical Reference Manual, Cadmus, Publich Service Commission of Wisconsin – Energy Efficient Grain Dryer.

Tier (bushels per hour)	Tier (annual bushels)	High-Efficiency Dryer Total Installation Cost (for Early Replacement only)	Average Incremental Cost of High-Efficiency Dryer vs Standard Dryer	Average Incremental Cost of Variable Speed Drive added to Cost of High-Efficiency Dryer
≥ 2,000 and < 3,500	≥ 670,000 and < 1,200,000	\$258,000 (Based on 2,750 Rated Bu/hr)	\$70,000	\$15,000 (Based on 2,750 Rated Bu/hr)
≥ 3,500 and ≤ 5,000	≥ 1,200,000 and ≤ 1,700,000	\$363,000 (Based on 4,250 Rated Bu/hr)	\$100,000	\$22,000 (Based on 4,250 Rated Bu/hr)
> 5,000	> 1,700,000	\$488,000 (Based on 6,250 Rated Bu/hr)	\$125,000	\$31,000 (Based on 6,250 Rated Bu/hr)

Early Replacement: The full installation cost is provided in the table above. The assumed deferred cost (after 6.5 years [one third of useful life]) of replacing existing equipment with a new baseline unit is assumed to be the installation cost discounted to present value using the nominal discount rate.

LOADSHAPE

Loadshape NRE11 – Non-Residential Agriculture

COINCIDENCE FACTOR

There are no summer peak savings associated with this measure as it is assumed grain dryers do no operate during peak summer months.

Algorithm

CALCULATION OF ENERGY SAVINGS

ELECTRIC ENERGY SAVINGS

If grain dryer is heated exclusively with electricity:

$$\Delta kWh = \text{Bushels/Hr}_{\text{Capacity}} * \text{Annual_Hr_Use}_{\text{@Rated_Capacity}} * (\text{Moisture_}\%_{\text{In}} - \text{Moisture_}\%_{\text{Out}}) * \text{Grain_Lb_Moisture_}/\text{Bushel} * \text{Btu/Lb}_{\text{Evap}} * (1 / \text{Dryer_Effcy}_{\text{Std}} - 1 / \text{Dryer_Effcy}_{\text{Eff}}) / 3,412 + (\text{Dryer_Fan_Power}_{\text{Standard}} - \text{Dryer_Fan_Power}_{\text{Efficient}}) * \text{Bushels/Hr}_{\text{Capacity}} * \text{Annual_Hr_Use}_{\text{@Rated_Capacity}}$$

Where:

$\text{Bushels/Hr}_{\text{Capacity}}$ = Capacity of Grain Dryer in Bushels/Hr when reducing grain moisture content by 5%

$\text{Annual_Hr_Use}_{\text{@Rated_Capacity}}$ = Average annual hours of use of typical grain dryer
 = Deemed value of 336.3 hr/year¹¹⁴

¹¹⁴ Alliant Energy Custom Rebate project data from 2012-2014; original Alliant table was modified, adding a new column of hours per year use and renaming labels. Annual tier production quantities (bushels/yr) were divided by the maximum nominal tier capacities (bushels/hr @ rated capacity) to obtain Hours per Year @ Rated Capacity. Arithmetic average hours of use was 336.3 per year.

Annual hours of use were calculated based on following table. Deemed value is arithmetic average of Average Use per Year

Savings Tier (Bushels/hr) from Manufacturer	Savings Tier (Bushels/yr)	Average Hours/yr @ Rated Capacity
>= 0 Bu/Hr	170,000	340
>= 500 Bu/Hr	330,000	330
>= 1,000 Bu/Hr	670,000	335
>= 2,000 Bu/Hr	1,200,000	343
>= 3,500 Bu/Hr	1,700,000	340
>= 5,000 Bu/Hr	2,475,000	330

Moisture_%_{In} = 23%¹¹⁵, a deemed value representing average % moisture in grain arriving at grain dryer facility¹¹⁶

Moisture_%_{Out} = 15%¹¹⁷, a deemed value representing average % moisture in grain after being dried at grain dryer facility

Grain_Lb_Moisture_/_Bushel = Lookup value from following table, Lb Moisture per Bushel per 1% of moisture content reduction. ¹¹⁸

¹¹⁵ Wisconsin Focus on Energy project data; 13 recent grain dryer projects in Wisconsin were used as the source of average pre- and post- moisture content (23% and 15%, respectively) and baseline and proposed dryer efficiency.

¹¹⁶ The National Corn Handbook. "Energy Conservation and Alternative Sources for Corn Drying." NCH-14, page 3, Table 4. <http://corn.agronomy.wisc.edu/Management/NCH.aspx>

¹¹⁷ Wisconsin Focus on Energy project data; 13 recent grain dryer projects in Wisconsin were used as the source of average pre- and post- moisture content (23% and 15%, respectively) and baseline and proposed dryer efficiency.

¹¹⁸ "Tables for Weights and Measurement: Crops". Murhpy, William J. Table shown was modified from the original by eliminating some redundant rows for similar crops, and by adding a new column that calculates pounds of moisture evaporated per Standard Bushel per 1% moisture reduction by the dryer.

Grain Type	Weight of "Standard Bushel"	Lb Moisture/Bu/1% Evap
Alfalfa	60.0 Lb/Std Bu	0.60 Lb Evap/Std Bu/Delta%
Barley	48.0 Lb/Std Bu	0.48 Lb Evap/Std Bu/Delta%
Clover	60.0 Lb/Std Bu	0.60 Lb Evap/Std Bu/Delta%
Corn, Shelled (15.5%)	56.0 Lb/Std Bu	0.56 Lb Evap/Std Bu/Delta%
Corn, Ear (15.5%)	68.4 Lb/Std Bu	0.68 Lb Evap/Std Bu/Delta%
Cotton	32.0 Lb/Std Bu	0.32 Lb Evap/Std Bu/Delta%
Cowpeas	60.0 Lb/Std Bu	0.60 Lb Evap/Std Bu/Delta%
Flax	60.0 Lb/Std Bu	0.60 Lb Evap/Std Bu/Delta%
Grass, Exc Timothy	14.0 Lb/Std Bu	0.14 Lb Evap/Std Bu/Delta%
Grass, Timothy	45.0 Lb/Std Bu	0.45 Lb Evap/Std Bu/Delta%
Lespedeza	45.0 Lb/Std Bu	0.45 Lb Evap/Std Bu/Delta%
Millet	80.0 Lb/Std Bu	0.80 Lb Evap/Std Bu/Delta%
Oats	32.0 Lb/Std Bu	0.32 Lb Evap/Std Bu/Delta%
Rape	60.0 Lb/Std Bu	0.60 Lb Evap/Std Bu/Delta%
Tye	56.0 Lb/Std Bu	0.56 Lb Evap/Std Bu/Delta%
Sorghum, Forage	50.0 Lb/Std Bu	0.50 Lb Evap/Std Bu/Delta%
Sorghum, grain (13.0%)	56.0 Lb/Std Bu	0.56 Lb Evap/Std Bu/Delta%
Soybeans	60.0 Lb/Std Bu	0.60 Lb Evap/Std Bu/Delta%
Sudan grass	28.0 Lb/Std Bu	0.28 Lb Evap/Std Bu/Delta%
Sunflower, oil type	28.0 Lb/Std Bu	0.28 Lb Evap/Std Bu/Delta%
Trefoil, Birdsfoot	60.0 Lb/Std Bu	0.60 Lb Evap/Std Bu/Delta%
Vetch	60.0 Lb/Std Bu	0.60 Lb Evap/Std Bu/Delta%
Wheat (13.5%)	60.0 Lb/Std Bu	0.60 Lb Evap/Std Bu/Delta%

Btu/Lb_{Evap} = 990 Btu per Lb of Water Evaporated; an engineering constant

Dryer_Effcy_{Std} = Electric grain dryer efficiency of a standard-efficiency electric bin dryer, expressed as a %, defined as Btu of moisture evaporated in the dryer divided by the heating Btu input into the dryer

=71%¹¹⁹, a deemed value, based on the following table, which represents BTU/Lb evaporated and equivalent Overall Efficiency for the dryers and heating sources used in this TRM:

¹¹⁹ "Reducing Grain Drying Costs". Sanford, Scott., University of Wisconsin Rural Energy Program, 2013. Notes 20-30% savings in bin dryers through the use of stirrers and ambient air low temperature drying. Based on this, 71% is used as a conservative value, but Actual values can be used if available. Accessed August 19, 2020.

Grain Dryer Description	Dryer Efficiency (Dryer_Effcy)		Dryer Fan Power (Dryer_Fan_Power)
	Dryer_Effcy	Btu/lb Water Evaporated (Btu/lb Water)	kW / Bushel
Baseline Gas Grain Dryer w/ Constant Speed Fan Operation	44%	2,241	0.044
Efficient Gas Grain Dryer w/ Constant Speed Fan Operation	61%	1,625	0.044
Efficient Gas Grain Dryer w/ Damper Fan Operation	61%	1,625	0.035
Efficient Gas Grain Dryer w/ Fan VFD	61%	1,625	0.002
Baseline Electric Bin Grain Dryer w/ Constant Speed Fan Operation	71%	1,400	0.44
Efficient Electric Bin Grain Dryer w/ Constant Speed Fan Operation	88%	1,120	0.044
Efficient Electric Bin Grain Dryer w/ Damper Fan Operation	88%	1,120	0.035
Efficient Electric Bin Grain Dryer w/ Fan VFD	88%	1,120	0.002

Dryer_Effcy_{eff} = Actual or a deemed value based upon above table. If unknown assume 88%¹²⁰. See prior footnote for derivation of this value.

3,412 = Conversion factor of kWh to Btu; engineering constant.

Dryer_Fan_Power_{Standard} = 0.044 kW/Bu¹²¹, from above table, a deemed value, based on the following average standard bin dryer operational parameters, and the engineering equation:

$$\text{kW/Bu}_{Std} = \text{CFM/Bu}_{Std} * \text{in.}_{wc}_{Std} / 6,354 / \text{Fan_Efficiency}_{Std} * 0.746 / \text{Motor_Effcy}_{Std}.$$

In the above equation, the following deemed constants are typical for standard-efficiency Grain Dryers:

Where:

CFM/Bu_{Std} = 61 CFM/Bu

in._{wc}_{Std} = 3.0" wc

6,354 = Units conversion from cfm * in. wc. / Fan_Efficiency to BHP

Fan_Efficiency_{Std} = 60%

0.746 = Units conversion from BHP to kW

Motor_Effcy_{Std} = 80%.

$$\begin{aligned} \text{kW/Bu} &= 61 * 3.0 / 6,354 / 60\% * 0.746 / 80\% \\ &= 0.044 \text{ kW/Bu} \end{aligned}$$

¹²⁰ Alliant Energy Custom Rebate project data from 2012-2014; same comments apply as in prior footnote.

¹²¹ The Standard Dryer Fan Power using the fan brakehorsepower equation.

Dryer_Fan_Power_{Efficient} = 0.035 kW/Bu¹²², if fan volume is controlled using outlet damper, or
 = 0.002 kW/Bu, if fan volume is controlled using VFD.

Above values are deemed constants, based on the following average high-efficiency bin dryer operational parameters, and the engineering equation:

$$\text{kW/Bu}_{\text{Eff}} = \text{CFM/Bu}_{\text{Eff}} * \text{in.}_{\text{wcEff}} / 6,354 / \text{Fan_Efficiency}_{\text{Eff}} * 0.746 / \text{Motor_Effcy}_{\text{Eff}} / \text{Drive_Effcy}_{\text{Eff}}$$

In the above equation, the following deemed constants are assumed to apply to high-efficiency Grain Dryers:

Where:

- CFM/Bu_{Eff} = 22
- in._wc_{Eff} = 4.4" if Outlet Damper control; 0.4" if VFD control
- 6,354 = Units conversion from cfm * in. wc. / Fan_Efficiency to BHP
- Fan_Efficiency_{Eff} = 60%
- 0.746 = Units conversion from BHP to kW
- Motor_Effcy_{Eff} = 80%
- Drive_Effcy_{Eff} = 100% if Outlet Damper control; 95% if VFD control.

For high-efficiency dryer with VFD control:

$$\begin{aligned} \text{kW/Bu} &= 22 * 0.4 / 6,354 / 60\% * 0.746 / 80\% / 95\% \\ &= 0.002 \text{ kW/Bu} \end{aligned}$$

For example, using the default assumptions on the installation of a 3,000 bushels/hr electric grain dryer with Outlet Damper used for Alfalfa:

$$\begin{aligned} \Delta \text{kWh} &= (3,000 * 336.3 * (0.23 - 0.15) * 0.60 * 990 * (1/0.71 - 1/0.88)/3,412) + ((0.044 - 0.035) * 3,000 \\ &\quad * 336.3) \\ &= 12,903 \text{ kWh} \end{aligned}$$

SUMMER COINCIDENT PEAK DEMAND SAVINGS

N/A

FOSSIL FUEL SAVINGS

If grain dryer is heated exclusively with natural gas:

$$\begin{aligned} \Delta \text{Therms} &= \text{Bushels/Hr}_{\text{Capacity}} * \text{Annual_Hr_Use}_{\text{@Rated_Capacity}} * (\text{Moisture}_{\% \text{In}} - \text{Moisture}_{\% \text{Out}}) * \\ &\quad \text{Grain_Lb_Moisture_}/_ \text{Bushel} * \text{Btu/Lb}_{\text{Evap}} * (1 / \text{Dryer_Effcy}_{\text{Std}} - 1/ \text{Dryer_Effcy}_{\text{Eff}}) / 100,000 \end{aligned}$$

Where:

100,000 = Conversion factor of Therms to Btu; engineering constant.

All variables are as defined and derived in the preceding electric savings calculations, but using values in the dryer efficiency table above for Baseline or Efficient "Gas or Propane Grain Dryer".

¹²² The same Dryer Fan Power formula as in the above footnote.

Note: When a variable frequency drive (VFD) is incorporated on the drying fan, electrical savings may be claimed by the fan power derivation in the electric savings algorithm for additive electrical savings for a gas heated grain dryer.

For example, using the default assumptions on the installation of a 3,000 bushels/hr gas grain dryer with Outlet Damper used for Alfalfa:

$$\begin{aligned}\Delta\text{Therms} &= 3,000 * 336.3 * (0.23 - 0.15) * 0.60 * 990 * (1/0.44 - 1/0.61)/100,000 \\ &= 303.7 \text{ Therms}\end{aligned}$$

WATER AND OTHER NON-ENERGY IMPACT DESCRIPTIONS AND CALCULATION

N/A

DEEMED O&M COST ADJUSTMENT CALCULATION

N/A

MEASURE CODE: CI-AGE-GDRY-V02-250101

REVIEW DEADLINE: 1/1/2027

4.1.15 Grain Dryer Tune-Up

DESCRIPTION

This measure is for commercial grain dryers for agricultural operations. Tune-ups improve grain drying efficiency by maintaining dryer components that have become clogged, dirty, or uncalibrated. This measure involves cleaning and/or inspecting burners, fans, and screens and cleaning and recalibrating all temperature and moisture sensors, if applicable.

Crops such as grain, soybeans, and corn need to be dried after harvest to prevent rot, mold, and animals from destroying the crop. After harvest, these wet crops are loaded into a grain dryer where they are dried. Grain drying processes vary but consist of warm (or high temperature) air forced through the crop. The air may be heated electrically or by fossil fuels. Once the grain is dried, it is stored in grain bins or silos until transport. At the time of harvest, moisture content inside grain varies between 17% and 40%. After drying, moisture levels are kept between 13% and 14% to improve shelf life. Maintaining peak efficiency of grain dryers through tune-ups is important for equipment efficiency and grain drying performance. Tune-ups save energy by removing impediments to airflow and calibrating sensors so that equipment capacity is maximized and drying time is minimized.

DEFINITION OF EFFICIENT EQUIPMENT

To qualify for this measure, the facility must, as applicable, complete the tune-up requirements by an approved technician as specified below:

- Inspect and clean screens
- Inspect and clean fans
- Clean and calibrate all temperature sensors
- Clean and calibrate all moisture sensors*
- Inspect and adjust grain dryer controls including temperature setpoint, as needed
- Lubricate bearings

Task marks with an asterisk (*) are only required if the existing grain dryer contains this equipment.

DEFINITION OF BASELINE EQUIPMENT

The baseline condition of this measure is a commercial-grade grain dryer that has not been tuned-up within the past 12 months.

DEEMED LIFETIME OF EFFICIENT EQUIPMENT

The life of this measure is 1 year.¹²³

DEEMED MEASURE COST

The cost of this measure is \$500.00, which includes service and labor.¹²⁴

LOADSHAPE

N/A

COINCIDENCE FACTOR

N/A

¹²³ University of Wisconsin-Madison Extension. "Low Cost Energy Conservation: Grain Drying (A3784-10)." Tune-Ups are recommended annually because of the dusty environment components are subject to during the grain drying process. Although farms often defer grain dryer maintenance, the energy savings will not persist over multiple seasons.

¹²⁴ From Wisconsin Focus on Energy 2020 Technical Reference Manual, Grain Dryer Tune-Up (pg. 44). Incremental costs are based on trade ally survey.

Algorithm

CALCULATION OF ENERGY SAVINGS

ELECTRIC ENERGY SAVINGS

$$\Delta kWh = Bushels_{ANNUAL} * kWh \text{ Saved per Bushel}$$

Where:

$Bushels_{ANNUAL}$ = Number of bushels of grain to be dried per year (bushels/yr)
 = Custom

Where:

$$kWh \text{ Saved per Bushel} = \left(GD_{EFF} * Lbs_{H2O \text{ REMOVED}} * \frac{kWh\%}{3,412} \right) * SF$$

Where:

$kWh \text{ Saved per Bushel}$ = Amount of energy saved per bushel of grain dried. Use actual if known. If unknown, default to calculated values in table below based on grain dryer type and efficiency.

GD_{EFF} = Existing grain dryer efficiency (Btu/Lbs_H2O)
 = Custom, or default value in table below based on type of grain dryer

Grain Dryer Type	GD_EFF (Btu/Lbs_H2O) ¹²⁵	kWh% ¹²⁶	kWh Saved per Bushel	Therm Saved per Bushel
Low Temperature Bin Dryer	1,600	100%	0.11723	0
Continuous Mixed Flow Bin Dryer	2,000	2%	0.00293	0.00490
Mixed Flow Dryer	2,000	2%	0.00293	0.00490
High Temperature Batch Bin Dryer	2,400	2%	0.00352	0.00588
Continuous Cross-Flow (Tower) Dryer	2,400	2%	0.00352	0.00588
Cross-Flow Batch Dryer	2,500	2%	0.00366	0.00613

$$Lbs_{H2O \text{ REMOVED}} = Grain_{LBS \text{ MOISTURE}} * (\% \text{ Moisture}_{IN} - \% \text{ Moisture}_{OUT})$$

Where:

$Lbs_{H2O \text{ REMOVED}}$ = Pounds of water removed per bushel
 = Default value in table or Custom calculation as detailed below

¹²⁵ U.S. Department of Agriculture. "Energy Self-Assessment, Step 2: Informational Section." Grain Drying Energy Efficiency and Energy Cost graph. Accessed May 2019. See Grain Dryer Tune Up Supporting Document for referenced graph. And University of Wisconsin–Madison, Extension. Wisconsin Energy Efficiency and Renewable Energy "Improving Energy Efficiency in Grain Drying: Fact Sheet." December 2012. **Error! Hyperlink reference not valid.**

¹²⁶ The National Corn Handbook. "Energy Conservation and Alternative Sources for Corn Drying." NCH-14, page 3, Table 4.

Crop Type	Moisture Removal Assumption	LBS_H2O Removed per Bushels _{annual}
Corn	7% reduction (from 22% initial moisture content (MC) to 15% final MC) ¹²⁷	5.00
Soybean	7% reduction (from 20% initial MC to 13% final MC) ¹²⁸	5.04 ¹²⁹

$Grain_{LBS\ MOISTURE}$ = Lbs of moisture per bushel per 1% of moisture content reduction. Value is specific to grain type and is based on the following table: ¹³⁰

Grain Type	Lb Moisture/Bushel/1% Evaporation
Alfalfa	0.60 Lb Evap/Std Bu/Delta%
Barley	0.48 Lb Evap/Std Bu/Delta%
Clover	0.60 Lb Evap/Std Bu/Delta%
Corn, Shelled (15.5%)	0.56 Lb Evap/Std Bu/Delta%
Corn, Ear (15.5%)	0.68 Lb Evap/Std Bu/Delta%
Cotton	0.32 Lb Evap/Std Bu/Delta%
Cowpeas	0.60 Lb Evap/Std Bu/Delta%
Flax	0.60 Lb Evap/Std Bu/Delta%
Grass, Exc Timothy	0.14 Lb Evap/Std Bu/Delta%
Grass, Timothy	0.45 Lb Evap/Std Bu/Delta%
Lespedeza	0.45 Lb Evap/Std Bu/Delta%
Millet	0.80 Lb Evap/Std Bu/Delta%
Oats	0.32 Lb Evap/Std Bu/Delta%
Rape	0.60 Lb Evap/Std Bu/Delta%
Tye	0.56 Lb Evap/Std Bu/Delta%
Sorghum, Forage	0.50 Lb Evap/Std Bu/Delta%
Sorghum, grain (13.0%)	0.56 Lb Evap/Std Bu/Delta%
Soybeans	0.60 Lb Evap/Std Bu/Delta%
Sudan grass	0.28 Lb Evap/Std Bu/Delta%
Sunflower, oil type	0.28 Lb Evap/Std Bu/Delta%
Trefoil, Birdsfoot	0.60 Lb Evap/Std Bu/Delta%
Vetch	0.60 Lb Evap/Std Bu/Delta%
Wheat (13.5%)	0.60 Lb Evap/Std Bu/Delta%

$\% Moisture_{IN}$ = Average % moisture of grain as it arrives at the grain dryer
 = Actual

¹²⁷ The National Corn Handbook. “Energy Conservation and Alternative Sources for Corn Drying.” NCH-14, page 3, Table 4.

¹²⁸ University of Nebraska-Lincoln, Institute of Agriculture and Natural Resources. “Harvest Soybeans at 13% Moisture”.

¹²⁹ University of Minnesota Extension. “Storing, drying, and handling wet soybeans”. **Error! Hyperlink reference not valid.**

¹³⁰ “Tables for Weights and Measurement: Crops”. Murhpy, William J. Table shown was modified from the original by eliminating some redundant rows for similar crops, and by adding a new column that calculates pounds of moisture evaporated per standard bushel per 1% moisture reduction by the dryer.

- $\% Moisture_{OUT}$ = Average % moisture of grain as it exits the grain dryer after being dried
- = Actual
- $kWh\%$ = Percentage of overall dryer energy consumption that is electricity
- = Default value in table above based on type of grain dryer
- 3,412 = Conversion from Btu to kWh
- SF = Savings factor
- = $5\%^{131}$

For example, for a Mixed Flow Dryer that produces 100,000 bushels of corn per year.

$$\Delta Therms = 100,000 \frac{Bu}{yr} \times \left(2,000 \frac{Btu}{lb H_2O} \times 5.00 \frac{lbs H_2O}{bu} \times \frac{98 \% Therm}{100,000 \frac{Btu}{Therm}} \right) \times 5\%$$

$$\Delta Therms = 490$$

SUMMER COINCIDENT PEAK DEMAND SAVINGS

N/A

FOSSIL FUEL SAVINGS

$$\Delta Therms = Bushels_{ANNUAL} * Therms Saved per Bushel$$

$$Therms Saved per Bushel = \left(GD_{EFF} * Lbs_{H_2O REMOVED} * \frac{Therms\%}{100,000} \right) * SF$$

Where:

Therms Saved per Bushel = Amount of energy saved per bushel of grain dried. Use actual if known. If unknown, default to calculated values in table above based on grain dryer type and efficiency.

- Therms% = Percentage of overall dryer energy consumption that is natural gas
- = $(1 - kWh\%)$
- 100,000 = Conversion factor
- $Lbs_{H_2O REMOVED}$ = $Grain_{LBS MOISTURE} * (\%Moisture_{IN} - \%Moisture_{OUT})$

WATER AND OTHER NON-ENERGY IMPACT DESCRIPTIONS AND CALCULATION

N/A

DEEMED O&M COST ADJUSTMENT CALCULATION

N/A

¹³¹ Conservative estimate – assumptions outlined in the Wisconsin Focus on Energy 2020 Technical Reference Manual, Grain Dryer Tune-Up (pg. 44).

MEASURE CODE: CI-AGE-DTUNE-V01-250101

REVIEW DEADLINE: 1/1/2027

4.1.16 Greenhouse Boiler Tune-Up

DESCRIPTION

This measure is for a non-residential greenhouse boiler. For space heating other than greenhouses, see measure 4.4.2 Space Heating Boiler Tune-Up. For process heating other than greenhouses, see measure 4.4.3 Process Boiler Tune-Up. The tune-up will improve boiler efficiency by cleaning and/or inspecting burners, combustion chamber, and burner nozzles. Adjust air flow and reduce excessive stack temperatures, adjust burner and gas input. Check venting, safety controls, and adequacy of combustion air intake. Combustion efficiency should be measured before and after tune-up using an electronic flue gas analyzer.

DEFINITION OF EFFICIENT EQUIPMENT

To qualify for this measure the facility must, as applicable, complete the tune-up requirements by approved technician¹³² as specified below:

- Measure combustion efficiency using an electronic flue gas analyzer
- Adjust airflow and reduce excessive stack temperatures
- Adjust burner and gas input, manual or motorized draft control
- Check for proper venting
- Complete visual inspection of system piping and insulation
- Check safety controls
- Check adequacy of combustion air intake
- Clean fireside surfaces
- Inspect all refractory. Patch and wash coat as required.*
- Inspect gaskets on front and rear doors and replace as necessary.*
- Seal and close front and rear doors properly.*
- Clean low and auxiliary low water cut-off controls, then re-install using new gaskets.*
- Clean plugs in control piping.*
- Remove all hand hole and man hole plates. Flush boiler with water to remove loose scale and sediment.*
- Replace all hand hole and man hole plates with new gaskets.*
- Open feedwater tank manway, inspect and clean as required. Replace manway plate with new gasket.*
- Clean burner and burner pilot.
- Check pilot electrode and adjust or replace.
- Clean air damper and blower assembly.
- Clean motor starter contacts and check operation.*
- Make necessary adjustments to burner for proper combustion.
- Perform all flame safeguard and safety trip checks.
- Check all hand hole plates and man hole plates for leaks at normal operating temperatures and pressures.
- Troubleshoot any boiler system problems as requested by on-site personnel

Note: Tune-up activities marked with an asterisk (*) are eligible to be performed by internal maintenance staff at periods of boiler shutdown.

DEFINITION OF BASELINE EQUIPMENT

The baseline condition of this measure is a boiler that has not had a tune-up within the past 36 months.

DEEMED LIFETIME OF EFFICIENT EQUIPMENT

The life of this measure is 3 years.¹³³

¹³² Act on Energy Commercial Technical Reference Manual No. 2010-4, 9.2.2 Gas Boiler Tune-up

¹³³ Act on Energy Commercial Technical Reference Manual No. 2010-4, 9.2.2 Gas Boiler Tune-up

DEEMED MEASURE COST

The cost of this measure is \$0.83/MBtu/hr per tune-up.¹³⁴

DEEMED O&M COST ADJUSTMENTS

N/A

LOADSHAPE

N/A

COINCIDENCE FACTOR

N/A

Algorithm

CALCULATION OF ENERGY SAVINGS

ELECTRIC ENERGY SAVINGS

N/A

SUMMER COINCIDENT PEAK DEMAND SAVINGS

N/A

FOSSIL FUEL SAVINGS

$$\Delta\text{Therms} = ((\text{Capacity} * 8,766 * \text{UF}) / 100) * (1 - (\text{Eff}_{\text{pre}} / \text{Eff}_{\text{measured}}))$$

Where:

Capacity = Boiler gas input size (kBtu/hr)

= Custom

UF = Utilization Factor

= Default Utilization Factor for heating in a greenhouse for agricultural end use are listed in the table below, or use a custom value based on modeling.^{135,136}

Building Type	Heating UF Existing Buildings					Model Source
	Zone 1 (Rockford)	Zone 2 (Chicago)	Zone 3 (Springfield)	Zone 4 (Belleville)	Zone 5 (Marion)	
Greenhouses with curtains	0.473	0.445	0.383	0.328	0.321	Virtual Grower 3.1, with ASHRAE HDD
Greenhouses without curtains	0.476	0.447	0.385	0.330	0.323	Virtual Grower 3.1, with ASHRAE HDD

Eff_{pre} = Boiler Combustion Efficiency Before Tune-Up

¹³⁴ Work Paper – Tune up for Boilers serving Space Heating and Process Load by Resource Solutions Group, January 2012

¹³⁵ Custom site-specific utilization factors for greenhouses can be modeled using the greenhouse configuration and boiler capacity with USDA Virtual Grower software. <https://www.ars.usda.gov/midwest-area/wooster-oh/application-technology-research/docs/virtual-grower/>

¹³⁶ ASHRAE Fundamentals 2017 Chapter 14 Appendix HDD at 65 °F was used to smooth the Virtual Grower software outputs.

= Actual. Default value is 80.3%¹³⁷

Note: Contractors should select a firing rate that appropriately represents the average operating condition and take readings at a consistent firing rate for pre and post tune-up.

Eff_{measured} = Boiler Combustion Efficiency after Tune-Up

= Actual. Default value is 82.6%¹³⁸

100 = Conversion from kBtu to therms

8,766 = Hours per year

For example, a greenhouse 80.3% efficient, 1,050 kBtu boiler is tuned-up resulting in final efficiency of 82.6%:

$$\Delta \text{therms} = ((1,050 * 8,766 * 0.419) / 100) * (1 - (0.803 / 0.826))$$

$$= 1,074 \text{ therms}$$

WATER AND OTHER NON-ENERGY IMPACT DESCRIPTIONS AND CALCULATION

N/A

DEEMED O&M COST ADJUSTMENT CALCULATION

N/A

MEASURE CODE: CI-AGE-GTUNE-V02-250101

REVIEW DEADLINE: 1/1/2028

¹³⁷ Guidehouse evaluation results from tune-up efficiency improvement research for Peoples Gas and North Shore Gas through their C&I and Public Sector Prescriptive Rebate Program, their Small Business Program, and their Multi-Family Programs. The evaluation included project and population data from program year’s 2018 and 2019.

¹³⁸ Guidehouse evaluation results from tune-up efficiency improvement research for Peoples Gas and North Shore Gas through their C&I and Public Sector Prescriptive Rebate Program, their Small Business Program, and their Multi-Family Programs. The evaluation included project and population data from program year’s 2018 and 2019.

4.1.17 Greenhouse Thermal Curtains

DESCRIPTION

Existing greenhouse construction with polyethylene (PE) roofs allows for significant heat loss overnight. The existing PE roofs cause radiant heat to enter the space during daytime, but also lead to heat loss to outside the structure during the night. This can be addressed using thermal curtains which decrease conduction, convection, and radiation heat losses in greenhouses. Thermal curtains are installed inside the greenhouse and are designed to be placed horizontally above the growing zone within a greenhouse. In addition to retaining heat, thermal curtains are commonly used for shading. Thermal insulating curtains are sheets of fabric that extend above the plant growing zone and span the length of the greenhouse. These curtain barriers can reduce nighttime heat loss by more than 20%.¹³⁹ Operation of thermal curtains can be manual or motorized, but must be installed to ensure a tight seal at all connection points.

This measure case is defined as the installation of a single-layer heat curtain with infrared film in a greenhouse area in which a heat curtain was not present. It is assumed that the thermal curtains are deployed during nighttime hours, and open during daytime hours. This measure was developed to be applicable to the following program types: NC, RF. If applied to other program types, the measure savings should be verified.

DEFINITION OF EFFICIENT EQUIPMENT

This measure case is defined as the installation of a single-layer heat curtain with infrared film in a greenhouse area in which a heat curtain was not present. It is assumed that the thermal curtains are deployed during nighttime hours, and open during daytime hours. They can either be manual or motorized thermal curtains installed in greenhouse constructed of PE glazing.

DEFINITION OF BASELINE EQUIPMENT

The baseline equipment is a greenhouse constructed of PE glazing and no thermal curtain.

DEEMED LIFETIME OF EFFICIENT EQUIPMENT

The measure lifetime for greenhouse thermal curtains is 5 years.¹⁴⁰

DEEMED MEASURE COST

Measure cost for greenhouse thermal curtains is \$0.76 per square foot.¹⁴¹

LOADSHAPE

NA

COINCIDENCE FACTOR

NA

Algorithm

CALCULATION OF ENERGY SAVINGS

Energy savings are estimated using EnergyPlus version 9.4 whole-building energy simulation. The greenhouse geometry used in the EnergyPlus model consists of 4 connected bays, each bay with a gable type roof construction, measuring 36 feet wide by 100 feet long. The total conditioned floor area of the modeled greenhouse is 14,210 square feet, and savings are normalized per square foot floor area. The greenhouse is conditioned by gas-fired unit heaters and no cooling system. Greenhouse thermal curtain U values vary depending on the material type like

¹³⁹ Sanford, Scott, College of Agricultural and Life Science, University of Wisconsin Cooperative Extension. *Using Greenhouse Curtains to Reduce Greenhouse Heating and Cooling Costs*.

¹⁴⁰ DEER 2014, <https://cedars.sound-data.com/deer-resources/>

¹⁴¹ Itron, Inc. 2014. *2010-2012 W0017 Ex Ante Measure Cost Study Final Report*. Prepared for the California Public Utilities Commission.

spunbonded polyester, double-knit cloth, aluminized vinyl, aluminum strips, etc. They can have U values as low as 0.26 up to as high as 0.77. However, an average case of 0.483 U value has been simulated here which is assumed to represent a majority of thermal curtains.¹⁴² The area of the thermal curtain equals the conditioned floor area of the greenhouse.

Baseline and efficient models were developed for each Illinois climate zone using inputs for key greenhouse construction characteristics and sources as listed in the following table:

Retrofit:

Input Parameter	Baseline Value	Efficient Value
Roof Glazing	Double PE film, U-value 0.7 (Btu/h · ft ² · °F) ¹⁴³	Same as baseline.
Thermal Curtain	None.	Sunset - Sunrise, U-value 0.483 (Btu/h · ft ² · °F) ¹⁴⁴
Wall Glazing	Single PE film, U-value 1.1 (Btu/h · ft ² · °F) ¹⁴⁵	Same as baseline.
Infiltration	1.5 Air Change per Hour (ACH) ¹⁴⁶	Same as baseline.
Ventilation	10 cubic feet per minute (CFM) per area (ft ²) ¹⁴⁷	Same as baseline.
Heating System	Gas-fired unit heater, 0.8 efficiency	Same as baseline.
Thermostat Setpoint	Heating setpoint 70°F	Same as baseline.
Cooling System	Natural Ventilation	Same as baseline.
Occupancy Schedule	8am – 4pm	Same as baseline.
Lighting Power Density	1.83 watts per square foot ¹⁴⁸	Same as baseline.
Lighting Schedule	Varies monthly based on available daylight hours, supplemental lighting operates between 5 – 11 hours per day to target 20 total light hours. ¹⁴⁹	Same as baseline.

New Construction:¹⁵⁰

Input Parameter	Baseline Value	Efficient Value
-----------------	----------------	-----------------

¹⁴² Bartok, John, Department of Natural Resources Management and Engineering, University of Connecticut, Natural Resource, Agriculture, and Engineering Service (NRAES) Cooperative Extension, Energy Conservation for Commercial Greenhouses, 2001 Revision, Table 4-1 Heat loss through blanket and roof, average of all material types.

¹⁴³ Bartok, Table 1-2 Heat flow u-value for double layer polyethylene film.

¹⁴⁴ Bartok, Table 4-1 Heat loss through blanket and roof, average of all material types.

¹⁴⁵ Bartok, Table 1-2 Heat flow u-value for single layer polyethylene film.

¹⁴⁶ ASHRAE HVAC Applications, Design for Greenhouses, ch. 25.2.1 Table 4, Suggested Design Air Changes for old construction with good maintenance.

¹⁴⁷ Bartok, Chapter 6, page 42.

¹⁴⁸ ASHRAE ch. 25.2.2 Table 10, Suggested Radiant Energy, Duration, and Time of Day for Supplemental Lighting in Greenhouses, average of all W/ft².

¹⁴⁹ ASHRAE ch. 25.2.2 Table 10, Suggested Radiant Energy, Duration, and Time of Day for Supplemental Lighting in Greenhouses, average of all hours.

¹⁵⁰ New construction greenhouses are compliant with IECC 2021 thermal envelope requirements. As code requirements and adoption can differ from municipality to municipality, the user should verify which version of code is applicable given these constraints.

Roof Glazing	Double PE film, U-value 0.5 (Btu/h · ft ² · °F)	Same as baseline.
Thermal Curtain	None.	Sunset - Sunrise, U-value 0.483 (Btu/h · ft ² · °F)
Wall Glazing	Double PE film, U-value 0.7(Btu/h · ft ² · °F)	Same as baseline.
Infiltration	1.5 Air Changes per Hour (ACH)	Same as baseline.
Ventilation	10 cubic feet per minute (CFM) per area (ft ²)	Same as baseline.
Heating System	Gas-fired unit heater, 0.8 efficiency	Same as baseline.
Thermostat Setpoint	Heating setpoint 70°F	Same as baseline.
Cooling System	Natural Ventilation	Same as baseline.
Occupancy Schedule	8am – 4pm	Same as baseline.
Lighting Power Density	1.83 watts per square foot	Same as baseline.
Lighting Schedule	Varies monthly based on available daylight hours, supplemental lighting operates between 5 – 11 hours per day to target 20 total light hours.	Same as baseline.

ELECTRIC ENERGY SAVINGS

NA

SUMMER COINCIDENT PEAK DEMAND SAVINGS

NA

FOSSIL FUEL SAVINGS

Natural gas savings are presented for each climate zone per square foot of greenhouse floor area, which constitutes all floor space under the thermal curtains, including pathways and growing canopy.

Zone	Retrofit Therm Savings per Square Foot	NC Therm Savings per Square Foot
Rockford	0.394	0.275
Chicago	0.361	0.250
Springfield	0.325	0.226
Belleville	0.317	0.222
Marion	0.265	0.191

For example, an existing 15,000 sq.ft greenhouse located in Chicago is retrofitting a thermal curtain with an IR film above the growing zone. The annual savings for the installation will be computed as:

$$\Delta\text{Therms} = 15,000 * 0.361$$

$$= 5,415 \text{ therms.}$$

WATER AND OTHER NON-ENERGY IMPACT DESCRIPTIONS AND CALCULATION

NA

DEEMED O&M COST ADJUSTMENT CALCULATION

NA

MEASURE CODE: CI-AGE-GHEAT-V03-250101

REVIEW DEADLINE: 1/1/2028

4.1.18 Infrared Film for Greenhouse

DESCRIPTION

Existing greenhouse construction with polyethylene (PE) roofs allows for heat transmission loss up to 50%¹⁵¹. The existing PE roofs cause radiant heat to enter the space during daytime, but also lead to heat loss to the outside during the night. This issue can be addressed using Infrared-treated (IR) films. They can be applied on the interior side of the PE roof, reducing heat loss through the roof overnight by absorbing and re-emitting infrared radiation and can reduce heat loss by up to 20%.¹⁵² Reduction in heat loss through the roof overnight reduces the heating load on the greenhouse heating system. This measure applies to greenhouses with polyethylene roof construction.

This measure case is defined as a greenhouse roof with infrared (IR) inhibiting film additive on the inflated double polyethylene roof. This measure was developed to be applicable to the following program types: NC, RF. If applied to other program types, the measure savings should be verified.

DEFINITION OF EFFICIENT EQUIPMENT

The efficient equipment is infrared film installed on the interior of a PE roof glazing in a gas-heated greenhouse. The recommendation is to use one layer of IR film placed as the inner layer of the roof glazing. Doing this allows the wetting agent that is also included in most films to conduct the condensed moisture away.

DEFINITION OF BASELINE EQUIPMENT

The baseline equipment is a gas-heated greenhouse with PE roof glazing construction and no infrared film.

DEEMED LIFETIME OF EFFICIENT EQUIPMENT

The measure lifetime for infrared film is 5 years.¹⁵³

DEEMED MEASURE COST

Incremental cost for IR films installed in new/retrofit applications is \$0.02 per square foot of IR film.¹⁵⁴

LOADSHAPE

N/A

COINCIDENCE FACTOR

N/A

Algorithm

CALCULATION OF ENERGY SAVINGS

Energy savings are estimated using EnergyPlus version 9.4 whole-building energy simulation. The greenhouse geometry used in the EnergyPlus model consists of 4 connected bays, each bay with a gable type roof construction, measuring 36 feet wide by 100 feet long. The total conditioned floor area of the modeled greenhouse is 14,210 square feet, and savings are normalized per square foot of conditioned floor area. The greenhouse is conditioned by gas-fired unit heaters and has no dedicated cooling system. Cooling is typically achieved by natural ventilation and exhaust/ventilations fans in the greenhouse space.

¹⁵¹ Bartok, John, Department of Natural Resources Management and Engineering, University of Connecticut, Natural Resource, Agriculture, and Engineering Service (NRAES) Cooperative Extension, *Energy Conservation for Commercial Greenhouses*, 2001 Revision, Chapter 1, page 4.

¹⁵² DEER 2014. <https://cedars.sound-data.com/deer-resources/>

¹⁵³ Itron, Inc. 2005. *2004-2005 Database for Energy Efficiency Resources (DEER) Update Study – Final Report*. Prepared for Southern California Edison.

¹⁵⁴ Itron, Inc. 2014. *2010-2012 W0017 Ex Ante Measure Cost Study Final Report*. Prepared for the California Public Utilities Commission.

Baseline and efficient models were developed for each Illinois climate zone using inputs for key greenhouse construction characteristics and sources as listed in the following table:

Retrofit:

Input Parameter	Baseline Value	Efficient Value
Roof Glazing	Double PE film, U-value 0.7 (Btu/h · ft ² · °F) ¹⁵⁵	IR-treated double PE film, U-value 0.5 (Btu/h · ft ² · °F) ¹⁵⁶
Wall Glazing	Single PE film, U-value 1.1 (Btu/h · ft ² · °F) ¹⁵⁷	Same as baseline.
Infiltration	1.5 Air Change per Hour (ACH) ¹⁵⁸	Same as baseline.
Ventilation	10 cubic feet per minute (CFM) per area (ft ²) ¹⁵⁹	Same as baseline.
Heating System	Gas-fired unit heater, 0.8 efficiency	Same as baseline.
Thermostat Setpoint	Heating setpoint 70°F	Same as baseline.
Cooling System	Natural Ventilation	Same as baseline.
Occupancy Schedule	8am – 4pm	Same as baseline.
Lighting Power Density	1.83 watts per square foot ¹⁶⁰	Same as baseline.
Lighting Schedule	Varies monthly based on available daylight hours, supplemental lighting operates between 5 – 11 hours per day to target 20 total light hours. ¹⁶¹	Same as baseline.

New Construction:¹⁶²

Input Parameter	Baseline Value	Efficient Value
Roof Glazing	Double PE film, U-value 0.5 (Btu/h · ft ² · °F)	IR-treated double PE film, U-value 0.3 (Btu/h · ft ² · °F)
Wall Glazing	Double PE film, U-value 0.7 (Btu/h · ft ² · °F)	Same as baseline.
Infiltration	1.5 Air Change per Hour (ACH)	Same as baseline.
Ventilation	10 cubic feet per minute (CFM) per area (ft ²)	Same as baseline.
Heating System	Gas-fired unit heater, 0.8 efficiency	Same as baseline.

¹⁵⁵ Bartok, Table 1-2 Heat flow u-value for double layer polyethylene film.

¹⁵⁶ Bartok, Table 1-2 Heat flow u-value for IR-inhibited double layer polyethylene film.

¹⁵⁷ Bartok, Table 1-2 Heat flow u-value for single layer polyethylene film.

¹⁵⁸ ASHRAE HVAC Applications, Design for Greenhouses, ch. 25.2.1 Table 4, Suggested Design Air Changes for old construction with good maintenance.

¹⁵⁹ Bartok, Chapter 6, page 42.

¹⁶⁰ ASHRAE ch. 25.2.2 Table 10, Suggested Radiant Energy, Duration, and Time of Day for Supplemental Lighting in Greenhouses, average of all W/ft².

¹⁶¹ ASHRAE ch. 25.2.2 Table 10, Suggested Radiant Energy, Duration, and Time of Day for Supplemental Lighting in Greenhouses, average of all hours.

¹⁶² New construction greenhouses are compliant with IECC 2021 thermal envelope requirements. As code requirements and adoption can differ from municipality to municipality, the user should verify which version of code is applicable given these constraints.

Input Parameter	Baseline Value	Efficient Value
Thermostat Setpoint	Heating setpoint 70°F	Same as baseline.
Cooling System	Natural Ventilation	Same as baseline.
Occupancy Schedule	8am – 4pm	Same as baseline.
Lighting Power Density	1.83 watts per square foot	Same as baseline.
Lighting Schedule	Varies monthly based on available daylight hours, supplemental lighting operates between 5 – 11 hours per day to target 20 total light hours.	Same as baseline.

ELECTRIC ENERGY SAVINGS

N/A

SUMMER COINCIDENT PEAK DEMAND SAVINGS

N/A

FOSSIL FUEL SAVINGS

Natural gas savings are presented for each climate zone per square foot of greenhouse floor area, which constitutes all floor space under the thermal curtains, including pathways and growing canopy.

Zone	Retrofit Therm Savings per Square Foot of Floor Area	NC Therms Savings per Square Foot of Floor Area
Rockford	0.256	0.314
Chicago	0.232	0.285
Springfield	0.206	0.253
Belleville	0.198	0.245
Marion	0.163	0.212

For example, a 15,000 sq.ft greenhouse located in Chicago is retrofitting its roof glazing material with an infrared film. The annual savings for the installation will be computed as:

$$\text{Savings} = 15,000 * 0.232 = 3,480 \text{ therms.}$$

WATER AND OTHER NON-ENERGY IMPACT DESCRIPTIONS AND CALCULATION

N/A

DEEMED O&M COST ADJUSTMENT CALCULATION

N/A

MEASURE CODE: CI-AGE-GFILM-V02-250101

REVIEW DEADLINE: 1/1/2028

4.1.19 ENERGY STAR Dairy Water Heater

DESCRIPTION

This measure is for upgrading from federal minimum code efficiency to an ENERGY STAR commercial or residential high efficiency water heater on a dairy farm. Water heaters may have a tank for water storage or may be instantaneous. For electric water heaters to be certified by ENERGY STAR, heat pump technology is required. Energy performance of residential water heaters is typically measured by Uniform Energy Factor (UEF) [large sizes are measured by Energy Factor (EF)], gas commercial water heaters are rated by Thermal Efficiency (E_t), and electric commercial water heaters are rated by Coefficient of Performance (COP).

DEFINITION OF EFFICIENT EQUIPMENT

The high efficiency equipment must meet ENERGY STAR specifications.¹⁶³

DEFINITION OF BASELINE EQUIPMENT

Time of sale: The baseline condition is assumed to be a new standard water heater of the same type and service (residential, commercial) as the existing unit being replaced. The new equipment must exceed federal standard efficiency based on equipment type, size category, and subcategory/rating condition.

New Construction: The baseline condition is a new standard water heater of the same type as the efficient, meeting the IECC code level in place at the time the building permit was issued. As code requirements and adoption can differ from municipality to municipality, the user should verify which version of code is applicable given these constraints. Note, IECC 2021 became effective statewide on 1/1/2024. IECC 2018 is the requisite code for any projects with permitting dates spanning July 1, 2019 to 12/31/2023. Prior to July 1, 2019, IECC 2015 is the applicable code

For dairies, efficiency requirements assume a high draw pattern.

Service Type	Equipment Type	Size Category	Federal Minimum Efficiency Requirements ¹⁶⁴
Residential	Gas-Fired Storage Water Heater ≤75,000 Btu/h	≥20 gal and ≤55 gal	$UEF = 0.6920 - 0.0013 \times V_r$
		>55 gal and ≤100 gal	$UEF = 0.8072 - 0.0003 \times V_r$
		> 100 gal	$EF = 0.6200 - 0.0019 \times V_r$
	Gas Fired Instantaneous Water Heater	< 2 gal and > 50,000 Btu/h	$UEF = 0.81$
	Electric Storage Water Heater	≥20 gal and ≤55 gal	$UEF = 0.9349 - 0.0001 \times V_r$
		>55 gal and ≤120 gal	$UEF = 2.2418 - 0.0011 \times V_r$
> 120 gal		$EF = 0.9300 - 0.00132 \times V_r$	
Residential-duty Commercial	High Capacity Storage Gas-Fired Storage Water Heaters > 75,000 Btu/h	≤120 gallon tanks	$UEF = 0.6597 - (0.0009 * V_r)$
Commercial	Gas Storage	Any	80% E_t
	Gas Instantaneous	Any	80% E_t
	Electric Storage	Any	2.18 COP

¹⁶³ ENERGY STAR Program Requirements for Product Specification for Residential Water Heaters, v5.0, effective April 18, 2023. ENERGY STAR Program Requirements Product Specification for Commercial Water Heaters, v2.0, effective October 1, 2018.

¹⁶⁴ Minimum performance rating assumes a high usage draw pattern of 84 gallons per day. A typical dairy in Illinois is estimated to use 131.7 gallons of hot water per day. Please see '4.1.10 Dairy Refrigeration Heat Recovery' for the derivation of the hot water heated on an average dairy farm. Note that minimum performance requirements for residential water heaters toggle between EF and UEF depending on size category based on 'Code of Federal Regulations, federal standards for residential water heaters, 10 CFR 432.32(d)'. Commercial water heaters must meet a minimum Thermal Efficiency (TE) and are subject to maximum standby loss requirements of $Q/800 + 110 \times \sqrt{V_r}$, where Q is the input rating in Btu/hr per '2019 Building Energy Efficiency Standards; 5.3 Mandatory Requirements for Water Heating', California Energy Commission.

DEEMED LIFETIME OF EFFICIENT EQUIPMENT

The expected measure life is assumed to be 15 years for storage units, 20 years for tankless water heaters.¹⁶⁵

DEEMED MEASURE COST

The full install cost and incremental cost assumptions are provided below.¹⁶⁶ Actual costs should be used where available:

Equipment Type	Category	Installed Cost	Incremental Cost
Gas Storage Water Heaters ≥ 75,000 Btu/hr, ≤55 gallons	Baseline	\$616	N/A
	Efficient	\$1,055	\$440
Gas Storage Water Heaters > 75,000 Btuh/h	80% E _t	\$4,886	N/A
	83% E _t	\$5,106	\$220
	84% E _t	\$5,299	\$413
	85% E _t	\$5,415	\$529
	86% E _t	\$5,532	\$646
	87% E _t	\$5,648	\$762
	88% E _t	\$5,765	\$879
	89% E _t	\$5,882	\$996
Electric Storage Water Heaters	90% E _t	\$6,021	\$1,135
	50 gallons		\$1,050
	80 gallons		\$1,050
	100 gallons		\$1,950

LOADSHAPE

For electric hot water heaters, use Loadshape C02 – Commercial Electric DHW.

COINCIDENCE FACTOR

The coincidence factor is assumed to be 0.925.¹⁶⁷

Algorithm

CALCULATION OF ENERGY SAVINGS

ELECTRIC ENERGY SAVINGS

Electric energy savings are calculated for electric water heaters per the equations given below.

$$\Delta kWh = \frac{(T_{OUT} - T_{IN}) * HotWaterUse_{Gallon} * \gamma_{Water} * 1 * \left(\frac{1}{UEF_{elecbase}} - \frac{1}{UEF_{Eff}} \right)}{3412}$$

Where:

¹⁶⁵ Additional reference stating >20 years from the US DOE Energy Savers for Tankless or Demand-Type Water Heaters, and 15 years from the ‘New York Standard Approach for Estimating Energy Savings from Energy Efficiency Programs’, v8.0, effective January 1, 2021.

¹⁶⁶ From the 2010-2012 WO017 Ex Ante Measure Cost Study Final Report from the California Public Utilities Commission Table 3-12.

¹⁶⁷ Coincidence factor based on the average wattage in peak period divided by the maximum wattage from Itron eShape data for Missouri, calibrated to Illinois loads.

T_{OUT}	= Tank Temperature = 170°F ¹⁶⁸
T_{IN}	= Incoming water temperature from well or municipal system or other ¹⁶⁹ = Take measurement if possible, otherwise use the following assumptions. = 52.3°F, average well water temperature if no Dairy Refrigeration Heat Recovery system installed = 120°F, if Dairy Refrigeration Heat Recovery system is operational = 86°F, if unknown ¹⁷⁰
HotWaterUse _{Gallon}	= Estimated annual hot water consumption (gallons) = Actual if possible to provide reasonable custom estimate. If not, use the following formula: = GPD * 365 <div style="margin-left: 40px;">GPD = average gallons of hot water usage per day (=1.30 gallons per cow per day¹⁷¹) * Number of Milking Cows being served by the water heater</div>
γ_{Water}	= Density of Water (lb/gal) = 8.33 lbs/gal
1	= Specific Heat of Water (Btu/lb°F)
UE _{elecbase}	= Rated efficiency of baseline water heater expressed as Uniform Energy Factor (UEF)
UE _{eff}	= Rated efficiency of the efficient water heater expressed as Uniform Energy Factor (UEF) = Actual per ENERGY STAR certified equipment product list
3412	= Converts Btu to kWh

SUMMER COINCIDENT PEAK DEMAND SAVINGS

$$\Delta kW = \frac{\Delta kWh}{Hours} * CF$$

Where:

Hours	= Full load hours of water heater ¹⁷² = 6,461
-------	---

¹⁶⁸ Water heating temperature for dairy farms: The cycle for cleaning needs 170 °F to start and cannot drop below 120°F by the end of the wash cycle. ‘Hot Water for Dairy Farms’, PHCP Pros, Harvey Ramer, May 11, 2017

¹⁶⁹ Expected temperature a refrigeration heat recovery unit can pre-heat well water up to. For more detail, please see: ‘4.1.10 Dairy Refrigeration Heat Recovery.’

¹⁷⁰ Average value assuming 50% of farms have Dairy Refrigeration Heat Recovery system

¹⁷¹ ‘4.1.10 Dairy Refrigeration Heat Recovery’ details average default values for hot water use and number of milking cows if unknown. The 1.30 gallons of hot water per day is calculated from (131.7 GPD/101 cows). This value is corroborated by milking system washing hot water consumption of 5L per cow (1.32 gallons per cow) per Shortall J. et al. and supported by data from NYSERDA Dairy Farm Audit Summary, in which 10 dairy farms averaged of 1.40 gallons of hot water per cow per day based on measured electric water heater energy consumption and assumed 98% efficiency.

¹⁷² Full load hours assumption based on Wh/Max W Ratio from Itron eShape data for Missouri, calibrated to Illinois loads.

CF = Summer Peak Coincidence Factor for measure
 = 0.925¹⁷³

For example, a residential ENERGY STAR water heater of 100 gallons rated capacity and UEF of 3.5 will be serving hot water to 101 cows milked daily. The farm does not currently have any dairy refrigeration heat recovery system so they are directly getting the water from a well and heating it to 170°F to clean the milking equipment.

$$\Delta kWh = \frac{(T_{OUT} - T_{IN}) * HotWaterUse_{Gallon} * \gamma_{Water} * 1 * \left(\frac{1}{UEF_{elecbase}} - \frac{1}{UEF_{Eff}} \right)}{3,412}$$

$$\Delta kWh = \frac{(170 \text{ °F} - 52.3 \text{ °F}) * 101 \text{ cows} * \frac{1.30 \text{ gal}}{\text{cow}} * \frac{\text{day}}{\text{day}} * 8.33 \frac{\text{lb}}{\text{gal}} * 1 \frac{\text{Btu}}{\text{lb}^\circ\text{F}} * \left(\frac{1}{(2.2418 - 0.0011 \times 100)} - \frac{1}{3.5} \right)}{3,412 \frac{\text{Btu}}{\text{kWh}}}$$

$$* 365 \frac{\text{days}}{\text{yr}}$$

$$= 2,527 \text{ kWh}$$

For Demand Saving:

$$\Delta kW = \frac{\Delta kWh}{Hours} * CF$$

$$\Delta kW = \frac{2,527}{6,461} * 0.925 = 0.36 \text{ kW}$$

FOSSIL FUEL SAVINGS

Natural gas energy savings are calculated for natural gas storage water heaters per the equations given below.

$$\Delta Therms = \frac{(T_{out} - T_{in}) * HotWaterUse_{Gallon} * \gamma_{Water} * 1 * \left(\frac{1}{UEF_{gasbase}} - \frac{1}{UEF_{Eff}} \right)}{100,000}$$

Where:

100,000 = Converts Btu to Therms

¹⁷³ Coincidence factor based on Average W in peak period/Max W from Itron eShape data for Missouri, calibrated to Illinois loads.

UEF_{gasbase} = Rated efficiency of baseline water heater (Expressed as Uniform Energy Factor (UEF)).

For example, a 150,000 Btu/h gas storage water heater of 100 gallons rated volume and UEF of 0.9 delivers hot water for 101 cows milked daily. The farm has a dairy refrigeration heat recovery system that supplies 120 °F water to the heater. The farm uses 170°F hot water for milking equipment cleaning.

$$\Delta Therms = \frac{(T_{OUT} - T_{IN}) \times HotWaterUse_{Gallon} \times \gamma_{Water}}{100,000 \frac{Btu}{therm}} \times 1 \times \left(\frac{1}{UEF_{gasbase}} - \frac{1}{UEF_{Eff}} \right)$$

$$\Delta Therms = \frac{(170 - 120)^{\circ}F \times 101 \text{ cows} \times \frac{1.30 \text{ gal}}{\text{day}} \times 365 \frac{\text{days}}{\text{yr}} \times 8.33 \frac{\text{lb}}{\text{gal}}}{100,000 \frac{Btu}{Therm}} \times \left(\frac{1}{0.8072 - 0.0003 \times 100} - \frac{1}{0.9} \right) \times 365 \frac{\text{Days}}{\text{yr}}$$

$$\Delta Therms = 35 \text{ Therms}$$

WATER AND OTHER NON-ENERGY IMPACT DESCRIPTIONS AND CALCULATION

N/A

DEEMED O&M COST ADJUSTMENT CALCULATION

N/A

MEASURE CODE: CI-AGE-ESWH-V04-250101

REVIEW DEADLINE: 1/1/2028

4.1.20 Commercial Electric Lawn Mower

DESCRIPTION

This measure identifies the claimed savings associated with commercial lawn mower electrification. This measure was developed to be applicable to the following program types: TOS.

Time of Sale (TOS):

- The use of all-electric equipment in place of a device with a spark-ignition gasoline-powered engine.
- Note that the baseline in this case is an equivalent replacement system to that which exists currently in the business.

If applied to other program types, the measure savings should be verified.

DEFINITION OF EFFICIENT EQUIPMENT

The efficient condition is an all-electric lawn mower sized to be equivalent to the baseline gasoline-powered mower.

DEFINITION OF BASELINE EQUIPMENT

The baseline condition is a new gasoline-powered lawn mower.

DEEMED LIFETIME OF EFFICIENT EQUIPMENT

The expected measure life varies based on the equipment type (displayed in the table below).

Equipment Type	Measure Life (years) ¹⁷⁴
Riding Lawn Mower	10
Push Lawn Mower	10

DEEMED MEASURE COST

For Time of Sale (TOS) the incremental cost should be used. Actual costs can also be used although care should be taken as costs can vary significantly. Defaults are provided below.

Equipment Type	Incremental Cost ¹⁷⁵
Riding Lawn Mower	\$21,373
Push Lawn Mower	\$500

LOADSHAPE

Loadshape C03 – Commercial Cooling¹⁷⁶

COINCIDENCE FACTOR

The summer Peak Coincidence Factor is assumed to be 91.3%.¹⁷⁷

¹⁷⁴ Conservative estimate given lack of definitive source. Useful life for commercial gasoline-powered mowers is 5 years, per CARB (2022). CCI Emission Factor Database, “Fuel-Specific GHG” worksheet, available at [cci_emissionfactordatabase_2022-11-30.xlsx \(live.com\)](https://cci-emissionfactordatabase.com/2022-11-30.xlsx). Electric mowers may last significantly longer. Manufacturers estimate 3,000-5,000 hours for electric mowers, according to [The Electric Advantage - MEAN GREEN MOWERS \(meangreenproducts.com\)](https://www.meangreenproducts.com/), which equates to more than 10 years at 246 hours per year.

¹⁷⁵ Vermont Act 56 Tier III Technical Advisory Group 2021 ANNUAL REPORT

¹⁷⁶ Commercial cooling loadshape is used as an estimate of likely usage pattern for electric lawn equipment. This methodology is used in other jurisdictions offering electric lawn care equipment savings.

¹⁷⁷ Based on analysis of Itron eShape data for Missouri, calibrated to Illinois loads, supplied by Ameren. The AC load during the utility’s peak hour is divided by the maximum AC load during the year.

Algorithm

CALCULATION OF ENERGY SAVINGS

ELECTRIC ENERGY AND FOSSIL FUEL SAVINGS

Fuel switch measure (baseline is gas equipment):

Fuel switch / electrification measures must produce positive total energy savings (i.e., reduction in Btus at the premises) in order to qualify. This is determined as follows:

$$\begin{aligned} \Delta \text{SiteEnergySavings (MMBtu)} &= [\text{GasConsumptionReplaced}] - [\text{ElectricConsumptionAdded}] \\ &= [\text{Fuel}_{\text{baseline}} * 120,238/1,000,000] - [\text{Fuel}_{\text{baseline}} * \text{ED}_{\text{gasoline}} / (\text{ED}_{\text{electricity}} * \text{EER}_{\text{G} \rightarrow \text{E}}) * 3,412/1,000,000] \\ \text{Fuel}_{\text{baseline}} &= (\text{BSFC}_{\text{baseline}} * \text{hp}_{\text{baseline}} * \text{LF}_{\text{baseline}} * \text{Hours}) / (\text{Fuel Density}_{\text{gasoline}}) \end{aligned}$$

If SiteEnergySavings calculated above is positive, the measure is eligible.

The appropriate savings claim is dependent on which utilities are supporting the measure as provided in a table below:

Measure Supported By:	Electric Utility Claims (kWh):	Gas Utility Claims (therms):
Electric utility only	SiteEnergySavings * 1,000,000/3,412	N/A
Electric and gas utility (Note utilities may make alternative agreements to how savings are allocated as long as total MMBtu savings remains the same).	%IncentiveElectric * SiteEnergySavings * 1,000,000/3,412	%IncentiveGas * SiteEnergySavings * 10
Gas utility only	N/A	SiteEnergySavings * 10

Where:

- BSFC_{baseline} = Brake Specific Fuel (Gasoline) Consumption Factor (lbs/hp-hr)
= If unknown, use default values in the table below
- hp_{baseline} = Horsepower of the lawn mower
= If unknown, use default values in the table below
- LF_{baseline} = The load factor is the average operational level of an engine as a fraction or percentage of the engine manufacturer’s maximum rated horsepower. Load factor is difficult to characterize since it is a strong function of the equipment use and operation. Load factors for various equipment types are presented in the table below.
- Hours = Annual operating hours of the lawn mower.
= Values for various equipment types are presented in the table below.
- Fuel Density_{gasoline} = Gasoline fuel density (assume 6.15 lbs/gal)¹⁷⁸

¹⁷⁸ CARB (2022). CCI Emission Factor Database, “Fuel-Specific GHG” worksheet, available at [cci_emissionfactordatabase_2022-11-30.xlsx \(live.com\)](https://www.cci-emissionfactordatabase.com/2022-11-30.xlsx).

- ED_{gasoline} = Energy density of gasoline (assume 115.83 MJ/gal)¹⁷⁸
- $ED_{\text{electricity}}$ = Energy density of electricity = 3.6 MJ/kWh
- $EER_{G \rightarrow E}$ = Energy Economy Ratio = 3.4 (for switching from gasoline to electricity)¹⁷⁹
- 120,238 = Btu content in one gallon of finished gasoline¹⁸⁰
- 1,000,000 = Btu to MMBtu conversion

Equipment Type	$BSFC_{\text{baseline}}$ (lbs/hp-hr) ¹⁸⁶	hp_{baseline} ¹⁸⁶	LF_{baseline} ¹⁸¹	Hours (hrs/year)	ΔkWh	$\Delta MMBtu$	Site Energy Savings (MMBtu)
Riding Lawn Mower	0.775	21.4	38%	246	-2386	30.3	22.2
Push Lawn Mower	0.789	3.9	33%	161.6	-253	3.2	2.3

For example, using the default assumptions on the application of a riding lawn mower:

$$Fuel_{\text{baseline}} = (0.775 * 21.4 * 0.38 * 246) / 6.15$$

$$= 252.09$$

$$SiteEnergySavings \text{ (MMBtu)} = (252.09 * 120,238 / 1,000,000) - (252.09 * 115.83 / (3.6 * 3.4)) * 3,412 / 1,000,000$$

$$= 22.2 \text{ MMBtu}$$

SUMMER COINCIDENT PEAK DEMAND SAVINGS

$$\Delta kW = -1 * kW_{\text{battery draw}} * CF$$

Where:

$kW_{\text{battery draw}}$ = The electric draw by the battery during charging. This varies based on the battery and charger specifications. If unknown use values in the table below.

Equipment Type	$kW_{\text{battery draw}}$
Riding Lawn Mower	1.12 ¹⁸²
Push Lawn Mower	0.42 ¹⁸³

¹⁷⁹ Energy Economy Ratio (EER) dimensionless value that represents the efficiency of a fuel as used in a powertrain as compared to a reference fuel used in the same powertrain. Source: CARB (2018), Low Carbon Fuel Standard Regulations: Table 5. EER Values for Fuels Used in Light- and Medium- Duty, and Heavy-Duty Applications. [RESO 18-34 LCFS Attachment A Final Reg Order \(ca.gov\)](#)

¹⁸⁰ [Energy conversion calculators - U.S. Energy Information Administration \(EIA\)](#)

¹⁸¹ Conservative estimate given lack of definitive source. Useful life for commercial gasoline-powered mowers is 5 years, per CARB (2022). CCI Emission Factor Database, “Fuel-Specific GHG” worksheet, available at [cci emissionfactordatabase 2022-11-30.xlsx \(live.com\)](#). Electric mowers may last significantly longer. Manufacturers estimate 3,000-5,000 hours for electric mowers, according to [The Electric Advantage - MEAN GREEN MOWERS \(meangreenproducts.com\)](#), which equates to more than 10 years at 246 hours per year.

¹⁸² Vermont Act 56 Tier III Technical Advisory Group 2021 ANNUAL REPORT

¹⁸³ Massachusetts Residential Baseline Study, Guidehouse, 2020

CF = Summer Peak Coincidence Factor
= 91.3%¹⁸⁴

WATER AND OTHER NON-ENERGY IMPACT DESCRIPTIONS AND CALCULATION

N/A

DEEMED O&M COST ADJUSTMENT CALCULATION

Replacement battery costs should be accounted for if likely to be required within the 10 year measure life.

MEASURE CODE: CI-AGE-CELM-V02-250101

REVIEW DEADLINE: 1/1/2028

¹⁸⁴ Based on analysis of Itron eShape data for Missouri, calibrated to Illinois loads, supplied by Ameren. The AC load during the utility's peak hour is divided by the maximum AC load during the year.

4.2. Food Service End Use

4.2.1 Combination Oven

DESCRIPTION

This measure applies to both natural gas fired and electric high efficiency combination convection and steam ovens installed in a commercial kitchen.

This measure was developed to be applicable to the following program types: TOS, RF. If applied to other program types, the measure savings should be verified.

DEFINITION OF EFFICIENT EQUIPMENT

To qualify for this measure, the installed equipment must be a new natural gas or electric combination oven meeting the ENERGY STAR idle rate and cooking efficiency requirements as specified below.¹⁸⁵

ENERGY STAR Requirements (Version 3.0, Effective January 12, 2023)

Fuel Type	Operation	Idle Rate (Btu/h for Gas, kW for Electric)	Cooking-Energy Efficiency, (%)
Natural Gas (5-40 Pan Capacity)	Steam Mode	$\leq 200P+6,511$	≥ 41
	Convection Mode	$\leq 140P+3,800$	≥ 57
Electric (5-40 Pan Capacity)	Steam Mode	$\leq 0.133P+0.6400$	≥ 55
	Convection Mode	$\leq 0.083P+0.35$	≥ 78
Electric (3-4 Pan Capacity)	Steam Mode	$\leq 0.60P$	≥ 51
	Convection Mode	$\leq 0.05P+0.55$	≥ 70

Note: P = Pan capacity as defined in Section 1.Y, of the Commercial Ovens Program Requirements Version 3.0¹⁸⁶

DEFINITION OF BASELINE EQUIPMENT

The baseline equipment is a natural gas or electric combination oven that is not ENERGY STAR certified.

DEEMED LIFETIME OF EFFICIENT EQUIPMENT

The expected measure life is assumed to be 12 years.¹⁸⁷

DEEMED MEASURE COST

The costs vary based on the efficiency and make of the equipment. Actual costs should be used. Otherwise¹⁸⁸:

Oven Type & Capacity	Baseline Cost	Efficient Cost	Incremental Measure Cost
Electric < 15 Pan Capacity	\$13,919	\$16,189	\$2,269
Electric 15 – 30 Pan Capacity	\$18,966	\$21,247	\$2,281
Electric > 30 Pan Capacity	\$30,827	\$34,625	\$3,798
Gas < 15 Pan Capacity	\$15,406	\$19,338	\$3,932
Gas 15 – 30 Pan Capacity	\$20,292	\$24,509	\$4,217
Gas > 30 Pan Capacity	\$32,508	\$38,337	\$5,829

¹⁸⁵ ENERGY STAR Commercial Ovens Key Product Criteria, version 3.0, effective January 12, 2023

¹⁸⁶ Ibid. Pan capacity is defined as the number of steam table pans the combination oven is able to accommodate as per the ASTM F-1495-05 standard specification.

¹⁸⁷ The measure life is sourced from the Food Service Technology Center’s energy savings calculator for combination ovens.

¹⁸⁸ Costs are sourced from Food Service Technology Center 2016 ‘Combi_2016_Prices_Updated’ which is also used in the ENERGY STAR Commercial Foodservice Savings Calculator, published March, 2021.

LOADSHAPE

Loadshape C01 - Commercial Electric Cooking

COINCIDENCE FACTOR

Summer Peak Coincidence Factor for measure is assumed to be 0.90.¹⁸⁹

Algorithm

CALCULATION OF SAVINGS

ELECTRIC ENERGY AND FOSSIL FUEL SAVINGS¹⁹⁰

Non-Fuel Switch Measures

The algorithm below applies to electric combination ovens only.

$$\Delta kWh = (\Delta CookingEnergy_{ConvElec} + \Delta CookingEnergy_{SteamElec} + \Delta IdleEnergy_{ConvElec} + \Delta IdleEnergy_{SteamElec} + \Delta PreHeatEnergy_{Elec}) * Days / 1,000$$

The algorithm below applies to natural gas combination ovens only.

$$\Delta Therms = (\Delta CookingEnergy_{ConvGas} + \Delta CookingEnergy_{SteamGas} + \Delta IdleEnergy_{ConvGas} + \Delta IdleEnergy_{SteamGas} + \Delta PreHeatEnergy_{Gas}) * Days / 100,000$$

Fuel Switch/Electrification Measures

Fuel switch / electrification measures must produce positive total energy savings (i.e., reduction in Btus at the premises) in order to qualify. This is determined as follows:

$$\begin{aligned} \text{SiteEnergySavings (MMBTUs)} &= [\text{GasConsumptionReplaced}] - [\text{ElectricConsumptionAdded}] \\ &= [(\text{CookingEnergy}_{ConvGasBase} + \text{CookingEnergy}_{SteamGasBase} + \text{IdleEnergy}_{ConvGasBase} + \text{IdleEnergy}_{SteamGasBase} + \text{PreHeatEnergy}_{BaseGas}) * \text{Days} / 1,000,000] - \\ &\quad [(\text{CookingEnergy}_{ConvElecEE} + \text{CookingEnergy}_{SteamElecEE} + \text{IdleEnergy}_{ConvElecEE} + \text{IdleEnergy}_{SteamElecEE} + \text{PreHeatEnergy}_{EEElec}) * \text{Days} * 3.412 / 1,000,000] \end{aligned}$$

If SiteEnergySavings calculated above is positive, the measure is eligible.

The appropriate savings claim is dependent on which utilities are supporting the measure as provided in a table below:

Measure Supported By:	Electric Utility Claims (kWh):	Gas Utility Claims (therms):
Electric utility only	SiteEnergySavings * 1,000,000/3,412	N/A
Electric and gas utility	%IncentiveElectric * SiteEnergySavings *	%IncentiveGas * SiteEnergySavings * 10

¹⁸⁹ Itron, Inc. 2005. 2004-2005 Database for Energy Efficiency Resources (DEER) Update Study - Final Report. Prepared for Southern California Edison.

¹⁹⁰ Algorithms and assumptions derived from ENERGY STAR Commercial Kitchen Equipment Savings Calculator, updated March 2021.

Measure Supported By:	Electric Utility Claims (kWh):	Gas Utility Claims (therms):
(Note utilities may make alternative agreements to how savings are allocated as long as total MMBtu savings remains the same).	1,000,000/3,412	
Gas utility only	N/A	SiteEnergySavings * 10

Where:

- $\Delta\text{CookingEnergy}_{\text{ConvElec}}$ = Change in total daily cooking energy consumed by electric oven in convection mode
 $= \text{LB}_{\text{Elec}} * (\text{EFOOD}_{\text{ConvElec}} / \text{ElecEFF}_{\text{ConvBase}} - \text{EFOOD}_{\text{ConvElec}} / \text{ElecEFF}_{\text{ConvEE}}) * \%_{\text{Conv}}$
- $\Delta\text{CookingEnergy}_{\text{SteamElec}}$ = Change in total daily cooking energy consumed by electric oven in steam mode
 $= \text{LB}_{\text{Elec}} * (\text{EFOOD}_{\text{SteamElec}} / \text{ElecEFF}_{\text{SteamBase}} - \text{EFOOD}_{\text{SteamElec}} / \text{ElecEFF}_{\text{SteamEE}}) * \%_{\text{Steam}}$
- $\Delta\text{IdleEnergy}_{\text{ConvElec}}$ = Change in total daily idle energy consumed by electric oven in convection mode
 $= [(\text{ElecIDLE}_{\text{ConvBase}} * ((\text{HOURS} - \text{LB}_{\text{Elec}}/\text{ElecPC}_{\text{ConvBase}}) * \%_{\text{Conv}})) - (\text{ElecIDLE}_{\text{ConvEE}} * ((\text{HOURS} - \text{LB}_{\text{Elec}}/\text{ElecPC}_{\text{ConvEE}}) * \%_{\text{Conv}}))]$
- $\Delta\text{IdleEnergy}_{\text{SteamElec}}$ = Change in total daily idle energy consumed by electric oven in steam mode
 $= [(\text{ElecIDLE}_{\text{SteamBase}} * ((\text{HOURS} - \text{LB}_{\text{Elec}}/\text{ElecPC}_{\text{SteamBase}}) * \%_{\text{Steam}})) - (\text{ElecIDLE}_{\text{SteamEE}} * ((\text{HOURS} - \text{LB}_{\text{Elec}}/\text{ElecPC}_{\text{SteamEE}}) * \%_{\text{Steam}}))]$
- $\Delta\text{PreHeatEnergy}_{\text{Elec}}$ = Change in total daily energy consumed by electric oven to preheat
 $= \text{Preheat}_{\text{BaseElec}} - \text{Preheat}_{\text{EEElec}}$
- $\Delta\text{CookingEnergy}_{\text{ConvGas}}$ = Change in total daily cooking energy consumed by gas oven in convection mode
 $= \text{LB}_{\text{Gas}} * (\text{EFOOD}_{\text{ConvGas}} / \text{GasEFF}_{\text{ConvBase}} - \text{EFOOD}_{\text{ConvGas}} / \text{GasEFF}_{\text{ConvEE}}) * \%_{\text{Conv}}$
- $\Delta\text{CookingEnergy}_{\text{SteamGas}}$ = Change in total daily cooking energy consumed by gas oven in steam mode
 $= \text{LB}_{\text{Gas}} * (\text{EFOOD}_{\text{SteamGas}} / \text{GasEFF}_{\text{SteamBase}} - \text{EFOOD}_{\text{SteamGas}} / \text{GasEFF}_{\text{SteamEE}}) * \%_{\text{Steam}}$
- $\Delta\text{IdleEnergy}_{\text{ConvGas}}$ = Change in total daily idle energy consumed by gas oven in convection mode
 $= [(\text{GasIDLE}_{\text{ConvBase}} * ((\text{HOURS} - \text{LB}_{\text{Gas}}/\text{GasPC}_{\text{ConvBase}}) * \%_{\text{Conv}})) - (\text{GasIDLE}_{\text{ConvEE}} * ((\text{HOURS} - \text{LB}_{\text{Gas}}/\text{GasPC}_{\text{ConvEE}}) * \%_{\text{Conv}}))]$
- $\Delta\text{IdleEnergy}_{\text{SteamGas}}$ = Change in total daily idle energy consumed by gas oven in steam mode
 $= [(\text{GasIDLE}_{\text{SteamBase}} * ((\text{HOURS} - \text{LB}_{\text{Gas}}/\text{GasPC}_{\text{SteamBase}}) * \%_{\text{Steam}})) - (\text{GasIDLE}_{\text{SteamEE}} * ((\text{HOURS} - \text{LB}_{\text{Gas}}/\text{GasPC}_{\text{SteamEE}}) * \%_{\text{Steam}}))]$
- $\Delta\text{PreHeatEnergy}_{\text{Gas}}$ = Change in total daily energy consumed by gas oven to preheat
 $= \text{Preheat}_{\text{BaseGas}} - \text{Preheat}_{\text{EEGas}}$

- CookingEnergy_{ConvElecEE}** = Total daily cooking energy consumed by new ENERGY STAR electric oven in convection mode (for fuel switch measure)

= $LB_{Elec} * (E_{FOOD_{ConvElec}} / ElecEFF_{ConvEE}) * \%_{Conv}$
- CookingEnergy_{SteamElecEE}** = Total daily cooking energy consumed by new ENERGY STAR electric oven in steam mode (for fuel switch measure)

= $LB_{Elec} * (E_{FOOD_{SteamElec}} / ElecEFF_{SteamEE}) * \%_{Steam}$
- IdleEnergy_{ConvElecEE}** = Total daily idle energy consumed by new ENERGY STAR electric oven in convection mode (for fuel switch measure)

= $(ElecIDLE_{ConvEE} * ((HOURS - LB_{Elec}/ElecPC_{ConvEE}) * \%_{Conv}))$
- IdleEnergy_{SteamElecEE}** = Total daily idle energy consumed by new ENERGY STAR electric oven in convection mode (for fuel switch measure)

= $(ElecIDLE_{SteamEE} * ((HOURS - LB_{Elec}/ElecPC_{SteamEE}) * \%_{Steam}))$
- CookingEnergy_{ConvGasBase}** = Total daily cooking energy consumed by baseline gas oven in convection mode (for fuel switch measure)

= $LB_{Gas} * (E_{FOOD_{ConvGas}} / GasEFF_{ConvBase}) * \%_{Conv}$
- CookingEnergy_{SteamGasBase}** = Total daily cooking energy consumed by baseline gas oven in steam mode (for fuel switch measure)

= $LB_{Gas} * (E_{FOOD_{SteamGas}} / GasEFF_{SteamBase}) * \%_{Steam}$
- IdleEnergy_{ConvGasBase}** = Total daily idle energy consumed by baseline gas oven in convection mode (for fuel switch measure)

= $(GasIDLE_{ConvBase} * ((HOURS - LB_{Gas}/GasPC_{ConvBase}) * \%_{Conv}))$
- IdleEnergy_{SteamGasBase}** = Total daily idle energy consumed by baseline gas oven in convection mode (for fuel switch measure)

= $[(GasIDLE_{SteamBase} * ((HOURS - LB_{Gas}/GasPC_{SteamBase}) * \%_{Steam}))]$

Where:

- LB_{Elec}** = Estimated mass of food cooked per day for electric oven (lbs/day)

= Custom, or if unknown, use 200 lbs (If P <15) or 250 lbs (If P >= 15)
- E_{FOOD_{ConvElec}}** = Energy absorbed by food product for electric oven in convection mode

= Custom or if unknown, use 73.2 Wh/lb
- ElecEFF** = Cooking energy efficiency of electric oven

= Custom or if unknown, use values from table below

	Base	EE
ElecEFF _{Conv}	72%	78%
ElecEFF _{Steam}	52%	55%

- %_{Conv}** = Percentage of time in convection mode

= Custom or if unknown, use 50%

$E_{FOOD_{SteamElec}}$ = Energy absorbed by food product for electric oven in steam mode

= Custom or if unknown, use 30.8 Wh/lb

$\%_{steam}$ = Percentage of time in steam mode

= $1 - \%_{conv}$

$E_{IdleDLE_{Base}}$ = Idle energy rate (W) of baseline electric oven

= Custom or if unknown, use values from table below

Pan Capacity	Convection Mode ($E_{IdleDLE_{ConvBase}}$)	Steam Mode ($E_{IdleDLE_{SteamBase}}$)
< 15	1,754	5,260
>= 15 to <30	2,966	8,866
>= 30	4,418	11,875

HOURS = Average daily hours of operation

= Custom or if unknown, use 12 hours

$E_{lecPC_{Base}}$ = Production capacity (lbs/hr) of baseline electric oven

= Custom of if unknown, use values from table below

Pan Capacity	Convection Mode ($E_{lecPC_{ConvBase}}$)	Steam Mode ($E_{lecPC_{SteamBase}}$)
< 15	79	126
>= 15	166	295

$E_{IdleDLE_{ConvEE}}$ = Idle energy rate of ENERGY STAR electric oven in convection mode

= Custom or if unknown, use default below:

= $(0.083 * P + 0.350) * 1000$ for 5-40 Pan Capacity

= $(0.05 * P + 0.55) * 1000$ for 3-4 Pan Capacity

$E_{lecPCEE}$ = Production capacity (lbs/hr) of ENERGY STAR electric oven

= Custom of if unknown, use values from table below

Pan Capacity	Convection Mode ($E_{lecPCE_{ConvEE}}$)	Steam Mode ($E_{lecPCE_{SteamEE}}$)
< 15	119	177
>= 15	201	349

$E_{IdleDLE_{SteamEE}}$ = Idle energy rate of ENERGY STAR electric oven in steam mode

= Custom or if unknown, use default below:

= $(0.133 * P + 0.64) * 1000$ for 5-40 Pan Capacity

= $(0.60 * P) * 1000$ for 3-4 Pan Capacity

$Preheat_{BaseElec}$ = Total preheat energy consumption per day of baseline electric unit (Wh)

= Custom or if unknown, use default below:

Pan Capacity	$Preheat_{BaseElec}$
< 15	1,635

Pan Capacity	Preheat _{BaseElec}
> = 15	3,146

Preheat_{EEElec} = Total preheat energy consumption per day of ENERGY STAR electric unit (Wh)

Pan Capacity	Preheat _{EEElec}
< 15	997
> = 15	1,633

Days = Days of operation per year
 = Custom or if unknown, use 365 days per year

1,000 = Wh to kWh conversion factor

LB_{Gas} = Estimated mass of food cooked per day for gas oven (lbs/day)
 = Custom, or if unknown, use 200 lbs (If P <15), 250 lbs (If 15 <= P 30), or 400 lbs (If P = >30)

EFOOD_{ConvGas} = Energy absorbed by food product for gas oven in convection mode
 = Custom or if unknown, use 250 Btu/lb

GasEFF = Cooking energy efficiency of gas oven
 = Custom or if unknown, use values from table below

	Base	EE
GasEFF _{Conv}	49%	57%
GasEFF _{Steam}	37%	41%

EFOOD_{SteamGas} = Energy absorbed by food product for gas oven in steam mode
 = Custom or if unknown, use 105 Btu/lb

GasIDLE_{Base} = Idle energy rate (Btu/hr) of baseline gas oven
 = Custom or if unknown, use values from table below

Pan Capacity	Convection Mode (GasIDLE _{ConvBase})	Steam Mode (GasIDLE _{SteamBase})
< 15	9,840	24,003
15-30	11,734	27,795
>30	15,376	27,957

GasPC_{Base} = Production capacity (lbs/hr) of baseline gas oven
 = Custom of if unknown, use values from table below

Pan Capacity	Convection Mode (GasPC _{ConvBase})	Steam Mode (GasPC _{SteamBase})
< 15	125	195
15-30	176	211
>30	392	579

GasIDLE_{ConvEE} = Idle energy rate of ENERGY STAR gas oven in convection mode

= Custom or if unknown, use default below:

$$= 140 * P + 3,800$$

GasPC_{EE}

= Production capacity (lbs/hr) of ENERGY STAR gas oven

= Custom of if unknown, use values from table below

Pan Capacity	Convection Mode (GasPC _{ConvEE})	Steam Mode (GasPC _{SteamEE})
< 15	124	172
15-30	210	277
>30	394	640

GasIDLE_{SteamEE}

= Idle energy rate of ENERGY STAR gas oven in steam mode

= Custom or if unknown, use default below:

$$= 200 * P + 6511$$

Preheat_{BaseGas}

= Total preheat energy consumption per day of baseline gas unit (BTU)

= Custom or if unknown, use default below:

Pan Capacity	Preheat _{BaseGas}
< 15	10,964
> = 15	15,844

Preheat_{EEGas}

= Total preheat energy consumption per day of ENERGY STAR gas unit (BTU)

= Custom or if unknown, use default below:

Pan Capacity	Preheat _{EEGas}
< 15	4,467
> = 15	10,638

100,000

= Conversion factor from Btu to therms

3.412

= Conversion factor from Wh to Btu

1,000,000

= Conversion factor from Btu to MMBtu

For example, a 10-pan capacity ENERGY STAR electric combination oven in place of a baseline electric oven would save:

$$\begin{aligned} \Delta \text{kWh} &= (\Delta \text{CookingEnergy}_{\text{ConvElec}} + \Delta \text{CookingEnergy}_{\text{SteamElec}} + \Delta \text{IdleEnergy}_{\text{ConvElec}} + \Delta \text{IdleEnergy}_{\text{SteamElec}} + \\ &\quad \Delta \text{PreHeatEnergy}_{\text{Elec}}) * \text{Days} / 1,000 \\ \Delta \text{CookingEnergy}_{\text{ConvElec}} &= 200 * (73.2 / 0.72 - 73.2 / 0.78) * 0.50 \\ &= 782 \text{ Wh} \\ \Delta \text{CookingEnergy}_{\text{SteamElec}} &= 200 * (30.8 / 0.52 - 30.8 / 0.55) * (1 - 0.50) \\ &= 323 \text{ Wh} \\ \Delta \text{IdleEnergy}_{\text{ConvElec}} &= [(1,754 * ((12 - 200/79) * 0.50)) - (1,180 * ((12 - 200/119) * 0.50))] \\ &= 2,215 \text{ Wh} \\ \Delta \text{IdleEnergy}_{\text{SteamElec}} &= [(5,260 * ((12 - 200/126) * (1 - 0.50))) - (1,970 * ((12 - 200/177) * (1 - \\ &\quad 0.50)))] \\ &= 16,678 \text{ Wh} \\ \Delta \text{PreHeatEnergy}_{\text{Elec}} &= 1,635 - 997 \\ &= 638 \text{ Wh} \\ \Delta \text{kWh} &= (782 + 323 + 2215 + 16,678 + 638) * 365 / 1,000 \\ &= 7,532 \text{ kWh} \end{aligned}$$

For example, an ENERGY STAR 10-pan capacity electric combination oven in place of a baseline gas combination oven would save:

$$\begin{aligned} \text{SiteEnergySavings (MMBTUs)} &= [\text{GasConsumptionReplaced}] - [\text{ElectricConsumptionAdded}] \\ &= [(\text{CookingEnergy}_{\text{ConvGasBase}} + \text{CookingEnergy}_{\text{SteamGasBase}} + \text{IdleEnergy}_{\text{ConvGasBase}} + \text{IdleEnergy}_{\text{SteamGasBase}} + \text{PreHeatEnergy}_{\text{BaseGas}}) \\ &\quad * \text{Days} / 1,000,000] - \\ &\quad [(\text{CookingEnergy}_{\text{ConvElecEE}} + \text{CookingEnergy}_{\text{SteamElecEE}} + \text{IdleEnergy}_{\text{ConvElecEE}} + \text{IdleEnergy}_{\text{SteamElecEE}} + \text{PreHeatEnergy}_{\text{EEElec}}) * \\ &\quad \text{Days} * 3.412 / 1,000,000] \end{aligned}$$

$$\begin{aligned} \text{CookingEnergy}_{\text{ConvGasBase}} &= 200 * (250 / 0.49) * 0.50 \\ &= 51,020 \text{ Btu} \end{aligned}$$

$$\begin{aligned} \text{CookingEnergy}_{\text{SteamGasBase}} &= 200 * (105 / 0.37) * (1 - 0.50) \\ &= 28,378 \text{ Btu} \end{aligned}$$

$$\begin{aligned} \text{IdleEnergy}_{\text{ConvGasBase}} &= 9,840 * ((12 - 200/125) * 0.50)) \\ &= 51,168 \text{ Btu} \end{aligned}$$

$$\begin{aligned} \text{IdleEnergy}_{\text{SteamGasBase}} &= 24,003 * ((12 - 200/195) * (1 - 0.50)) \\ &= 131,709 \text{ Btu} \end{aligned}$$

$$\text{PreHeatEnergy}_{\text{BaseGas}} = 10,964 \text{ Btu}$$

$$\begin{aligned} \text{CookingEnergy}_{\text{ConvElecEE}} &= 200 * (73.2 / 0.78) * 0.50 \\ &= 9,385 \text{ Wh} \end{aligned}$$

$$\begin{aligned} \text{CookingEnergy}_{\text{SteamElecEE}} &= 200 * (30.8 / 0.55) * (1 - 0.50) \\ &= 5,600 \text{ Wh} \end{aligned}$$

$$\begin{aligned} \text{IdleEnergy}_{\text{ConvElecEE}} &= 1,180 * ((12 - 200/119) * 0.50) \\ &= 6,088 \text{ Wh} \end{aligned}$$

$$\begin{aligned} \text{IdleEnergy}_{\text{SteamElecEE}} &= 1,970 * ((12 - 200/177) * (1 - 0.50))) \\ &= 10,707 \text{ Wh} \end{aligned}$$

$$\text{PreHeatEnergy}_{\text{EEElec}} = 997 \text{ Wh}$$

$$\begin{aligned} \text{SiteEnergySavings (MMBTUs)} &= [(51,020 + 28,378 + 51,168 + 131,709 + 10,964) * 365 / 1,000,000] \\ &\quad - [(9,385 + 5,600 + 6,088 + 10,707 + 997) * 365 * 3.412 / 1,000,000] \\ &= 58.9 \text{ MMBtu} \end{aligned}$$

$$\begin{aligned} \text{If supported by an electric utility;} \quad \Delta \text{kWh} &= \Delta \text{SiteEnergySavings} * 1,000,000 / 3,412 \\ &= 58.9 * 1,000,000 / 3,412 \\ &= 17,263 \text{ kWh} \end{aligned}$$

SUMMER COINCIDENT PEAK DEMAND SAVINGS

For non-fuel switch measures:

$$\begin{aligned} \Delta \text{kW} &= ((\Delta \text{CookingEnergy}_{\text{ConvElec}} + \Delta \text{CookingEnergy}_{\text{SteamElec}} + \Delta \text{IdleEnergy}_{\text{ConvElec}} + \\ &\quad \Delta \text{IdleEnergy}_{\text{SteamElec}} + \Delta \text{PreHeatEnergy}_{\text{Elec}}) / (1,000 * \text{HOURS}) * \text{CF} \end{aligned}$$

For fuel switch measures:

$$\Delta kW = - ((CookingEnergy_{ConvElecEE} + CookingEnergy_{SteamElecEE} + IdleEnergy_{ConvElecEE} + IdleEnergy_{SteamElecEE} + PreHeatEnergy_{EEElec}) / (1,000 * HOURS) * CF$$

Where:

$$CF = \text{Summer Peak Coincidence Factor for measure}$$

$$= 0.90^{191}$$

All other variables as defined above.

For example, a 10-pan capacity electric combination oven in a Full Service Limited Menu restaurant would save:

$$\begin{aligned} \Delta kW &= \Delta kWh / (1,000 * HOURS) * CF \\ &= (782 + 323 + 2,215 + 16,678 + 638) / (1,000 * 12) * 0.9 \\ &= 1.55 \text{ kW} \end{aligned}$$

FOSSIL FUEL SAVINGS

Calculation provided together with Electric Energy Savings above.

WATER IMPACT DESCRIPTIONS AND CALCULATION

N/A

DEEMED O&M COST ADJUSTMENT CALCULATION

N/A

COST EFFECTIVENESS SCREENING AND LOAD REDUCTION FORECASTING WHEN FUEL SWITCHING

This measure can involve fuel switching from fossil fuel to electric.

For the purposes of forecasting load reductions due to fuel switch projects per Section 16-111.5B, changes in site energy use at the customer’s meter (using ΔkWh algorithm below), customer switching estimates, NTG, and any other adjustment factors deemed appropriate, should be used.

The inputs to cost effectiveness screening should reflect the actual impacts on the electric and fuel consumption at the customer meter and, for fuel switching measures, should therefore reflect the decrease in one fuel and increase in another, as opposed to the single savings value calculated in the “Electric and Fossil Fuel Energy Savings” section above. Therefore in addition to the calculation of savings claimed, the following values should be used to assess the cost effectiveness of the measure.

$$\begin{aligned} \Delta \text{Therms} &= [\text{Gas Cooking Consumption Replaced}] \\ &= [(CookingEnergy_{ConvGasBase} + CookingEnergy_{SteamGasBase} + IdleEnergy_{ConvGasBase} + IdleEnergy_{SteamGasBase} + PreHeatEnergy_{BaseGas}) * \text{Days} / 100,000] \\ \Delta kWh &= [\text{Electric Cooking Consumption Added}] \\ &= - [(CookingEnergy_{ConvElecEE} + CookingEnergy_{SteamElecEE} + IdleEnergy_{ConvElecEE} + IdleEnergy_{SteamElecEE} + PreHeatEnergy_{EEElec}) * \text{Days} / 1,000] \end{aligned}$$

¹⁹¹ Itron, Inc. 2005. 2004-2005 Database for Energy Efficiency Resources (DEER) Update Study - Final Report. Prepared for Southern California Edison.

MEASURE CODE: CI-FSE-CBOV-V06-250101

REVIEW DEADLINE: 1/1/2028

4.2.2 Commercial Solid and Glass Door Refrigerators & Freezers

DESCRIPTION

This measure relates to the installation of a new reach-in commercial refrigerator or freezer meeting ENERGY STAR efficiency standards. ENERGY STAR labeled commercial refrigerators and freezers are more energy efficient because they are designed with components such as ECM evaporator and condenser fan motors, hot gas anti-sweat heaters, or high-efficiency compressors, which will significantly reduce energy consumption.

This measure was developed to be applicable to the following program types: TOS and NC. If applied to other program types, the measure savings should be verified.

DEFINITION OF EFFICIENT EQUIPMENT

In order for this characterization to apply, the efficient equipment is assumed to be a new ENERGY STAR certified vertical closed solid or glass door refrigerator or freezer meeting energy consumptions requirements as determined by door type (solid or glass) and refrigerated volume (V).

ENERGY STAR Requirements (Version 5.0, Effective December 22, 2022)

Volume (ft ³)	Maximum Daily Energy Consumption (kWh/day)	
	Refrigerator	Freezer
Vertical Closed		
Solid Door		
0 < V < 15	≤ 0.0267V + 0.8	≤ 0.21V + 0.9
15 ≤ V < 30	≤ 0.05V + 0.45	≤ 0.12V + 2.248
30 ≤ V < 50	≤ 0.05V + 0.45	≤ 0.2578V - 1.8864
V ≥ 50	≤ 0.025V + 1.6991	≤ 0.14V + 4.0
Glass Door		
0 < V < 15	≤ 0.095V + 0.445	≤ 0.232V + 2.36
15 ≤ V < 30	≤ 0.05V + 1.12	
30 ≤ V < 50	≤ 0.076V + 0.34	
V ≥ 50	≤ 0.105V - 1.111	

DEFINITION OF BASELINE EQUIPMENT

In order for this characterization to apply, the baseline equipment is assumed to be a new vertical closed solid or glass door refrigerator or freezer that is not ENERGY STAR certified.

DEEMED LIFETIME OF EFFICIENT EQUIPMENT

The expected measure life is assumed to be 12 years.¹⁹²

DEEMED MEASURE COST

The incremental capital cost for this measure is provided in the table below.¹⁹³

Door Type	Volume	Refrigerator	Freezer
Solid Door	0 < V < 15	\$53	\$27
	15 ≤ V < 30	\$121	\$57

¹⁹²2008 Database for Energy-Efficiency Resources (DEER), Version 2008.2.05, "Effective/Remaining Useful Life Values", California Public Utilities Commission, December 16, 2008.

¹⁹³Energy Star, 2021. ENERGY STAR Version 5.0 Commercial Refrigerators and Freezers Data Pack.xlsx. From Incremental Cost and Payback tab, an average \$/sq ft value was calculated and applied to the average volumes for each refrigerator and freezer category – rounded to the nearest dollar (from product data tabs, and 2023 Energy Star QPL)

Door Type	Volume	Refrigerator	Freezer
	$30 \leq V < 50$	\$247	\$119
	$50 \leq V$	\$401	\$196
Glass Door	$0 < V < 15$	\$51	\$19
	$15 \leq V < 30$	\$125	\$56
	$30 \leq V < 50$	\$252	\$114
	$50 \leq V$	\$420	\$201

LOADSHAPE

Loadshape C23 - Commercial Refrigeration

COINCIDENCE FACTOR

The summer peak coincidence factor for this measure is assumed to be 0.937.¹⁹⁴

Algorithm

CALCULATION OF SAVINGS

ELECTRIC ENERGY SAVINGS

$$\Delta kWh = (kWh_{base} - kWh_{ee}) * 365.25$$

Where:

kWh_{base} = baseline maximum daily energy consumption in kWh

= calculated using actual chilled or frozen compartment volume (V) of the efficient unit as shown in the table below.

Type	kWh_{base}^{195}
Solid Door Refrigerator	$0.05 * V + 1.36$
Glass Door Refrigerator	$0.1 * V + 0.86$
Solid Door Freezer	$0.22 * V + 1.38$
Glass Door Freezer	$0.29 * V + 2.95$

kWh_{ee}^{196} = efficient maximum daily energy consumption in kWh

= actual if known. If unknown can be calculated using actual chilled or frozen compartment volume (V) of the efficient unit as shown in the table below.

Volume (ft ³)	kWh _{ee}	
	Refrigerator	Freezer
Vertical Closed		
Solid Door		
$0 < V < 15$	$\leq 0.0267V + 0.8$	$\leq 0.21V + 0.9$
$15 \leq V < 30$	$\leq 0.05V + 0.45$	$\leq 0.12V + 2.248$
$30 \leq V < 50$	$\leq 0.05V + 0.45$	$\leq 0.2578V - 1.8864$

¹⁹⁴ The CF for Commercial Refrigeration was calculated based upon the Ameren provided eShapes

¹⁹⁵Federal standards for equipment manufactured on or after March 27, 2017: 10 CFR §431.66 - Energy Conservation Standards for Commercial Refrigerators, Freezers and Refrigerator-Freezers.

¹⁹⁶ENERGY STAR Program Requirements for Commercial Refrigerators and Freezers Partner Commitments Version 5.0, effective December 22, 2022

Volume (ft ³)	kW _h	
	Refrigerator	Freezer
V ≥ 50	≤ 0.025V + 1.6991	≤ 0.14V + 4.0
Glass Door		
0 < V < 15	≤ 0.095V + 0.445	≤ 0.232V + 2.36
15 ≤ V < 30	≤ 0.05V + 1.12	
30 ≤ V < 50	≤ 0.076V + 0.34	
V ≥ 50	≤ 0.105V - 1.111	

V = the chilled or frozen compartment volume (ft³) (as defined in the Association of Home Appliance Manufacturers Standard HRF1–1979)

= Actual installed

365.25 = days per year

For example, a solid door refrigerator with a volume of 15 would save

$$\Delta kWh = (2.11 - 1.20) * 365.25$$

$$= 332 \text{ kWh}$$

SUMMER COINCIDENT PEAK DEMAND SAVINGS

$$\Delta kW = \Delta kWh / \text{HOURS} * CF$$

Where:

HOURS = equipment is assumed to operate continuously, 24 hours per day, 365.25 days per year.
= 8766

CF = Summer Peak Coincidence Factor for measure
= 0.937

For example, a solid door refrigerator with a volume of 15 would save

$$\Delta kW = 332 / 8766 * .937$$

$$= 0.0355 \text{ kW}$$

FOSSIL FUEL SAVINGS

N/A

WATER IMPACT DESCRIPTIONS AND CALCULATION

N/A

DEEMED O&M COST ADJUSTMENT CALCULATION

N/A

MEASURE CODE: CI-FSE-CSDO-V03-240101

REVIEW DEADLINE: 1/1/2028

4.2.3 Commercial Steam Cooker

DESCRIPTION

To qualify for this measure the installed equipment must be an ENERGY STAR® steamer in place of a standard steamer in a commercial kitchen. Savings are presented dependent on the pan capacity and corresponding idle rate at heavy load cooking capacity and if the steamer is gas or electric.

This measure was developed to be applicable to the following program types: TOS. If applied to other program types, the measure savings should be verified.

DEFINITION OF EFFICIENT EQUIPMENT

To qualify for this measure the installed equipment must be as follows:

Gas	Electric
ENERGY STAR® qualified with 38% minimum cooking energy efficiency at heavy load (potato) cooking capacity for gas steam cookers.	ENERGY STAR® qualified with 50% minimum cooking energy efficiency at heavy load (potato) cooking capacity for electric steam cookers.

DEFINITION OF BASELINE EQUIPMENT

The baseline condition is assumed to be a non-ENERGY STAR® commercial steamer at end of life. It is assumed that the efficient equipment and baseline equipment have the same number of pans.

DEEMED LIFETIME OF EFFICIENT EQUIPMENT

The expected measure life is assumed to be 12 years.¹⁹⁷

DEEMED MEASURE COST

The incremental capital cost for this measure uses actual costs, otherwise use costs outlined below:¹⁹⁸

Equipment Type	Baseline Equipment Cost	Efficient Equipment Cost	Incremental Cost
Electric	\$5,444	\$8,201	\$2,758
Gas	\$10,265	\$12,324	\$2,059

LOADSHAPE

Loadshape C01 - Commercial Electric Cooking

COINCIDENCE FACTOR

Summer Peak Coincidence Factor for measure is provided below for different building types:¹⁹⁹

Location	CF
Fast Food Limited Menu	0.32
Fast Food Expanded Menu	0.41
Pizza	0.46
Full Service Limited Menu	0.51
Full Service Expanded Menu	0.36
Cafeteria	0.39

¹⁹⁷California DEER 2008 which is also used by both the Food Service Technology Center and ENERGY STAR®.

¹⁹⁸ Costs taken from California "SWFS005-03_Steamers_2022_Price_Updated"

¹⁹⁹ Values taken from Minnesota Technical Reference Manual (Version 2.2, effective May 2, 2018), 'Electric Oven and Range' measure and are based upon "Project on Restaurant Energy Performance-End-Use Monitoring and Analysis", Appendixes I and II, Claar, et. al., May 1985. Unknown is an average of other location types

Location	CF
Unknown	0.408

:

Algorithm

CALCULATION OF SAVINGS

Formulas below are applicable to both gas and electric steam cookers. Please use appropriate lookup values and identified flags.

ENERGY SAVINGS AND FOSSIL FUEL SAVINGS

Non-Fuel Switch Measures

The algorithm below applies to ENERGY STAR electric steam cooker compared to baseline electric steam cooker:

$$\Delta kWh = (\Delta Idle Energy + \Delta Preheat Energy + \Delta Cooking Energy) * Days$$

The algorithm below applies to ENERGY STAR gas steam cooker compared to baseline gas steam cooker:

$$\Delta Therms = (\Delta Idle Energy + \Delta Preheat Energy + \Delta Cooking Energy) * 1/100,000 * Days$$

Fuel Switch/Electrification Measures

Fuel switch / electrification measures must produce positive total energy savings (i.e., reduction in Btus at the premises) in order to qualify. This is determined as follows:

$$\begin{aligned} \text{SiteEnergySavings (MMBTUs)} &= [\text{GasConsumptionReplaced}] - [\text{ElectricConsumptionAdded}] \\ &= [(\text{Idle Energy}_{\text{GasBase}} + \text{Preheat Energy}_{\text{GasBase}} + \text{Cooking Energy}_{\text{GasBase}}) * \\ &\quad 1/1,000,000 * \text{Days}] - \\ &\quad [(\text{Idle Energy}_{\text{ElecEE}} + \text{Preheat Energy}_{\text{ElecEE}} + \text{Cooking Energy}_{\text{ElecEE}}) * \\ &\quad 3,412/1,000,000 * \text{Days}] \end{aligned}$$

If SiteEnergySavings calculated above is positive, the measure is eligible.

The appropriate savings claim is dependent on which utilities are supporting the measure as provided in a table below:

Measure Supported By:	Electric Utility Claims (kWh):	Gas Utility Claims (therms):
Electric utility only	SiteEnergySavings * 1,000,000/3,412	N/A
Electric and gas utility (Note utilities may make alternative agreements to how savings are allocated as long as total MMBtu savings remains the same).	%IncentiveElectric * SiteEnergySavings * 1,000,000/3,412	%IncentiveGas * SiteEnergySavings * 10
Gas utility only	N/A	SiteEnergySavings * 10

Where:

$$\Delta Idle Energy = (((1 - CSM\%_{\text{Baseline}}) * IDLE_{\text{BASE}} + CSM\%_{\text{Baseline}} * PC_{\text{BASE}} * E_{\text{FOOD}} / EFF_{\text{BASE}}) * (\text{HOURS}_{\text{day}} - (F / PC_{\text{Base}}) - (PRE_{\text{number}} * PRE_{\text{TimeBase}} / 60))) - (((1 - CSM\%_{\text{ENERGYSTAR}}) * IDLE_{\text{ENERGYSTAR}} +$$

$$CSM\%ENERGYSTAR * PCENERGYSTAR * E_{FOOD} / EFFENERGYSTAR * (HOURS_{Day} - (F / PCENERGYSTAR) - (PRE_{number} * PRE_{TimeEE} / 60)))$$

$$\Delta Preheat Energy = (PRE_{number} * (PRE_{heatEnergyBase} - PRE_{heatEnergyEE}))$$

$$\Delta Cooking Energy = ((1/ EFF_{BASE}) - (1/ EFF_{ENERGY STAR})) * F * E_{FOOD}$$

$$Idle Energy_{GasBase} = (((1- CSM\%Baseline) * IDLE_{BASE} + CSM\%Baseline * PC_{BASE} * E_{FOOD} / EFF_{BASE}) * (HOURS_{day} - (F / PC_{Base}) - (PRE_{number} * PRE_{TimeGasBase} / 60)))$$

$$Preheat Energy_{GasBase} = (PRE_{number} * Pre_{heatEnergyGasBase})$$

$$Cooking Energy_{GasBase} = (1/ EFF_{BASE}) * F * E_{FOOD}$$

$$Idle Energy_{ElecEE} = (((1- CSM\%ENERGYSTAR) * IDLE_{ENERGYSTAR} + CSM\%ENERGYSTAR * PC_{ENERGY} * E_{FOOD} / EFF_{ENERGYSTAR}) * (HOURS_{Day} - (F / PC_{ENERGYSTAR}) - (PRE_{number} * PRE_{TimeElecEE} / 60)))$$

$$Preheat Energy_{ElecEE} = (PRE_{number} * Pre_{heatEnergyElecEE})$$

$$Cooking Energy_{ElecEE} = (1/ EFF_{ENERGY STAR}) * F * E_{FOOD}$$

Where:

$CSM\%_{Baseline}$ = Baseline Steamer Time in Manual Steam Mode (% of time)
 = 90%²⁰⁰

$IDLE_{Base}$ = Idle Energy Rate of Base Steamer²⁰¹

Number of Pans	IDLE _{BASE} - Gas, Btu/hr	IDLE _{BASE} - Electric, kw
3	11,000	1.0
4	14,667	1.33
5	18,333	1.67
6	22,000	2.0
10	18,000	1.2

PC_{Base} = Production Capacity of Base Steamer²⁰²

Number of Pans	PC _{BASE} , gas (lbs/hr)	PC _{BASE} , electric (lbs/hr)
3	65	70
4	87	93
5	108	117
6	130	140
10	233	233

E_{FOOD} = Amount of Energy Absorbed by the food during cooking known as ASTM Energy to Food (Btu/lb or kW/lb)

²⁰⁰Food Service Technology Center 2011 Savings Calculator

²⁰¹Food Service Technology Center 2011 Savings Calculator. Estimates for units with 10 pans taken from ENERGY STAR Commercial Food Service Savings Calculator.

²⁰²Production capacity per Food Service Technology Center 2011 Savings Calculator of 23.3333 lb/hr per pan for electric baseline steam cookers and 21.6667 lb/hr per pan for natural gas baseline steam cookers. ENERGY STAR® savings calculator uses 23.3 lb/hr per pan for both electric and natural gas baseline steamers. Estimates for units with 10 pans taken from ENERGY STAR Commercial Food Service Savings Calculator.

EFF_{BASE} =105 Btu/lb (gas steamers) or 0.0308 (electric steamers)²⁰³
 =Heavy Load Cooking Efficiency for Base Steamer
 =15% (gas steamers) or 26% (electric steamers)²⁰⁴

$\text{HOURS}_{\text{day}}$ = Average Daily Operation (hours)

Type of Food Service	$\text{HOURS}_{\text{day}}$ ²⁰⁵
Fast Food, limited menu	4
Fast Food, expanded menu	5
Pizza	8
Full Service, limited menu	8
Full Service, expanded menu	7
Cafeteria	6
Unknown	6 ²⁰⁶
Custom	Varies

F = Food cooked per day (lbs/day)
 = custom or if unknown, use 100 lbs/day²⁰⁷

$\text{CSM}_{\% \text{ENERGYSTAR}}$ = ENERGY STAR Steamer's Time in Manual Steam Mode (% of time)²⁰⁸
 = 0%

$\text{IDLE}_{\text{ENERGYSTAR}}$ = Idle Energy Rate of ENERGY STAR^{®209}
 =Actual, or

Number of Pans	$\text{IDLE}_{\text{ENERGY STAR}} - \text{gas, (Btu/hr)}$	$\text{IDLE}_{\text{ENERGY STAR}} - \text{electric, (kW)}$
3	6,250	0.40
4	8,333	0.53
5	10,417	0.67
6	12,500	0.80
10	12,500	0.80

$\text{PC}_{\text{ENERGYSTAR}}$ = Production Capacity of ENERGY STAR[®] Steamer²¹⁰

²⁰³ENERGY STAR Commercial Kitchen Equipment Savings Calculator, Steam Cooker Calculations

²⁰⁴Reference Food Service Technology Center 2011 Savings Calculator values as used by Consortium for Energy Efficiency, Inc. for baseline electric and natural gas steamer heavy cooking load energy efficiencies.

²⁰⁵ Values taken from Minnesota Technical Reference Manual (Version 2.2, effective May 2, 2018), ‘Electric Oven and Range’ measure and are based upon “Project on Restaurant Energy Performance-End-Use Monitoring and Analysis”, Appendixes I and II, Claar, et. al., May 1985.

²⁰⁶Unknown is average of other locations

²⁰⁷Reference amount used by both Food Service Technology Center and ENERGY STAR[®] savings calculator

²⁰⁸Reference information from the Food Service Technology Center siting that ENERGY STAR[®] steamers are not typically operated in constant steam mode, but rather are used in timed mode. Reference ENERGY STAR Commercial Kitchen Equipment Savings Calculator, Steam Cooker Calculation. Both baseline & efficient steamer mode values should be considered for users in Illinois market.

²⁰⁹Food Service Technology Center 2011 Savings Calculator. Estimates for units with 10 pans taken from ENERGY STAR Commercial Food Service Savings Calculator.

²¹⁰Production capacity per Food Service Technology Center 2011 Savings Calculator of 18.3333 lb/hr per pan for gas ENERGY STAR[®] steam cookers and 16.6667 lb/hr per pan for electric ENERGY STAR[®] steam cookers. ENERGY STAR[®] savings calculator

=Actual, or

Number of Pans	PC _{ENERGY - gas} (lbs/hr)	PC _{ENERGY - electric} (lbs/hr)
3	55	50
4	73	67
5	92	83
6	110	100
10	200	167

EFF_{ENERGYSTAR} = Heavy Load Cooking Efficiency for ENERGY STAR® Steamer(%)
 =Actual, or 38% (gas steamer) or 50% (electric steamer)²¹¹

PRE_{number} = Number of preheats per day
 =1²¹² (if unknown, use 1)

PRE_{heatEnergyBase} = Energy per preheat of Base Steamer²¹³

Equipment Type	Preheat Energy
Electric	1.78 kWh
Gas	18,832.7 Btu

PRE_{heatEnergyEE} = Energy per preheat of ENERGY STAR Steamer²¹⁴

Equipment Type	Preheat Energy
Electric	1.67 kWh
Gas	10,293.9 Btu

PRE_{TimeBase} =Preheat duration of Base Steamer²¹⁵

Equipment Type	Preheat Time (minutes)
Electric	11.9
Gas	10.9

PRE_{TimeEE} = Preheat duration of ENERGY STAR Steamer²¹⁶

Equipment Type	Preheat Time (minutes)
Electric	13.2
Gas	13.4

uses 16.7 lb/hr per pan for electric and 20 lb/hr for natural gas ENERGY STAR® steamers. Estimates for units with 10 pans taken from ENERGY STAR Commercial Food Service Savings Calculator.

²¹¹Reference Food Service Technology Center 2011 Savings Calculator values as used by Consortium for Energy Efficiency, Inc. for Tier 1A and Tier 1B qualified electric and natural gas steamer heavy cooking load energy efficiencies, as sourced from ENERGY STAR Program Requirements Product Specification for Commercial Steam Cookers, version 1.2, effective August 1, 2013.

²¹²Reference ENERGY STAR Commercial Kitchen Equipment Savings Calculator, Steam Cooker Calculations

²¹³ Reference ENERGY STAR Commercial Foodservice Savings Calculator, March 2021

²¹⁴ Ibid

²¹⁵ Ibid

²¹⁶ Ibid

- EFF_{BASE} =Heavy Load Cooking Efficiency for Base Steamer
 =15% (gas steamer) or 26% (electric steamer) ²¹⁷
- EFF_{ENERGYSTAR} =Heavy Load Cooking Efficiency for ENERGY STAR® Steamer
 =Actual, or 38% (gas steamer) or 50% (electric steamer) ²¹⁸
- F = Food cooked per day (lbs/day)
 = custom or if unknown, use 100 lbs/day²¹⁹
- E_{FOOD} = Amount of Energy Absorbed by the food during cooking known as ASTM Energy to Food²²⁰

E _{FOOD} - gas(Btu/lb)	E _{FOOD} (kWh/lb)
105 ²²¹	0.0308 ²²²

Days = days/yr steamer operating (use 365.25 days/yr if heavy use restaurant and exact number unknown)

²¹⁷ Reference Food Service Technology Center 2011 Savings Calculator values as used by Consortium for Energy Efficiency, Inc. for baseline electric and natural gas steamer heavy cooking load energy efficiencies.

²¹⁸ Ibid.

²¹⁹ Amount used by both Food Service Technology Center and ENERGY STAR® savings calculator

²²⁰ Reference ENERGY STAR Commercial Kitchen Equipment Savings Calculator, Steam Cooker Calculations.

²²¹ Ibid.

²²² Ibid.

For example, for an ENERGY STAR gas steam cooker compared to baseline gas cooker: A 3 pan steamer in a full service restaurant

$$\begin{aligned} \Delta\text{Savings} &= (\Delta\text{Idle Energy} + \Delta\text{Preheat Energy} + \Delta\text{Cooking Energy}) * \text{Days} * 1/100,000 \\ \Delta\text{Idle Energy} &= (((1- 0.9) * 11,000 + 0.9 * 65 * 105 /0.15)*(7 - (100 / 65)-(1*10.9/60))) - (((1-0) * 6250 + 0 * 55 * 105 / 0.38) * (7 - (100 / 55) - (1*13.4/60))) \\ &= 191,028 \text{ BTU/day} \\ \Delta\text{Preheat Energy} &= (1 *(18,832.7-10,293.9)) \\ &= 8,539 \text{ BTU/day} \\ \Delta\text{Cooking Energy} &= (((1/ 0.15) - (1/ 0.38)) * (100 \text{ lb/day} * 105 \text{ btu/lb})) \\ &= 42,368 \text{ BTU/day} \\ \Delta\text{Therms} &= (191,028 + 8,539 + 42,368) * 365.25 *1/100,000 \\ &= 884 \text{ therms} \end{aligned}$$

For an ENERGY STAR electric steam cooker compared to baseline electric cooker: A 3 pan steamer in a cafeteria:

$$\begin{aligned} \Delta\text{Savings} &= (\Delta\text{Idle Energy} + \Delta\text{Preheat Energy} + \Delta\text{Cooking Energy}) * \text{Days} \\ \Delta\text{Idle Energy} &= (((1- .9)* 1.0 + .9 * 70 * 0.0308 /0.26)*(6 - (100 / 70)-(1*11.9/60))) - (((1-0) * 0.4 + 0 * 50 * 0.0308 / 0.50) * (6 - (100 / 50) - (1*13.2/60))) \\ &= 31.6 \text{ kWh/day} \\ \Delta\text{Preheat Energy} &= (1 *(1.78 - 1.67)) \\ &= 0.1 \text{ kWh/day} \\ \Delta\text{Cooking Energy} &= (((1/ 0.26) - (1/ 0.5)) * (100 * 0.0308))) \\ &= 5.7 \text{ kWh/day} \\ \Delta\text{kWh} &= (31.6 + 0.1 + 5.7) * 365.25 \text{ days} \\ &= 13,660 \text{ kWh} \end{aligned}$$

For an ENERGY STAR electric steam cooker compared to baseline gas cooker: A 3 pan steamer in a cafeteria:

$$\begin{aligned} \text{SiteEnergySavings (MMBTUs)} &= [\text{GasConsumptionReplaced}] - [\text{ElectricConsumptionAdded}] \\ &= [(\text{Idle Energy}_{\text{GasBase}} + \text{Preheat Energy}_{\text{GasBase}} + \text{Cooking Energy}_{\text{GasBase}}) \\ &\quad * 1/1,000,000 * \text{Days}] - \\ &\quad [(\text{Idle Energy}_{\text{ElecEE}} + \text{Preheat Energy}_{\text{ElecEE}} + \text{Cooking Energy}_{\text{ElecEE}}) * \\ &\quad 3412/1,000,000 * \text{Days}] \end{aligned}$$

$$\begin{aligned} \text{Idle Energy}_{\text{GasBase}} &= (((1- 0.9) * 11000 + 0.9 * 65 * 105 / 0.15) * (6 - (100 / 65) - (1 * 10.9 / 60))) \\ &= 187,432 \text{ Btu} \end{aligned}$$

$$\begin{aligned} \text{Preheat Energy}_{\text{GasBase}} &= (1 * 18,832) \\ &= 18,832 \text{ BTU/day} \end{aligned}$$

$$\begin{aligned} \text{Cooking Energy}_{\text{GasBase}} &= (1 / 0.15) * (100 \text{ lb/day} * 105 \text{ btu/lb}) \\ &= 70,000 \text{ BTU/day} \end{aligned}$$

$$\begin{aligned} \text{Idle Energy}_{\text{ElecEE}} &= (((1-0) * 0.4 + 0 * 50 * 0.0308 / 0.50) * (6 - (100 / 50) - (1 * 13.2 / 60))) \\ &= 1.5 \text{ kWh/day} \end{aligned}$$

$$\begin{aligned} \text{Preheat Energy}_{\text{ElecEE}} &= (1 * 1.67) \\ &= 1.67 \text{ kWh/day} \end{aligned}$$

$$\begin{aligned} \text{Cooking Energy}_{\text{ElecEE}} &= (1 / 0.5) * (100 * 0.0308) \\ &= 6.16 \text{ kWh/day} \end{aligned}$$

$$\begin{aligned} \text{SiteEnergySavings (MMBTUs)} &= [(187,432 + 18,832 + 70,000) * 1/1,000,000 * 365.25] - \\ &= [(1.5 + 1.67 + 6.16) * 3,412/1,000,000 * 365.25] \\ &= 89.3 \text{ MMBtu} \end{aligned}$$

$$\begin{aligned} \text{If supported by an electric utility: } \Delta \text{kWh} &= \Delta \text{SiteEnergySavings} * 1,000,000 / 3,412 \\ &= 89.3 * 1,000,000 / 3,412 \\ &= 26,172 \text{ kWh} \end{aligned}$$

Secondary kWh Savings for Water Supply and Wastewater Treatment

The following savings should be included in the total savings for this measure, but should not be included in TRC tests to avoid double counting the economic benefit of water savings.

$$\Delta \text{kWh}_{\text{water}} = \Delta \text{Water (gallons)} / 1,000,000 * E_{\text{water supply}}$$

Where

$$\begin{aligned} E_{\text{water supply}} &= \text{IL Supply Energy Factor (kWh/Million Gallons)} \\ &= 2,571^{223} \end{aligned}$$

²²³ This factor include 2571 kWh/MG for water supply based on Illinois energy intensity data from a 2012 ISAWWA study. For more information please review Elevate Energy’s ‘IL TRM: Energy per Gallon Factor, May 2018 paper’. Note that the Commercial Steam Cooker does not discharge its water into the wastewater system so only the water supply factor is used here.

For example, an electric 3 pan steamer with average efficiency in a full service – expanded menu restaurant

$$\begin{aligned} \Delta\text{Water (gallons)} &= (40 - 10) * 7 * 365.25 \\ &= 76,703 \text{ gallons} \\ \Delta\text{kWh}_{\text{water}} &= 76,703/1,000,000*2,571 \\ &= 197 \text{ kWh} \end{aligned}$$

SUMMER COINCIDENT PEAK DEMAND SAVINGS

This is only applicable to the electric steam cooker.

Non-fuel switch measures:

$$\Delta\text{kW} = ((\Delta\text{Idle Energy} + \Delta\text{Preheat Energy} + \Delta\text{Cooking Energy}) / \text{HOURS}_{\text{Day}}) * \text{CF}$$

$$\Delta\text{kW} = - ((\text{Idle Energy}_{\text{ElecEE}} + \text{Preheat Energy}_{\text{ElecEE}} + \text{Cooking Energy}_{\text{ElecEE}}) / \text{HOURS}_{\text{Day}}) * \text{CF}$$

Where:

CF =Summer Peak Coincidence Factor for measure is provided below for different locations:²²⁴

Location	CF
Fast Food Limited Menu	0.32
Fast Food Expanded Menu	0.41
Pizza	0.46
Full Service Limited Menu	0.51
Full Service Expanded Menu	0.36
Cafeteria	0.39
Unknown	0.408

Other values as defined above

For example, for 3 pan electric steam cooker located in a cafeteria:

$$\begin{aligned} \Delta\text{kW} &= ((\Delta\text{Idle Energy} + \Delta\text{Preheat Energy} + \Delta\text{Cooking Energy}) / (\text{HOURS}_{\text{Day}} * \text{Days})) * \text{CF} \\ &= ((31.18 + 0.5 + 5.69)/6) * 0.39 \\ &= 2.43 \text{ kW} \end{aligned}$$

FOSSIL FUEL SAVINGS

Calculation provided together with Electric Energy Savings above.

WATER IMPACT DESCRIPTIONS AND CALCULATION

This is applicable to both gas and electric steam cookers.

$$\Delta\text{Water (gallons)} = (W_{\text{BASE}} - W_{\text{ENERGYSTAR}}) * \text{HOURS}_{\text{Day}} * \text{Days}$$

²²⁴Values taken from Minnesota Technical Reference Manual (Version 2.2, effective May 2, 2018), ‘Electric Oven and Range’ measure and are based upon “Project on Restaurant Energy Performance-End-Use Monitoring and Analysis”, Appendixes I and II, Claar, et. al., May 1985.

Where

W_{BASE} = Water Consumption Rate of Base Steamer (gal/hr)
 = 40²²⁵

$W_{ENERGYSTAR}$ = Water Consumption Rate of ENERGY STAR® Steamer look up²²⁶
 =Actual, or

Equipment Type	gal/hr
Boilerless	1.69
Steam Generation	6.6

For example, a boilerless electric 3 pan steamer with in a full service restaurant

$$\Delta Water \text{ (gallons)} = (40 - 1.69) * 7 * 365.25$$

$$= 97,949 \text{ gallons}$$

DEEMED O&M COST ADJUSTMENT CALCULATION

N/A

COST EFFECTIVENESS SCREENING AND LOAD REDUCTION FORECASTING WHEN FUEL SWITCHING

This measure can involve fuel switching from fossil fuel to electric.

For the purposes of forecasting load reductions due to fuel switch projects per Section 16-111.5B, changes in site energy use at the customer’s meter (using ΔkWh algorithm below), customer switching estimates, NTG, and any other adjustment factors deemed appropriate, should be used.

The inputs to cost effectiveness screening should reflect the actual impacts on the electric and fuel consumption at the customer meter and, for fuel switching measures, should therefore reflect the decrease in one fuel and increase in another, as opposed to the single savings value calculated in the “Electric and Fossil Fuel Energy Savings” section above. Therefore in addition to the calculation of savings claimed, the following values should be used to assess the cost effectiveness of the measure.

$$\Delta Therms = [\text{Gas Cooking Consumption Replaced}]$$

$$= [(\text{Idle Energy}_{GasBase} + \text{Preheat Energy}_{GasBase} + \text{Cooking Energy}_{GasBase}) * 1/100,000 * \text{Days}]$$

$$\Delta kWh = [\text{Electric Cooking Consumption Added}]$$

$$= - [(\text{Idle Energy}_{ElecEE} + \text{Preheat Energy}_{ElecEE} + \text{Cooking Energy}_{ElecEE}) * \text{Days}]$$

MEASURE CODE: CI-FSE-STMC-V09-250101

REVIEW DEADLINE: 1/1/2028

²²⁵ FSTC (2002). Commercial Cooking Appliance Technology Assessment. Chapter 8: Steamers.

²²⁶ Average water consumption by equipment type calculated from the ENERGY STAR Qualified Products List, Accessed 06/02/2023.

4.2.4 Conveyor Oven

DESCRIPTION

This measure applies to natural gas fired high efficiency conveyor ovens installed in commercial kitchens replacing existing natural gas units with conveyor width greater than 25 inches.

Conveyor ovens are available using four different heating processes: infrared, natural convection with a ceramic baking hearth, forced convection or air impingement, or a combination of infrared and forced convection. Conveyor ovens are typically used for producing a limited number of products with similar cooking requirements at high production rates. They are highly flexible and can be used to bake or roast a wide variety of products including pizza, casseroles, meats, breads, and pastries.

Some manufacturers offer an air-curtain feature at either end of the cooking chamber that helps to keep the heated air inside the conveyor oven. The air curtain operates as a virtual oven wall and helps reduce both the idle energy of the oven and the resultant heat gain to the kitchen.

This measure was developed to be applicable to the following program types: TOS. If applied to other program types, the measure savings should be verified.

DEFINITION OF EFFICIENT EQUIPMENT

To qualify for this measure the installed equipment must be a natural gas conveyor oven with a tested baking energy efficiency > 42% and an idle energy consumption rate < 57,000 Btu/hr utilizing ASTM standard F1817.

DEFINITION OF BASELINE EQUIPMENT

The baseline equipment is an existing pizza deck oven at end of life.

DEEMED LIFETIME OF EFFICIENT EQUIPMENT

The expected measure life is assumed to be 12 years.²²⁷

DEEMED MEASURE COST

The incremental capital cost for this measure is \$2230.²²⁸

LOADSHAPE

N/A

COINCIDENCE FACTOR

N/A

Algorithm

CALCULATION OF SAVINGS

ELECTRIC ENERGY SAVINGS

N/A

SUMMER COINCIDENT PEAK DEMAND SAVINGS

N/A

²²⁷See PG&E Workpaper PGECOFST117 Commercial Conveyor Oven – Gas Revision #6, published April 1, 2016.

²²⁸Ibid.

FOSSIL FUEL SAVINGS²²⁹

$$\Delta\text{Therms} = ((\Delta\text{DailyPreheatEnergy} + \Delta\text{DailyIdleEnergy} + \Delta\text{DailyCookingEnergy}) * \text{Days}) / 100,000$$

Where:

- ΔTherms = Annual therms calculated as in the equation above
- Days = Annual days of kitchen operation
=Actual, if unknown assume 365.25

$$\Delta\text{DailyPreheatEnergy} = (\text{PreheatEnergy}_{\text{Base}} * \text{Preheats}) - (\text{PreheatEnergy}_{\text{EE}} * \text{Preheats})$$

Where:

- $\Delta\text{DailyPreheatEnergy}$ = Energy savings per day when gas conveyor oven is preheating calculated as in the equation above
- $\text{PreheatEnergy}_{\text{Base}}$ = Preheat energy of baseline gas conveyor oven
= Actual, if unknown use 35,000 Btu
- $\text{PreheatEnergy}_{\text{EE}}$ = Preheat energy of efficient conveyor oven
= Actual, if unknown use 18,000 Btu
- Preheats = Number of preheats per day
= Actual, if unknown use 1

$$\Delta\text{DailyIdleEnergy} = (\text{IdleRateGas}_{\text{Base}} * (\text{Hours} - \text{FoodCooked} / \text{ProductionGas}_{\text{Base}} - (\text{Preheats} * \text{PreheatTime} / 60)) - (\text{IdleRateGas}_{\text{EE}} * (\text{Hours} - \text{FoodCooked} / \text{ProductionGas}_{\text{EE}} - (\text{Preheats} * \text{PreheatTime} / 60)))$$

Where:

- $\Delta\text{DailyIdleEnergy}$ = Energy savings per day when gas conveyor oven is idle as calculated in the equation above
- Hours = Average daily hours of operation
=Actual, if unknown assume 12 hours
- $\text{IdleRateGas}_{\text{Base}}$ = Idle energy rate of baseline gas conveyor oven
=Actual, if unknown use 70,000 Btu/hr
- $\text{IdleRateGas}_{\text{EE}}$ = Idle energy rate of efficient gas conveyor oven
=Actual, if unknown use 57,000 Btu/hr
- FoodCooked = Food cooked per day
= Actual, if unknown use 250 pizzas
- Preheats = Number of preheats per day
= Actual, if unknown use 1

²²⁹ All inputs are taken from PG&E Workpaper PGECOFST117 Commercial Conveyor Oven – Gas Revision #6, published April 1, 2016, unless otherwise referenced.

- PreheatTime = Length of one preheat
= Actual, if unknown use 15 minutes
- ProductionGas_{Base} = Production capacity of baseline gas conveyor oven
= 150 pizzas per hour
- ProductionGas_{EE} = Production capacity of efficient gas conveyor oven
= Actual, if unknown use 220 pizzas per hour

$$\Delta\text{DailyCookingEnergy} = (\text{FoodCooked} * \text{EFOOD}_{\text{Gas}}/\text{EFF}_{\text{Base}}) - (\text{FoodCooked} * \text{EFOOD}_{\text{Gas}}/\text{EFF}_{\text{EE}})$$

Where:

- $\Delta\text{DailyCookingEnergy}$ = Energy savings per day when gas conveyor oven is cooking
- FoodCooked = Food cooked per day
= Actual, if unknown use 250 pizzas
- $\text{EFOOD}_{\text{Gas}}$ = ASTM energy to food for gas conveyor oven
= 190 Btu/pizza
- EFF_{Base} = Cooking efficiency of baseline conveyor oven
= Actual, if unknown use 20%
- EFF_{EE} = Cooking efficiency of efficient conveyor oven
= Actual, if unknown use 42%

For example, an efficient conveyor oven compared to baseline conveyor oven using default values from above would save.

$$\Delta\text{Therms} = ((\Delta\text{DailyPreheatEnergy} + \Delta\text{DailyIdleEnergy} + \Delta\text{DailyCookingEnergy}) * \text{Days}) / 100,000$$

Where:

$$\begin{aligned} \Delta\text{DailyPreheatEnergy} &= (35,000 * 1) - (18,000 * 1) \\ &= 17,000 \text{ btu} \\ \Delta\text{DailyIdleEnergy} &= (70,000 * (12 - 250 / 150 - (1 * 15 / 60))) - (57,000 * (12 - 250 / 220 - (1 * 15 / 60))) \\ &= 21,835 \text{ btu} \\ \Delta\text{DailyCookingEnergy} &= (250 * 190 / 0.2) - (250 * 190 / 0.42) \\ = 124,405 \text{ btu} \end{aligned}$$

$$\begin{aligned} \Delta\text{Therms} &= (17,000 + 21,835 + 124,405) * 365.25 / 100000 \\ &= 596 \text{ therms} \end{aligned}$$

WATER IMPACT DESCRIPTIONS AND CALCULATION

N/A

DEEMED O&M COST ADJUSTMENT CALCULATION

N/A

MEASURE CODE: CI-FSE-CVOV-V03-240101

REVIEW DEADLINE: 1/1/2028

4.2.5 ENERGY STAR Convection Oven

DESCRIPTION

This measure applies to electric or natural gas fired ENERGY STAR convection ovens installed in a commercial kitchen.

Commercial convection ovens that are ENERGY STAR certified have higher heavy load cooking efficiencies, and lower idle energy rates, making them up to 20 percent more efficient than standard models. Energy savings estimates are for ovens using full size (18" x 36") sheet pans.

This measure was developed to be applicable to the following program types: TOS. If applied to other program types, the measure savings should be verified.

DEFINITION OF EFFICIENT EQUIPMENT

To qualify for this measure the installed equipment must meet ENERGY STAR requirements listed in ENERGY STAR Commercial Ovens Specifications Version 3.0.

DEFINITION OF BASELINE EQUIPMENT

The baseline equipment is a convection oven that is not ENERGY STAR certified and is at end of life.

DEEMED LIFETIME OF EFFICIENT EQUIPMENT

The expected measure life is assumed to be 12 years.²³⁰

DEEMED MEASURE COST

The incremental capital cost for this measure uses actual costs, otherwise use costs outlined below:²³¹

Equipment Type	Baseline Equipment Cost	Efficient Equipment Cost	Incremental Cost
Electric	\$7,652	\$8,612	\$960
Gas	\$7,510	\$9,884	\$2,374

LOADSHAPE

Loadshape C01 - Commercial Electric Cooking

COINCIDENCE FACTOR

Summer Peak Coincidence Factor for measure is assumed to be 0.90.²³²

Algorithm

CALCULATION OF SAVINGS

ELECTRIC ENERGY AND FOSSIL FUEL SAVINGS

Non-Fuel Switch Measures

The algorithm below applies to ENERGY STAR compared to baseline electric convection ovens:

²³⁰ Lifetime from ENERGY STAR Commercial Kitchen Equipment Savings Calculator, Oven Calculations, which cites reference as "FSTC research on available models, 2009".

²³¹ Costs sourced from California SWFS001_Convection_Oven_IMC_Analysis_-_2022-07-25

²³² Itron, Inc. 2005. 2004-2005 Database for Energy Efficiency Resources (DEER) Update Study - Final Report. Prepared for Southern California Edison.

$$\Delta kWh = (\Delta DailyIdle Energy + \Delta DailyPreheat Energy + \Delta DailyCooking Energy) * Days$$

The algorithm below applies to ENERGY STAR compared to baseline gas convection ovens:

$$\Delta Therms = (\Delta DailyIdle Energy + \Delta DailyPreheat Energy + \Delta DailyCooking Energy) * Days / 100,000$$

Fuel Switch/Electrification Measures

Fuel switch / electrification measures must produce positive total energy savings (i.e., reduction in Btus at the premises) in order to qualify. This is determined as follows:

$$\begin{aligned} \text{SiteEnergySavings (MMBTUs)} &= [\text{GasConsumptionReplaced}] - [\text{ElectricConsumptionAdded}] \\ &= [(\text{DailyIdle Energy}_{\text{GasBase}} + \text{DailyPreheat Energy}_{\text{GasBase}} + \text{DailyCooking Energy}_{\text{GasBase}}) * 1/1,000,000 * \text{Days}] - \\ &\quad [(\text{DailyIdle Energy}_{\text{ElecEE}} + \text{DailyPreheat Energy}_{\text{ElecEE}} + \text{DailyCooking Energy}_{\text{ElecEE}}) * 3412/1,000,000 * \text{Days}] \end{aligned}$$

If SiteEnergySavings calculated above is positive, the measure is eligible.

The appropriate savings claim is dependent on which utilities are supporting the measure as provided in a table below:

Measure Supported By:	Electric Utility Claims (kWh):	Gas Utility Claims (therms):
Electric utility only	SiteEnergySavings * 1,000,000/3,412	N/A
Electric and gas utility (Note utilities may make alternative agreements to how savings are allocated as long as total MMBtu savings remains the same).	%IncentiveElectric * SiteEnergySavings * 1,000,000/3,412	%IncentiveGas * SiteEnergySavings * 10
Gas utility only	N/A	SiteEnergySavings * 10

$$\Delta DailyIdleEnergy = (\text{IdleBase} * \text{IdleBaseTime}) - (\text{IdleENERGYSTAR} * \text{IdleENERGYSTARTime})$$

$$\Delta DailyCookingEnergy = (\text{LB} * \text{EFOOD} / \text{Eff}_{\text{Base}}) - (\text{LB} * \text{EFOOD} / \text{Eff}_{\text{ENERGYSTAR}})$$

$$\Delta DailyPreheatEnergy = (\text{PreheatNumber} * \text{PreheatTimeBase} / 60 * \text{PreheatRateBase}) - (\text{PreheatNumber} * \text{PreheatTimeENERGYSTAR} / 60 * \text{PreheatRateENERGYSTAR})$$

$$\text{DailyIdle Energy}_{\text{GasBase}} = (\text{IdleBase}_{\text{Gas}} * \text{IdleBaseTime}_{\text{Gas}})$$

$$\text{DailyCooking Energy}_{\text{GasBase}} = (\text{LB} * \text{EFOOD} / \text{Eff}_{\text{BaseGas}})$$

$$\text{DailyIdle Energy}_{\text{ElecEE}} = (\text{IdleENERGYSTAR}_{\text{Elec}} * \text{IdleENERGYSTARTime})$$

$$\text{DailyCooking Energy}_{\text{ElecEE}} = (\text{LB} * \text{EFOOD} / \text{Eff}_{\text{ENERGYSTARElec}})$$

Where²³³:

²³³ All assumptions except where noted are based upon data package provided alongside ENERGY STAR Commercial Ovens Specifications Version 3.0. See ENERGY STAR v3 Commercial Ovens Data Package.xlsx.

IdleENERGYSTAR = Idle energy rate
 = Actual, if unknown assume:

Oven Type	IdleENERGYSTAR
Electric Half Size	0.8 kW/h
Electric Full-Size ≥ 5 pans	1.2 kW/h
Electric Full-Size < 5 pans	1.0 kW/h
Natural Gas	8,027 Btu/h

IdleBase = Idle energy rate

Oven Type	IdleBASE
Electric Half Size	1.51 kW/h
Electric Full-Size ≥ 5 pans	1.63 kW/h
Electric Full-Size < 5 pans	1.29 kW/h
Natural Gas	12,239 Btu/h

IdleENERGYSTARTime = ENERGY STAR Idle Time (hours)
 = $HOURS_{day} - LB / PC_{ENERGYSTAR} - PreHeatTime_{ENERGYSTAR} / 60$

Using defaults:

Oven Type	Calculation	IdleENERGYSTARTime
Electric Half Size	= $12 - 61/42 - 8/60$	10.4
Electric Full-Size ≥ 5 pans	= $12 - 122/98 - 9/60$	10.6
Electric Full-Size < 5 pans	= $12 - 122/65 - 9/60$	10.0
Natural Gas	= $12 - 100/90 - 11/60$	10.7

HOURSday = Average Daily Operation
 = custom or if unknown, use 12 hours

LB = Food cooked per day
 = custom or if unknown, use 100 pounds for gas oven, 61 lbs for half sized electric oven or 122 lbs for full-sized electric oven²³⁴. For fuel switching scenarios, use same LB assumption for both baseline and efficient.

PC_{ENERGYSTAR} = Production Capacity ENERGY STAR (lb/hr)
 = Actual, if unknown use:

Oven Type	PC _{ENERGYSTAR}
Electric Half Size	42
Electric Full-Size ≥ 5 pans	98
Electric Full-Size < 5 pans	65
Natural Gas	90

PreheatTime_{ENERGYSTAR} = preheat length of ENERGY STAR oven
 = custom or if unknown use²³⁵:

Oven Type	PreheatTime _{ENERGYSTAR}
Electric Half Size	8
Electric Full-Size	9

²³⁴ Gas default is based upon the ENERGY STAR Commercial Kitchen Calculator. Electric defaults based on data from the Regional Technical Forum for the Northwest Council (Commercial Cooking Convection Oven Calculator, UES Measure Workbook), see "ComCookingConvectionOven_v4_0.xlsm".

²³⁵ ENERGY STAR Commercial Kitchen Calculator, updated March 2021.

Natural Gas	11
-------------	----

IdleBaseTime = BASE Idle Time
 = $\text{HOURS}_{\text{day}} - \text{LB} / \text{PC}_{\text{base}} - \text{PreHeatTime}_{\text{Base}} / 60$
 Using defaults:

Oven Type	Calculation	IdleENERGYSTARTime
Electric Half Size	= $12 - 61/45 - 9/60$	10.5
Electric Full-Size ≥ 5 pans	= $12 - 122/102 - 9/60$	10.7
Electric Full-Size < 5 pans	= $12 - 122/76 - 9/60$	10.2
Natural Gas	= $12 - 100/93 - 12/60$	10.7

PC_{Base} = Production Capacity base
 = Actual, if unknown use:

Oven Type	PC _{Base}
Electric Half Size	45
Electric Full-Size ≥ 5 pans	102
Electric Full-Size < 5 pans	76
Natural Gas	93

PreheatTimeBase = preheat length of base oven
 = custom or if unknown use²³⁶:

Oven Type	PreheatTimeBase
Electric Half Size	9
Electric Full-Size	9
Natural Gas	12

Days = Annual days of operation
 = custom or if unknown, use 365.25 days a year

EFOOD = ASTM energy to food
 = 0.0732 kWh/lb for electric ovens or 250 btu/pound for natural gas ovens²³⁷:

Eff_{ENERGYSTAR} = Cooking Efficiency ENERGY STAR
 = Actual, if unknown use:

Oven Type	Eff _{ENERGYSTAR}
Electric Half Size	75%
Electric Full-Size ≥ 5 pans	80%
Electric Full-Size < 5 pans	81%
Natural Gas	52%

Eff_{Base} = Cooking Efficiency Baseline

²³⁶ ENERGY STAR Commercial Kitchen Calculator, updated March 2021.

²³⁷ ENERGY STAR Commercial Kitchen Calculator, updated March 2021.

Oven Type	Eff _{Base}
Electric Half Size	64%
Electric Full-Size ≥ 5 pans	74%
Electric Full-Size < 5 pans	76.5%
Natural Gas	47%

PreheatRate_{Base} =Preheat rate (kWh/day for electric units, btu/day for natural gas units) baseline.
 =Actual, if unknown

Oven Type	PreheatRate _{Base}
Electric Half Size	0.89
Electric Full-Size ≥ 5 pans	1.56
Electric Full-Size < 5 pans	1.56
Natural Gas	76,000

PreheatRate_{ENERGYSTAR} =Preheat rate (kWh/day for electric units, btu/day for natural gas units) ENERGY STAR.

=Actual; or if unknown

Oven Type	PreheatRate _{ENERGYSTAR}
Electric Half Size	0.70
Electric Full-Size ≥ 5 pans	1.39
Electric Full-Size < 5 pans	1.39
Natural Gas	44,000

PreheatNumber =Number of preheats per day
 = Actual; or if unknown use 1

For example, an ENERGY STAR gas oven compared to baseline gas oven using default values from above would save.

$$\Delta\text{Therms} = (\Delta\text{Idle Energy} + \Delta\text{Preheat Energy} + \Delta\text{Cooking Energy}) * \text{Days} / 100000$$

Where:

$$\begin{aligned} \Delta\text{DailyIdleEnergy} &= (12,239 * 10.7) - (8,027 * 10.7) \\ &= 45,068 \text{ btu} \end{aligned}$$

$$\begin{aligned} \Delta\text{DailyPreheatEnergy} &= (1 * 12 / 60 * 76,000) - (1 * 12 / 60 * 44,000) \\ &= 6,400 \text{ btu} \end{aligned}$$

$$\begin{aligned} \Delta\text{DailyCookingEnergy} &= (100 * 250 / 0.47) - (100 * 250 / 0.52) \\ &= 5,115 \text{ btu} \end{aligned}$$

$$\begin{aligned} \Delta\text{Therms} &= (45068 + 6,400 + 5115) * 365.25 / 100000 \\ &= 207 \text{ therms} \end{aligned}$$

An ENERGY STAR half sized electric oven compared to baseline electric oven using default values from above would save.

$$\Delta\text{kWh} = (\Delta\text{Idle Energy} + \Delta\text{DailyPreheat Energy} + \Delta\text{Cooking Energy}) * \text{Days} / 100000$$

Where:

$$\begin{aligned} \Delta\text{DailyIdleEnergy} &= (1.51 * 10.5) - (0.8 * 10.4) \\ &= 7.5 \text{ kWh} \end{aligned}$$

$$\begin{aligned} \Delta\text{DailyPreheatEnergy} &= (1 * 9 / 60 * 0.89) - (1 * 9 / 60 * 0.70) \\ &= 0.03 \text{ kWh} \end{aligned}$$

$$\begin{aligned} \Delta\text{DailyCookingEnergy} &= (61 * 0.0732 / 0.64) - (61 * 0.0732 / 0.75) \\ &= 1.02 \text{ kWh} \end{aligned}$$

$$\begin{aligned} \Delta\text{kWh} &= (7.5 + 0.03 + 1.02) * 365.25 \\ &= 3,123 \text{ kWh} \end{aligned}$$

An ENERGY STAR full sized electric oven \geq 5 pans compared to baseline electric oven using default values from above would save.

$$\Delta\text{kWh} = (\Delta\text{Idle Energy} + \Delta\text{DailyPreheat Energy} + \Delta\text{Cooking Energy}) * \text{Days} / 100000$$

Where:

$$\begin{aligned} \Delta\text{DailyIdleEnergy} &= (1.63 * 10.7) - (1.2 * 10.6) \\ &= 4.7 \text{ kWh} \end{aligned}$$

$$\begin{aligned} \Delta\text{DailyPreheatEnergy} &= (1 * 9 / 60 * 1.56) - (1 * 9 / 60 * 1.39) \\ &= 0.03 \text{ kWh} \end{aligned}$$

$$\begin{aligned} \Delta\text{DailyCookingEnergy} &= (122 * 0.0732 / 0.74) - (122 * 0.0732 / 0.80) \\ &= 0.9 \text{ kWh} \end{aligned}$$

$$\begin{aligned} \Delta\text{kWh} &= (4.7 + 0.03 + 0.9) * 365.25 \\ &= 2056 \text{ kWh} \end{aligned}$$

An ENERGY STAR full sized electric oven < 5 pans compared to baseline electric oven using default values from above would save.

$$\Delta kWh = (\Delta Idle Energy + \Delta Cooking Energy) * Days / 100000$$

Where:

$$\begin{aligned} \Delta DailyIdleEnergy &= (1.29 * 10.2) - (1.0 * 10.0) \\ &= 3.2 \text{ kWh} \\ \Delta DailyPreheatEnergy &= (1 * 9 / 60 * 1.56) - (1 * 9 / 60 * 1.39) \\ &= 0.03 \text{ kWh} \\ \Delta DailyCookingEnergy &= (122 * 0.0732 / 0.765) - (122 * 0.0732 / 0.81) \\ &= 0.65 \text{ kWh} \\ \Delta kWh &= (3.2 + 0.03 + 0.65) * 365.25 \\ &= 1,417 \text{ kWh} \end{aligned}$$

An ENERGY STAR full sized >5 pan electric oven compared to baseline gas oven assuming 100 lbs food cooked per day and using other default values from above would save.

$$\begin{aligned} \text{SiteEnergySavings (MMBTUs)} &= [\text{GasConsumptionReplaced}] - [\text{ElectricConsumptionAdded}] \\ &= [(\text{DailyIdle Energy}_{\text{GasBase}} + \text{DailyPreheat Energy}_{\text{GasBase}} + \text{DailyCooking Energy}_{\text{GasBase}}) * 1/1,000,000 * \text{Days}] - \\ &\quad [(\text{DailyIdle Energy}_{\text{ElecEE}} + \text{DailyPreheat Energy}_{\text{ElecEE}} + \text{DailyCooking Energy}_{\text{ElecEE}}) * 3412/1,000,000 * \text{Days}] \end{aligned}$$

$$\begin{aligned} \text{DailyIdleEnergy}_{\text{GasBase}} &= (12,239 * 10.7) \\ &= 130957 \text{ btu} \\ \text{DailyPreheatEnergy}_{\text{GasBase}} &= (1 * 12 / 60 * 76,000) \\ &= 15200 \text{ btu} \\ \text{DailyCookingEnergy}_{\text{GasBase}} &= (100 * 250 / 0.47) \\ &= 53191 \text{ btu} \\ \text{DailyIdleEnergy}_{\text{ElecEE}} &= (1.2 * 10.6) \\ &= 12.7 \text{ kWh} \\ \text{DailyPreheatEnergy}_{\text{ElecEE}} &= (1 * 9 / 60 * 1.39) \\ &= 0.21 \text{ kWh} \\ \text{DailyCookingEnergy}_{\text{ElecEE}} &= (100 * 0.0732 / 0.80) \\ &= 9.2 \text{ kWh} \end{aligned}$$

$$\begin{aligned} \text{SiteEnergySavings (MMBTUs)} &= ((130957 + 15200 + 53191) * 1/1,000,000 * 365.25) - \\ &\quad ((12.7 + 0.21 + 9.2) * 3412/1,000,000 * 365.25) \\ &= 45.3 \text{ MMBtu} \end{aligned}$$

$$\begin{aligned} \text{If supported by an electric utility: } \Delta kWh &= \Delta \text{SiteEnergySavings} * 1,000,000 / 3,412 \\ &= 45.3 * 1,000,000 / 3,412 \\ &= 13,277 \text{ kWh} \end{aligned}$$

SUMMER COINCIDENT PEAK DEMAND SAVINGS

Non-fuel switch measures:

$$\Delta kW = ((\Delta \text{DailyIdle Energy} + \Delta \text{DailyPreheat Energy} + \Delta \text{DailyCooking Energy}) / \text{HOURS}_{\text{Day}} * CF$$

Fuel switch measures:

$$\Delta kW = - ((\text{DailyIdle Energy}_{\text{ElecEE}} + \text{DailyPreheat Energy}_{\text{ElecEE}} + \text{DailyCooking Energy}_{\text{ElecEE}}) / \text{HOURS}_{\text{Day}} * CF$$

Where:

$$CF = \text{Summer Peak Coincidence Factor} \\ = 0.90^{238}$$

Other values as defined above.

FOSSIL FUEL SAVINGS

Calculation provided together with Electric Energy Savings above.

WATER IMPACT DESCRIPTIONS AND CALCULATION

N/A

DEEMED O&M COST ADJUSTMENT CALCULATION

N/A

COST EFFECTIVENESS SCREENING AND LOAD REDUCTION FORECASTING WHEN FUEL SWITCHING

This measure can involve fuel switching from fossil fuel to electric.

For the purposes of forecasting load reductions due to fuel switch projects per Section 16-111.5B, changes in site energy use at the customer’s meter (using ΔkWh algorithm below), customer switching estimates, NTG, and any other adjustment factors deemed appropriate, should be used.

The inputs to cost effectiveness screening should reflect the actual impacts on the electric and fuel consumption at the customer meter and, for fuel switching measures, should therefore reflect the decrease in one fuel and increase in another, as opposed to the single savings value calculated in the “Electric and Fossil Fuel Energy Savings” section above. Therefore in addition to the calculation of savings claimed, the following values should be used to assess the cost effectiveness of the measure.

$$\Delta \text{Therms} = [\text{Gas Cooking Consumption Replaced}] \\ = [(\text{DailyIdle Energy}_{\text{GasBase}} + \text{DailyPreheat Energy}_{\text{GasBase}} + \text{DailyCooking Energy}_{\text{GasBase}}) * 1/100,000 * \text{Days}] \\ \Delta \text{kWh} = [\text{Electric Cooking Consumption Added}] \\ = - [(\text{DailyIdle Energy}_{\text{ElecEE}} + \text{DailyPreheat Energy}_{\text{ElecEE}} + \text{DailyCooking Energy}_{\text{ElecEE}}) * \text{Days}]$$

²³⁸ Itron, Inc. 2005. 2004-2005 Database for Energy Efficiency Resources (DEER) Update Study - Final Report. Prepared for Southern California Edison.

MEASURE CODE: CI-FSE-ESCV-V06-250101

REVIEW DEADLINE: 1/1/2029

4.2.6 ENERGY STAR Dishwasher

DESCRIPTION

This measure applies to ENERGY STAR high and low temp under counter, stationary single tank door type, single tank conveyor, and multiple tank conveyor dishwashers, as well as high temp pot, pan, and utensil dishwashers installed in a commercial kitchen.

This measure was developed to be applicable to the following program types: TOS. If applied to other program types, the measure savings should be verified.

DEFINITION OF EFFICIENT EQUIPMENT

To qualify for this measure the installed equipment must be an ENERGY STAR certified dishwasher meeting idle energy rate (kW), washing energy and water consumption (gallons/rack) limits, as determined by both machine type and sanitation approach (chemical/low temp versus high temp).

ENERGY STAR Requirements (Version 3.0, effective July 27, 2021)

Dishwasher Type	High Temp Efficiency Requirements			Low Temp Efficiency Requirements		
	Idle Energy Rate	Washing Energy	Water Consumption	Idle Energy Rate	Washing Energy	Water Consumption
Under Counter	≤ 0.30 kW	≤ 0.35 kWh/rack	≤ 0.86 GPR	≤ 0.25 kW	≤ 0.15 kWh/rack	≤ 1.19 GPR
Stationary Single Tank Door	≤ 0.55 kW	≤ 0.35 kWh/rack	≤ 0.89 GPR	≤ 0.30 kW	≤ 0.15 kWh/rack	≤ 1.18 GPR
Pot, Pan, and Utensil	≤ 0.90 kW	≤ 0.55 + 0.05 * SF _{rack}	≤ 0.58 GPSF	N/A		
Single Tank Conveyor	≤ 1.20 kW	≤ 0.36 kWh/rack	≤ 0.70 GPR	≤ 0.85 kW	≤ 0.16 kWh/rack	≤ 0.79 GPR
Multiple Tank Conveyor	≤ 1.85 kW	≤ 0.36 kWh/rack	≤ 0.54 GPR	≤ 1.00 kW	≤ 0.22 kWh/rack	≤ 0.54 GPR

DEFINITION OF BASELINE EQUIPMENT

The baseline equipment is a new dishwasher that is not ENERGY STAR certified.

DEEMED LIFETIME OF EFFICIENT EQUIPMENT

The expected measure life is assumed to be:²³⁹

Dishwasher Type		Equipment Life
Low Temp	Under Counter	10
	Stationary Single Tank Door	10
	Single Tank Conveyor	10
	Multi Tank Conveyor	10
High Temp	Under Counter	10
	Stationary Single Tank Door	10
	Single Tank Conveyor	10
	Multi Tank Conveyor	10
	Pot, Pan, and Utensil	10

DEEMED MEASURE COST

The incremental capital cost for this measure is provided below:²⁴⁰

Dishwasher Type		Incremental Cost
Low	Under Counter	\$234

²³⁹ Lifetime from ENERGY STAR Commercial Food Service Equipment Calculator, updated March 2024 which cites reference as “EPA/FSTC research on available models, 2013”

²⁴⁰ Measure cost from ENERGY STAR Commercial Kitchen Equipment Savings Calculator which cites reference as “Difference between a similar ENERGY STAR and non-qualifying model EPA research using AutoQuotes, 2016 (for high/low temp undercounter/single door) and 2012 (all other types)”.

Dishwasher Type		Incremental Cost
Temp	Stationary Single Tank Door	\$662
	Single Tank Conveyor	\$0
	Multi Tank Conveyor	\$970
High Temp	Under Counter	\$2,025
	Stationary Single Tank Door	\$995
	Single Tank Conveyor	\$2,050
	Multi Tank Conveyor	\$970
	Pot, Pan, and Utensil	\$1,710

LOADSHAPE

Loadshape C01 - Commercial Electric Cooking

COINCIDENCE FACTOR

Summer Peak Coincidence Factor for measure is provided below for different restaurant types:²⁴¹

Location	CF
Fast Food Limited Menu	0.32
Fast Food Expanded Menu	0.41
Pizza	0.46
Full Service Limited Menu	0.51
Full Service Expanded Menu	0.36
Cafeteria	0.39

Algorithm

CALCULATION OF SAVINGS

ENERGY STAR dishwashers save energy in three categories: building water heating, booster water heating and idle energy. Building water heating and booster water heating could be either electric or natural gas.

ELECTRIC ENERGY SAVINGS

Non-Fuel Switch measures:

Custom calculation below²⁴², otherwise use deemed values found within the tables that follow.

$$\Delta kWh = \Delta BuildingEnergy + \Delta BoosterEnergy + \Delta IdleEnergy$$

Where:

$$\begin{aligned} \Delta BuildingEnergy &= \text{Change in annual electric energy consumption of building water heater} \\ &= [(WaterUse_{Base} * RacksWashed * Days) * (\Delta T_{in} * 1.0 * 8.2 \div Eff_{Heater} \div 3,412)] - \\ &\quad [(WaterUse_{ESTAR} * RacksWashed * Days) * (\Delta T_{in} * 1.0 * 8.2 \div Eff_{Heater} \div 3,412)] \end{aligned}$$

$$\begin{aligned} \Delta BoosterEnergy &= \text{Annual electric energy consumption of booster water heater}^{243} \\ &= [(WaterUse_{Base} * RacksWashed * Days) * (\Delta T_{in} * 1.0 * 8.2 \div Eff_{Heater} \div 3,412)] - \\ &\quad [(WaterUse_{ESTAR} * RacksWashed * Days) * (\Delta T_{in} * 1.0 * 8.2 \div Eff_{Heater} \div 3,412)] \end{aligned}$$

²⁴¹ Values taken from Minnesota Technical Reference Manual (Version 2.2, effective May 2, 2018), ‘Electric Oven and Range’ measure and are based upon “Project on Restaurant Energy Performance-End-Use Monitoring and Analysis”, Appendixes I and II, Claar, et. al., May 1985

²⁴² Algorithms and assumptions derived from ENERGY STAR Commercial Kitchen Equipment Savings Calculator.

²⁴³ Booster water heater energy only applies to high-temperature dishwashers.

$$\begin{aligned} \Delta \text{IdleEnergy} &= \text{Annual idle electric energy consumption of dishwasher} \\ &= [\text{IdleDraw}_{\text{Base}} * (\text{Hours} * \text{Days} - \text{Days} * \text{RacksWashed} * \text{WashTime} \div 60)] - \\ &\quad [\text{IdleDraw}_{\text{ESTAR}} * (\text{Hours} * \text{Days} - \text{Days} * \text{RacksWashed} * \text{WashTime} \div 60)] \end{aligned}$$

Fuel-Switch / Electrification Measures:

Fuel-switching / electrification is only applicable in the following scenario:

Base Case: High Temp Dishwasher with an Electric Booster Heater and a Gas Building Heater

Measure Case: High Temp Heat Recovery Dishwasher with an Electric Booster Heater and no associated Building Heater energy usage.

Fuel-switch / electrification measures must product positive total energy savings (i.e., reduction in Btus at the premises) in order to qualify. The following algorithm can be used to determine eligibility:

$$\begin{aligned} \text{SiteEnergySavings (MMBTUs)} &= [\text{GasConsumptionReplaced} + \text{kWhConsumptionReplaced}] - \\ &\quad [\text{ElectricalConsumptionAdded}] \\ &= [\text{AnnualBuildingEnergy}_{\text{GasBaseTHERMS}} / 10 + \\ &\quad (\text{AnnualBoosterEnergy}_{\text{ElectricBase}} + \text{AnnualIdleEnergy}_{\text{ElectricBase}} + \\ &\quad \text{WaterEnergy}_{\text{GasBase}}) * 3,412 / 1,000,000] - \\ &\quad [(\text{AnnualBoosterEnergy}_{\text{ElectricMeasure}} + \text{AnnualIdleEnergy}_{\text{ElectricMeasure}} + \\ &\quad \text{WaterEnergy}_{\text{ElectricMeasure}}) * 3,412 / 1,000,000] \end{aligned}$$

If SiteEnergySavings calculated above is positive, the measure is eligible.

The appropriate savings claims are dependent on which utilities are supporting the measure as provided in a table below:

Measure Supported By:	Electric Utility Claims (kWh):	Gas Utility Claims (therms):
Electric utility only	SiteEnergySavings * 1,000,000/3,412	N/A
Electric and gas utility <small>(Note utilities may make alternative agreements to how savings are allocated as long as total MMBtu savings remain the same).</small>	%IncentiveElectric * SiteEnergySavings * 1,000,000/3,412	%IncentiveGas * SiteEnergySavings * 10
Gas utility only	N/A	SiteEnergySavings * 10

Where:

WaterUse_{Base} = Water use per rack (gal) of baseline dishwasher
= Custom or if unknown, use value from table below as determined by machine type and sanitation method

WaterUse_{ESTAR} = Water use per rack (gal) of ENERGY STAR dishwasher
= Custom or if unknown, use value from table below as determined by machine type and sanitation method

RacksWashed = Number of racks washed per day

	= Custom or if unknown, use value from table below as determined by machine type and sanitation method
Days	= Annual days of dishwasher operation = Custom or if unknown, use 365.25 days per year
ΔT_{in}	= Inlet water temperature increase (°F) = Custom or if unknown, use 70 °F for building water heaters and 40 °F for booster water heaters Note for Heat Recovery Dish Washers which accept cold water the temperature increase is 0 °F for building water heaters and 110 °F for booster water heaters.
1.0	= Specific heat of water (Btu/lb/°F)
8.2	= Density of water (lb/gal)
Eff_{Heater}	= Efficiency of water heater = Custom or if unknown, use 98% for electric building and booster water heaters
3,412	= kWh to Btu conversion factor
$IdleDraw_{Base}$	= Idle power draw (kW) of baseline dishwasher = Custom or if unknown, use value from table below as determined by machine type and sanitation method
$IdleDraw_{ESTAR}$	= Idle power draw (kW) of ENERGY STAR dishwasher = Custom or if unknown, use value from table below as determined by machine type and sanitation method
Hours	= Average daily hours of dishwasher operation = Custom or if unknown, use 18 hours per day
WashTime	= Typical wash time (min) = Custom or if unknown, use value from table below as determined by machine type and sanitation method
60	= Minutes to hours conversion factor

For example, an ENERGY STAR high-temperature, under counter dishwasher with electric building and electric booster water heating with defaults from the calculation above and the table below would save:

$$\Delta kWh = \Delta \text{BuildingEnergy} + \Delta \text{BoosterEnergy} + \Delta \text{IdleEnergy}$$

Where:

$$\begin{aligned} \Delta \text{BuildingEnergy} &= [(1.09 * 75 * 365.25) * (70 * 1.0 * 8.2 \div 0.98 \div 3,412)] - [(0.86 * 75 * 365.25) * (70 * 1.0 * 8.2 \div 0.98 \div 3,412)] \\ &= 1,082 \text{ kWh} \\ \Delta \text{BoosterEnergy} &= [(1.09 * 75 * 365.25) * (40 * 1.0 * 8.2 \div 0.98 \div 3,412)] - [(0.86 * 75 * 365.25) * (40 * 1.0 * 8.2 \div 0.98 \div 3,412)] \\ &= 618 \text{ kWh} \\ \Delta \text{IdleEnergy} &= [0.76 * (18 * 365.25 - 365.25 * 75 * 2.0 \div 60)] - [0.30 * (18 * 365.25 - 365.25 * 75 * 2.0 \div 60)] \\ &= 2,604 \text{ kWh} \\ \Delta kWh &= 1,082 + 618 + 2,604 \\ &= 4,514 \text{ kWh} \end{aligned}$$

Default values for WaterUse, RacksWashed, kW_{Idle}, and WashTime are presented in the table below.

Low Temperature	RacksWashed	WashTime	WaterUse		IdleDraw	
	All Dishwashers	All Dishwashers	Conventional	ENERGY STAR	Conventional	ENERGY STAR
Under Counter	75	2.0	1.73	1.19	0.50	0.25
Stationary Single Tank Door	280	1.5	2.10	1.18	0.60	0.30
Single Tank Conveyor	400	0.3	1.31	0.79	1.60	0.85
Multi Tank Conveyor	600	0.3	1.04	0.54	2.00	1.00
High Temperature	All Dishwashers	All Dishwashers	Conventional	ENERGY STAR	Conventional	ENERGY STAR
Under Counter	75	2.0	1.09	0.86	0.76	0.30
Stationary Single Tank Door	280	1.0	1.29	0.89	0.87	0.55
Single Tank Conveyor	400	0.3	0.87	0.70	1.93	1.20
Multi Tank Conveyor	600	0.2	0.97	0.54	2.59	1.85
Pot, Pan, and Utensil	280	3.0	0.70	0.58	1.20	0.90

Savings for all water heating combinations are presented in the tables below (calculated without rounding variables as provided above).

Electric building and electric booster water heating

Dishwasher Type		kWh _{Base}	kWh _{ESTAR}	ΔkWh
Low Temp	Under Counter	10,972	7,016	3,957
	Stationary Single Tank Door	39,306	21,937	17,369
	Single Tank Conveyor	42,230	24,795	17,434
	Multi Tank Conveyor	50,112	25,809	24,303
High Temp	Under Counter	12,363	8,058	4,305
	Stationary Single Tank Door	39,852	27,250	12,602
	Single Tank Conveyor	45,593	34,621	10,971
	Multi Tank Conveyor	72,523	42,759	29,764
	Pot, Pan, and Utensil	21,079	17,328	3,751

Electric building and natural gas booster water heating

Dishwasher Type		kWh _{Base}	kWh _{ESTAR}	ΔkWh
Low Temp	Under Counter	10,972	7,016	3,957
	Stationary Single Tank Door	39,306	21,937	17,369
	Single Tank Conveyor	42,230	24,795	17,434
	Multi Tank Conveyor	50,112	25,809	24,303
High Temp	Under Counter	9,432	5,746	3,687
	Stationary Single Tank Door	26,901	18,315	8,586
	Single Tank Conveyor	33,115	24,582	8,533
	Multi Tank Conveyor	51,655	31,141	20,513
	Pot, Pan, and Utensil	14,052	11,505	2,547

Natural gas building and electric booster water heating

Dishwasher Type		kWh _{Base}	kWh _{ESTAR}	ΔkWh
Low Temp	Under Counter	2,831	1,415	1,415
	Stationary Single Tank Door	2,411	1,205	1,205
	Single Tank Conveyor	9,350	4,967	4,383
	Multi Tank Conveyor	10,958	5,479	5,479
High Temp	Under Counter	7,234	4,011	3,223
	Stationary Single Tank Door	17,188	11,614	5,574
	Single Tank Conveyor	23,757	17,052	6,704
	Multi Tank Conveyor	36,004	22,429	13,575
	Pot, Pan, and Utensil	8,781	7,138	1,643

Natural gas building and natural gas booster water heating

Dishwasher Type		kWh _{Base}	kWh _{ESTAR}	ΔkWh
Low Temp	Under Counter	2,831	1,415	1,415
	Stationary Single Tank Door	2,411	1,205	1,205
	Single Tank Conveyor	9,350	4,967	4,383
	Multi Tank Conveyor	10,958	5,479	5,479
High Temp	Under Counter	4,303	1,698	2,604
	Stationary Single Tank Door	4,237	2,679	1,558
	Single Tank Conveyor	11,279	7,013	4,266
	Multi Tank Conveyor	15,136	10,811	4,325
	Pot, Pan, and Utensil	1,753	1,315	438

For example, the fuel switch measure of a High Temp Heat Recovery Dishwasher with an Electric Booster Heater and no associated Building Heater energy usage, in place of a High Temp Dishwasher with an Electric Booster Heater and a Gas Building Heater.

$$\begin{aligned} \text{SiteEnergySavings (MMBTUs)} &= [\text{GasConsumptionReplaced} + \text{kWhConsumptionReplaced}] - [\text{ElectricalConsumptionAdded}] \\ &= [\text{AnnualBuildingEnergy}_{\text{GasBaseTHERMS}} / 10 + (\text{AnnualBoosterEnergy}_{\text{ElectricBase}} + \text{AnnualIdleEnergy}_{\text{ElectricBase}} + \text{WaterEnergy}_{\text{GasBase}}) * 3,412 / 1,000,000] - [(\text{AnnualBoosterEnergy}_{\text{ElectricMeasure}} + \text{AnnualIdleEnergy}_{\text{ElectricMeasure}} + \text{WaterEnergy}_{\text{ElectricMeasure}}) * 3,412 / 1,000,000] \\ \text{AnnualBuildingEnergy}_{\text{GasBaseTHERMS}} &= (\text{WaterUse}_{\text{Base}} * \text{RacksWashed} * \text{Days}) * (\Delta T_{\text{in}} * 1.0 * 8.2 \div \text{Eff}_{\text{Heater}} \div 100,000) \\ &= (1.09 * 75 * 365.25) * (70 * 1 * 8.2 / 0.8 / 100,000) \\ &= 214 \text{ Therm} \\ \text{AnnualBoosterEnergy}_{\text{ElectricBase}} &= (\text{WaterUse}_{\text{Base}} * \text{RacksWashed} * \text{Days}) * (\Delta T_{\text{in}} * 1.0 * 8.2 \div \text{Eff}_{\text{Heater}} \div 3,412) \\ &= (1.09 * 75 * 365.25) * (40 * 1 * 8.2 / 0.98 / 3,412) \\ &= 2,929 \text{ kWh} \\ \text{AnnualIdleEnergy}_{\text{ElectricBase}} &= \text{IdleDraw}_{\text{Base}} * (\text{Hours} * \text{Days} - \text{Days} * \text{RacksWashed} * \text{WashTime} \div 60) \\ &= 0.76 * (18 * 365.25 - 365.25 * 75 * 2 / 60) \\ &= 4,303 \text{ kWh} \\ \text{WaterEnergy}_{\text{ElectricBase}} &= (\text{WaterUse}_{\text{Base}} * \text{RacksWashed} * \text{Days}) / 1,000,000 * 5,010 \\ &= (0.86 * 75 * 365.25) / 1,000,000 * 5,010 \\ &= 150 \text{ kWh} \\ \text{AnnualBoosterEnergy}_{\text{ElectricMeasure}} &= (\text{WaterUse}_{\text{Measure}} * \text{RacksWashed} * \text{Days}) * (\Delta T_{\text{in}} * 1.0 * 8.2 \div \text{Eff}_{\text{Heater}} \div 3,412) \\ &= (0.86 * 75 * 365.25) * (110 * 1 * 8.2 / 0.98 / 3,412) \\ &= 6,355 \text{ kWh} \\ \text{AnnualIdleEnergy}_{\text{ElectricMeasure}} &= \text{IdleDraw}_{\text{Measure}} * (\text{Hours} * \text{Days} - \text{Days} * \text{RacksWashed} * \text{WashTime} \div 60) \\ &= 0.3 * (18 * 365.25 - 365.25 * 75 * 2 / 60) \\ &= 1,698 \text{ kWh} \\ \text{WaterEnergy}_{\text{ElectricMeasure}} &= (\text{WaterUse}_{\text{Measure}} * \text{RacksWashed} * \text{Days}) / 1,000,000 * 5,010 \\ &= (0.86 * 75 * 365.25) / 1,000,000 * 5,010 \\ &= 118 \text{ kWh} \\ \text{SiteEnergySavings (MMBTUs)} &= [214 / 10 + (2,929 + 4,303 + 150) * 3,412 / 1,000,000] - [(6,355 + 1,698 + 118) * 3,412 / 1,000,000] \\ &= 18.7 \text{ MMBTU} \\ \text{If supported by an electric utility} &= \text{SiteEnergySavings} * 1,000,000 / 3,412 \\ &= 18.7 * 1,000,000 / 3,412 \\ &= 5,481 \text{ kWh} \end{aligned}$$

Secondary kWh Savings for Water Supply and Wastewater Treatment

The following savings should be included in the total savings for this measure, but should not be included in TRC tests to avoid double counting the economic benefit of water savings.

$$\Delta kWh_{water} = \Delta Water \text{ (gallons)} / 1,000,000 * E_{water \text{ total}}$$

Where

$$E_{water \text{ total}} = \text{IL Total Water Energy Factor (kWh/Million Gallons)}$$

$$= 5,010^{244}$$

For example, an ENERGY STAR low-temperature, under-counter dishwasher with defaults from the calculation above and the table within the electric energy savings characterization would save:

$$\Delta Water = (WaterUse_{Base} * RacksWashed * Days) - (WaterUse_{ESTAR} * RacksWashed * Days)$$

$\Delta Water \text{ (gallons)}$	$= (1.73 * 75 * 365.25) - (1.19 * 75 * 365.25)$
	$= 14,793 \text{ gallons}$
ΔkWh_{water}	$= 14,793 / 1,000,000 * 5,010$
	$= 74 \text{ kWh}$

SUMMER COINCIDENT PEAK DEMAND SAVINGS

$$\Delta kW = \Delta kWh / \text{AnnualHours} * CF$$

Where:

- ΔkWh = Annual kWh savings from measure as calculated above. Note: do not include the secondary savings in this calculation.
- AnnualHours = Hours * Days
= Custom, or if unknown assume (18 * 365.25 =) 6575 annual hours
- CF = Summer Peak Coincidence Factor
= dependent on restaurant type:²⁴⁵

Location	CF
Fast Food Limited Menu	0.32
Fast Food Expanded Menu	0.41
Pizza	0.46
Full Service Limited Menu	0.51
Full Service Expanded Menu	0.36
Cafeteria	0.39

²⁴⁴ This factor include 2571 kWh/MG for water supply based on Illinois energy intensity data from a 2012 ISAWWA study and 2439 kWh/MG for wastewater treatment based on national energy intensity use estimates. For more information please review Elevate Energy’s ‘IL TRM: Energy per Gallon Factor, May 2018 paper’.

²⁴⁵ Values taken from Minnesota Technical Reference Manual (Version 2.2, effective May 2, 2018), ‘Electric Oven and Range’ measure and are based upon “Project on Restaurant Energy Performance-End-Use Monitoring and Analysis”, Appendixes I and II, Claar, et. al., May 1985.

For example, a low temperature undercounter dishwasher in a Full Service Limited Menu restaurant with electric building and booster water heaters would save:

$$\begin{aligned} \Delta kW &= \Delta kWh / \text{AnnualHours} * CF \\ &= 3957 / 6575 * 0.51 \\ &= 0.307 \text{ kW} \end{aligned}$$

FOSSIL FUEL SAVINGS

$$\Delta \text{Therms} = \Delta \text{BuildingEnergy} + \Delta \text{BoosterEnergy}$$

Where:

$$\begin{aligned} \Delta \text{BuildingEnergy} &= \text{Change in annual natural gas consumption of building water heater} \\ &= [(WaterUse_{Base} * RacksWashed * Days) * (\Delta T_{in} * 1.0 * 8.2 \div Eff_{Heater} \div 100,000)] - \\ &\quad [(WaterUse_{ESTAR} * RacksWashed * Days) * (\Delta T_{in} * 1.0 * 8.2 \div Eff_{Heater} \div 100,000)] \end{aligned}$$

$$\begin{aligned} \Delta \text{BoosterEnergy} &= \text{Change in annual natural gas consumption of booster water heater} \\ &= [(WaterUse_{Base} * RacksWashed * Days) * (\Delta T_{in} * 1.0 * 8.2 \div Eff_{Heater} \div 100,000)] - \\ &\quad [(WaterUse_{ESTAR} * RacksWashed * Days) * (\Delta T_{in} * 1.0 * 8.2 \div Eff_{Heater} \div 100,000)] \end{aligned}$$

Where:

- WaterUse_{Base} = Water use per rack (gal) of baseline dishwasher
= Custom or if unknown, use value from table within the electric energy savings characterization as determined by machine type and sanitation method
- WaterUse_{ESTAR} = Water use per rack (gal) of ENERGY STAR dishwasher
= Custom or if unknown, use value from table within the electric energy savings characterization as determined by machine type and sanitation method
- RacksWashed = Number of racks washed per day
= Custom or if unknown, use value from table within the electric energy savings characterization as determined by machine type and sanitation method
- Days = Annual days of dishwasher operation
= Custom or if unknown, use 365 days per year
- ΔT_{in} = Inlet water temperature increase (°F)
= Custom or if unknown, use 70 °F for building water heaters and 40 °F for booster water heaters
- 1.0 = Specific heat of water (Btu/lb/°F)
- 8.2 = Density of water (lb/gal)
- Eff_{Heater} = Efficiency of water heater
= Custom or 80% for gas building and booster water heaters
- 100,000 = Therms to Btu conversion factor

For example, an ENERGY STAR high-temperature, under counter dishwasher with gas building and gas booster water heating with defaults from the calculation above and the table within the electric energy savings characterization would save:

$$\Delta\text{Therms} = \Delta\text{BuildingEnergy} + \Delta\text{BoosterEnergy}$$

Where:

$$\begin{aligned} \Delta\text{BuildingEnergy} &= [(1.09 * 75 * 365.25) * (70 * 1.0 * 8.2 \div 0.80 \div 100,000)] - [(0.86 * 75 * 365.25) * (70 * 1.0 * 8.2 \div 0.80 \div 100,000)] \\ &= 45 \text{ therms} \\ \Delta\text{BoosterEnergy} &= [(1.09 * 75 * 365.25) * (40 * 1.0 * 8.2 \div 0.80 \div 100,000)] - [(0.86 * 75 * 365.25) * (40 * 1.0 * 8.2 \div 0.80 \div 100,000)] \\ &= 26 \text{ therms} \\ \Delta\text{Therms} &= 45 + 26 \\ &= 71 \text{ therms} \end{aligned}$$

Savings for all water heating combinations are presented in the tables below.

Electric building and natural gas booster water heating

Dishwasher Type		Therms _{Base}	Therms _{ESTAR}	ΔTherms
Low Temp	Under Counter	NA	NA	NA
	Stationary Single Tank Door	NA	NA	NA
	Single Tank Conveyor	NA	NA	NA
	Multi Tank Conveyor	NA	NA	NA
High Temp	Under Counter	123	97	26
	Stationary Single Tank Door	541	374	168
	Single Tank Conveyor	522	420	102
	Stationary Single Tank Door	872	486	387
	Pot, Pan, and Utensil	294	243	50

Natural gas building and natural gas booster water heating

Dishwasher Type		Therms _{Base}	Therms _{ESTAR}	ΔTherms
Low Temp	Under Counter	340	234	106
	Stationary Single Tank Door	1,543	867	676
	Single Tank Conveyor	1,375	829	546
	Multi Tank Conveyor	1,637	850	787
High Temp	Under Counter	337	266	71
	Stationary Single Tank Door	1,489	1,027	462
	Single Tank Conveyor	1,435	1,154	280
	Multi Tank Conveyor	2,399	1,336	1,064
	Pot, Pan, and Utensil	808	669	139

Natural gas building and electric booster water heating

Dishwasher Type		Therms _{Base}	Therms _{ESTAR}	ΔTherms
Low Temp	Under Counter	340	234	106
	Stationary Single Tank Door	1,543	867	676
	Single Tank Conveyor	1,375	829	546
	Multi Tank Conveyor	1,637	850	787
High Temp	Under Counter	214	169	45

Dishwasher Type		Therms _{Base}	Therms _{ESTAR}	ΔTherms
High Temp	Stationary Single Tank Door	948	654	294
	Single Tank Conveyor	913	735	178
	Multi Tank Conveyor	1,527	850	677
	Pot, Pan, and Utensil	514	426	88

WATER IMPACT DESCRIPTIONS AND CALCULATION

$$\Delta\text{Water} = (\text{WaterUse}_{\text{Base}} * \text{RacksWashed} * \text{Days}) - (\text{WaterUse}_{\text{ESTAR}} * \text{RacksWashed} * \text{Days})$$

Where:

- WaterUse_{Base} = Water use per rack (gal) of baseline dishwasher
= Custom or if unknown, use value from table within the electric energy savings characterization as determined by machine type and sanitation method
- WaterUse_{ESTAR} = Water use per rack (gal) of ENERGY STAR dishwasher
= Custom or if unknown, use value from table within the electric energy savings characterization as determined by machine type and sanitation method
- RacksWashed = Number of racks washed per day
= Custom or if unknown, use value from table within the electric energy savings characterization as determined by machine type and sanitation method
- Days = Annual days of dishwasher operation
= Custom or if unknown, use 365 days per year

For example, an ENERGY STAR low-temperature, under counter dishwasher with defaults from the calculation above and the table within the electric energy savings characterization would save:

$$\begin{aligned} \Delta\text{Water} &= (\text{WaterUse}_{\text{Base}} * \text{RacksWashed} * \text{Days}) - (\text{WaterUse}_{\text{ESTAR}} * \text{RacksWashed} * \text{Days}) \\ \Delta\text{Water (gallons)} &= (1.73 * 75 * 365.25) - (1.19 * 75 * 365.25) \\ &= 14,793 \text{ gallons} \end{aligned}$$

Savings for all dishwasher types are presented in the table below.

	Annual Water Consumption (gallons)		
	Baseline	ENERGY STAR	Savings
Low Temperature			
Under Counter	47,391	32,599	14,793
Stationary Single Tank Door	214,767	120,679	94,088
Single Tank Conveyor	191,391	115,419	75,972
Multi Tank Conveyor	227,916	118,341	109,575
High Temperature			
Under Counter	29,859	23,559	6,301
Stationary Single Tank Door	131,928	91,020	40,908
Single Tank Conveyor	127,107	102,270	24,837
Multi Tank Conveyor	212,576	118,341	94,235
Pot, Pan, and Utensil	71,589	59,317	12,272

DEEMED O&M COST ADJUSTMENT CALCULATION

N/A

COST EFFECTIVENESS SCREENING AND LOAD REDUCTION FORECASTING WHEN FUEL SWITCHING

This measure can involve fuel switching from fossil fuel to electric.

For the purposes of forecasting load reductions due to fuel switch projects per Section 16-111.5B, changes in site energy use at the customer’s meter (using ΔkWh algorithm below), customer switching estimates, NTG, and any other adjustment factors deemed appropriate, should be used.

The inputs to cost effectiveness screening should reflect the actual impacts on the electric and fuel consumption at the customer meter and, for fuel switching measures, should therefore reflect the decrease in one fuel and increase in another, as opposed to the single savings value calculated in the “Electric and Fossil Fuel Energy Savings” section above. Therefore in addition to the calculation of savings claimed, the following values should be used to assess the cost effectiveness of the measure.

$$\begin{aligned} \Delta\text{Therms} &= [\text{Gas Consumption Replaced}] \\ &= [((\text{WaterUse}_{\text{Base}} * \text{RacksWashed} * \text{Days}) * (\Delta T_{\text{in}} * 1.0 * 8.2 / \text{Eff}_{\text{Heater}} / 100,000)) + \\ &\quad ((\text{WaterUse}_{\text{Base}} * \text{RacksWashed} * \text{Days}) * (\Delta T_{\text{in}} * 1.0 * 8.2 / \text{Eff}_{\text{Heater}} / 100,000))] \\ \Delta\text{kWh} &= [\text{Electric Consumption Added}] \\ &= - [(((\text{WaterUse}_{\text{ESTAR}} * \text{RacksWashed} * \text{Days}) * (\Delta T_{\text{in}} * 1.0 * 8.2 / \text{Eff}_{\text{Heater}} / 3,412))) + \\ &\quad (((\text{WaterUse}_{\text{ESTAR}} * \text{RacksWashed} * \text{Days}) * (\Delta T_{\text{in}} * 1.0 * 8.2 / \text{Eff}_{\text{Heater}} / 3,412))) + \\ &\quad ((\text{IdleDraw}_{\text{ESTAR}} * (\text{Hours} * \text{Days} - \text{Days} * \text{RacksWashed} * \text{WashTime} / 60)))] \end{aligned}$$

MEASURE CODE: CI-FSE-ESDW-V08-250101

REVIEW DEADLINE: 1/1/2026

4.2.7 ENERGY STAR Fryer

DESCRIPTION

This measure applies to electric or natural gas fired ENERGY STAR certified fryers installed in a commercial kitchen.

This measure was developed to be applicable to the following program types: TOS. If applied to other program types, the measure savings should be verified.

DEFINITION OF EFFICIENT EQUIPMENT

To qualify for this measure, the installed equipment must be an ENERGY STAR certified fryer meeting idle energy rate (W or Btu/hr) and cooking efficiency (%) limits, as determined by both fuel type and fryer capacity (standard versus large vat).

ENERGY STAR Requirements (Version 3.0, Effective October 1, 2016)

Fryer Capacity	Electric Efficiency Requirements		Natural Gas Efficiency Requirements	
	Idle Energy Rate	Cooking Efficiency Consumption	Idle Energy Rate	Cooking Efficiency Consumption
Standard Open Deep-Fat Fryer	≤ 800 W	≥ 83%	≤ 9,000 Btu/hr	≥ 50%
Large Vat Open Deep-Fat Fryer	≤ 1,100 W	≥ 80%	≤ 12,000 Btu/hr	

DEFINITION OF BASELINE EQUIPMENT

The baseline equipment is a new electric or natural gas fryer that is not ENERGY STAR certified.

DEEMED LIFETIME OF EFFICIENT EQUIPMENT

The expected measure life is assumed to be 12 years.²⁴⁶

DEEMED MEASURE COST

For the incremental capital costs, please see the table below:²⁴⁷

Fuel Source	Size	Incremental Cost
Electric	Standard	\$1,500
	Large Vat	\$500
Natural Gas	Standard	\$1,000
	Large Vat	\$2,000

LOADSHAPE

Loadshape C01 - Commercial Electric Cooking

COINCIDENCE FACTOR

Summer Peak Coincidence Factor for measure is assumed to be 0.90.²⁴⁸

²⁴⁶Lifetime from ENERGY STAR Commercial Kitchen Equipment Savings Calculator 03-2021, which cites reference as “FSTC research on available models, 2009.

²⁴⁷Measure cost from ENERGY STAR Commercial Kitchen Equipment Savings Calculator (last updated March 2021) which cites reference as “Difference between a similar ENERGY STAR and non-qualifying model, EPA research using AutoQuotes, October 2020”.

²⁴⁸Itron, Inc. 2005. 2004-2005 Database for Energy Efficiency Resources (DEER) Update Study - Final Report. Prepared for Southern California Edison.

Algorithm

CALCULATION OF SAVINGS

ELECTRIC AND FOSSIL FUEL ENERGY SAVINGS

Non-Fuel Switch Measures

The algorithm below applies to ENERGY STAR compared to baseline electric fryer:

$$\Delta kWh = (\Delta DailyIdleEnergy + \Delta DailyPreheatEnergy + \Delta DailyCookingEnergy) * Days / 1,000$$

The algorithm below applies to ENERGY STAR compared to baseline gas fryer:

$$\Delta Therms = (\Delta DailyIdleEnergy + \Delta DailyPreheatEnergy + \Delta DailyCookingEnergy) * Days / 100,000$$

Fuel Switch/Electrification Measures:

Fuel switch / electrification measures must produce positive total energy savings (i.e., reduction in Btus at the premises) in order to qualify. This is determined as follows:

$$\begin{aligned} \text{SiteEnergySavings (MMBTUs)} &= [\text{GasConsumptionReplaced}] - [\text{ElectricConsumptionAdded}] \\ &= [(\text{DailyIdleEnergy}_{\text{GasBase}} + \text{DailyPreheatEnergy}_{\text{GasBase}} + \text{DailyCookingEnergy}_{\text{GasBase}}) * 1/1,000,000 * \text{Days}] - \\ &\quad [(\text{DailyIdleEnergy}_{\text{ElecEE}} + \text{DailyPreheatEnergy}_{\text{ElecEE}} + \text{DailyCookingEnergy}_{\text{ElecEE}}) * 3.412/1,000,000 * \text{Days}] \end{aligned}$$

If SiteEnergySavings calculated above is positive, the measure is eligible.

The appropriate savings claim is dependent on which utilities are supporting the measure as provided in a table below:

Measure Supported By:	Electric Utility Claims (kWh):	Gas Utility Claims (therms):
Electric utility only	SiteEnergySavings * 1,000,000/3,412	N/A
Electric and gas utility (Note utilities may make alternative agreements to how savings are allocated as long as total MMBtu savings remains the same).	%IncentiveElectric * SiteEnergySavings * 1,000,000/3,412	%IncentiveGas * SiteEnergySavings * 10
Gas utility only	N/A	SiteEnergySavings * 10

$$\Delta DailyIdleEnergy = (\text{Idle}_{\text{Base}} * ((\text{HOURS} - (\text{PreheatTime}/60)) - \text{LB}/\text{PC}_{\text{Base}})) - (\text{Idle}_{\text{ESTAR}} * ((\text{HOURS} - (\text{PreheatTime}/60)) - \text{LB}/\text{PC}_{\text{ESTAR}}))$$

$$\Delta DailyPreheatEnergy = (\text{PreheatEnergy}_{\text{Base}} - \text{PreheatEnergy}_{\text{ESTAR}}) * 1,000$$

$$\Delta DailyCookingEnergy = (\text{LB} * \text{EFOOD}/\text{Eff}_{\text{Base}}) - (\text{LB} * \text{EFOOD}/\text{Eff}_{\text{ESTAR}})$$

$$\text{DailyIdle Energy}_{\text{GasBase}} = (\text{Idle}_{\text{BaseGas}} * ((\text{HOURS} - (\text{PreheatTime}/60)) - \text{LB}/\text{PC}_{\text{BaseGas}}))$$

$$\text{DailyCooking Energy}_{\text{GasBase}} = (\text{LB} * \text{EFOOD}/\text{Eff}_{\text{BaseGas}})$$

$$\text{DailyIdle Energy}_{\text{ElecEE}} = (\text{Idle}_{\text{ESTARElec}} * ((\text{HOURS} - (\text{PreheatTime}/60)) - \text{LB}/\text{PC}_{\text{ESTARElec}}))$$

$$\text{DailyCooking Energy}_{\text{ElecEE}} = (\text{LB} * \text{EFOOD} / \text{Eff}_{\text{ESTAR}})$$

Where²⁴⁹:

$\text{Idle}_{\text{Base}}$ = Idle energy rate of baseline fryer

Fryer Type	$\text{Idle}_{\text{Base}}$
Electric Standard	1,200 W/h
Electric Large Vat	1,350 W/h
Natural Gas Standard	14,000 Btu/h
Natural Gas Large Vat	16,000 Btu/h

$\text{Idle}_{\text{ESTAR}}$ = Idle energy rate of ENERGY STAR electric fryer

= Actual, if unknown use:

Fryer Type	$\text{Idle}_{\text{ESTAR}}$
Electric Standard	800 W/h
Electric Large Vat	1,100 W/h
Natural Gas Standard	9,000 Btu/h
Natural Gas Large Vat	12,000 Btu/h

HOURS = Average daily hours of operation

= Actual or if unknown, use 16 hours per day for a standard fryer and 12 hours per day for a large vat fryer

PreheatTime = Time required to preheat the fryer

= 15 minutes per day

60 = minutes to hours conversion factor

LB = Food cooked per day

= Actual or if unknown, use 150 pounds

PC_{Base} = Production capacity of baseline fryer (lb/h)

Fryer Type	PC_{Base} (lb/h)
Electric Standard	65
Electric Large Vat	100
Natural Gas Standard	60
Natural Gas Large Vat	100

PC_{ESTAR} = Production capacity of ENERGY STAR fryer

= Actual or if unknown, use

Fryer Type	PC_{Base} (lb/h)
Electric Standard	70
Electric Large Vat	110

²⁴⁹ Algorithms and assumptions derived from ENERGY STAR Commercial Kitchen Equipment Savings Calculator (last updated March 2021).

Natural Gas Standard	65
Natural Gas Large Vat	110

PreheatEnergy_{Base} = Total energy used during preheat of baseline fryer
 = 2.4 kWh for electric fryers and 18,500Btu for gas fryers

PreheatEnergy_{ESTAR} = Total energy used during preheat of ENERGY STAR fryer
 = Actual, or if unknown assume 1.9 kWh for electric fryers and 16,000Btu for gas fryers

E_{FOOD} = ASTM energy to food
 = 167 Wh/lb for electric fryers and 570 Btu/lb for gas fryers

Eff_{Base} = Cooking efficiency of baseline electric fryer

Fryer Type	Eff _{Base}
Electric Standard	75%
Electric Large Vat	70%
Natural Gas Standard	35%
Natural Gas Large Vat	35%

Eff_{ESTAR} = Cooking efficiency of ENERGY STAR electric fryer
 = Actual or if unknown use:

Fryer Type	Eff _{ESTAR}
Electric Standard	83%
Electric Large Vat	80%
Natural Gas Standard	50%
Natural Gas Large Vat	50%

Days = Annual days of operation
 = Custom, or if unknown, use 365.25 days per year

1,000 = Wh to kWh conversion factor

100,000 = Btu to therms conversion factor

For example, an ENERGY STAR standard-sized electric fryer, using default values from the calculation above, would save:

$$\Delta\text{kWh} = (\Delta\text{DailyIdleEnergy} + \Delta\text{DailyPreheatEnergy} + \Delta\text{DailyCookingEnergy}) * \text{Days} / 1,000$$

Where:

$$\begin{aligned} \Delta\text{DailyIdleEnergy} &= (1,200 * ((16 - 15/60) - 150 / 65)) - (800 * ((16 - 15/60) - 150 / 70)) \\ &= 5,245 \text{ Wh} \end{aligned}$$

$$\begin{aligned} \Delta\text{DailyPreheatEnergy} &= (2.4 - 1.9) * 1,000 \\ &= 500 \text{ Wh} \end{aligned}$$

$$\begin{aligned} \Delta\text{DailyCookingEnergy} &= (150 * 167 / 0.75) - (150 * 167 / 0.83) \\ &= 3,219 \text{ Wh} \end{aligned}$$

$$\begin{aligned} \Delta\text{kWh} &= (5,245 + 500 + 3,219) * 365.25 / 1,000 \\ &= 3,274.2 \text{ kWh} \end{aligned}$$

$$[\text{Electric Large Vat using defaults} = 2,697.6 \text{ kWh}]$$

For example, an ENERGY STAR standard-sized gas fryer, using default values from the calculation above, would save:

$$\Delta\text{Therms} = (\Delta\text{DailyIdleEnergy} + \Delta\text{DailyPreheatEnergy} + \Delta\text{DailyCookingEnergy}) * \text{Days} / 100,000$$

Where:

$$\begin{aligned} \Delta\text{DailyIdleEnergy} &= (14,000 * ((16 - 15/60) - 150 / 60)) - (9,000 * ((16 - 15/60) - 150 / 65)) \\ &= 64,519 \text{ Btu/day} \end{aligned}$$

$$\begin{aligned} \Delta\text{DailyPreheatEnergy} &= 18,500 - 16,000 \\ &= 2,500 \text{ Btu/day} \end{aligned}$$

$$\begin{aligned} \Delta\text{DailyCookingEnergy} &= (150 * 570 / 0.35) - (150 * 570 / 0.50) \\ &= 73,286 \text{ Btu/day} \end{aligned}$$

$$\begin{aligned} \Delta\text{Therms} &= (64,519 + 2,500 + 73,286) * 365.25 / 100,000 \\ &= 512.5 \text{ therms} \end{aligned}$$

$$[\text{Gas Large Vat using defaults} = 420.6 \text{ therms}]$$

An ENERGY STAR standard-sized electric fryer compared to baseline gas fryer assuming default values from above would save.

$$\begin{aligned} \text{SiteEnergySavings (MMBTUs)} &= [\text{GasConsumptionReplaced}] - [\text{ElectricConsumptionAdded}] \\ &= [(\text{DailyIdleEnergy}_{\text{GasBase}} + \text{DailyPreheatEnergy}_{\text{GasBase}} + \\ &\quad \text{DailyCookingEnergy}_{\text{GasBase}}) * 1/1,000,000 * \text{Days}] - \\ &\quad [(\text{DailyIdleEnergy}_{\text{ElecEE}} + \text{DailyPreheatEnergy}_{\text{ElecEE}} + \\ &\quad \text{DailyCookingEnergy}_{\text{ElecEE}}) * 3.412/1,000,000 * \text{Days}] \end{aligned}$$

$$\begin{aligned} \text{DailyIdleEnergy}_{\text{GasBase}} &= (14,000 * ((16 - 15/60) - 150 / 60)) \\ &= 185,500 \text{ btu} \end{aligned}$$

$$\text{DailyPreheatEnergy}_{\text{GasBase}} = 18,500 \text{ btu}$$

$$\begin{aligned} \text{DailyCookingEnergy}_{\text{GasBase}} &= (150 * 570 / 0.35) \\ &= 244,286 \text{ btu} \end{aligned}$$

$$\begin{aligned} \text{DailyIdleEnergy}_{\text{ElecEE}} &= (800 * ((16 - 15/60) - 150 / 70)) \\ &= 10,886 \text{ Wh} \end{aligned}$$

$$\begin{aligned} \text{DailyPreheatEnergy}_{\text{ElecEE}} &= 1.9 * 1,000 \\ &= 1,900 \text{ Wh} \end{aligned}$$

$$\begin{aligned} \text{DailyCookingEnergy}_{\text{ElecEE}} &= (150 * 167 / 0.83) \\ &= 30,181 \text{ Wh} \end{aligned}$$

$$\begin{aligned} \text{SiteEnergySavings (MMBTUs)} &= ((185,500 + 18,500 + 244,286) * 1/1,000,000 * 365.25) - \\ &\quad ((10,886 + 1,900 + 30,181) * 3.412/1,000,000 * 365.25) \\ &= 110 \text{ MMBtu} \end{aligned}$$

$$\begin{aligned} \text{If supported by an electric utility: } \Delta \text{kWh} &= \Delta \text{SiteEnergySavings} * 1,000,000 / 3,412 \\ &= 110 * 1,000,000/3,412 \\ &= 32,239 \text{ kWh} \end{aligned}$$

[Using Large Vat defaults = 103 MMBtu or 30,188 kWh]

SUMMER COINCIDENT PEAK DEMAND SAVINGS

$$\Delta \text{kW} = ((\Delta \text{DailyIdleEnergy} + \Delta \text{DailyPreheatEnergy} + \Delta \text{DailyCookingEnergy}) / (1,000 * \text{HOURS}) * \text{CF}$$

$$\Delta \text{kW} = - ((\text{DailyIdleEnergy}_{\text{ElecEE}} + \text{DailyPreheatEnergy}_{\text{ElecEE}} + \text{DailyCookingEnergy}_{\text{ElecEE}}) / (1,000 * \text{HOURS}) * \text{CF}$$

Where:

$$\begin{aligned} \text{CF} &= \text{Summer Peak Coincidence Factor} \\ &= 0.90^{250} \end{aligned}$$

Other variables as defined above.

²⁵⁰ Itron, Inc. 2005. 2004-2005 Database for Energy Efficiency Resources (DEER) Update Study - Final Report. Prepared for Southern California Edison.

For example, an ENERGY STAR standard-sized electric fryer in a cafeteria, using default values from the calculation above, would save:

$$\begin{aligned} \Delta kW &= (5,245 + 500 + 3,219)/(1000 * HOURS) * CF \\ &= 8964 / (1000 * 16) * 0.9 \\ &= 0.504 kW \end{aligned}$$

FOSSIL FUEL SAVINGS

Calculation provided together with Electric Energy Savings above.

WATER IMPACT DESCRIPTIONS AND CALCULATION

N/A

DEEMED O&M COST ADJUSTMENT CALCULATION

N/A

COST EFFECTIVENESS SCREENING AND LOAD REDUCTION FORECASTING WHEN FUEL SWITCHING

This measure can involve fuel switching from fossil fuel to electric.

For the purposes of forecasting load reductions due to fuel switch projects per Section 16-111.5B, changes in site energy use at the customer’s meter (using ΔkWh algorithm below), customer switching estimates, NTG, and any other adjustment factors deemed appropriate, should be used.

The inputs to cost effectiveness screening should reflect the actual impacts on the electric and fuel consumption at the customer meter and, for fuel switching measures, should therefore reflect the decrease in one fuel and increase in another, as opposed to the single savings value calculated in the “Electric and Fossil Fuel Energy Savings” section above. Therefore in addition to the calculation of savings claimed, the following values should be used to assess the cost effectiveness of the measure.

$$\begin{aligned} \Delta \text{Therms} &= [\text{Gas Cooking Consumption Replaced}] \\ &= [(\text{DailyIdleEnergy}_{\text{GasBase}} + \text{DailyPreheatEnergy}_{\text{GasBase}} + \text{DailyCookingEnergy}_{\text{GasBase}}) * \\ &\quad 1/100,000 * \text{Days}] \\ \Delta \text{kWh} &= [\text{Electric Cooking Consumption Added}] \\ &= - [(\text{DailyIdleEnergy}_{\text{ElecEE}} + \text{DailyPreheatEnergy}_{\text{ElecEE}} + \text{DailyCookingEnergy}_{\text{ElecEE}}) * \text{Days} / \\ &\quad 1,000] \end{aligned}$$

MEASURE CODE: CI-FSE-ESFR-V06-250101

REVIEW DEADLINE: 1/1/2028

4.2.8 ENERGY STAR Griddle

DESCRIPTION

This measure applies to single or double-sided electric, natural gas fired, or dual fuel ENERGY STAR griddles installed in a commercial kitchen. For dual fuel griddles, savings should be divided between electric and gas as described in the Fossil Fuel Savings section of this measure.

This measure was developed to be applicable to the following program types: TOS. If applied to other program types, the measure savings should be verified.

DEFINITION OF EFFICIENT EQUIPMENT

To qualify for this measure the installed equipment must be a single or double-sided natural gas, electric, or dual fuel ENERGY STAR griddle with a tested heavy load cooking energy efficiency of 70 percent (electric) 38 percent (gas) or greater and an idle energy rate of 2,650 Btu/hr per square foot of cooking surface or less, utilizing ASTM F1275. The griddle must have an Idle Energy Consumption Rate < 2,600 Btu/hr per square foot of cooking surface.

DEFINITION OF BASELINE EQUIPMENT

The baseline equipment is an existing natural gas or electric griddle that's not ENERGY STAR certified and is at end of use.

DEEMED LIFETIME OF EFFICIENT EQUIPMENT

The expected measure life is assumed to be 12 years.²⁵¹

DEEMED MEASURE COST

The incremental capital cost for this measure is \$0 for an electric griddle and \$60 for a gas griddle.²⁵²

LOADSHAPE

Loadshape C01 - Commercial Electric Cooking

COINCIDENCE FACTOR

Summer Peak Coincidence Factor for measure is assumed to be 0.90.²⁵³

Algorithm

CALCULATION OF SAVINGS²⁵⁴

ELECTRIC ENERGY AND FOSSIL FUEL SAVINGS

Non-Fuel Switch Measures

The algorithm below applies to ENERGY STAR compared to baseline electric griddles:

$$\Delta kWh = (\Delta IdleEnergy + \Delta PreheatEnergy + \Delta CookingEnergy) * Days / 1000$$

²⁵¹ Lifetime from ENERGY STAR Commercial Kitchen Equipment Calculator, Commercial Griddle Calculations, which cites reference as "FSTC research on available models, 2009".

²⁵² Measure cost from ENERGY STAR Commercial Kitchen Equipment Calculator, which cites reference as "EPA research on available models using AutoQuotes, 2010".

²⁵³ Itron, Inc. 2005. 2004-2005 Database for Energy Efficiency Resources (DEER) Update Study - Final Report. Prepared for Southern California Edison.

²⁵⁴ Algorithms and assumptions derived from ENERGY STAR Griddle Commercial Kitchen Equipment Savings Calculator.

The algorithm below applies to ENERGY STAR compared to baseline gas griddles:

$$\Delta\text{Therms} = (\Delta\text{IdleEnergy} + \Delta\text{PreheatEnergy} + \Delta\text{CookingEnergy}) * \text{Days} / 100,000$$

Fuel Switch/Electrification Measures:

Fuel switch / electrification measures must produce positive total energy savings (i.e., reduction in Btus at the premises) in order to qualify. This is determined as follows:

$$\begin{aligned} \text{SiteEnergySavings (MMBTUs)} &= [\text{GasConsumptionReplaced}] - [\text{ElectricConsumptionAdded}] \\ &= [(\text{DailyIdleEnergy}_{\text{GasBase}} + \text{DailyPreheatEnergy}_{\text{GasBase}} + \text{DailyCookingEnergy}_{\text{GasBase}}) * 1/1,000,000 * \text{Days}] - \\ & \quad [(\text{DailyIdleEnergy}_{\text{ElecEE}} + \text{DailyPreheatEnergy}_{\text{ElecEE}} + \text{DailyCookingEnergy}_{\text{ElecEE}}) * 3.412/1,000,000 * \text{Days}] \end{aligned}$$

If SiteEnergySavings calculated above is positive, the measure is eligible.

The appropriate savings claim is dependent on which utilities are supporting the measure as provided in a table below:

Measure SupportedBby:	Electric Utility Claims (kWh):	Gas Utility Claims (therms):
Electric utility only	SiteEnergySavings * 1,000,000/3,412	N/A
Electric and gas utility (Note utilities may make alternative agreements to how savings are allocated as long as total MMBtu savings remains the same).	%IncentiveElectric * SiteEnergySavings * 1,000,000/3,412	%IncentiveGas * SiteEnergySavings * 10
as utility only	N/A	SiteEnergySavings * 10

$$\Delta\text{DailyIdleEnergy} = [(\text{Idle}_{\text{Base}} * \text{Width} * \text{Depth} * (\text{HOURSday} - (\text{LB}/(\text{PC}_{\text{Base}} * \text{Width} * \text{Depth}) - (\text{PreheatNumber}_{\text{Base}} * \text{PreheatTime}_{\text{Base}}/60)))] - [(\text{Idle}_{\text{ENERGYSTAR}} * \text{Width} * \text{Depth} * (\text{HOURSday} - (\text{LB}/(\text{PC}_{\text{ENERGYSTAR}} * \text{Width} * \text{Depth}) - (\text{PreheatNumber}_{\text{ENERGYSTAR}} * \text{PreheatTime}_{\text{ENERGYSTAR}}/60)))]$$

$$\Delta\text{DailyPreheatEnergy} = (\text{PreHeatNumber}_{\text{Base}} * \text{PreheatTime}_{\text{Base}} / 60 * \text{PreheatRate}_{\text{Base}} * \text{Width} * \text{Depth}) - (\text{PreheatNumber}_{\text{ENERGYSTAR}} * \text{PreheatTime}_{\text{ENERGYSTAR}} / 60 * \text{PreheatRate}_{\text{ENERGYSTAR}} * \text{Width} * \text{Depth})$$

$$\Delta\text{DailyCookingEnergy} = (\text{LB} * \text{EFOOD} / \text{Eff}_{\text{Base}}) - (\text{LB} * \text{EFOOD} / \text{Eff}_{\text{ENERGYSTAR}})$$

$$\text{DailyIdle Energy}_{\text{GasBase}} = [(\text{Idle}_{\text{BaseGas}} * \text{Width} * \text{Depth} * (\text{HOURSday} - (\text{LB}/(\text{PC}_{\text{BaseGas}} * \text{Width} * \text{Depth}) - (\text{PreheatNumber}_{\text{Base}} * \text{PreheatTime}_{\text{Base}}/60)))] - (\text{PreheatNumber}_{\text{Base}} * \text{PreheatTime}_{\text{Base}}/60)$$

$$\text{DailyPreheat Energy}_{\text{GasBase}} = (\text{PreheatNumber}_{\text{Base}} * \text{PreheatTime}_{\text{Base}}/60 * \text{PreheatRate}_{\text{BaseGas}} * \text{Width} * \text{Depth})$$

$$\text{DailyCooking Energy}_{\text{GasBase}} = (\text{LB} * \text{EFOOD} / \text{Eff}_{\text{BaseGas}})$$

$$\text{DailyIdle Energy}_{\text{ElecEE}} = [(\text{Idle}_{\text{ENERGYSTARElec}} * \text{Width} * \text{Depth} * (\text{HOURSday} - (\text{LB}/(\text{PC}_{\text{ENERGYSTARElec}} * \text{Width} * \text{Depth}) - (\text{PreheatNumber}_{\text{ENERGYSTAR}} * \text{PreheatTime}_{\text{ENERGYSTAR}}/60)))] - (\text{PreheatNumber}_{\text{ENERGYSTAR}} * \text{PreheatTime}_{\text{ENERGYSTAR}}/60)$$

$$\text{DailyPreheat Energy}_{\text{ElecEE}} = (\text{PreheatNumber}_{\text{ENERGYSTAR}} * \text{PreheatTime}_{\text{ENERGYSTAR}}/60 * \text{PreheatRate}_{\text{ENERGYSTAR}} * \text{Width} * \text{Depth})$$

$$\text{DailyCooking Energy}_{\text{ElecEE}} = (\text{LB} * \text{EFOOD} / \text{Eff}_{\text{ENERGYSTARElec}})$$

Where:

Idle _{Base}	= Idle energy rate of baseline griddle = Actual or if unknown, use 400 W/h/sq ft for electric and 3,500 Btu/h/sq ft for gas
Idle _{ENERGYSTAR}	= Idle energy rate of ENERGY STAR griddle = Actual or if unknown, use 320 W/h/sq ft for electric and 2,650 Btu/h/sq ft for gas
LB	= Food cooked per day = Actual or if unknown, use 100 pounds
Width	= Griddle Width = Actual or if unknown, use 3 feet
Depth	= Griddle Depth = Actual or if unknown, use 2 feet
PC _{Base}	= Production Capacity base = Actual or if unknown, use 35/6 = 5.83 pounds/hr/sq ft for electric and 25/6 = 4.17 pounds/hr/sq ft for gas
PC _{ENERGYSTAR}	= Production Capacity ENERGY STAR = Actual or if unknown, use 40/6 = 6.67 pounds/hr/sq ft for electric and 45/6 = 7.5 pounds/hr/sq ft for gas
PreheatNumber _{Base}	= Number of preheats per day base = Actual or if unknown, use 1
PreheatNumber _{ENERGYSTAR}	= Number of preheats per day ENERGY STAR = Actual or if unknown, use 1
PreheatTime _{Base}	= preheat length base (mins) = Actual or if unknown, use 15 minutes
PreheatTime _{ENERGYSTAR}	= preheat length ENERGY STAR (mins) = Actual or if unknown, use 15 minutes
PreheatRate _{Base}	= preheat energy rate baseline = Actual or if unknown, use 16000/6 = 2,667 W/sq ft for electric and 84,000/6 = 14,000 btu/h/sq ft
PreheatRate _{ENERGYSTAR}	= preheat energy rate ENERGY STAR = Actual or if unknown, use 8000/6 = 1,333 W/sq ft for electric and 60,000/6 = 10,000 btu/h/sq ft for gas
EFOOD	= ASTM energy to food = 139 w/pound for electric and 475 btu/pound for gas
Eff _{Base}	= Cooking Efficiency Baseline

	= Actual or if unknown, use 65% for electric and 32% for gas
Eff _{ENERGYSTAR}	= Cooking Efficiency ENERGY STAR
	= Actual or if unknown, use 70% for electric and 38% for gas
HOURS _{day}	= Average Daily Operation
	= Actual or if unknown, use 12 hours
Days	= Annual days of operation
	= Actual or if unknown, use 365.25 days a year

For dual fuel griddles, assume that half of the therms savings calculated according to the algorithm above are gas savings and half are electric savings.²⁵⁵ Electric savings for dual griddles should be calculated as $\Delta kWh = (\Delta Therms * 0.50) * 29.3$.

²⁵⁵ Dual fuel griddles are usually electric top plates and gas bottom plates, often used by fast food restaurants. As per DOE workpaper "Energy Savings Potential and RD&D Opportunities for Commercial Building Appliances (2015 Update)" these models have a "second heating plate that is lowered on top of the food and used to simultaneously cook both sides." It therefore is reasonable to assume half savings are attributed to gas v electric.

For example, an ENERGY STAR electric griddle with a tested heavy load cooking energy efficiency of 70 percent and an idle energy rate of 320 W per square foot of cooking surface or less, compared with baseline electric griddle would save:

$$\begin{aligned} \Delta\text{DailyIdleEnergy} &= [400 * 3 * 2 * (12 - (100/(35/6 * 3 * 2)) - (1 * 15/60))] - [320 * 3 * 2 * (12 - (100/(40/6 * 3 * 2)) - (1 * 15/60))] \\ &= 3583 \text{ W} \\ \Delta\text{DailyPreheatEnergy} &= (1 * 15 / 60 * 16000/6 * 3 * 2) - (1 * 15/60 * 8000/6 * 3 * 2) \\ &= 2000\text{W} \\ \Delta\text{DailyCookingEnergy} &= (100 * 139 / 0.65) - (100 * 139 / 0.70) \\ &= 1527 \text{ W} \\ \Delta\text{kWh} &= (2000+1527+3583) * 365.25 /1000 \\ &= 2597 \text{ kWh} \end{aligned}$$

For example, an ENERGY STAR gas griddle with a tested heavy load cooking energy efficiency of 38 percent and an idle energy rate of 2,650 Btu/h per square foot of cooking surface, compared with baseline gas griddle would save:

$$\begin{aligned} \Delta\text{DailyIdleEnergy} &= [3500 * 3 * 2 * (12 - 100/(25/6 * 3 * 2)) - (1 * 15/60)] - [(2650 * 3 * 2 * (12 - (100/(45/6 * 3 * 2)) - (1 * 15/60)))] \\ &= 11,258 \text{ Btu} \\ \Delta\text{DailyPreheatEnergy} &= (1 * 15 / 60 * 14,000 * 3 * 2) - (1 * 15/60 * 10000 * 3 * 2) \\ &= 6,000 \text{ btu} \\ \Delta\text{DailyCookingEnergy} &= (100 * 475/ 0.32) - (100 * 475/ 0.38) \\ &=23,438 \text{ btu} \\ \Delta\text{Therms} &= (11258 + 6000 + 23438) * 365.25 /100000 \\ &=149 \text{ therms} \end{aligned}$$

An ENERGY STAR electric griddle compared to baseline gas griddle assuming default values from above would save.

$$\begin{aligned} \text{SiteEnergySavings (MMBTUs)} &= [\text{GasConsumptionReplaced}] - [\text{ElectricConsumptionAdded}] \\ &= [(\text{DailyIdleEnergy}_{\text{GasBase}} + \text{DailyPreheatEnergy}_{\text{GasBase}} + \text{DailyCookingEnergy}_{\text{GasBase}}) * 1/1,000,000 * \text{Days}] - \\ &\quad [(\text{DailyIdleEnergy}_{\text{ElecEE}} + \text{DailyPreheatEnergy}_{\text{ElecEE}} + \text{DailyCookingEnergy}_{\text{ElecEE}}) * 3.412/1,000,000 * \text{Days}] \end{aligned}$$

$$\begin{aligned} \text{DailyIdleEnergy}_{\text{GasBase}} &= [3500 * 3 * 2 * (12 - 100/(25/6 * 3 * 2)) - (1 * 15/60)] \\ &= 168,000 \text{ btu} \end{aligned}$$

$$\begin{aligned} \text{DailyPreheatEnergy}_{\text{GasBase}} &= (1 * 15 / 60 * 14,000 * 3 * 2) \\ &= 21,000 \text{ btu} \end{aligned}$$

$$\begin{aligned} \text{DailyCookingEnergy}_{\text{GasBase}} &= (100 * 475 / 0.32) \\ &= 148,438 \text{ btu} \end{aligned}$$

$$\begin{aligned} \text{DailyIdleEnergy}_{\text{ElecEE}} &= [320 * 3 * 2 * (12 - (100/(40/6 * 3 * 2)) - (1 * 15/60)) \\ &= 17,760 \text{ Wh} \end{aligned}$$

$$\begin{aligned} \text{DailyPreheatEnergy}_{\text{ElecEE}} &= (1 * 15/60 * 8000/6 * 3 * 2) \\ &= 2,000 \text{ Wh} \end{aligned}$$

$$\begin{aligned} \text{DailyCookingEnergy}_{\text{ElecEE}} &= (100 * 139 / 0.70) \\ &= 19,857 \text{ Wh} \end{aligned}$$

$$\begin{aligned} \text{SiteEnergySavings (MMBTUs)} &= ((168,000 + 21,000 + 148,438) * 1/1,000,000 * 365.25) - \\ &\quad ((17,760 + 2,000 + 19,857) * 3.412/1,000,000 * 365.25) \\ &= 73.9 \text{ MMBtu} \end{aligned}$$

$$\begin{aligned} \text{If supported by an electric utility: } \Delta\text{kWh} &= \Delta\text{SiteEnergySavings} * 1,000,000 / 3,412 \\ &= 73.9 * 1,000,000/3,412 \\ &= 21,659 \text{ kWh} \end{aligned}$$

SUMMER COINCIDENT PEAK DEMAND SAVINGS

Non-fuel switch measures:

$$\text{kW} = (\Delta\text{IdleEnergy} + \Delta\text{PreheatEnergy} + \Delta\text{CookingEnergy}) / (1,000 * \text{HoursDay}) * \text{CF}$$

Fuel switch measures:

$$\text{kW} = - ((\text{DailyIdleEnergy}_{\text{ElecEE}} + \text{DailyPreheatEnergy}_{\text{ElecEE}} + \text{DailyCookingEnergy}_{\text{ElecEE}}) / (1,000 * \text{HoursDay}) * \text{CF}$$

Where:

$$\text{CF} = \text{Summer Peak Coincidence Factor}$$

$$= 0.90^{256}$$

For example, an ENERGY STAR griddle in a cafeteria with a tested heavy load cooking energy efficiency of 70 percent or greater and an idle energy rate of 320 W per square foot of cooking surface or less would save

$$= (2000+1527+3583)/(1000 * 12) * 0.9$$

$$= 0.533 \text{ kW}$$

FOSSIL FUEL SAVINGS

Calculation provided together with Electric Energy Savings above.

WATER IMPACT DESCRIPTIONS AND CALCULATION

N/A

DEEMED O&M COST ADJUSTMENT CALCULATION

N/A

COST EFFECTIVENESS SCREENING AND LOAD REDUCTION FORECASTING WHEN FUEL SWITCHING

This measure can involve fuel switching from fossil fuel to electric.

For the purposes of forecasting load reductions due to fuel switch projects per Section 16-111.5B, changes in site energy use at the customer’s meter (using ΔkWh algorithm below), customer switching estimates, NTG, and any other adjustment factors deemed appropriate, should be used.

The inputs to cost effectiveness screening should reflect the actual impacts on the electric and fuel consumption at the customer meter and, for fuel switching measures, should therefore reflect the decrease in one fuel and increase in another, as opposed to the single savings value calculated in the “Electric and Fossil Fuel Energy Savings” section above. Therefore in addition to the calculation of savings claimed, the following values should be used to assess the cost effectiveness of the measure.

$$\Delta\text{Therms} = [\text{Gas Cooking Consumption Replaced}]$$

$$= [(\text{DailyIdleEnergy}_{\text{GasBase}} + \text{DailyPreheatEnergy}_{\text{GasBase}} + \text{DailyCookingEnergy}_{\text{GasBase}}) * 1/100,000 * \text{Days}]$$

$$\Delta\text{kWh} = [\text{Electric Cooking Consumption Added}]$$

$$= - [(\text{DailyIdleEnergy}_{\text{ElecEE}} + \text{DailyPreheatEnergy}_{\text{ElecEE}} + \text{DailyCookingEnergy}_{\text{ElecEE}}) * \text{Days} / 1,000]$$

MEASURE CODE: CI-FSE-ESGR-V07-250101

REVIEW DEADLINE: 1/1/2028

²⁵⁶ Itron, Inc. 2005. 2004-2005 Database for Energy Efficiency Resources (DEER) Update Study - Final Report. Prepared for Southern California Edison.

4.2.9 ENERGY STAR Hot Food Holding Cabinets

DESCRIPTION

This measure applies to electric ENERGY STAR hot food holding cabinets (HFHC) installed in a commercial kitchen.

This measure was developed to be applicable to the following program types: TOS. If applied to other program types, the measure savings should be verified.

DEFINITION OF EFFICIENT EQUIPMENT

To qualify for this measure the installed equipment must be an ENERGY STAR certified HFHC.

DEFINITION OF BASELINE EQUIPMENT

The baseline equipment is an electric HFHC that’s not ENERGY STAR certified and at end of life.

DEEMED LIFETIME OF EFFICIENT EQUIPMENT

The expected measure life is assumed to be 12 years.²⁵⁷

DEEMED MEASURE COST

The incremental capital cost for this measure is \$1,000.²⁵⁸

LOADSHAPE

Loadshape C01 - Commercial Electric Cooking

COINCIDENCE FACTOR

Summer Peak Coincidence Factor for measure is assumed to be 0.90.²⁵⁹

Algorithm

CALCULATION OF SAVINGS

ELECTRIC ENERGY SAVINGS

Custom calculation below, otherwise use deemed values of 545 kWh.²⁶⁰

$$\Delta \text{kWh} = (\text{IdleEnergyRateBase} - \text{IdleEnergyRateES}) * \text{HOURSday} * \text{Days}/1000$$

Where:

IdleEnergyRateBase	= Custom, otherwise = 30 * V
V	= Volume of HFHC (cubic feet) = Custom, otherwise assume 15 cu ft
HOURSday	= Average Daily Operation = custom or if unknown, use 9 hours

²⁵⁷ Lifetime from ENERGY STAR Commercial Kitchen Equipment Calculator, Hot Food Holding Cabinet Calculations, which cites reference as “FSTC research on available models, 2009”.

²⁵⁸ Measure cost from ENERGY STAR Commercial Kitchen Equipment Calculator, published 2021, which cites reference as “EPA research using AutoQuotes, 2020”.

²⁵⁹ Itron, Inc. 2005. 2004-2005 Database for Energy Efficiency Resources (DEER) Update Study - Final Report. Prepared for Southern California Edison.

²⁶⁰ Algorithms and assumptions derived from ENERGY STAR Commercial Kitchen Equipment Savings Calculator, published 2021.

Days = Annual days of operation
 = custom or if unknown, use 365 days a year

IdleEnergyRateES = Custom, otherwise assume maximum ENERGY STAR Idle Energy Rate presented below. If volume is unknown assume 15 cu ft, resulting in 284W:

Cabinet Volume (cu ft)	Power (W)
$V < 13$	$21.5 * V$
$13 \leq V < 28$	$2 * V + 254$
$28 \leq V$	$3.8 * V + 203.5$

For example, if a full size HFHC, with a volume of 15 cubic ft, is installed the measure would save:

$$\begin{aligned} \Delta kWh &= ((15 * 30) - (2 * V + 254)) * 9 * 365 / 1,000 \\ &= (450 - 284) * 9 * 365 / 1,000 \\ &= 545 kWh \end{aligned}$$

SUMMER COINCIDENT PEAK DEMAND SAVINGS

$$\Delta kW = \Delta kWh / \text{Hours} * CF$$

Where:

Hours = Hoursday * Days
 = If unknown, use 9 * 365 = 3285 hours

CF = Summer Peak Coincidence Factor
 = 0.90²⁶¹

For example, if a full size HFHC, with a volume of 15 cubic feet, is installed in a cafeteria the measure would save:

$$\begin{aligned} &= 545 kWh / (9 * 365) * 0.9 \\ &= 0.1493 kW \end{aligned}$$

FOSSIL FUEL SAVINGS

N/A

WATER IMPACT DESCRIPTIONS AND CALCULATION

N/A

DEEMED O&M COST ADJUSTMENT CALCULATION

N/A

MEASURE CODE: CI-FSE-ESHH-V05-250101

REVIEW DEADLINE: 1/1/2026

²⁶¹ Itron, Inc. 2005. 2004-2005 Database for Energy Efficiency Resources (DEER) Update Study - Final Report. Prepared for Southern California Edison.

4.2.10 Ice Maker

DESCRIPTION

This measure relates to the installation of a new ENERGY STAR qualified commercial ice machine. The ENERGY STAR label applied to air-cooled, cube-type machines including ice-making head, self-contained, and remote-condensing units. This measure could relate to the replacing of an existing unit at the end of its useful life, or the installation of a new system in a new or existing building.

This measure was developed to be applicable to the following program types: TOS and NC. If applied to other program types, the measure savings should be verified.

DEFINITION OF EFFICIENT EQUIPMENT

In order for this characterization to apply, the efficient equipment is assumed to be a new commercial ice machine meeting the minimum ENERGY STAR efficiency level standards.

ENERGY STAR Requirements (Version 3.0, Effective January 28, 2018)

ENERGY STAR Requirements for Air-Cooled Batch-Type Ice Makers			
Equipment Type	Applicable Ice Harvest Rate Range (lbs of ice/24 hrs)	ENERGY STAR Energy Consumption Rate (kWh/100 lbs ice)	Potable Water Use (gal/100 lbs ice)
IMH	H < 300	≤ 9.20 - 0.01134H	≤ 20.0
	300 ≤ H < 800	≤ 6.49 - 0.0023H	
	800 ≤ H < 1500	≤ 5.11 - 0.00058H	
	1500 ≤ H ≤ 4000	≤ 4.24	
RCU	H < 988	≤ 7.17 – 0.00308H	≤ 20.0
	988 ≤ H ≤ 4000	≤ 4.13	
SCU	H < 110	≤ 12.57 - 0.0399H	≤ 25.0
	110 ≤ H < 200	≤ 10.56 - 0.0215H	
	200 ≤ H ≤ 4000	≤ 6.25	
ENERGY STAR Requirements for Air-Cooled Continuous-Type Ice Makers			
Equipment Type	Applicable Ice Harvest Rate Range (lbs of ice/24 hrs)	ENERGY STAR Energy Consumption Rate (kWh/100 lbs ice)	Potable Water Use (gal/100 lbs ice)
IMH	H < 310	≤ 7.90 – 0.005409H	≤ 15.0
	310 ≤ H < 820	≤ 7.08 – 0.002752H	
	820 ≤ H ≤ 4000	≤ 4.82	
RCU	H < 800	≤ 7.76 – 0.00464H	≤ 15.0
	800 ≤ H ≤ 4000	≤ 4.05	
SCU	H < 200	≤ 12.37 – 0.0261H	≤ 15.0
	200 ≤ H < 700	≤ 8.24 – 0.005429H	
	700 ≤ H ≤ 4000	≤ 4.44	

DEFINITION OF BASELINE EQUIPMENT

In order for this characterization to apply, the baseline equipment is assumed to be a commercial ice machine meeting federal equipment standards established January 28, 2018.

DEEMED LIFETIME OF EFFICIENT EQUIPMENT

The expected measure life is assumed to be 9 years.²⁶²

DEEMED MEASURE COST

When available, the actual cost of the measure installation and equipment shall be used. The incremental capital cost for this measure is \$0 for Batch-Type and Continuous-Type²⁶³.

LOADSHAPE

Loadshape C23 - Commercial Refrigeration

COINCIDENCE FACTOR

The Summer Peak Coincidence Factor is assumed to equal 0.937.

Algorithm

CALCULATION OF SAVINGS

ELECTRIC ENERGY SAVINGS

$$\Delta \text{kWh} = [(\text{kWh}_{\text{base}} - \text{kWh}_{\text{ee}}) / 100] * (\text{DC} * \text{H}) * 365.25$$

Where:

kWh_{base} = maximum kWh consumption per 100 pounds of ice for the baseline equipment
= calculated as shown in the table below using the actual Harvest Rate (H) of the efficient equipment²⁶⁴.

kWh_{ee} = maximum kWh consumption per 100 pounds of ice for the efficient equipment
= actual if known. If unknown calculate as shown in the table below using the actual Harvest Rate (H) of the efficient equipment.

²⁶² Based on DOE Technical Support Document, 2014 as recommended in Navigant 'ComEd Effective Useful Life Research Report', May 2018.

²⁶³ Incremental costs from ENERGY STAR Commercial Kitchen Equipment Savings Calculator. Calculator cites EPA research using AutoQuotes, 2016.

²⁶⁴ Use the appropriate equipment type baseline and ice harvest rate range when calculating the savings for a CEE Tier Advanced ice maker.

Energy Consumption of Air-Cooled Batch-Type Ice Makers			
Ice Maker Type	Applicable Ice Harvest Rate Range (lbs of ice/24 hrs)	kWh _{Base}	kWh _{ESTAR}
IMH	H < 300	10-0.01233H	≤ 9.20 - 0.01134H
	300 ≤ H < 800	7.05-0.0025H	≤ 6.49 - 0.0023H
	800 ≤ H < 1500	5.55-0.00063H	≤ 5.11 - 0.00058H
	1500 ≤ H ≤ 4000	4.61	≤ 4.24
RCU	H < 988	7.97-0.00342H	≤ 7.17 – 0.00308H
	988 ≤ H ≤ 4000	4.59	≤ 4.13
SCU	H < 110	14.79-0.0469H	≤ 12.57 - 0.0399H
	110 ≤ H < 200	12.42-0.02533H	≤ 10.56 - 0.0215H
	200 ≤ H ≤ 4000	7.35	≤ 6.25
Energy Consumption of Air-Cooled Continuous-Type Ice Makers			
Equipment Type	Applicable Ice Harvest Rate Range (lbs of ice/24 hrs)	kWh _{Base}	kWh _{ESTAR}
IMH	H < 310	9.19-0.00629H	≤ 7.90 – 0.005409H
	310 ≤ H < 820	8.23-0.0032H	≤ 7.08 – 0.002752H
	820 ≤ H ≤ 4000	5.61	≤ 4.82
RCU	H < 800	9.7-0.0058H	≤ 7.76 – 0.00464H
	800 ≤ H ≤ 4000	5.06	≤ 4.05
SCU	H < 200	14.22-0.03H	≤ 12.37 – 0.0261H
	200 ≤ H < 700	9.47-0.00624H	≤ 8.24 – 0.005429H
	700 ≤ H ≤ 4000	5.1	≤ 4.44

100 = conversion factor to convert kWh_{base} and kWh_{est} into maximum kWh consumption per pound of ice.

DC = Duty Cycle of the ice machine
= 0.57²⁶⁵

H = Harvest Rate (pounds of ice made per day)
= Actual installed

365.35 = days per year

For example, a batch ice machine with an ice making head producing 450 pounds of ice would save

$$\begin{aligned} \Delta \text{kWh} &= [(5.9 - 5.5) / 100] * (0.57 * 450) * 365.25 \\ &= 440 \text{ kWh} \end{aligned}$$

²⁶⁵Duty cycle varies considerably from one installation to the next. TRM assumptions from Vermont, Wisconsin, and New York vary from 40 to 57%, whereas the ENERGY STAR Commercial Ice Machine Savings Calculator assumes a value of 75%. A field study of eight ice machines in California indicated an average duty cycle of 57% (“A Field Study to Characterize Water and Energy Use of Commercial Ice-Cube Machines and Quantify Saving Potential”, Food Service Technology Center, December 2007). Furthermore, a report prepared by ACEEE assumed a value of 40% (Nadel, S., Packaged Commercial Refrigeration Equipment: A Briefing Report for Program Planners and Implementers, ACEEE, December 2002). The value of 57% was utilized since it appears to represent a high quality data source.

SUMMER COINCIDENT PEAK DEMAND SAVINGS

$$\Delta kW = \Delta kWh / (\text{HOURS} * DC) * CF$$

Where:

HOURS = annual operating hours

$$= 8766^{266}$$

CF = 0.937

For example, an ice machine with an ice making head producing 450 pounds of ice would save

$$\Delta kW = 440 / (8766 * 0.57) * .937$$

$$= 0.083 \text{ kW}$$

FOSSIL FUEL SAVINGS

N/A

WATER IMPACT DESCRIPTIONS AND CALCULATION

While the ENERGY STAR labeling criteria require that certified commercial ice machines meet certain “maximum potable water use per 100 pounds of ice made” requirements, such requirements are intended to prevent equipment manufacturers from gaining energy efficiency at the cost of water consumptions. A review of the AHRI Certification Directory²⁶⁷ indicates that approximately 81% of air-cooled, cube-type machines meet the ENERGY STAR potable water use requirement. Therefore, there are no assumed water impacts for this measure.

DEEMED O&M COST ADJUSTMENT CALCULATION

N/A

MEASURE CODE: CI-FSE-ESIM-V07-240101

REVIEW DEADLINE: 1/1/2027

²⁶⁶Unit is assumed to be connected to power 24 hours per day, 365.25 days per year.

²⁶⁷AHRI Certification Directory, Automatic Commercial Ice Makers, Accessed on 7/7/10.

4.2.11 High Efficiency Pre-Rinse Spray Valve

DESCRIPTION

Pre-rinse spray valves use a spray of water to remove food waste from dishes prior to cleaning in a dishwasher. More efficient spray valves use less water thereby reducing water consumption, water heating cost, and waste water (sewer) charges. Pre-rinse spray valves include a nozzle, squeeze lever, and dish guard bumper. Pre-rinse spray valves are manually operated, and the frequency of use depends on the volume of dirty dishes washed at a facility. The primary impacts of this measure are water savings. Reduced hot water consumption saves either natural gas or electricity, depending on the type of energy the hot water heater uses.

This measure was developed to be applicable to the following program types: TOS, EREP, KITS and DI. If applied to other program types, the measure savings should be verified.

DEFINITION OF EFFICIENT EQUIPMENT

To qualify for this measure, the new or replacement pre-rinse spray nozzle must have a maximum flow rate that meets program requirements.

DEFINITION OF BASELINE EQUIPMENT

The baseline equipment flow rate depends on program type. For TOS, the baseline equipment is a new pre-rinse spray valve with a maximum flow rate of 1.23 gpm or less.²⁶⁸ For EREP and DI, the baseline equipment is an existing pre-rinse spray valve with an assumed flow rate of 2.14 gpm or less.²⁶⁹

DEEMED LIFETIME OF EFFICIENT EQUIPMENT

The expected measure life is assumed to be 5 years.²⁷⁰

DEEMED MEASURE COST

When available, the actual cost of the measure (including labor where applicable) should be used. If unknown, the incremental cost of this measure for TOS programs is assumed to be \$0.²⁷¹ For EREP, KITS and DI programs, the total installed cost is assumed to be \$54.²⁷²

LOADSHAPE

Loadshape C01 - Commercial Electric Cooking

COINCIDENCE FACTOR

N/A

²⁶⁸ Baseline for TOS programs is calculated using the maximum flow rate for each product class in 10 CFR 431.266, Energy Efficiency Program for Certain Commercial and Industrial Equipment weighted by estimated 2018 shipments for each product class from Table 3.6.1: U.S. DOE, "Technical Support Document: Energy Efficiency Program for Consumer Products and Commercial and Industrial Equipment: Commercial Prerinse Spray Valves," December 2015.

²⁶⁹ Average flow rate of spray valve replaced through direct install programs from DNV-GL, "Impact Evaluation of National Grid Rhode Island C&I Prescriptive Gas Pre-Rinse Spray Valve Measure – Final Report," September 30, 2014, page 6-6.

²⁷⁰ Measure life from U.S. DOE, "Technical Support Document: Energy Efficiency Program for Consumer Products and Commercial and Industrial Equipment: Commercial Prerinse Spray Valves," December 2015, page 8-13."

²⁷¹ Incremental measure cost based on U.S. DOE, "Technical Support Document: Energy Efficiency Program for Consumer Products and Commercial and Industrial Equipment: Commercial Prerinse Spray Valves," December 2015, page 8-1.

²⁷² Total installed cost is the manufacturer selling price (\$35.40) from Table 8.2.1 multiplied by the retailer markup (1.52) from Table 8.2.2: U.S. DOE, "Technical Support Document: Energy Efficiency Program for Consumer Products and Commercial and Industrial Equipment: Commercial Prerinse Spray Valves," December 2015. It is assumed that programs typically install spray valves only when other kitchen equipment is also being installed, and therefore, there are no additional labor costs associated with spray valve installations.

Algorithm

CALCULATION OF ENERGY SAVINGS

ELECTRIC ENERGY SAVINGS (NOTE WATER SAVINGS MUST FIRST BE CALCULATED)

$$\Delta kWH = \Delta Water \text{ (gallons)} * 8.33 * 1 * (Tout - Tin) * (1/EFF_Elec) / 3,412 * FLAG$$

Where:

- $\Delta Water$ (gallons) = amount of water saved as calculated below
- 8.33 = specific mass in pounds of one gallon of water (lbm/gal)
- 1 = Specific heat of water: 1 Btu/lbm/°F
- Tout = Water Heater Outlet Water Temperature
= custom, otherwise assume Tin + 70°F temperature rise from Tin²⁷³
- Tin = Inlet Water Temperature
= custom, otherwise assume 50.7°F²⁷⁴
- EFF_Elec = Efficiency of electric water heater supplying hot water to pre-rinse spray valve
= custom, otherwise assume 98%²⁷⁵
- Flag = 1 if electric or 0 if gas

Time of Sale: For example, a new spray nozzle with 0.98 gal/min flow replacing a nozzle with 1.23 gal/min flow at a large institutional establishments with a cafeteria with 70 degree temperature rise of water used by the pre-rinse spray valve that is heated by electric hot water saves annually :

$$\begin{aligned} \Delta kWH &= 14,040 * 8.33 * 1 * ((70+50.7) - 50.7) * (1/.98) / 3,412 * 1 \\ &= 2,448kWh \end{aligned}$$

Retrofit: For example, a new spray nozzle with 0.98 gal/min flow replacing a nozzle with 2.14 gal/min flow at a large institutional establishments with a cafeteria with 70 degree temperature rise of water used by the pre-rinse spray valve that is heated by electric hot water equals:

$$\begin{aligned} \Delta kWH &= 65,146 * 8.33 * 1 * ((70+ 50.7) - 50.7) * (1/.98) / 3,412 * 1 \\ &= 11,360 kWh \end{aligned}$$

Secondary kWh Savings for Water Supply and Wastewater Treatment

The following savings should be included in the total savings for this measure, but should not be included in TRC tests to avoid double counting the economic benefit of water savings.

$$\Delta kWh_{water} = \Delta Water \text{ (gallons)} / 1,000,000 * E_{water \text{ total}}$$

Where:

- $E_{water \text{ total}}$ = IL Total Water Energy Factor (kWh/Million Gallons)

²⁷³If unknown, assume a 70 degree temperature rise from Tin per Food Service Technology Center calculator assumptions to account for variations in mixing and water heater efficiencies.

²⁷⁴ Table 4 in Chen, et. al., "Calculating Average Hot Water Mixes of Residential Plumbing Fixtures", June 2020, reports a value of 50.7°F for inlet water temperature for U.S. Census Division 3.

²⁷⁵ Electric water heaters have recovery efficiency of 98%, as sourced from available products on the AHRI Certification Directory.

$$=5,010^{276}$$

Time of Sale: For example, a new spray nozzle with 0.98 gal/min flow replacing a nozzle with 1.23 gal/min flow at a large institutional establishment with a cafeteria equals

$$\begin{aligned} \Delta\text{Water (gallons)} &= (1.23 - 0.98) * 60 * 3 * 312 \\ &= 14,040 \text{ gal/yr} \\ \Delta\text{kWh}_{\text{water}} &= 14,040/1,000,000*5,010 \\ &= 70 \text{ kWh} \end{aligned}$$

SUMMER COINCIDENT PEAK DEMAND SAVINGS

N/A

FOSSIL FUEL SAVINGS

$$\Delta\text{Therms} = \Delta\text{Water (gallons)} * 8.33 * 1 * (\text{Tout} - \text{Tin}) * (1/\text{EFF}_{\text{Gas}}) / 100,000 * (1 - \text{FLAG})$$

Where (new variables only):

$$\begin{aligned} \text{EFF}_{\text{Gas}} &= \text{Efficiency of gas water heater supplying hot water to pre-rinse spray valve} \\ &= \text{custom, otherwise assume } 80\%^{277} \end{aligned}$$

Time of Sale: For example, a new spray nozzle with 0.98 gal/min flow replacing a nozzle with 1.23 gal/min flow at a large institutional establishments with a cafeteria with 70 degree temperature of water used by the pre-rinse spray valve that is heated by fossil fuel hot water saves annually:

$$\begin{aligned} \Delta\text{Therms} &= 14,040 * 8.33 * 1 * ((70+50.7) - 50.7) * (1/0.80)/100,000 * (1-0) \\ &= 102 \text{ Therms} \end{aligned}$$

Retrofit: For example, a new spray nozzle with 0.98 gal/min flow replacing a nozzle with 2.14 gal/min flow at a busy large institutional establishments with a cafeteria with 70 degree temperature rise of water used by the pre-rinse spray valve that is heated by fossil fuel hot water saves annually:

$$\begin{aligned} \Delta\text{Therms} &= 65,146 * 8.33 * 1 * ((70+50.7) - 50.7) * (1/0.80)/100,000 * (1-0) \\ &= 475 \text{ Therms} \end{aligned}$$

WATER IMPACT CALCULATION²⁷⁸

$$\Delta\text{Water (gallons)} = (\text{FLO}_{\text{base}} - \text{FLO}_{\text{eff}}) * 60 * \text{HOURS}_{\text{day}} * \text{DAYS}_{\text{year}} * \text{ISR}$$

Where:

$$\text{FLO}_{\text{base}} = \text{Base case flow in gallons per minute, or custom (Gal/min)}$$

²⁷⁶ This factor include 2571 kWh/MG for water supply based on Illinois energy intensity data from a 2012 ISAWWA study and 2439 kWh/MG for wastewater treatment based on national energy intensity use estimates. For more information please review Elevate Energy’s ‘IL TRM: Energy per Gallon Factor, May 2018 paper’.

²⁷⁷ IECC 2015, Table C404.2, Minimum Performance of Water-Heating Equipment

²⁷⁸In order to calculate energy savings, water savings must first be calculated

Time of Sale	Direct Install
1.23 gal/min ²⁷⁹	2.14 gal/min ²⁸⁰

FLO_{eff} = Efficient case flow in gallons per minute or custom (Gal/min)
 = 0.98 gal/min²⁸¹

60 = Minutes per hour

HOURS_{day} = Hours per day that the pre-rinse spray valve is used at the site, custom, otherwise:²⁸²

Application	Hours/day
Small, quick- service restaurants	1
Medium-sized casual dining restaurants	1.5
Large institutional establishments with cafeteria	3

DAYS_{year} = Days per year pre-rinse spray valve is used at the site, custom, otherwise 312 days/yr based on assumed 6 days/wk x 52 wk/yr = 312 day/yr.

ISR = in-service-rate, the percentage of units actually installed. For kits programs, if survey data is unavailable, use 0.466²⁸³. For all other programs use 1.0.

Time of Sale: For example, a new spray nozzle with 0.98 gal/min flow replacing a nozzle with 1.23 gal/min flow at a large institutional establishment with a cafeteria equals

$$= (1.23 - 0.98) * 60 * 3 * 312$$

$$= 14,040 \text{ gal/yr}$$

Retrofit: For example, a new spray nozzle with 0.98 gal/min flow replacing a nozzle with 2.14 gal/min flow at a large institutional establishments with a cafeteria equals

$$= (2.14 - 0.98) * 60 * 3 * 312$$

$$= 65,146 \text{ gal/yr}$$

DEEMED O&M COST ADJUSTMENT CALCULATION

N/A

²⁷⁹Baseline for TOS programs is calculated using the maximum flow rate for each product class in 10 CFR 431.266, Energy Efficiency Program for Certain Commercial and Industrial Equipment weighted by estimated 2018 shipments for each product class from Table 3.6.1: U.S. DOE, “Technical Support Document: Energy Efficiency Program for Consumer Products and Commercial and Industrial Equipment: Commercial Prerinse Spray Valves,” December 2015.

²⁸⁰ Average flow rate of spray valve replaced through direct install programs from DNV-GL, “Impact Evaluation of National Grid Rhode Island C&I Prescriptive Gas Pre-Rinse Spray Valve Measure – Final Report,” September 30, 2014, page 6-6.

²⁸¹ A new pre-rinse spray valve is assumed to be 20% more efficient than the federal standard.

²⁸² Hours primarily based on PG& E savings estimates, algorithms, sources (2005), Food Service Pre-Rinse Spray Valves with review of 2010 Ohio Technical Reference Manual and Act on Energy Business Program Technical Resource Manual Rev05.

²⁸³ Average ISR for pre-rinse spray valves distributed to ComEd Small Business Kit customers in CY2018, CY2019, and CY2020. ISR was calculated based on 262 telephone surveys from restaurant and fire station participants. Please see file “SB Kits Survey Analysis TRMv10 Support.xlsx”

MEASURE CODE: CI-FSE-SPRY-V08-220101

REVIEW DEADLINE: 1/1/2026

4.2.12 Infrared Charbroiler

DESCRIPTION

This measure applies to natural gas fired charbroilers that utilize infrared burners installed in a commercial kitchen. This measure was developed to be applicable to the following program types: TOS. If applied to other program types, the measure savings should be verified.

DEFINITION OF EFFICIENT EQUIPMENT

To qualify for this measure the installed equipment must be a new natural gas charbroiler with infrared burners.

DEFINITION OF BASELINE EQUIPMENT

The baseline equipment is an existing natural gas charbroiler without infrared burners.

DEEMED LIFETIME OF EFFICIENT EQUIPMENT

The expected measure life is assumed to be 12 years.²⁸⁴

DEEMED MEASURE COST

The incremental capital cost for this measure is \$2173.²⁸⁵

LOADSHAPE

N/A

COINCIDENCE FACTOR

N/A

Algorithm

CALCULATION OF SAVINGS

ELECTRIC ENERGY SAVINGS

N/A

SUMMER COINCIDENT PEAK DEMAND SAVINGS

N/A

FOSSIL FUEL SAVINGS

Custom calculation below, otherwise use deemed value of 707 therms based on default values.²⁸⁶

$$\Delta Therms = \frac{(\Delta PreheatEnergy + \Delta CookingEnergy) * Days}{100,000}$$

$$\Delta PreheatEnergy = (PreheatRate_{Base} - PreheatRate_{EE}) * Preheats * \frac{PreheatTime}{60}$$

$$\Delta CookingEnergy = (InputRate_{Base} - InputRate_{EE}) * (Duty * Hours)$$

Where:

²⁸⁴ Lifecycle determined from Food Service Technology Center Gas Broiler Life-Cycle Cost Calculator and from FSTC Broiler Technology Assessment.

²⁸⁵ See 'Arkansas Deemed TRM Table for GasFoodService.xls' from v3.0 Arkansas Technical Reference Manual.

²⁸⁶ Assumptions derived from Food Service Technology Center Gas Broiler Life-Cycle Cost Calculator and from FSTC Broiler Technology Assessment, Section 4: Broilers.

Days	= Annual days of operation = Custom or if unknown, use 312 days per year ²⁸⁷
100,000	= Btu to therms conversion factor
PreheatRate _{Base}	= Preheat energy rate of baseline charbroiler = 64,000 Btu/hr
PreheatRate _{EE}	= Preheat energy rate of infrared charbroiler = Custom or if unknown, use 54,000 Btu/hr
Preheats	= Number of preheats per day = Custom or if unknown, use 1 preheat per day
PreheatTime	= Length of one preheat = Custom or if unknown, use 15 minutes per preheat ²⁸⁸
60	= Minutes to hours conversion factor
InputRate _{Base}	= Input energy rate of baseline charbroiler = 140,000 Btu/hr
InputRate _{EE}	= Input energy rate of infrared charbroiler = Custom or if unknown, use 105,000 Btu/hr
Duty	= Duty cycle of charbroiler (%) = Custom or if unknown, use 80% ²⁸⁹
Hours	= Average daily hours of operation = Custom or if unknown, use 8 hours per day

For example, using the default assumptions on the installation of an infrared charbroiler:

$$\begin{aligned}
 \text{PreheatEnergy} &= (64,000 - 54,000) * 1 * (15 / 60) \\
 &= 2500 \text{ BTU/day} \\
 \text{CookingEnergy} &= (140,000 - 105,000) * (.80 * 8) \\
 &= 224,000 \text{ BTU/day} \\
 \Delta\text{Therms} &= ((2,500 + 224,000) * 312) / 100,000 \\
 &= 706.7 \text{ Therms}
 \end{aligned}$$

WATER IMPACT DESCRIPTIONS AND CALCULATION

N/A

DEEMED O&M COST ADJUSTMENT CALCULATION

N/A

²⁸⁷Typical annual operating time from FSTC Broiler Technology Assessment, Table 4.3.

²⁸⁸Typical preheat time from FSTC Broiler Technology Assessment.

²⁸⁹ Duty cycle from FSTC Broiler Technology Assessment, Table 4.3.

MEASURE CODE: CI-FSE-IRCB-V04-250101

REVIEW DEADLINE: 1/1/2028

4.2.13 Rotisserie Oven

DESCRIPTION

This measure applies to efficient natural gas fired high efficiency rotisserie ovens utilizing infrared burners or design approaches that combine radiative heat exchangers and convection heating and installed in a commercial kitchen.

This measure was developed to be applicable to the following program types: TOS. If applied to other program types, the measure savings should be verified.

DEFINITION OF EFFICIENT EQUIPMENT

To qualify for this measure the installed equipment must be a new highly efficient natural gas rotisserie oven as defined by the program.

DEFINITION OF BASELINE EQUIPMENT

The baseline equipment is a new standard natural gas rotisserie oven.

DEEMED LIFETIME OF EFFICIENT EQUIPMENT

The expected measure life is assumed to be 12 years.²⁹⁰

DEEMED MEASURE COST

The incremental capital cost for this measure is \$2665.²⁹¹

LOADSHAPE

N/A

COINCIDENCE FACTOR

N/A

Algorithm

CALCULATION OF SAVINGS

ELECTRIC ENERGY SAVINGS

N/A

SUMMER COINCIDENT PEAK DEMAND SAVINGS

N/A

FOSSIL FUEL SAVINGS

Custom calculation below based on Food Service Technology Center calculator, otherwise use deemed value of 599 therms, based on default values.

$$\Delta Therms = \frac{(InputRate_{Base} - InputRate_{EE}) * Duty * Days * HoursDay}{100,000}$$

Where:

- InputRate_{Base} = Energy input rate of baseline rotisserie oven (Btu/hr)
- = Custom of if unknown, use 90,000 Btu/hr²⁹²

²⁹⁰Lifecycle determined from Food Service Technology Center Gas Oven Life-Cycle Cost Calculator.

²⁹¹See 'Arkansas Deemed TRM Table for GasFoodService.xls' from v3.0 Arkansas Technical Reference Manual.

²⁹² Median rated energy input for rotisserie ovens from FSTC Oven Technology Assessment, Section 7: Ovens, Table 7.2.

- InputRate_{EE} = Energy input rate of efficient rotisserie oven (Btu/hr)
= Custom of if unknown, use 50,000 Btu/hr²⁹³
- Duty = Duty cycle of rotisserie oven (%)
= Custom or if unknown, use 60%²⁹⁴
- Days = Days per year rotisserie oven is operating
= Custom of if unknown assume 312 (6 days a week, 52 weeks per year) ²⁹⁵
- HoursDay = Typical daily operating hours of rotisserie oven
= Custom or if unknown, assume 8 hours²⁹⁶
- 100,000 = Btu to therms conversion factor

WATER IMPACT DESCRIPTIONS AND CALCULATION

N/A

DEEMED O&M COST ADJUSTMENT CALCULATION

N/A

MEASURE CODE: CI-FSE-IROV-V04-240101

REVIEW DEADLINE: 1/1/2027

²⁹³ Infrared energy input rate calculated based on efficient energy input rate of 50,000 Btu/hr, baseline cooking efficiency of 25%, and infrared cooking efficiency of 45%. Efficiencies and rates derived from FSTC Gas Rotisserie Oven Test Reports and FSTC Oven Technology Assessment.

²⁹⁴ Duty cycle from Food Service Technology Center Oven Technical Assessment, Table 7.2.

²⁹⁵ Typical operating hours based on oven operating schedule of 8 hours per day, 6 days per week, 52 weeks per year, provided in Food Service Technology Center Oven Technical Assessment, Table 7.2.

²⁹⁶ Food Service Technology Center Oven Technical Assessment, Table 7.2.

4.2.14 Infrared Salamander Broiler

DESCRIPTION

This measure applies to natural gas fired high efficiency salamander broilers utilizing infrared burners installed in a commercial kitchen.

This measure was developed to be applicable to the following program types: TOS. If applied to other program types, the measure savings should be verified.

DEFINITION OF EFFICIENT EQUIPMENT

To qualify for this measure the installed equipment must be a new natural gas salamander broiler with infrared burners

DEFINITION OF BASELINE EQUIPMENT

The baseline equipment is an existing natural gas salamander broiler without infrared burners

DEEMED LIFETIME OF EFFICIENT EQUIPMENT

The expected measure life is assumed to be 12 years.²⁹⁷

DEEMED MEASURE COST

The incremental capital cost for this measure is \$1,000.²⁹⁸

LOADSHAPE

N/A

COINCIDENCE FACTOR

N/A

Algorithm

CALCULATION OF SAVINGS

ELECTRIC ENERGY SAVINGS

N/A

SUMMER COINCIDENT PEAK DEMAND SAVINGS

N/A

FOSSIL FUEL SAVINGS

Custom calculation below based on Food Service Technology Center calculator, otherwise use deemed value of 240 therms, based on defaults.

$$\Delta Therms = \frac{(InputRate_{Base} - InputRate_{EE}) * Duty * Days * HoursDay}{100,000}$$

Where:

InputRate_{Base} = Rated energy input rate of baseline salamander broiler (Btu/hr)
 = 38,500 Btu/hr²⁹⁹

²⁹⁷ Lifecycle determined from Food Service Technology Center Gas Broiler Life-Cycle Cost Calculator and from FSTC Broiler Technology Assessment.

²⁹⁸See 'Arkansas Deemed TRM Table for GasFoodService.xls' from v3.0 Arkansas Technical Reference Manual.

²⁹⁹ Median rated energy input for salamander broilers from FSTC Broiler Technology Assessment, Section 4: Broilers, Table 4.3.

InputRate _{EE}	= Rated energy input rate of infrared salamander broiler (Btu/hr) = Custom; or if unknown, use 24,750 Btu/hr ³⁰⁰
Duty	= Duty cycle of salamander broiler (%) = Custom; or if unknown, use 70% ³⁰¹
Days	= Days per year salamander broiler is operating = Custom of if unknown assume 312 (6 days a week, 52 weeks per year) ³⁰²
HoursDay	= Typical daily operating hours of salamander broiler = Custom; or if unknown, assume 8 hours ³⁰³
100,000	= Btu to therms conversion factor

WATER IMPACT DESCRIPTIONS AND CALCULATION

N/A

DEEMED O&M COST ADJUSTMENT CALCULATION

N/A

MEASURE CODE: CI-FSE-IRBL-V03-240101

REVIEW DEADLINE: 1/1/2028

³⁰⁰ Calculated energy input rate based on baseline energy input rate of 38,500 Btu/hr, baseline cooking efficiency of 22.5%, and infrared cooking efficiency of 35%.

³⁰¹ Duty cycle from Food Service Technology Center Broiler Technical Assessment, Table 4.3.

³⁰² Typical operating hours based on oven operating schedule of 8 hours per day, 6 days per week, 52 weeks per year, provided in Food Service Technology Center Oven Technical Assessment, Table 7.2.

³⁰³ Food Service Technology Center Broiler Technical Assessment, Table 4.3.

4.2.15 Infrared Upright Broiler

DESCRIPTION

This measure applies to natural gas fired high efficiency upright broilers utilizing infrared burners and installed in a commercial kitchen.

This measure was developed to be applicable to the following program types: TOS. If applied to other program types, the measure savings should be verified.

DEFINITION OF EFFICIENT EQUIPMENT

To qualify for this measure the installed equipment must be a new natural gas upright broiler with infrared burners.

DEFINITION OF BASELINE EQUIPMENT

The baseline equipment is an existing natural gas upright broiler without infrared burners.

DEEMED LIFETIME OF EFFICIENT EQUIPMENT

The expected measure life is assumed to be 12 years.³⁰⁴

DEEMED MEASURE COST

The incremental capital cost for this measure is \$4,400.³⁰⁵

LOADSHAPE

N/A

COINCIDENCE FACTOR

N/A

Algorithm

CALCULATION OF SAVINGS

ELECTRIC ENERGY SAVINGS

N/A

SUMMER COINCIDENT PEAK DEMAND SAVINGS

N/A

FOSSIL FUEL SAVINGS

Custom calculation below based on Food Service Technology Center calculator, otherwise use deemed value of 943 therms based on default values.

$$\Delta Therms = \frac{(InputRate_{Base} - InputRate_{EE}) * Duty * Days * HoursDay}{100,000}$$

Where:

InputRate_{Base} = Rated energy input rate of baseline upright broiler (Btu/hr)
 = 144,000 Btu/hr³⁰⁶

³⁰⁴ Lifecycle determined from Food Service Technology Center Gas Broiler Life-Cycle Cost Calculator and from FSTC Broiler Technology Assessment.

³⁰⁵See 'Arkansas Deemed TRM Table for GasFoodService.xls' from v3.0 Arkansas Technical Reference Manual.

³⁰⁶ Baseline energy input rate calculated based on efficient energy input rate of 90,000 Btu/hr, baseline cooking efficiency of 25%, and infrared cooking efficiency of 40%.

InputRate _{EE}	= Rated energy input rate of infrared upright broiler (Btu/hr) = Custom; or if unknown, use 90,000 Btu/hr ³⁰⁷
Duty	= Duty cycle of upright broiler (%) = Custom; or if unknown, use 70% ³⁰⁸
Days	= Days per year upright broiler is operating = Custom of if unknown assume 312 (6 days a week, 52 weeks per year) ³⁰⁹
HoursDay	= Typical daily operating hours of upright broiler = Custom; or if unknown, assume 8 hours ³¹⁰
100,000	= Btu to therms conversion factor

WATER IMPACT DESCRIPTIONS AND CALCULATION

N/A

DEEMED O&M COST ADJUSTMENT CALCULATION

N/A

MEASURE CODE: CI-FSE-IRUB-V03-240101

REVIEW DEADLINE: 1/1/2028

³⁰⁷ Median rated energy input for upright broilers from FSTC Broiler Technology Assessment, Section 4.0: Broiler, Table 4.3.

³⁰⁸ Duty cycle from Food Service Technology Center Broiler Technical Assessment, Table 4.3.

³⁰⁹ Typical operating hours based on oven operating schedule of 8 hours per day, 6 days per week, 52 weeks per year, provided in Food Service Technology Center Oven Technical Assessment, Table 7.2.

³¹⁰ Food Service Technology Center Broiler Technical Assessment, Table 4.3.

4.2.16 Kitchen Demand Ventilation Controls

DESCRIPTION

Installation of commercial kitchen demand ventilation controls that vary the ventilation based on cooking load and/or time of day.

IECC 2018 and 2021 specifies that Kitchen Demand Control Ventilation is a mandatory compliance pathway for systems over 5,000 CFM of exhaust airflow. As stated, each kitchen exhaust hood shall comply with one of the following:

- Not < 50% of all replacement air shall be transfer air that would otherwise be exhausted.
- Demand ventilation systems on not < 75% of the exhaust air that are configured to provide not less than 50% reduction in exhaust and replacement air system airflow rates including controls necessary to modulate airflow in response to appliance operation and maintain full capture and containment of smoke, effluent, and combustion products during cooking and idle.
- Listed energy recovery devices with a sensible heat recovery effectiveness not < 40% on not < 50% of the total exhaust airflow.

If one of these alternate compliance options is met, kitchen demand ventilation controls would not be required by code; however, in these situations the demand ventilation controls would be considered redundant and the energy savings would likely be reduced. As a result, this measure is only applicable to new kitchens/systems under 5,000 CFM of exhaust airflow.

This measure was developed to be applicable to the following program types: NC, RF, TOS. If applied to other program types, the measure savings should be verified.

DEFINITION OF EFFICIENT EQUIPMENT

To qualify for this measure the installed equipment must be a control system that varies the exhaust rate of kitchen ventilation (exhaust and/or makeup air fans) based on the energy and effluent output from the cooking appliances (i.e., the more heat and smoke/vapors generated, the more ventilation needed). There are three main demand control ventilation systems available that can achieve this type of modulation:

- Temperature sensors only. These systems ramp ventilation up and down based solely on the temperature from the cooking activity as measured in the ductwork or capture tank of the hood.
- Temperature and optical sensors. These systems offer the same functionality as systems with only temperature sensors plus the ability to change the ventilation rate based on the presence of smoke or steam.
- Temperature and infrared cooking sensors. These systems offer the same functionality as systems with only temperature sensors plus the ability to measure ventilation up and down based on when cooking starts.

DEFINITION OF BASELINE EQUIPMENT

The baseline equipment is kitchen ventilation that has constant speed ventilation motor.

DEEMED LIFETIME OF EFFICIENT EQUIPMENT

The expected measure life is assumed to be 20 years.³¹¹

DEEMED MEASURE COST

The incremental capital cost for this measure is:³¹²

³¹¹ "Commercial Kitchen Ventilation: An Energy Efficiency Program Administrator's Guide to Demand Control Ventilation", CEE, October 2010 (pg. 9). The 20-year measure life estimate is based on interviews with manufacturer and industry experts.

³¹² The incremental costs were derived from Southern California Edison (SCE) program data on 72 demand control kitchen ventilation project installations between 2013 and 2017 (see;

Measure Category	Incremental Cost \$/HP of Fan
DVC Control Retrofit	\$1,992
DVC Control New	\$1,180

LOADSHAPE

Loadshape C23 - Commercial Ventilation

COINCIDENCE FACTOR

The measure has deemed peak kW savings therefore a coincidence factor does not apply.

Algorithm

CALCULATION OF SAVINGS

Annual energy use was based on monitoring results from five different types of sites, as summarized in PG&E Food Service Equipment work paper.

ELECTRIC ENERGY SAVINGS

kWh savings are assumed to be 4,423 kWh per horsepower of the fan.³¹³

SUMMER COINCIDENT PEAK DEMAND SAVINGS

kW savings are assumed to be 0.551 kW per horsepower of the fan.³¹⁴

FOSSIL FUEL SAVINGS

$$\Delta\text{Therms} = \text{CFM} * \text{HP} * \text{Annual Heating Load} / (\text{Eff}(\text{heat}) * 100,000)$$

Where:

CFM = the average airflow reduction with ventilation controls per hood
= 430 cfm/HP³¹⁵

HP = actual if known, otherwise assume 9.65 HP³¹⁶

Annual Heating Load = Annual heating energy required to heat fan exhaust make-up air, Btu/cfm dependent on location:³¹⁷

Zone	Annual Heating Load, Btu/cfm
1 (Rockford)	46,627

“SCE13CC008_ Exhaust_Hood_DCKV_Exhaust_CFM_and_Cost_Field_Data.xlsx”). For reference, the baseline measure costs were factored out accordingly, being obtained from costs for five kitchen exhaust fans from RSMMeans online in 2017. For more detail on the source of these cost estimates, please see the California eTRM – Exhaust Hood Demand Controlled Ventilation, Commercial measure (SWFS012-01), March 4, 2020.

³¹³ Based on data provided in Southern California Edison Workpaper “Commercial Kitchen Exhaust Hoods Demand Controlled Ventilation, June 11, 2014..

³¹⁴ Based on data provided in Southern California Edison Workpaper “Commercial Kitchen Exhaust Hoods Demand Controlled Ventilation, June 11, 2014. Normalized demand reduction over 11 sites was 0.612 kW/HP. Applying a 0.9 CF results in a coincident demand reduction of 0.551 kW/HP.

³¹⁵ Based on data provided in PGE Workpaper, Commercial Kitchen Demand Ventilation Controls, PGECOFST116, June 1, 2009. See ‘Kitchen DCV.xls’ for details.

³¹⁶ Average of 72 study sites in Southern California Edison Workpaper “Commercial Kitchen Exhaust Hoods Demand Controlled Ventilation, June 11, 2014.

³¹⁷ Hours are from Commercial Kitchen Demand Ventilation Controls (Average 17.8 hours a day 4.45 am to 10.30 pm). Savings for all locations were calculated using NCEI 15-yr HDD data, and properties of air at atmospheric conditions and room temperature. See reference file “Kitchen DCV rev2.0.xlsx”

Zone	Annual Heating Load, Btu/cfm
2-(Chicago)	39,688
3 (Springfield)	33,597
4-(Belleville)	20,991
5-(Marion)	22,128

Eff(heat) = Heating Efficiency
 = actual if known, otherwise assume 80%³¹⁸
 100,000 = conversion from Btu to Therm

For example, a kitchen hood in Rockford, IL with a 9.65 HP ventilation motor
 Δ Therms = $430 * 9.65 * 46,627 / (0.80 * 100,000)$
 = 2,418 Therms

WATER IMPACT DESCRIPTIONS AND CALCULATION

N/A

DEEMED O&M COST ADJUSTMENT CALCULATION

N/A

MEASURE CODE: CI-FSE-VENT-V07-250101

REVIEW DEADLINE: 1/1/2028

³¹⁸Work Paper WPRRSGNGRO301 CLEAResult"Boiler Tune-Up" which cites Focus on Energy Evaluation Business Programs: Deemed Savings Manual V1.0, PA Consulting, KEMA, March 22, 2010.

4.2.17 Pasta Cooker

DESCRIPTION

This measure applies to natural gas fired dedicated pasta cookers as determined by the manufacturer and installed in a commercial kitchen.

This measure was developed to be applicable to the following program types: TOS. If applied to other program types, the measure savings should be verified.

DEFINITION OF EFFICIENT EQUIPMENT

To qualify for this measure the installed equipment must be a new natural gas fired pasta cooker.

DEFINITION OF BASELINE EQUIPMENT

The baseline equipment is an existing natural gas fired stove where pasta is cooked in a pan.

DEEMED LIFETIME OF EFFICIENT EQUIPMENT

The expected measure life is assumed to be 12.³¹⁹

DEEMED MEASURE COST

The incremental capital cost for this measure is \$2,400.³²⁰

LOADSHAPE

N/A

COINCIDENCE FACTOR

N/A

Algorithm

CALCULATION OF SAVINGS

ELECTRIC ENERGY SAVINGS

N/A

SUMMER COINCIDENT PEAK DEMAND SAVINGS

N/A

FOSSIL FUEL SAVINGS

The annual natural gas energy savings from this measure is a deemed value equaling 1380 Therms.³²¹

WATER IMPACT DESCRIPTIONS AND CALCULATION

N/A

DEEMED O&M COST ADJUSTMENT CALCULATION

N/A

³¹⁹See 'Arkansas Deemed TRM Table for GasFoodService.xls' from v3.0 Arkansas Technical Reference Manual.

³²⁰Ibid.

³²¹ See 'Arkansas Deemed TRM Table for GasFoodService.xls' from v3.0 Arkansas Technical Reference Manual.

MEASURE CODE: CI-FSE-PCOK-V03-240101

REVIEW DEADLINE: 1/1/2028

4.2.18 Rack Oven - Double Oven

DESCRIPTION

This measure applies to natural gas fired high efficiency rack oven - double oven installed in a commercial kitchen.

This measure was developed to be applicable to the following program types: TOS. If applied to other program types, the measure savings should be verified.

DEFINITION OF EFFICIENT EQUIPMENT

To qualify for this measure the installed equipment must be a new natural gas rack oven - double oven with a baking efficiency $\geq 56\%$.³²²

DEFINITION OF BASELINE EQUIPMENT

The baseline equipment is an existing natural gas rack oven – double oven with a baking efficiency $<51\%$.³²³

DEEMED LIFETIME OF EFFICIENT EQUIPMENT

The expected measure life is assumed to be 12 years.³²⁴

DEEMED MEASURE COST

The incremental capital cost for this measure is \$3,000.³²⁵

LOADSHAPE

N/A

COINCIDENCE FACTOR

N/A

Algorithm

CALCULATION OF SAVINGS

ELECTRIC ENERGY SAVINGS

N/A

SUMMER COINCIDENT PEAK DEMAND SAVINGS

N/A

FOSSIL FUEL SAVINGS

Custom calculation below, otherwise use deemed value of 585 therms based on default values.³²⁶

$$\Delta Therms = \Delta DailyPreheatEnergy + \Delta DailyIdleEnergy + \Delta DailyCookingEnergy) * Days / 100,000$$

$$\Delta DailyPreheatEnergy = DailyPreheats * (PreheatEnergyBase - PreheatEnergyEE)$$

³²² Based on average test data per ASTM F2093 used in California Foodservice Rack Oven Memo 09202019 Attachment supporting the CAeTRM.

³²³ Ibid.

³²⁴ Lifecycle determined from Food Service Technology Center Gas Rack Oven Life-Cycle Cost Calculator and from FSTC Oven Technology Assessment.

³²⁵ See 'Arkansas Deemed TRM Table for GasFoodService.xls' from v3.0 Arkansas Technical Reference Manual.

³²⁶ Assumptions derived from Food Service Technology Center Gas Rack Oven Life-Cycle Cost Calculator, FSTC Oven Technology Assessment, Section 7: Ovens, and from FSTC Gas Double Rack Oven Test Reports.

$$\Delta DailyIdleEnergy = (IdleRateBase * (Hours - \frac{LB}{PCBase} - \frac{DailyPreheats*PreheatTime}{60})) - (IdleRateEE * (Hours - \frac{LB}{PCEE} - \frac{DailyPreheats*PreheatTime}{60}))$$

$$\Delta DailyCookingEnergy = (\frac{LB * EFOOD}{EffBase}) - (\frac{LB * EFOOD}{EffEE})$$

Where³²⁷:

- DailyPreheats = Number of preheats per day
= Custom; or if unknown, 1
- PreheatEnergy_{EE} = Preheat energy of energy efficient rack oven – double oven
= Custom; or if unknown 65,758 Btu
- PreheatEnergy_{Base} = Preheat energy of baseline rack oven – double oven
= Custom; or if unknown 90,009 Btu
- IdleRate_{EE} = Idle rate of energy efficient rack oven – double oven
= Custom; or if unknown, 24,600 Btu/hr
- IdleRate_{Base} = Idle rate of baseline rack oven – double oven
= Custom; or if unknown, 36,909 Btu/hr
- LB = Pounds of food cooked per day
= Custom; or if unknown, 1,200 lb/day
- PC_{EE} = Production capacity of energy efficient rack oven – double oven
= Custom; or if unknown, 279 lbs/hour
- PC_{Base} = Production capacity of baseline rack oven – double oven
= Custom; or if unknown, 272 lbs/hour
- PreheatTime = Length of a single preheat
= Custom; or if unknown, 20 minutes
- 60 = Conversion of minutes to hour
- EFOOD = ASTM energy to food ratio, the energy absorbed by food during cooking
= 235 Btu/lb
- Eff_{EE} = Cooking efficiency of energy efficient rack oven – double oven
= Custom; or if unknown, use 56%
- Eff_{Base} = Cooking efficiency of baseline rack oven – double oven
= Custom; or if unknown, 51%
- Days = 365³²⁸
- Hours = Average daily hours of operation

³²⁷ Unless noted otherwise, assumptions consistent with Southern California Gas Company (SCG). 2019. “Reformulated baseline efficiencies and eligibility requirements for Commercial Rack Oven workpaper SWFS014-01.” Memorandum submitted to Peter Biermayer (Energy Division) and Sue Haselhorst (Ex Ante Review Team). September 18.

³²⁸ Consistent with the ENERGY STAR Commercial Food Service Equipment Calculator, updated March 2024.

100,000 = Custom; or if unknown, use 12 hours³²⁹
= Btu to therms conversion factor

WATER IMPACT DESCRIPTIONS AND CALCULATION

N/A

DEEMED O&M COST ADJUSTMENT CALCULATION

N/A

MEASURE CODE CI-FSE-RKOV-V04-240101

REVIEW DEADLINE: 1/1/2028

³²⁹ Typical operating hours based on oven operating schedule of 12 hours per day provided in FSTC Gas Double Rack Oven Test Reports on various double rack ovens.

4.2.19 ENERGY STAR Electric Convection Oven – Removed in v11, consolidated with 4.2.5
ENERGY STAR Convection Oven

4.2.20 Efficient Dipper Wells

DESCRIPTION

Various commercial food establishments utilize dipper wells that continuously run fresh water over utensils. One example is an ice cream shop that places the ice cream scooper in the dipper well, in order to keep them clean and avoid cross-mixing of flavors. Some restaurants may utilize a dipper well to store potato slicers and butter-ball scoopers. Coffee shops often utilize a dipper well for storage of drink thermometers and mixing spoons. Bars may utilize a dipper well for storage of mixing spoons, strainers, ice tongs, and other utensils. Dipper wells may also be found in grocery stores, school cafeterias, and other institutional kitchens.

Commercial kitchen equipment vendors have developed water-efficient dipper well designs which eliminate the continuous water flow. The efficient design recirculates the water in the well rather than continuously adding fresh water. For bacteriological control some designs utilize a chemical disinfectant (i.e., bleach) and some utilize ozone.

The calculated water savings (in gallons/year) will, in turn, be used to calculate electricity savings (in kWh/year) after applying the appropriate energy factor.

Heated dipper wells are not included in this characterization as the electric penalty associated with the electric resistance heating removes all potential electric savings due to water characterization.

This measure was developed to be applicable to the following program types; EREP and TOS. If applied to other program types, the measure savings should be verified.

DEFINITION OF EFFICIENT EQUIPMENT

The efficient equipment is assumed to be a dipper well that does not continuously run. One type of water-efficient dipper well design recirculates the water in the basin, rather than continuously adding fresh water. The efficient design will employ chemical or ozone sanitation.

Other types of water-efficient dipper well utilize a spatula or shower, where water is only applied to the surface of the utensil when a pressure switch is activated. The dimensions of water-efficient dipper wells will vary, depending on the number of utensils that need to be handled. The flow rate of the spigot is similar between the baseline equipment and the efficient equipment. However, that flow rate only occurs when the well initially fills up or the pressure switch is activated.

DEFINITION OF BASELINE EQUIPMENT

The baseline equipment is assumed to be a dipper well providing continuously running fresh water to the utensils in the basin. As a result, there is a concurrent stream of wastewater that is continuously sent to the sewer. The dipper well typically will run during the hours of operation for the restaurant or bar. Some dipper wells will also be left on during the night when the establishment is closed.

Many dipper wells consist of two concentric tanks. Water flows into the inner tank and overflows through the perforations at the top to the outer tank, which is connected to the sewer drain. Other designs utilize just one tank, with some other means of overflow drainage to the sewer.

DEEMED LIFETIME OF EFFICIENT EQUIPMENT

The expected measure life is assumed to be 10 years.³³⁰

³³⁰ Alignment with existing dipper well program measure lives in California. Dipper Well Replacement Field Evaluation Report, Frontier Energy, November 2017.

https://fishnick.com/publications/fieldstudies/Dipper_Well_Replacement_Field_Evaluation_ICP.pdf

DEEMED MEASURE COST

The cost for this measure is assumed to be \$450 for Early Replacement or \$300 for Time of Sale. The typical material cost for an efficient dipper well system is approximately \$150 to \$350.³³¹ The typical material cost for a baseline dipper well system is approximately \$100 to \$200.³³² Full installation costs, including plumbing materials, labor, and any associated controls, should be used for screening purposes.

LOADSHAPE

Loadshape C01 - Commercial Electric Cooking

COINCIDENCE FACTOR

N/A

Algorithm

CALCULATION OF SAVINGS

Energy savings from the efficient dipper well systems are the result of reduced water consumption. There are indirect electric energy savings from reduced potable water treatment and wastewater treatment energy inputs.

ELECTRIC ENERGY SAVINGS

Secondary kWh Savings for Water Supply and Wastewater Treatment

The following savings should be included in the total savings for this measure, but should not be included in TRC tests to avoid double counting the economic benefit of water savings.

The electric energy savings are based indirectly on the reduced electricity usage used to provide the potable water and treat the wastewater. By applying an “Energy Factor”, the water savings (in gallons/year) can be converted to electricity savings (in kWh/year). This “Energy Factor” considers the electric energy requirements of potable water treatment plants, potable water distribution, wastewater treatment plants, and wastewater distribution.

$$\Delta\text{kWh}_{\text{water}} = \Delta\text{Water (gallons)} / 1,000,000 * E_{\text{water total}}$$

Where:

$$E_{\text{water total}} = \text{IL Total Water Energy Factor (kWh/Million Gallons)} \\ = 5,010^{333}$$

³³¹ Google Shopping search for the term “water efficient dipper well”. Results include the “ConserveWell” from KaTom Restaurant Supply for \$300.

³³² Google Shopping search for the term “dipper well system”. Results show various baseline models that range from \$100 to \$200.

³³³ This factor include 2571 kWh/MG for water supply based on Illinois energy intensity data from a 2012 ISAWWA study and 2439 kWh/MG for wastewater treatment based on national energy intensity use estimates. For more information please review Elevate Energy’s ‘IL TRM: Energy per Gallon Factor, May 2018 paper’.

For example,

$$\text{BAWU} = (\text{DWOH} * \text{AO}) / (\text{TFOG} * 1 \text{ hour}/60 \text{ min})$$

$$= [16 \text{ hours}/\text{day}] * [365 \text{ day}/\text{year}]$$

$$[0.5 \text{ gal}/\text{min}] * [1 \text{ hour}/60 \text{ min}]$$

$$= 175,200 \text{ gal}/\text{year}$$

$$\text{ECAWU} = 3,650 \text{ gal}/\text{year}$$

$$\Delta\text{Water} = \text{BAWU} - \text{ECAWU}$$

$$= 175,200 \text{ gal}/\text{year} - 3,650 \text{ gal}/\text{year}$$

$$= 171,550 \text{ gal}/\text{year}$$

$$\Delta\text{kWhwater} = \Delta\text{Water} / 1,000,000 * \text{Ewater total}$$

$$= (171,500 \text{ gal. of water}/\text{year}) / 1,000,000 * 5,010 \text{ kWh}/\text{million gallons}$$

$$= 859 \text{ kWh}/\text{year}$$

SUMMER COINCIDENT PEAK DEMAND SAVINGS

N/A

FOSSIL FUEL SAVINGS

N/A

WATER IMPACT DESCRIPTIONS AND CALCULATION

The methodology for quantifying the water savings involves a direct comparison of the baseline equipment to the efficient equipment. The baseline flow rate will typically be between 0.2 gpm to 1.0 gpm.³³⁴ The actual flow rate of the baseline equipment should be directly measured. This can be accomplished by recording the time required to fill a 1-gallon container (minutes per gallon); taking the inverse of that value will give the water flow rate (gallons per minute). The number of hours per day that the spigot remains flowing should be determined. This is typically coincident with the operating hours of the establishment, but the spigot could remain flowing during off hours too.

The equation for calculating the baseline annual water usage is as follows:

$$\text{BAWU} = [\text{DWOH} * \text{AO}] / [\text{TFOG} * (1 \text{ hour}/60 \text{ min})]$$

Where:

BAWU = Baseline Annual Water Usage (gal/year)

DWOH = Dipper Well Operating Hours (hours/day)

AO = Annual Operations (days/year)

TFOG = Time to Fill One Gallon (min/gal)

Estimating the efficient-case water consumption will require an understanding of how the dipper well will be used. If the efficient-case equipment utilizes a constantly circulating pool of chemically treated water, then the only water consumption is that required to fill the basin. Depending on the number of times that the basin is filled and emptied in a day, the annual water consumption for the efficient case can be calculated as follows:

$$\text{ECAWU} = \text{BV} * \text{BFPD} * \text{AO}$$

Where:

³³⁴ Michael Slater and Amin Delagah, “Dipper Well Replacement Field Evaluation Report”, Frontier Energy Report #50115-R0, November 2017. Prepared for the Metropolitan Water District of Southern California. <http://www.bewaterwise.com/pdfs/ICP/2015ICP-DipperWellFrontierEnergy.pdf>

ECAWU	= Efficient Case Annual Water Usage (gal/year)
BV	= Basin Volume (gal)
BFPD	= Basin Fills Per Day (days-1)
AO	= Annual Operations (days/year)

If the efficient-case equipment utilizes a ‘shower’ that only dispenses water when the pressure switch is activated, the amount of water consumption is dependent on the number of times the ‘shower’ is actuated and the length of each ‘shower’. The Spigot Flow Rate should be similar to that of the baseline equipment (0.2 gal/min to 1.0 gal/min). However, that flow rate is only in effect for the duration that the pressure switch is pressed. This is referred to as the Time of Actuation, and it can generally be estimated as a few seconds per push. Furthermore, the number of times the shower is actuated in a day can be estimated by considering the customer sales volume of the establishment.

The annual water consumption for the efficient case can also be calculated as follows:

$$ECAWU = (SFR \times TA \times NAPD) / (60 \text{ sec/min} \times AO)$$

Where:

ECAWU	= Efficient Case Annual Water Usage (gal/year)
SFR	= Spigot Flow Rate (gal/min)
TA	= Time of Actuation (sec/push)
NAPD	= Number of Actuations per Day (push/day)
AO	= Annual Operations (days/year)

For the purposes of this measure, the Efficient Case daily water usage of 10 gal/day will be used³³⁵. At 365 days/year of usage, the ECAWU will be 3,650 gal/year.

Finally, the annual water savings per year can be calculated as follows:

$$\Delta\text{Water} = \text{BAWU} - \text{ECAWU}$$

Where:

ΔWater	= Total Water Savings (gal/year)
BAWU	= Baseline Annual Water Usage (gal/year)
ECAWU	= Efficient Case Annual Water Usage (gal/year)

DEEMED O&M COST ADJUSTMENT CALCULATION

N/A

MEASURE CODE CI-FSE-EDIP-V02-220101

REVIEW DEADLINE: 1/1/2028

³³⁵ Michael Slater and Amin Delagah, “Dipper Well Replacement Field Evaluation Report”, Frontier Energy Report #50115-R0, November 2017. Prepared for the Metropolitan Water District of Southern California. <http://www.bewaterwise.com/pdfs/ICP/2015ICP-DipperWellFrontierEnergy.pdf>

4.2.21 On-Demand Package Sealers – Provisional Measure

DESCRIPTION

This measure consists of the replacement of standard electric package sealers with new on-demand package sealers in a retail grocery store. The sealers are used for heat-sealing plastic-wrapped packages for retail sale. The typical baseline unit uses a 550-Watt heating element and 50 Watt heat sealing bar at about 280°F or greater and maintains that temperature unless the unit is turned off when not in use.³³⁶ In practice, the units are frequently left on to avoid waiting for the bar to reach operating temperature. Qualifying units use on-demand heat bars or automatic controls that turn off the unit between uses. Different configurations and brands were tested for the baseline at two grocery store chains that included a total of 199 stores.³³⁷ This measure applies to grocery store, convenience store, deli, bakery, butcher, and other commercial with a demonstrated business need.

This measure was developed to be applicable to the following program types: TOS, EREP. If applied to other program types, the measure savings should be verified.

DEFINITION OF EFFICIENT EQUIPMENT

The on-demand package sealer uses controls to turn the equipment off when it is not in use. The functionality of the baseline and on-demand system is similar. The on-demand package sealer operates similarly to the baseline but has a larger heating element. The on-demand package sealer utilizes an automatic control or pressure momentary switch control to power off the heating elements when the equipment is not in use. Controls for the on-demand unit allow the heating element to turn on only when the heating element is pushed down, or the product crosses the automatic controls. By applying pressure to the heating element or activating the automatic controls the on-demand unit engages a switch, which activates the 2,000-Watt heating element until the switch is disengaged, or for a maximum of 3 seconds. The efficient sealers use less energy overall by reducing standby electrical energy use. These machines come in stand-alone or table-top styles.

DEFINITION OF BASELINE EQUIPMENT

The baseline package sealer consists of a heating bar and a larger heating element and is rated at approximately 550 Watts and 0.50 kW, respectively. The heating bar is used to cut the wrapping film as it contacts the heating bar. The larger heating element is used to heat up the wrapping film. When the wrapping film is heated, the film sticks to a package to seal the product. With the conventional package sealer, both heating elements are controlled to keep a constant temperature of 280°F. The units are manually turned on and off. The baseline package sealers come in two styles, a stand-alone unit and a table-top unit.

DEEMED LIFETIME OF EFFICIENT EQUIPMENT

The expected measure life is assumed to be 10 years.³³⁸

DEEMED MEASURE COST

The deemed measure cost for this measure varies based on unit size and type. Please see the table³³⁹ below for typical costs:

³³⁶ Design & Engineering Services Customer Service Organization Southern California Edison, October 2012, Vacuum-Sealing and Packaging Machines For Food Service Applications Field Test Et10sce1450, pg 1.

³³⁷ The October 2012 SCE field test (mentioned above) was a study based datalogger information over six weeks of units in 199 stores.

³³⁸ Based on similar equipment types, as there is not a standard for shrink wrappers listed. The Illinois TRM v9's kitchen equipment measure lives range from 5-20 years. 70% of the kitchen equipment measures have a 12 year measure life, but half of these are gas-only measures. We used Efficient Dipper Wells' measure life of 10 years as both measures save energy by replacing continuously running equipment with equipment that only runs when needed. Both On-Demand Package Sealers and Efficient Dipper Wells also may have higher regular maintenance needs than the other Kitchen equipment - to prevent clogging.

³³⁹ Commercial Vacuum Sealer costs – Manual (Baseline) & Automatic. Please see pdf of <https://www.webrestaurantstore.com/> data sets.

Equipment Category	Tabletop Unit	Floor Unit
Baseline	\$825	\$2,349
Efficient	\$1,215	\$4,304

LOADSHAPE

N/A

COINCIDENCE FACTOR

N/A

Algorithm

CALCULATION OF ENERGY SAVINGS

ELECTRIC ENERGY SAVINGS

$$\Delta kWh = ((Watts_{base} * HOU) / 1,000) - (((Watts_{efficient} * HOU) / 1,000) * (1 - ESF))$$

Where:

Watts_{base} = Wattage of Existing Equipment’s heating element
 = If not known, use 600 W³⁴⁰

Watts_{efficient} = Wattage of Proposed Efficient Equipment sealing element
 = If not known, use 2,000 W³⁴¹

HOU = Use known Hours of Use
 = If hours not known, hours are selected from the fixture hours column of the Reference Table in Section 4.5 for each building type.

ESF = Energy Savings Factor
 = If ESF not known, use 90%³⁴²

For example, a new on-demand package sealer replacing a baseline package sealer with unknown hours at a grocery store saves:

$$\begin{aligned} \Delta kWh &= ((600 * 5,468) / 1,000) - (((2,000 * 5,468) / 1,000) * (1 - 0.9)) \\ &= 2,187.2 \text{ kWh} \end{aligned}$$

SUMMER COINCIDENT PEAK DEMAND SAVINGS

$$\Delta kW = \frac{\Delta kWh}{HOU} * CF$$

³⁴⁰ Design & Engineering Services Customer Service Organization Southern California Edison, October 2012, Vacuum-Sealing And Packaging Machines For Food Service Applications Field Test Et10sce1450 – Note: this was a study based datalogger information over six weeks of units in 199 stores.

³⁴¹ Ibid

³⁴² ESF assumes On-Demand Package Sealer is actively heating 10% of the Hours of Use. The ESF source assumption is that the On-Demand sealers will be in use an average of six minutes of every hour. Currently there is no logged data that captures the total amount of time the efficient machines run, however once we get that data is available from the program, this value will be updated.

Where:

CF = Coincident Factor, use 1.0.

For example, a new on-demand package sealer replacing a baseline package sealer with unknown hours at a grocery store saves:

$$\begin{aligned}\Delta\text{kWh} &= 2,187.2 / 5,468 * 1.0 \\ &= 0.40 \text{ kW}\end{aligned}$$

FOSSIL FUEL SAVINGS

N/A

WATER AND OTHER NON-ENERGY IMPACT DESCRIPTIONS AND CALCULATION

N/A

DEEMED O&M COST ADJUSTMENT CALCULATION

N/A

MEASURE CODE: CI-FSE-ODPS-V01-220101

REVIEW DEADLINE: 1/1/2025

4.2.22 Automatic Conveyor Broiler

DESCRIPTION

This measure applies to natural gas fired energy efficient automatic conveyor broiler installed in a commercial kitchen. Conveyor broilers are one of the most energy intensive appliances in a commercial kitchen and energy efficient automatic conveyor broilers have potential to save energy while providing similar capacities and reducing the heat load in a kitchen³⁴³.

This measure was developed to be applicable to the following program types: TOS. If applied to other program types, the measure savings should be verified.

DEFINITION OF EFFICIENT EQUIPMENT

To be eligible for rebates, the energy efficient natural gas fired automatic conveyor broiler must have a catalyst and an input rate less than 80 kBtu/hr or a dual stage or modulating valve with a capability of throttling the input rate below 80 kBtu/hr³⁴⁴.

Natural gas fired energy efficient automatic conveyor broilers equipped with electric bun grills and/or electric heating/warming elements are eligible for electric energy savings.

DEFINITION OF BASELINE EQUIPMENT

The base case is defined as natural gas fired automatic conveyor broiler capable of maintaining a temperature above 600°F and an idle rate greater than the energy efficient replacement.

DEEMED LIFETIME OF EFFICIENT EQUIPMENT

The expected measure life is assumed to be 12 years³⁴⁵.

DEEMED MEASURE COST

The incremental capital cost varies based on the conveyor width³⁴⁶:

Conveyor Width (in)	IMC
18in	\$2,523
26in	\$3,146
30in	\$3,659

LOADSHAPE

N/A

COINCIDENCE FACTOR

Summer Peak Coincidence Factor for measure is 0.90³⁴⁷.

Algorithm

³⁴³ “California eTRM: Automatic Conveyor Broiler, Commercial”, July 29th ,2021

<https://www.caetrm.com/measure/SWFS017/02/>

³⁴⁴ “California eTRM: Automatic Conveyor Broiler, Commercial”, July 29th ,2021 as well as “New York Standard Approach for Estimating Energy Savings from Energy Efficiency Programs: Conveyor Broiler”, August 30th , 2021, Page 410.

³⁴⁵ “California eTRM: Automatic Conveyor Broiler, Commercial”, July 29th ,2021

<https://www.caetrm.com/measure/SWFS017/02/>

³⁴⁶ Ibid.

³⁴⁷ “California eTRM: Automatic Conveyor Broiler, Commercial”, July 29th ,2021

<https://www.caetrm.com/measure/SWFS017/02/>

CALCULATION OF ENERGY SAVINGS

ELECTRIC ENERGY SAVINGS

Natural gas fired energy efficient automatic conveyor broilers equipped with electric bun grills and/or electric heating/warming elements are eligible for electric energy savings.

$$\Delta kWh = kWh_{base} - kWh_{eff}$$

$$kWh = Electrical_{IDLE}(kW) * Hours_{DAY} * Days$$

Where:

Electrical_{IDLE}(kW) = Electrical Idle Energy Rate. See table below³⁴⁸. If known, use actual.

Conveyor Width (in)	Baseline Idle Energy Rate (kW)	EE Idle Energy Rate (kW)
<20in	1.84	0.20
20in -26in	1.35	0.37
>26in	4.80	1.15

Hours_{DAY} = Daily Operating Hours. See table below. If known, use actual.

Location	Hours _{DAY}
Smaller restaurants; 2 nd broiler in 24-hr restaurant	8 hours ³⁴⁹
24 hour restaurant	23 hours ³⁵⁰

Days = Days per year of operation

= Actual, default =

Location	Days
Smaller restaurants; 2 nd broiler in 24-hr restaurant	312 days ³⁵¹
24 hour restaurant	363 days ³⁵²

For example, using the default assumptions on the installation of an efficient automatic conveyor broiler with a width less than 20 inches in a small restaurant:

$$\begin{aligned}
 kWh_{base} &= 1.84 \text{ kW} * 8 \text{ hours} * 312 \text{ days} \\
 &= 4,592.64 \text{ kWh} \\
 kWh_{eff} &= 0.20 \text{ kW} * 8 \text{ hours} * 312 \text{ days} \\
 &= 499.2 \text{ kWh} \\
 \Delta kWh &= 4592.64 \text{ kWh} - 499.20 \text{ kWh} \\
 &= 4,093.4 \text{ kWh}
 \end{aligned}$$

³⁴⁸ Ibid.

³⁴⁹ Assumptions derived from Food Service Technology Center Gas Broiler Life-Cycle Cost Calculator and from FSTC Broiler Technology Assessment, Section 4: Broilers.

³⁵⁰ "California eTRM: Automatic Conveyor Broiler, Commercial", July 29th ,2021
<https://www.caetrm.com/measure/SWFS017/02/>

³⁵¹Typical annual operating time from FSTC Broiler Technology Assessment, Table 4.3.

³⁵² "California eTRM: Automatic Conveyor Broiler, Commercial", July 29th ,2021
<https://www.caetrm.com/measure/SWFS017/02/>

SUMMER COINCIDENT PEAK DEMAND SAVINGS

$$\Delta kW = \Delta kWh / \text{AnnualHours} * CF$$

Where:

ΔkWh = Annual kWh savings from measure as calculated above.

$$\text{AnnualHours} = \text{Hours}_{\text{SDAY}} * \text{Days}$$

= Actual. If unknown, use values listed above.

CF = Summer Peak Coincidence Factor

= 0.90

FOSSIL FUEL SAVINGS

$$\Delta \text{Therms} = \Delta \text{Idle Energy} + \Delta \text{Preheat Energy} + \Delta \text{Cooking Energy}$$

$$\Delta \text{Idle Energy} = (\text{Idle Energy}_{\text{Base}} - \text{Idle Energy}_{\text{EE}}) / 100,000$$

$$\text{Idle Energy}_{\text{Base}} = (\text{Hours}_{\text{SDAY}} - (\text{LB} / \text{PC}_{\text{Base}}) - (\text{PRE}_{\text{TimeBase}} / 60)) * \text{IDLE}_{\text{Base}}$$

$$\text{Idle Energy}_{\text{EE}} = (\text{Hours}_{\text{SDAY}} - (\text{LB} / \text{PC}_{\text{EE}}) - (\text{PRE}_{\text{TimeEE}} / 60)) * \text{IDLE}_{\text{EE}}$$

Where:

LB = pounds of food cooked per day (lb/day)

PC = Production capacity (lbs/hr)

PRE_{TIME} = Preheat time (min/day)

IDLE = Idle energy rate (Btu/hr)

*If known, use actual values, otherwise see table below:*³⁵³

Conveyor Width (in)	LB (lb/day)		PC (Lbs/hr)		PreTIME (Min)		IDLE (Btu/hr)	
	Base	EE	Base	EE	Base	EE	Base	EE
<20in	75		29	21	10	29	54,500	28,000
20in - 26in	150		48	42	8	16	78,120	47,960
>26in	110		90	86	22	12	104,000	57,000

$$\Delta \text{Preheat Energy} = (\text{PRE}_{\text{ENERGYBase}} - \text{PRE}_{\text{ENERGYEff}}) / 100,000$$

Where:

PRE_{ENERGY} = Preheat energy (Btu)

$$\Delta \text{Cooking Energy} = (\text{Cooking Energy}_{\text{base}} - \text{Cooking Energy}_{\text{Eff}}) / 100,000$$

$$\text{Cooking Energy}_{\text{base}} = (\text{LB} / \text{PC}_{\text{Base}}) * \text{Cooking}_{\text{RateBase}}$$

$$\text{Cooking Energy}_{\text{EE}} = (\text{LB} / \text{PC}_{\text{EE}}) * \text{Cooking}_{\text{RateEE}}$$

Cooking_{RateBase} = Baseline Cooking energy rate (Btu/hr)

Cooking_{RateEE} = Efficient Cooking energy rate (Btu/hr)

³⁵³ “California eTRM: Automatic Conveyor Broiler, Commercial”, July 29th ,2021
<https://www.caetrm.com/measure/SWFS017/02/>

If known, use actual values, otherwise see table below:³⁵⁴

Conveyor Width (in)	PreENERGY (Btu)		CookingRate (Btu/hr)	
	Base	EE	Base	EE
<20in	11,500	13,500	55,000	28,500
20in - 26in	14,130	14,214	78,240	50,938
>26in	42,500	13,500	111,210	67,117

For example, using the default assumptions on the installation of an efficient automatic conveyor broiler with a width less than 20 inches in a small restaurant:

$$\begin{aligned}
 \text{Idle Energy}_{\text{base}} &= (8 - (75 / 29) - (10 / 60)) * 54,500 \\
 &= 285,968.4 \text{ Btu} \\
 \text{Idle Energy}_{\text{EE}} &= (8 - (75 / 21) - (29 / 60)) * 28,000 \\
 &= 110,466.7 \text{ Btu} \\
 \Delta \text{Idle Energy} &= (285,968.4 - 110,466.7) / 100,000 \\
 &= 1.75 \text{ Therms} \\
 \Delta \text{Preheat Energy} &= (11,500 - 13,500) / 100,000 \\
 &= -0.02 \text{ Therms} \\
 \text{Cooking Energy}_{\text{base}} &= (75 / 29) * 55,000 \\
 &= 142,241.4 \text{ Btu} \\
 \text{Cooking Energy}_{\text{EE}} &= (75 / 21) * 28,500 \\
 &= 101,785.7 \text{ Btu} \\
 \Delta \text{Cooking Energy} &= (142,241.4 - 101,785.7) / 100,000 \\
 &= 0.4 \text{ Therms} \\
 \Delta \text{Therms} &= (1.75 + -0.02 + 0.40) \\
 &= 2.1 \text{ Therms}
 \end{aligned}$$

WATER AND OTHER NON-ENERGY IMPACT DESCRIPTIONS AND CALCULATION

N/A

DEEMED O&M COST ADJUSTMENT CALCULATION

N/A

MEASURE CODE: CI-FSE-ACBL-V03-250101

REVIEW DEADLINE: 1/1/2026

³⁵⁴ “California eTRM: Automatic Conveyor Broiler, Commercial”, July 29th ,2021
<https://www.caetrm.com/measure/SWFS017/02/>

4.2.23 Electric Deck Oven

DESCRIPTION

This measure applies to new electric deck ovens installed in a commercial kitchen which have minimum heavy load cooking efficiency and maximum idle rate standards based on lab testing following ASTM F1965-99 (2010).³⁵⁵

This measure was developed to be applicable to the following program types: TOS. If applied to other program types, the measure savings should be verified.

DEFINITION OF EFFICIENT EQUIPMENT

The measure case is described as a new electric deck oven which has a tested minimum heavy load cooking efficiency of 60%, and has an idle energy rate of no greater than 1.3 kW.²

Deck Oven Measure Case:

	Minimum Cooking Efficiency	Maximum Idle Energy Rate
Electric Deck Oven	60%	1.3 kW

DEFINITION OF BASELINE EQUIPMENT

The base case electric deck oven is described as an electric deck oven with a tested average cooking efficiency which does not meet the measure case criteria.

DEEMED LIFETIME OF EFFICIENT EQUIPMENT

The expected effective useful life of the measure electric deck oven is estimated to be 12 years.^{356 357}

DEEMED MEASURE COST

The incremental capital cost for this measure is \$1022 normalized per deck after considering common discounts.³⁵⁸

LOADSHAPE

Loadshape C01 - Commercial Electric Cooking

COINCIDENCE FACTOR

The summer peak coincidence factor for this measure is assumed to be 0.900³⁵⁹

Algorithm

³⁵⁵ American Society for Testing and Materials (ASTM). 2010. *ASTM F1965-99, Standard Test Method for the Performance of Deck Ovens*. West Conshohocken (PA): ASTM International.

³⁵⁶ Robert Mowris & Associates. 2005. *Ninth Year Retention Study of the 1995 Southern California Gas Company Commercial New Construction Program*. Prepared for Southern California Gas Company. Study ID Number 718A.

³⁵⁷ California Public Utilities Commission (CPUC), Energy Division. 2003. *Energy Efficiency Policy Manual v 2.0*.

³⁵⁸ Energy Solutions. 2017. "2016 IMC Analysis - For Cal TF (Energy Solutions).xls"

³⁵⁹ Itron, Inc. 2005. *2004-2005 Database for Energy Efficiency Resources (DEER) Update Study - Final Report*. Prepared for Southern California Edison.

CALCULATION OF ENERGY SAVINGS

ELECTRIC ENERGY SAVINGS³⁶⁰

$$\begin{aligned} \Delta\text{Annual_kWh} &= (\Delta\text{DailyIdleEnergy} + \Delta\text{DailyPreheatEnergy} + \Delta\text{DailyCookingEnergy}) * \text{Days} \\ \Delta\text{DailyIdleEnergy} &= (\text{IdleRate}_{\text{base}} - \text{IdleRate}_{\text{measure}}) * (\text{Hours} - \text{Food} / \text{PC} - \text{Preheats} * \text{PreheatTime} / 60) \\ \Delta\text{DailyPreheatEnergy} &= \text{Preheats} * (\text{PreheatEnergy}_{\text{base}} - \text{PreheatEnergy}_{\text{measure}}) \\ \Delta\text{DailyCookingEnergy} &= (\text{Food} * 0.0732 / \text{CookingEff}_{\text{base}}) - (\text{Food} * 0.0732 / \text{CookingEff}_{\text{measure}}) \end{aligned}$$

Where:^{361 362}

- Days = Annual days of operation
= Actual, or if unknown, use 365 days per year
- Hours = Average daily hours of operation
= Actual, or if unknown, use 12 hours
- IdleRate_{base} = Idle energy rate of baseline electric deck oven
= 1.90 kW
- IdleRate_{measure} = Idle energy rate of measure electric deck oven
= Actual, or if unknown, use 1.30 kW
- Food = Average pounds of food cooked per day
= Actual, or if unknown, use 200 lb/day
- PC = Production Capacity of the electric deck oven
= 60 lb/h
- Preheats = Average number of times the unit is preheated in any given day
= Actual, or if unknown, use 1
- PreheatTime = Estimated time that the unit spends in the preheat mode
= 30 min
- 60 = Minutes to hours conversion factor
- PreheatEnergy_{base} = Energy use of the baseline electric deck oven during a preheat
= Actual, or if unknown, use 6.50 kWh
- PreheatEnergy_{measure} = Energy use of the measure electric deck oven during a preheat
= Actual, or if unknown, use 3.00 kWh
- 0.0732 = ASTM energy to food ratio; the energy absorbed by the food during cooking in kWh/lb
- CookingEff_{base} = Heavy load cooking energy efficiency of the baseline electric deck oven

³⁶⁰ American Society for Testing and Materials (ASTM). 2010. *ASTM F1965-99, Standard Test Method for the Performance of Deck Ovens*. West Conshohocken (PA): ASTM International.

³⁶¹ Food Service Technology Center (FSTC). (n.d.) Proprietary database

³⁶² Southern California Edison (SCE). 2018. "SCE17CC012.1 A2 - Cost & Savings Calculations.xlsm."

= Actual, or if unknown, use 40%

CookingEff_{measure} = Heavy load cooking energy efficiency of the measure electric deck oven

= Actual, or if unknown, use 60%

For example, for a measure case electric deck oven compared to the baseline electric deck oven using the default values from above would save:

$$\Delta\text{Annual_kWh} = (\Delta\text{DailyIdleEnergy} + \Delta\text{DailyPreheatEnergy} + \Delta\text{DailyCookingEnergy}) * \text{Days}$$

Where:

$$\begin{aligned} \Delta\text{DailyIdleEnergy} &= (1.9 - 1.3) * (12 - 200 / 60 - 1 * 30 / 60) \\ &= 4.9 \text{ kWh} \end{aligned}$$

$$\begin{aligned} \Delta\text{DailyPreheatEnergy} &= 1 * (6.5 - 3.0) \\ &= 3.5 \text{ kWh} \end{aligned}$$

$$\begin{aligned} \Delta\text{DailyCookingEnergy} &= (200 * 0.0732 / 0.40) - (200 * 0.0732 / 0.60) \\ &= 12.2 \text{ kWh} \end{aligned}$$

$$\begin{aligned} \Delta\text{Annual_kWh} &= (4.9 + 3.5 + 12.2) * 365 \\ &= 7,519.0 \text{ kWh} \end{aligned}$$

SUMMER COINCIDENT PEAK DEMAND SAVINGS

$$\Delta\text{kW} = \Delta\text{kWh} / (\text{Hours} * \text{Days}) * \text{CF}$$

Where:³⁶³

ΔkWh = Annual kWh savings from measure as calculated above

Hours = Average daily hours of operation
= Actual, or if unknown, use 12 hours

Days = Annual days of operation
= Actual, or if unknown, use 365 days per year

CF = Summer Peak Coincidence Factor for measure
= 0.900

³⁶³ Itron, Inc. 2005. 2004-2005 Database for Energy Efficiency Resources (DEER) Update Study - Final Report. Prepared for Southern California Edison.

For example, for a measure case electric deck oven compared to the baseline electric deck oven using the default values from above would save:

$$\Delta kW = \Delta kWh / (\text{Hours} * \text{Days}) * CF$$

Where:

$$\Delta kWh = \text{Annual kWh savings from measure as calculated from the previous example using default values}$$

$$= 7,519.0 \text{ kWh}$$

$$\Delta kW = 7,519.0 / (12 * 365) * 0.900$$

$$= 1.545 \text{ kW}$$

FOSSIL FUEL SAVINGS

N/A

WATER AND OTHER NON-ENERGY IMPACT DESCRIPTIONS AND CALCULATION

N/A

DEEMED O&M COST ADJUSTMENT CALCULATION

N/A

MEASURE CODE: CI-FSE-EDOV-V01-240101

REVIEW DEADLINE: 1/1/2028

4.2.24 Gas and Electric Pressure Fryers

DESCRIPTION

This measure applies to electric or natural gas fired pressure fryers installed in a commercial kitchen which have a minimum cooking efficiency and maximum idle rate standards based on lab testing following ASTM F1964-21 Standard Test Method for Performance of Pressure Fryers.³⁶⁴

This measure was developed to be applicable to the following program types: TOS and NC. If applied to other program types, the measure savings should be verified.

DEFINITION OF EFFICIENT EQUIPMENT

The measure case is a new pressure fryer which meets the minimum cooking efficiency and maximum idle energy rate standards as tested following ASTM F1964-21.³ These standards are comparable to the ENERGY STAR standards for large open deep fat fryers³⁶⁵ and are based on the efficiency levels of the most efficient pressure fryers tested for each fuel type.

Pressure Fryer Measure Case

	Minimum Cooking Efficiency	Maximum Idle Rate
Electric Pressure Fryer	83%	0.7 kW
Gas Pressure Fryer	40%	9,000 Btu/h

DEFINITION OF BASELINE EQUIPMENT

The base case pressure fryer is described as a pressure fryer with a tested average cooking efficiency and idle energy rate which do not meet the measure case criteria.

DEEMED LIFETIME OF EFFICIENT EQUIPMENT

The expected lifetime of the measure equipment is assumed to be 12 years for electric pressure fryers and 11 years for gas fired pressure fryers.^{366 367}

DEEMED MEASURE COST

The incremental capital cost for this measure is \$6,394 for electric pressure fryers and \$4054 for gas pressure fryers.³⁶⁸

LOADSHAPE

Loadshape C01 - Commercial Electric Cooking

COINCIDENCE FACTOR

N/A

Algorithm

³⁶⁴ American Society for Testing and Materials (ASTM). 2021. *ASTM F1964-21, Standard Test Method for Performance of Pressure Fryers*. West Conshohocken (PA): ASTM International.

³⁶⁵ ENERGY STAR Commercial Fryers Program Program Requirements, version 3.0, October 2016

³⁶⁶ California Public Utilities Commission (CPUC), Energy Division. 2020. *Energy Efficiency Policy Manual Version 6*. April. Page 35

³⁶⁷ Guidehouse, Inc. 2020. *EMV Group A, Deliverable 16 EUL Research - Gas Fryers: Final Report*. Prepared for the California Public Utilities Commission (CPUC). June 2.

³⁶⁸ UNPUBLISHFrontier Energy, Inc. "Pressure_Fryer_Workpaper_Calculations_Draft_R2 2023-07-31.xlsx". May 2023.

CALCULATION OF ENERGY SAVINGS

ELECTRIC ENERGY SAVINGS & FOSSIL FUEL SAVINGS

Non-Fuel Switch Measures:

The algorithms below apply to electric fryers only.

$$\Delta\text{Annual_kWh} = (\Delta\text{DailyIdleEnergy} + \Delta\text{DailyActiveEnergy}) * \text{Days} / 1,000$$

$$\Delta\text{DailyIdleEnergy} = (\text{IdleRate}_{\text{base}} - \text{IdleRate}_{\text{measure}}) * \text{TimeIdle}$$

$$\Delta\text{DailyActiveEnergy} = (\text{TimeActive} * \text{InputRate}_{\text{base}}) - [(\text{TimeActive} * \text{InputRate}_{\text{measure}}) * \text{CookTimeSaved}]$$

The algorithms below apply to gas fryers only.

$$\Delta\text{Annual_Therms} = (\Delta\text{DailyIdleEnergy} + \Delta\text{DailyActiveEnergy}) * \text{Days} / 100,000$$

$$\Delta\text{DailyIdleEnergy} = (\text{IdleRate}_{\text{base}} - \text{IdleRate}_{\text{measure}}) * \text{TimeIdle}$$

$$\Delta\text{DailyActiveEnergy} = (\text{TimeActive} * \text{InputRate}_{\text{base}}) - [(\text{TimeActive} * \text{InputRate}_{\text{measure}}) * \text{CookTimeSaved}]$$

Fuel-Switch / Electrification Measures:

Fuel switch / electrification measures must product positive total energy savings (i.e., reduction in Btus at the premises) in order to qualify. The following algorithm can be used to determine eligibility:

$$\begin{aligned} \text{SiteEnergySavings (MMBTUs)} &= [\text{GasConsumptionReplaced}] - [\text{ElectricalConsumptionAdded}] \\ &= [\text{DailyIdleEnergy}_{\text{GasBase}} + \text{DailyActiveEnergy}_{\text{GasBase}}] - \\ &\quad [\text{DailyIdleEnergy}_{\text{ElectricMeasure}} + \text{DailyActiveEnergy}_{\text{ElectricMeasure}}] \end{aligned}$$

If SiteEnergySavings calculated above is positive, the measure is eligible.

The appropriate savings claims are dependent on which utilities are supporting the measure as provided in a table below:

Measure Supported By:	Electric Utility Claims (kWh):	Gas Utility Claims (therms):
Electric utility only	SiteEnergySavings * 1,000,000/3,412	N/A
Electric and gas utility <small>(Note utilities may make alternative agreements to how savings are allocated as long as total MMBtu savings remain the same).</small>	%IncentiveElectric * SiteEnergySavings * 1,000,000/3,412	%IncentiveGas * SiteEnergySavings * 10
Gas utility only	N/A	SiteEnergySavings * 10

Where:³⁶⁹

- Days = Annual days of operation
= Actual, or if unknown, use 326³⁷⁰ days per year
- 1,000 = Wh to kWh conversion factor
- IdleRate_{base} = Idle energy rate of baseline pressure fryer
= Actual, or if unknown, use:

³⁶⁹ UNPUBLISHED Frontier Energy, Inc. "Pressure_Fryer_Workpaper_Calculations_Draft_R2 2023-07-31.xlsx". May 2023.

³⁷⁰ Fisher-Nickel, Inc. *Characterizing the Energy Efficiency Potential of Gas-Fired Commercial Foodservice Equipment*. Prepared for the California Energy Commission (CEC). CEC-500-2014-095. October 2014.

Equipment Type	IdleRate
Electric	1.0 kW
Gas	10,500 Btu/h

IdleRate_{measure} = Idle energy rate of measure pressure fryer

= Actual, or if unknown, use:

Equipment Type	IdleRate
Electric	0.7 kW
Gas	9,000 Btu/h

TimeIdle = Daily operating time that the electric pressure fryer is in idle state

= Actual, or if unknown, use 9.50 hours

TimeActive = Daily operating time the electric pressure fryer is in an active state (preheat or cook)

= Actual, or if unknown, use 2.64 hours

InputRate_{base} = Preheat energy rate of the baseline pressure fryer

= Actual, or if unknown, use:

Equipment Type	Input Rate
Electric	16 kW
Gas	75,000 Btu/hr

InputRate_{measure} = Preheat energy rate of the measure pressure fryer

= Actual, or if unknown, use:

Equipment Type	Input Rate
Electric	17 kW
Gas	60,000 Btu/hr

CookTimeSaved = Percentage of time saved cooking by the measure electric pressure fryer

= Can be calculated using actual values using the following algorithm:

$$\text{CookTime}_{\text{measure}} / \text{CookTime}_{\text{baseline}}$$

or

if unknown, use 0.88 for an electric pressure fryer or 0.83 for a gas pressure fryer

For fuel-switch / electrification measure use 0.88

Where:

CookTime_{measure} = The amount of time to cook one load of the food product (min)

= Actual, or if unknown, use:

Equipment Type	CookTime (minutes)
Electric	13.5
Gas	12.7

$CookTime_{baseline}$ = The amount of time to cook on load of the food product (min)
 = Actual, or if unknown, use:

Equipment Type	CookTime (minutes)
Electric	15.2
Gas	15.3

100,000 = Btu to therms conversion factor

For example, for a measure case electric pressure fryer replacing a baseline natural gas pressure fryer using the default values from the measure case in Electric Energy Savings above and the base case in Natural Gas Savings below would save:

$$\begin{aligned}
 \text{SiteEnergySavings (MMBTUs)} &= [\text{GasConsumptionReplaced}] - [\text{ElectricalConsumptionAdded}] \\
 &= [(\text{DailyIdleEnergy}_{\text{GasBase}} + \text{DailyActiveEnergy}_{\text{GasBase}}) * \text{Days} / 1,000,000] - [(\text{DailyIdleEnergy}_{\text{ElectricMeasure}} + \text{DailyActiveEnergy}_{\text{ElectricMeasure}}) * \text{Days} * 3,412 / 1,000,000]
 \end{aligned}$$

$$\begin{aligned}
 \text{DailyIdleEnergy}_{\text{GasBase}} &= \text{IdleRate}_{\text{GasBase}} * \text{TimeIdle} \\
 &= 10,500 * 9.50 \\
 &= 99,750 \text{ btu}
 \end{aligned}$$

$$\begin{aligned}
 \text{DailyActiveEnergy}_{\text{GasBase}} &= \text{TimeActive} * \text{InputRate}_{\text{GasBase}} \\
 &= 2.64 * 75,000 \\
 &= 198,000 \text{ btu}
 \end{aligned}$$

$$\begin{aligned}
 \text{DailyIdleEnergy}_{\text{ElectricMeasure}} &= \text{IdleRate}_{\text{ElectricMeasure}} * \text{TimeIdle} \\
 &= 0.700 * 9.50 \\
 &= 6.65 \text{ kWh}
 \end{aligned}$$

$$\begin{aligned}
 \text{DailyActiveEnergy}_{\text{ElectricMeasure}} &= \text{TimeActive} * \text{InputRate}_{\text{ElectricMeasure}} * \text{CookTimeSaved} \\
 &= 2.64 * 17 * 0.88 \\
 &= 39.49 \text{ kWh}
 \end{aligned}$$

$$\begin{aligned}
 \text{SiteEnergySavings (MMBTUs)} &= [(99,750 + 198,000) * 326 / 1,000,000] - [(6.65 + 39.49) * 326 * 3,412 / 1,000,000] \\
 &= 45.9 \text{ MMBTU}
 \end{aligned}$$

$$\begin{aligned}
 \text{If supported by an electric utility} &= \text{SiteEnergySavings} * 1,000,000 / 3,412 \\
 &= 45.9 * 1,000,000 / 3,412 \\
 &= 13,440 \text{ kWh}
 \end{aligned}$$

For example, for a measure case electric pressures compared to the baseline gas pressure fryer using the default values from above would save:

$$\Delta\text{Annual_Therms} = (\Delta\text{DailyIdleEnergy} + \Delta\text{DailyActiveEnergy}) * \text{Days} / 100,000$$

Where:

$$\begin{aligned} \Delta\text{DailyIdleEnergy} &= (10,500 - 9,000) * 9.50 \\ &= 14,250 \text{ Btu} \end{aligned}$$

$$\begin{aligned} \Delta\text{DailyActiveEnergy} &= (2.64 * 75,000) - ((2.64 * 60,000) * 0.83) \\ &= 66,528 \text{ Btu} \end{aligned}$$

$$\begin{aligned} \Delta\text{Annual_Therms} &= (14,250 + 66,528) * 326 / 100,000 \\ &= 263 \text{ Therms} \end{aligned}$$

For example, for a measure case electric pressure fryer compared to the baseline electric pressure fryer using the default values from above would save:

$$\Delta\text{Annual_kWh} = (\Delta\text{DailyIdleEnergy} + \Delta\text{DailyActiveEnergy}) * \text{Days}$$

Where:

$$\begin{aligned} \Delta\text{DailyIdleEnergy} &= (1.0 - 0.7) * 9.50 \\ &= 2.850 \text{ kWh} \end{aligned}$$

$$\begin{aligned} \Delta\text{DailyActiveEnergy} &= (2.64 * 16) - ((2.64 * 17) * 0.88) \\ &= 2.746 \text{ kWh} \end{aligned}$$

$$\begin{aligned} \Delta\text{Annual_kWh} &= (2.850 + 2.746) * 326 \\ &= 1,824 \text{ kWh} \end{aligned}$$

SUMMER COINCIDENT PEAK DEMAND SAVINGS

N/A

WATER AND OTHER NON-ENERGY IMPACT DESCRIPTIONS AND CALCULATION

N/A

DEEMED O&M COST ADJUSTMENT CALCULATION

N/A

COST EFFECTIVENESS SCREENING AND LOAD REDUCTION FORECASTING WHEN FUEL SWITCHING

This measure can involve fuel switching from fossil fuel to electric.

For the purposes of forecasting load reductions due to fuel switch projects per Section 16-111.5B, changes in site energy use at the customer’s meter (using ΔkWh algorithm below), customer switching estimates, NTG, and any other adjustment factors deemed appropriate, should be used.

The inputs to cost effectiveness screening should reflect the actual impacts on the electric and fuel consumption at the customer meter and, for fuel switching measures, should therefore reflect the decrease in one fuel and increase in another, as opposed to the single savings value calculated in the “Electric and Fossil Fuel Energy Savings” section above. Therefore in addition to the calculation of savings claimed, the following values should be used to assess the cost effectiveness of the measure.

$$\begin{aligned}\Delta\text{Therms} &= [\text{Gas Cooking Consumption Replaced}] \\ &= [((\text{IdleRate}_{\text{base}} * \text{TimeIdle}) + (\text{TimeActive} * \text{InputRate}_{\text{base}} * \text{CookTimeSaved})) * \text{Days} / 100,000] \\ \Delta\text{kWh} &= [\text{Electric Cooking Consumption Added}] \\ &= - [((\text{IdleRate}_{\text{measure}} * \text{TimeIdle}) + (\text{TimeActive} * \text{InputRate}_{\text{measure}} * \text{CookTimeSaved})) * \text{Days} / 1,000]\end{aligned}$$

MEASURE CODE: CI-FSE-GEPF-V01-240101

REVIEW DEADLINE: 1/1/2028

4.2.25 Efficient Cooktops

DESCRIPTION

This measure applies to new induction or natural gas cooktops installed in a commercial kitchen which have minimum heavy load cooking efficiency and maximum idle rate standards as defined below, based on lab testing following ASTM F1521-22 Standard Test Methods for Performance of Range Tops.³⁷¹

This measure was developed to be applicable to the following program types: TOS and NC. If applied to other program types, the measure savings should be verified.

DEFINITION OF EFFICIENT EQUIPMENT

The measure case is described as a new cooktop which has a tested minimum cooking efficiency defined below, as determined by lab testing following ASTM F1521. Where applicable, values align with ENERGY STAR program criteria.³⁷²

Induction Cooktop Measure Case:

	Minimum Cooking Efficiency
Induction Cooktop	80%
Gas Cooktop	43%

DEFINITION OF BASELINE EQUIPMENT

The base case cooktop is described as a new natural gas or electric induction cooktop with a tested average cooking efficiency which does not meet the measure case criteria. This measure has not been designed to support electric resistance-based burner designs.

DEEMED LIFETIME OF EFFICIENT EQUIPMENT

The expected effective useful life of the measure cooktop is estimated to be 12 years.^{373 374}

DEEMED MEASURE COST

The incremental capital cost for this measure is defined below, normalized per burner.³⁷⁵

Fuel Source	Incremental Measure Cost
Electric	\$560
Gas	\$127
Fuel-Switch	\$950

LOADSHAPE

Loadshape C01 - Commercial Electric Cooking

³⁷¹ American Society for Testing and Materials (ASTM). 2018. *ASTM F1521-12, Standard Test Method for Performance of Range Tops*. West Conshohocken (PA): ASTM International.

³⁷² ENERGY STAR Commercial Electric Cooktops, version 1.0, drafted January 12, 2023

³⁷³ Itron, Inc. 2005. *2004-2005 Database for Energy Efficiency Resources (DEER) Update Study - Final Report*. Prepared for Southern California Edison.

³⁷⁴ California Public Utilities Commission (CPUC), Energy Division. 2003. *Energy Efficiency Policy Manual v 2.0*.

³⁷⁵ Frontier Energy, Inc. 2023. "Cooktop_Supporting_Data_R2 2023-07-30.xlsx".

COINCIDENCE FACTOR

The summer peak coincidence factor for this measure is assumed to be 0.900⁴

Algorithm

CALCULATION OF ENERGY SAVINGS

ELECTRIC ENERGY SAVINGS AND FOSSIL FUEL SAVINGS³⁷⁶

Non Fuel-Switch Measures:

The algorithms below apply to electric cooktops only.

$$\begin{aligned} \Delta\text{Annual_kWh} &= (\Delta\text{DailyCookingEnergy}) * \text{Days} \\ \Delta\text{DailyCookingEnergy} &= (\text{Food} * (130 / 3,412) / \text{CookingEff}_{\text{base}}) - (\text{Food} * (130 / 3,412) / \text{CookingEff}_{\text{measure}}) \end{aligned}$$

The algorithms below apply to gas cooktops only.

$$\begin{aligned} \Delta\text{Annual_Therms} &= (\Delta\text{DailyCookingEnergy} + \Delta\text{DailyPilotEnergy}) * \text{Days} / 100,000 \\ \Delta\text{DailyCookingEnergy} &= (\text{Food} * 130 / \text{CookingEff}_{\text{base}}) - (\text{Food} * 130 / \text{CookingEff}_{\text{measure}}) \\ \Delta\text{DailyPilotEnergy} &= (\text{PilotRate}_{\text{base}} * (24 - \text{Food} / \text{ProdCap}_{\text{base}})) - (\text{PilotRate}_{\text{measure}} * (24 - \text{Food} / \text{ProdCap}_{\text{measure}})) \end{aligned}$$

Fuel-Switch / Electrification Measures:

Fuel switch / electrification measures must product positive total energy savings (i.e., reduction in Btus at the premises) in order to qualify. The following algorithm can be used to determine eligibility:

$$\begin{aligned} \text{SiteEnergySavings (MMBTUs)} &= [\text{GasConsumptionReplaced}] - [\text{ElectricalConsumptionAdded}] \\ &= [\text{DailyCookingEnergy}_{\text{GasBase}} + \text{DailyPilotEnergy}_{\text{GasBase}}] - [\text{DailyCookingEnergy}_{\text{ElectricMeasure}}] \end{aligned}$$

It should be noted that the Food variable shall be similar from one unit to the other when fuel-switching.

If SiteEnergySavings calculated above is positive, the measure is eligible.

The appropriate savings claims are dependent on which utilities are supporting the measure as provided in a table below:

Measure Supported By:	Electric Utility Claims (kWh):	Gas Utility Claims (therms):
Electric utility only	SiteEnergySavings * 1,000,000/3,412	N/A
Electric and gas utility <small>(Note utilities may make alternative agreements to how savings are allocated as long as total MMBtu savings remain the same).</small>	%IncentiveElectric * SiteEnergySavings * 1,000,000/3,412	%IncentiveGas * SiteEnergySavings * 10
Gas utility only	N/A	SiteEnergySavings * 10

Where:⁷

Days = Annual days of operation

³⁷⁶ Frontier Energy, Inc. 2023. "Cooktop_Supporting_Data_R2 2023-07-30.xlsx"

- = Actual, or if unknown, use 326 days per year
- Food = Average pounds of food cooked per day
- = Actual, or if unknown, use 108 lb/day for an electric cooktop or 143lb/day for a gas cooktop. For fuel switching scenarios, use same Food assumption for both baseline and efficient.
- 130 = ASTM energy to food ratio; the energy absorbed by the food during cooking in Btu/lb
- 3412 = Btu to kWh conversion factor
- CookingEff_{base} = Heavy load cooking energy efficiency of the baseline cooktop
- = Actual, or if unknown, use:

Equipment Type	Cooking Efficiency
Electric	75%
Gas	34%

- CookingEff_{measure} = Heavy load cooking energy efficiency of the measure induction cooktop
- = Actual, or if unknown, use:

Equipment Type	Cooking Efficiency
Electric	84%
Gas	47%

- 100,000 = Btu to therms conversion factor
- PilotRate_{base} = Input energy rate of pilot found on baseline gas cooktop
- = Actual, or if unknown, use 500 Btu/h
- PilotRate_{measure} = Input energy rate of pilot found on measure gas cooktop
- = Actual, or if unknown, use 460 Btu/h
- 24 = Hours in a day
- ProdCap_{base} = Production Capacity of baseline gas cooktop
- = Actual, or if unknown, use 78 lb/h
- ProdCap_{measure} = Production Capacity of measure gas cooktop

= Actual, or if unknown, use 66 lb/h

For example, for a measure case induction cooktop compared to the baseline induction cooktop using the default values from above would save:

$$\Delta\text{Annual_kWh} = \Delta\text{DailyCookingEnergy} * \text{Days}$$

Where:

$$\begin{aligned} \Delta\text{DailyCookingEnergy} &= (108 * (130 / 3412) / 0.75) - (108 * (130 / 3412) / 0.84) \\ &= 0.588 \text{ kWh} \end{aligned}$$

$$\begin{aligned} \Delta\text{Annual_kWh} &= 0.588 * 326 \\ &= 191.628 \text{ kWh} \end{aligned}$$

For example, for a measure case gas cooktop compared to the baseline gas cooktop using the default values from above would save:

$$\Delta\text{Annual_Therms} = (\Delta\text{DailyCookingEnergy} + \Delta\text{DailyPilotEnergy}) * \text{Days} / 100,000$$

Where:

$$\begin{aligned} \Delta\text{DailyCookingEnergy} &= (143 * 130 / 0.34) - (143 * 130 / 0.47) \\ &= 15,123 \text{ Btu} \end{aligned}$$

$$\begin{aligned} \Delta\text{DailyPilotEnergy} &= 500 * (24 - 143 / 78) - 460 * (24 - 143 / 66) \\ &= 1040 \text{ Btu} \end{aligned}$$

$$\begin{aligned} \Delta\text{Annual_Therms} &= (15,123 + 1040) * 326 / 100,000 \\ &= 52.69 \text{ Therms} \end{aligned}$$

For example, for a measure case electric induction cooktop replacing a baseline natural gas cooktop using the default values from the measure case in Electric Energy Savings above and the base case in Natural Gas Savings below would save:

$$\begin{aligned}
 \text{SiteEnergySavings (MMBTUs)} &= [\text{GasConsumptionReplaced}] - [\text{ElectricalConsumptionAdded}] \\
 &= [(\text{DailyCookingEnergy}_{\text{GasBase}} + \text{DailyPilotEnergy}_{\text{GasBase}}) * \text{Days} / 1,000,000 - [\text{DailyCookingEnergy}_{\text{ElectricMeasure}} * \text{Days} * 3,412 / 1,000,000]] \\
 \\
 \text{DailyCookingEnergy}_{\text{GasBase}} &= \text{Food} * 130 / \text{CookingEff}_{\text{GasBase}} \\
 &= 143 * 130 / 0.34 \\
 &= 54,677 \text{ btu} \\
 \\
 \text{DailyPilotEnergy}_{\text{GasBase}} &= \text{PilotRate}_{\text{GasBase}} * (24 - \text{Food} / \text{ProdCap}_{\text{GasBase}}) \\
 &= 500 * (24 - 143 / 78) \\
 &= 11,083 \text{ btu} \\
 \\
 \text{DailyCookingEnergy}_{\text{ElectricMeasure}} &= \text{Food} * 130 / 3,412 / \text{CookingEff}_{\text{ElectricMeasure}} \\
 &= 143 * 130 / 3,412 / 0.84 \\
 &= 6.49 \text{ kWh} \\
 \\
 \text{SiteEnergySavings (MMBTUs)} &= [(54,677 + 11,083) * 326 / 1,000,000] - [6.49 * 326 * 3,412 / 1,000,000] \\
 &= 14.2 \text{ MMBTU} \\
 \\
 \text{If supported by an electric utility} &= \text{SiteEnergySavings} * 1,000,000 / 3,412 \\
 &= 14.2 * 1,000,000 / 3,412 \\
 &= 4,169 \text{ kWh}
 \end{aligned}$$

SUMMER COINCIDENT PEAK DEMAND SAVINGS

$$\Delta \text{kW} = \Delta \text{kWh} / (\text{Hours} * \text{Days}) * \text{CF}$$

Where:³⁷⁷

- ΔkWh = Annual kWh savings from measure as calculated above
- Hours = Average daily hours of operation
= Actual, or if unknown, use 6 hours
- Days = Annual days of operation
= Actual, or if unknown, use 326 days per year
- CF = Summer Peak Coincidence Factor for measure
= 0.900

³⁷⁷ Itron, Inc. 2005. 2004-2005 Database for Energy Efficiency Resources (DEER) Update Study - Final Report. Prepared for Southern California Edison.

For example, for a measure case induction cooktop compared to the baseline induction cooktop using the default values from above would save:

$$\Delta kW = \Delta kWh / (\text{Hours} * \text{Days}) * CF$$

Where:

$$\Delta kWh = \text{Annual kWh savings from measure as calculated from the previous example using default values}$$

$$= 191.628 \text{ kWh}$$

$$\Delta kW = 191.682 / (6 * 326) * 0.900$$

$$= 0.088 \text{ kW}$$

$$\Delta \text{DailyCookingEnergy} = (93 * (130 / 3412.14) / 0.75) - (93 * (130 / 3412.14) / 0.84)$$

$$= 0.506176 \text{ kWh}$$

$$\Delta \text{Annual_kWh} = 0.506176 * 326$$

$$= 119.458 \text{ kWh}$$

WATER AND OTHER NON-ENERGY IMPACT DESCRIPTIONS AND CALCULATION

N/A

DEEMED O&M COST ADJUSTMENT CALCULATION

N/A

COST EFFECTIVENESS SCREENING AND LOAD REDUCTION FORECASTING WHEN FUEL SWITCHING

This measure can involve fuel switching from fossil fuel to electric.

For the purposes of forecasting load reductions due to fuel switch projects per Section 16-111.5B, changes in site energy use at the customer’s meter (using ΔkWh algorithm below), customer switching estimates, NTG, and any other adjustment factors deemed appropriate, should be used.

The inputs to cost effectiveness screening should reflect the actual impacts on the electric and fuel consumption at the customer meter and, for fuel switching measures, should therefore reflect the decrease in one fuel and increase in another, as opposed to the single savings value calculated in the “Electric and Fossil Fuel Energy Savings” section above. Therefore in addition to the calculation of savings claimed, the following values should be used to assess the cost effectiveness of the measure.

$$\begin{aligned} \Delta \text{Therms} &= [\text{Gas Cooking Consumption Replaced}] \\ &= [((\text{PilotRate}_{\text{base}} * (24 - \text{Food} / \text{ProdCap}_{\text{base}})) + (\text{Food} * 130 / \text{CookingEff}_{\text{Gasbase}})) * \text{Days} / 100,000] \end{aligned}$$

$$\begin{aligned} \Delta \text{kWh} &= [\text{Electric Cooking Consumption Added}] \\ &= - [(\text{Food} * (130 / 3,412) / \text{CookingEff}_{\text{Elecmeasure}}) * \text{Days}] \end{aligned}$$

MEASURE CODE: CI-FSE-INDC-V01-240101

REVIEW DEADLINE: 1/1/2028

4.3. Hot Water End Use

4.3.1 Water Heater

DESCRIPTION

This measure is for upgrading from minimum code to a high efficiency water heater. Storage water heaters are used to supply hot water for a variety of commercial building types. Storage capacities vary greatly depending on the application. Large consumers of hot water include (but not limited to) industries, hotels/motels and restaurants.

Tankless water heaters function similar to standard hot water heaters except they do not have a storage tank. When there is a call for hot water, the water is heated instantaneously as it passes through the heating element and then proceeds to the user or appliance calling for hot water. Tankless water heaters achieve savings by eliminating the standby losses that occur in stand-alone or tank-type water heaters and by being more efficient than the baseline storage hot water heater.

Heat pump water heaters use electricity to move heat from one place to another instead of generating heat directly and can allow for additional energy savings. Savings are presented dependent on the heating system installed in the home due to the impact of the heat pump water heater on the heating loads.

This measure was developed to be applicable to the following program types: TOS, NC. If applied to other program types, the measure savings should be verified.

DEFINITION OF EFFICIENT EQUIPMENT

The minimum specifications of the high efficiency equipment should be defined by the programs.

DEFINITION OF BASELINE EQUIPMENT

Time of Sale: The baseline condition is assumed to be a new standard water heater of same type as the existing unit being replaced, meeting the Federal Standard for ≤75,000 Btuh units and IECC 2021 for all others. If existing type is unknown, assume same water heater type as the efficient unit.

For Residential-sized >55 gallon HPWH tanks, the baseline should assume the same capacity and use the appropriate standard listed below, unless it can be confirmed that the existing tank being replaced was <55 gallon (and the larger tank is only being used to achieve greater efficiency of the heat pump cycle and prevent the unit from going in to resistance mode), in which case the existing unit capacity and the <55 gallon algorithms should be used.

New Construction: The baseline condition is a new standard water heater of the same type as the efficient, meeting the IECC code level in place at the time the building permit was issued. As code requirements and adoption can differ from municipality to municipality, the user should verify which version of code is applicable given these constraints. Note, IECC 2021 became effective statewide on 1/1/2024. IECC 2018 is the requisite code for any projects with permitting dates spanning July 1, 2019 to 12/31/2023. Prior to July 1, 2019, IECC 2015 is the applicable code.

Note the same draw pattern (very small, low, medium and high draw) should be used for both baseline and efficient units. Definitions of draw pattern are provided below.

Equipment Type	Sub Category	Draw Pattern	Federal Standard – Uniform Energy Factor ³⁷⁸
Residential Gas Storage Water Heaters ≤75,000 Btu/h	≤55 gallon tanks	Very small	UEF = 0.3456 – (0.0020 * Rated Storage Volume in Gallons)
		Low	UEF = 0.5982 – (0.0019 * Rated Storage Volume in Gallons)
		Medium	UEF = 0.6483 – (0.0017 * Rated Storage Volume in Gallons)
		High	UEF = 0.6920 – (0.0013 * Rated Storage Volume in Gallons)
		Very small	UEF = 0.6470 – (0.0006 * Rated Storage Volume in Gallons)

³⁷⁸ All Residential sized Federal Standards are from DOE Standard 10 CFR 430, Residential-Duty and Commercial Federal Standard are from DOE Standard 10 CFR 431.

Equipment Type	Sub Category	Draw Pattern	Federal Standard – Uniform Energy Factor ³⁷⁸
	>55 gallon and ≤100 gallon tanks	Low	UEF = 0.7689 – (0.0005 * Rated Storage Volume in Gallons)
		Medium	UEF = 0.7897 – (0.0004 * Rated Storage Volume in Gallons)
		High	UEF = 0.8072 – (0.0003 * Rated Storage Volume in Gallons)
<u>Residential-duty Commercial</u> High Capacity Storage Gas-Fired Storage Water Heaters > 75,000 Btu/h	≤120 gallon tanks	Very small	UEF = 0.2674 – (0.0009 * Rated Storage Volume in Gallons)
		Low	UEF = 0.5362 – (0.0012 * Rated Storage Volume in Gallons)
		Medium	UEF = 0.6002 – (0.0011 * Rated Storage Volume in Gallons)
		High	UEF = 0.6597 – (0.0009 * Rated Storage Volume in Gallons)
<u>Commercial</u> Gas Storage Water Heaters >75,000 Btu/h and ≤155,000 Btu/h	>120 gallon tanks	All	80% E _{thermal} , Standby Losses = (Q /800 + 110vRated Storage Volume in Gallons)
<u>Commercial</u> Gas Storage Water Heaters >155,000 Btu/h			
Residential Gas Instantaneous Water Heaters ≤ 200,000 Btu/h	≤2 gal	Very low	UEF = 0.80
		All other	UEF = 0.81
<u>Commercial Gas</u> Instantaneous Water Heaters > 200,000 Btu/h	<10 gal	All	80% E _{thermal}
	≥10 gal	All	80% E _{thermal}
Residential Electric Storage Water Heaters ≤ 75,000 Btu/h	≤55 gallon tanks	Very small	UEF = 0.8808 – (0.0008 * Rated Storage Volume in Gallons)
		Low	UEF = 0.9254 – (0.0003 * Rated Storage Volume in Gallons)
		Medium	UEF = 0.9307 – (0.0002 * Rated Storage Volume in Gallons)
		High	UEF = 0.9349 – (0.0001 * Rated Storage Volume in Gallons)
	>55 gallon and ≤120 gallon tanks ³⁷⁹	Very small	UEF = 1.9236 – (0.0011 * Rated Storage Volume in Gallons)
		Low	UEF = 2.0440 – (0.0011 * Rated Storage Volume in Gallons)
		Medium	UEF = 2.1171 – (0.0011 * Rated Storage Volume in Gallons)
		High	UEF = 2.2418 – (0.0011 * Rated Storage Volume in Gallons)
Residential Electric Instantaneous Water Heaters	≤12kW and ≤2 gal	All other	UEF = 0.91
		High	UEF = 0.92
<u>Residential-duty Commercial</u> Electric Instantaneous Water Heaters	> 12kW and ≤58.6 kW and ≤2 gal	All	UEF = 0.80

Residential-duty Commercial Water Heaters meet the following criteria:

- Is not designed to provide outlet hot water at temperatures greater than 180 °F; and
- If electric, must use a single-phase external power supply; and
- Gas-fired Storage Water Heater with a rated input no greater than 105 kBtu/h and a DOE Rated Storage volume no greater than 120 gallons.
- Electric Instantaneous with a rated input no greater than 58.6 kW and a DOE Rated Storage volume no greater than 2 gallons.

Draw patterns are based on first hour rating (gallons) for storage tanks and maximum flow (GPM) for instantaneous as shown below:³⁸⁰

³⁷⁹ It is assumed that tanks <75,000Btu/h and >55 gallons will not be eligible measures due to the high baseline.

³⁸⁰ Definitions provided in 10 CFR 430, Subpart B, Appendix E, Section 5.4.1.

Storage Water Heater Draw Pattern	
Draw Pattern	First Hour Rating (gallons)
Very Small	≥ 0 and < 18
Low	≥ 18 and < 51
Medium	≥ 51 and < 75
High	≥ 75

Instantaneous Water Heater Draw Pattern	
Draw Pattern	Max GPM
Very Small	≥ 0 and < 1.7
Low	≥ 1.7 and < 2.8
Medium	≥ 2.8 and < 4
High	≥ 4

DEEMED LIFETIME OF EFFICIENT EQUIPMENT

The expected measure life is assumed to be 15 years for storage³⁸¹ and heat pump units³⁸², 5 years for electric tankless,³⁸³ and 20 years for gas tankless.³⁸⁴

DEEMED MEASURE COST

The full install cost and incremental cost assumptions are provided below. Actual costs should be used where available:

Gas storage water heaters:³⁸⁵

Equipment Type	Category	Install Cost	Incremental Cost
Gas Storage Water Heaters ≤ 75,000 Btu/h, ≤55 Gallons	Baseline	\$616	N/A
	Efficient	\$1,055	\$440
Gas Storage Water Heaters > 75,000 Btu/h	0.80 Et	\$4,886	N/A
	0.83 Et	\$5,106	\$220
	0.84 Et	\$5,299	\$413
	0.85 Et	\$5,415	\$529
	0.86 Et	\$5,532	\$646
	0.87 Et	\$5,648	\$762
	0.88 Et	\$5,765	\$879
	0.89 Et	\$5,882	\$996
	0.90 Et	\$6,021	\$1,135

For electric water heaters, the incremental capital cost for this measure is assumed to be:³⁸⁶

³⁸¹ DEER 08, EUL_Summary_10-1-08.xls.

³⁸² As recommended in Navigant ‘ComEd Effective Useful Life Research Report’, May 2018.

³⁸³ Ohio Technical Reference Manual 8/2/2010 referencing CenterPoint Energy-Triennial CIP/DSM Plan 2010-2012 Report; Additional reference stating >20 years is sourced from the US DOE Energy Savers for Tankless or Demand-Type Water Heaters.

³⁸⁴ Ibid.

³⁸⁵ Cost information is based upon data from “2010-2012 WA017 Ex Ante Measure Cost Study Draft Report”, Itron, February 28, 2014. See “NR HW Heater_WA017_MCS Results Matrix - Volume I.xls” for more information.

³⁸⁶ Act on Energy Commercial Technical Reference Manual, Table 9.6.1-4

Tank Size	Incremental Cost
50 gallons	\$1050
80 gallons	\$1050
100 gallons	\$1950

The incremental capital cost for an electric tankless heater this measure is assumed to be:³⁸⁷

Output (gpm) at delta T 70	Incremental Cost
5	\$1050
10	\$1050
15	\$1950

The incremental capital cost for a gas fired tankless heater is assumed to be³⁸⁸:

Output (gpm) at delta T 70	Incremental Cost
5.0	\$1,500
10.0	\$1,500
15.0	\$2,400

For a heat pump water heater, the incremental installation cost (including labor) should be used. Defaults are provided below.³⁸⁹ Actual efficient costs can also be used although care should be taken as installation costs can vary. For a heat pump water heater, the incremental installation cost (including labor) should be used. Defaults are provided below.³⁹⁰ Actual efficient costs can also be used although care should be taken as installation costs can vary significantly due to complexities of a particular site.

Capacity	Efficiency Range	Baseline Installed Cost	Efficient Installed Cost	Incremental Installed Cost
≤55 gallons	<2.6 UEF	\$1,032	\$2,062	\$1,030
	≥2.6 UEF	\$1,032	\$2,231	\$1,199
>55 gallons	<2.6 UEF	\$1,319	\$2,432	\$1,113
	≥2.6 UEF	\$1,319	\$3,116	\$1,797

LOADSHAPE

For electric hot water heaters, use Loadshape C02 - Commercial Electric DHW.

³⁸⁷ Act on Energy Technical Reference Manual, Table 9.6.2-3

³⁸⁸ Act on Energy Commercial Technical Reference Manual, Table 9.6.3-4. Please see file ‘Ameren C and I TRM.pdf’ for further details.

³⁸⁹ Costs for <2.6 UEF are based upon averages from the NEEP Phase 3 Incremental Cost Study. The assumption for higher efficiency tanks is based upon averaged from NEEP Phase 4 Incremental Cost Study. See ‘HPWH Cost Estimation.xls’ for more information.

³⁹⁰ Costs for <2.6 UEF are based upon averages from the NEEP Phase 3 Incremental Cost Study. The assumption for higher efficiency tanks is based upon averaged from NEEP Phase 4 Incremental Cost Study. See ‘HPWH Cost Estimation.xls’ for more information.

COINCIDENCE FACTOR

The coincidence factor is assumed to be 0.925.³⁹¹

Algorithm

CALCULATION OF SAVINGS

ELECTRIC ENERGY AND FOSSIL FUEL SAVINGS

Non-Fuel Switch Measures:

Electric energy savings are calculated for electric water heaters per the equations given below.

Electric units ≤12 kW:

$$\Delta kWh = \frac{(T_{out} - T_{in}) * HotWaterUse_{Gallon} * \gamma_{Water} * 1 * \left(\frac{1}{UEF_{elecbase}} - \frac{1}{UEF_{Eff}} \right)}{3412} + HPWHWasteHeat_{cool} - HPWHWasteHeat_{heat}$$

Electric units > 12kW:

$$\Delta kWh = \frac{\left((T_{out} - T_{air}) * V * \gamma_{Water} * 1 * \left(\frac{SL_{elecbase} - SL_{eff}}{100} \right) \right) * 8766}{3412}$$

Natural gas energy savings are calculated for natural gas storage water heaters per the equations given below.

$$\Delta Therms = \frac{(T_{out} - T_{in}) * HotWaterUse_{Gallon} * \gamma_{Water} * 1 * \left(\frac{1}{UEF_{gasbase}} - \frac{1}{UEF_{Eff}} \right)}{100,000} - HPWHWasteHeat_{GasHeat}$$

Additional Standby Loss Savings:

Gas Storage Water Heaters >75,000 Btu/h can claim additional savings due to lower standby losses.

$$\Delta Therms_{standby} = \frac{(SL_{gasbase} - SL_{eff}) * 8766}{100,000}$$

Fuel Switch/Electrification Measures:

Fuel switch / electrification measures must produce positive total energy savings (i.e., reduction in Btus at the premises) in order to qualify. This is determined as follows:

Electric units ≤12 kW:

$$SiteEnergySavings \text{ (MMBTUs)} = [GasConsumptionReplaced] - [ElectricConsumptionAdded]$$

³⁹¹ Coincidence factor based on Average W in peak period/Max W from Itron eShape data for Missouri, calibrated to Illinois loads.

$$= \left[\frac{(T_{out} - T_{in}) * HotWaterUse_{Gallon} * \gamma_{Water} * 1 * \left(\frac{1}{UEF_{gasbase}} \right)}{1,000,000} \right] - \left[\frac{(T_{out} - T_{in}) * HotWaterUse_{Gallon} * \gamma_{Water} * 1 * \left(\frac{1}{UEF_{Eff}} \right)}{1,000,000} \right] +$$

$$HPWHWasteHeat_{cool} - HPWHWasteHeat_{heat}$$

Electric units > 12kW and gas units >75,000 Btu/h:

$$SiteEnergySavings \text{ (MMBTUs)} = [GasConsumptionReplaced] - [ElectricConsumptionAdded] + (HPWHWasteHeat_{cool} * 0.003412) - (HPWHWasteHeat_{heat} * ConversionToMMBtu)$$

$$[GasConsumptionReplaced] = \left[\frac{(T_{out} - T_{in}) * HotWaterUse_{Gallon} * \gamma_{Water} * 1 * \left(\frac{1}{UEF_{gasbase}} \right)}{1,000,000} + \frac{(SL_{gasbase} * 8766)}{1,000,000} \right]$$

$$[ElectricConsumptionAdded] = \left[\frac{(T_{out} - T_{in}) * HotWaterUse_{Gallon} * \gamma_{Water} * 1 * \left(\frac{1}{UEF_{Eff}} \right)}{1,000,000} + \frac{\left((T_{out} - T_{air}) * V * \gamma_{Water} * 1 * \left(\frac{SL_{eff}}{100} \right) \right) * 8766}{1,000,000} \right]$$

$$HPWHWasteHeat_{cool} = \left[\frac{\left((T_{OUT} - T_{IN}) * HotWaterUse_{Gallon} * \gamma_{Water} * 1 * \left(1 - \frac{1}{UEF_{Eff}} \right) \right) * LF * 25\% * LM}{COP_{COOL} * 3412} \right] * Cool$$

$$HPWHWasteHeat_{heat} =$$

$$\text{If Electric Heat} = \left[\frac{\left((T_{OUT} - T_{IN}) * HotWaterUse_{Gallon} * \gamma_{Water} * 1 * \left(1 - \frac{1}{UEF_{Eff}} \right) \right) * LF * 35\%}{COP_{HEAT} * 3412} \right] * ElectricHeat$$

$$\text{If Gas Heat} = \left[\frac{\left((T_{OUT} - T_{IN}) * HotWaterUse_{Gallon} * \gamma_{Water} * 1 * \left(1 - \frac{1}{UEF_{Eff}} \right) \right) * LF * 35\%}{100,000 * \eta_{Heat}} \right] * (1 - ElectricHeat)$$

$$ConversionToMMBtu =$$

$$\text{If Electric Heat} = 0.003412 \text{ kWh/MMBtu}$$

$$\text{If Gas Heat} = 0.1 \text{ Therms/MMBtu}$$

If SiteEnergySavings calculated above is positive, the measure is eligible.

The appropriate savings claim is dependent on which utilities are supporting the measure as provided in a table below:

Measure Supported By:	Electric Utility Claims (kWh):	Gas Utility Claims (therms):
Electric utility only	SiteEnergySavings * 1,000,000/3,412	N/A
Electric and gas utility (Note utilities may make alternative agreements to how savings are allocated as long as total MMBtu savings remains the same).	%IncentiveElectric * SiteEnergySavings * 1,000,000/3,412	%IncentiveGas * SiteEnergySavings * 10
Gas utility only	N/A	SiteEnergySavings * 10

Where:

T_{OUT} = Tank temperature
= 125°F

T_{IN} = Incoming water temperature from well or municipal system
= 50.7°F ³⁹²

HotWaterUse_{Gallon} = Estimated annual hot water consumption (gallons)
= Actual if possible to provide reasonable custom estimate. If not, two methodologies are provided to develop an estimate:

- Consumption per usable storage tank capacity
= Capacity * Consumption/cap

Where:

Capacity = Usable capacity of hot water storage tank in gallons
= Actual

Consumption/cap = Estimate of consumption per gallon of usable tank capacity, based on building type.³⁹³

Building Type ³⁹⁴	Consumption/Cap
Convenience	528
Education	568
Grocery	528
Health	788
Large Office	511
Large Retail	528
Lodging	715
Other Commercial	341

³⁹² Table 4 in Chen, et. al., “Calculating Average Hot Water Mixes of Residential Plumbing Fixtures”, June 2020, reports a value of 50.7°F for inlet water temperature for U.S. Census Division 3.

³⁹³ Methodology based on Cadmus analysis. Annual hot water usage in gallons based on CBECS (2012) and RECS (2009) consumption data of East North Central (removed outliers of 1,000 kBtu/h or less) to calculate hot water usage. Annual hot water gallons per tank size gallons based on the tank sizing methodology found in ASHRAE 2011 HVAC Applications. Chapter 50 Service Water Heating. Demand assumptions (gallons per day) for each building type based on ASHRAE Chapter 50 and to LBNL White Paper. LBL-37398 Technology Data Characterizing Water Heating in Commercial Buildings: Application to End Use Forecasting. Assumes hot water heater efficiency of 80%.

³⁹⁴ According to CBECS 2012 “Lodging” buildings include Dormitories, Hotels, Motel or Inns and other Lodging and “Nursing” buildings include Assisted Living and Nursing Homes.

Building Type ³⁹⁴	Consumption/Cap
Restaurant	622
Small Office	511
Small Retail	528
Warehouse	341
Nursing	672
Multi-Family	894
Unknown	555 ³⁹⁵

2. Consumption per unit area by building type
 = (Area/1000) * Consumption/1,000 sq.ft.

Where:

Area = Area in sq.ft that is served by DHW boiler
 = Actual

Consumption/1,000 sq.ft. = Estimate of DHW consumption per 1,000 sq.ft. based on building type:³⁹⁶

Building Type ³⁹⁷	Consumption/1,000 sq.ft.
Convenience	4,594
Education	7,285
Grocery	697
Health	24,540
Large Office	1,818
Large Retail	1,354
Lodging	29,548
Other Commercial	3,941
Restaurant	44,439
Small Office	1,540
Small Retail	6,111
Warehouse	1,239
Nursing	30,503
Multi-Family	15,434

γ_{Water} = Specific weight capacity of water (lb/gal)
 = 8.33 lbs/gal

1 = Specific heat of water (Btu/lb.°F)

UE_{elecbase} = Rated efficiency of baseline water heater expressed as Uniform Energy Factor (UEF);

³⁹⁵ From a historical average of all Ameren Illinois commercial & industrial water heater applications from 2013-2022

³⁹⁶ Methodology based on Cadmus analysis. Annual hot water usage in gallons based on CBECS (2012) and RECS (2009) consumption data of East North Central (removed outliers of 1,000 kBtu/h or less) to calculate hot water usage. Annual hot water gallons per tank size gallons based on the tank sizing methodology found in ASHRAE 2011 HVAC Applications. Chapter 50 Service Water Heating. Demand assumptions (gallons per day) for each building type based on ASHRAE Chapter 50 and to LBNL White Paper. LBL-37398 Technology Data Characterizing Water Heating in Commercial Buildings: Application to End Use Forecasting. Assumes hot water heater efficiency of 80%.

³⁹⁷ According to CBECS 2012 “Lodging” buildings include Dormitories, Hotels, Motel or Inns and other Lodging and “Nursing” buildings include Assisted Living and Nursing Homes.

Note the same draw pattern (very small, low, medium and high draw) should be used for both baseline and efficient units.

Equipment Type	Sub Category	Draw Pattern	Federal Standard – Uniform Energy Factor ³⁹⁸
Residential Electric Storage Water Heaters ≤ 75,000 Btu/h	≤55 gallon tanks	Very small	UEF = 0.8808 – (0.0008 * Rated Storage Volume in Gallons)
		Low	UEF = 0.9254 – (0.0003 * Rated Storage Volume in Gallons)
		Medium	UEF = 0.9307 – (0.0002 * Rated Storage Volume in Gallons)
		High	UEF = 0.9349 – (0.0001 * Rated Storage Volume in Gallons)
	>55 gallon and ≤120 gallon tanks ³⁹⁹	Very small	UEF = 1.9236 – (0.0011 * Rated Storage Volume in Gallons)
		Low	UEF = 2.0440 – (0.0011 * Rated Storage Volume in Gallons)
		Medium	UEF = 2.1171 – (0.0011 * Rated Storage Volume in Gallons)
		High	UEF = 2.2418 – (0.0011 * Rated Storage Volume in Gallons)
Residential Electric Instantaneous Water Heaters	≤12kW and ≤2 gal	All other	UEF = 0.91
		High	UEF = 0.92
Residential-duty Commercial Electric Instantaneous Water Heaters	> 12kW and ≤58.6 kW and ≤2 gal	All	UEF = 0.80

Draw patterns are based on first hour rating (gallons) for storage tanks and maximum flow (GPM) for instantaneous as shown below:⁴⁰⁰

Storage Water Heater Draw Pattern	
Draw Pattern	First Hour Rating (gallons)
Very Small	≥ 0 and < 18
Low	≥ 18 and < 51
Medium	≥ 51 and < 75
High	≥ 75

Instantaneous Water Heater Draw Pattern	
Draw Pattern	Max GPM
Very Small	≥ 0 and < 1.7
Low	≥ 1.7 and < 2.8
Medium	≥ 2.8 and < 4
High	≥ 4

UEF_{eff} = Rated efficiency of efficient water heater expressed as Uniform Energy Factor (UEF)
= Actual

3412 = Converts Btu to kWh

HPWHWasteheat_{cool} = Heat Pump Water Heater Only - Cooling savings from conversion of heat in building to water heat⁴⁰¹

³⁹⁸ All Residential sized Federal Standards are from DOE Standard 10 CFR 430, Residential-Duty and Commercial Federal Standard are from DOE Standard 10 CFR 431.

³⁹⁹ It is assumed that tanks <75,000Btu/h and >55 gallons will not be eligible measures due to the high baseline.

⁴⁰⁰ Definitions provided in 10 CFR 430, Subpart B, Appendix E, Section 5.4.1.

⁴⁰¹ This algorithm calculates the heat removed from the air by subtracting the HPWH electric consumption from the total water heating energy delivered. This is then adjusted to account for location of the HP unit and the coincidence of the waste heat with cooling requirements, the efficiency of the central cooling, and latent cooling demands.

$$= \left[\frac{\left((T_{OUT} - T_{IN}) * HotWaterUse_{Gallon} * \gamma_{Water} * 1 * \left(1 - \frac{1}{UEF_{Eff}} \right) \right) * LF * 25\% * LM}{COP_{COOL} * 3412} \right] * Cool$$

Where:

- LF = Location Factor
= 1.0 for HPWH installation in a conditioned space
= 0.5 for HPWH installation in an unknown location⁴⁰²
= 0.0 for installation in an unconditioned space
- 25% = Portion of reduced waste heat that results in cooling savings⁴⁰³
- COP_{COOL} = COP of Central Air Conditioner
= Actual - If unknown, assume 3.08 (10.5 SEER / 3.412)
- LM = Latent multiplier to account for latent cooling demand
= 1.33⁴⁰⁴
- Cool = 1 if building has central cooling, 0 if not cooled

HPWHWasteheat_{Heat} = Heat Pump Water Heater Only - Heating cost from conversion of heat in building to water heat (dependent on heating fuel)

$$= \left(\frac{\left((T_{OUT} - T_{IN}) * HotWaterUse_{Gallon} * \gamma_{Water} * 1 * \left(1 - \frac{1}{UEF_{Eff}} \right) \right) * LF * 35\%}{COP_{HEAT} * 3412} \right) * ElectricHeat$$

Where:

- 35% = Portion of reduced waste heat that results in increased heating load⁴⁰⁵
- COP_{HEAT} = COP of electric heating system
= Actual system efficiency including duct loss - If not available, use:⁴⁰⁶

⁴⁰² Note unconditioned means a space that is not intentionally heated via furnace vents or boiler radiators. The presence of and/or leakage from a heating system in a space doesn't in itself imply the space is conditioned.

⁴⁰³ This is estimated based on the percentage of lighting savings that result in reduced cooling loads (lighting is used as a proxy for hot water heating since load shapes suggest their seasonal usage patterns are similar). This is based on the WHFe for unknown non-residential buildings (1.08) and assuming an average cooling COP of 3.08 (1.08 = 1 + 0.246/3.08).

⁴⁰⁴ A sensible heat ratio (SHR) of 0.75 corresponds to a latent multiplier of 4/3 or 1.33. SHR of 0.75 for typical split system from page 10 of "Controlling Indoor Humidity Using Variable-Speed Compressors and Blowers" by M. A. Andrade and C. W. Bullard, 1999: www.ideals.illinois.edu/bitstream/handle/2142/11894/TR151.pdf

⁴⁰⁵ This is estimated based on the percentage of lighting savings that result in increased heating loads (lighting is used as a proxy for hot water heating since load shapes suggest their seasonal usage patterns are similar). The WHFh for unknown non-residential buildings is 35%.

⁴⁰⁶ These default system efficiencies are based on the applicable minimum Federal Standards. In 2006 the Federal Standard for Heat Pumps was adjusted. While one would expect the average system efficiency to be higher than this minimum, the likely degradation of efficiencies over time means that using the minimum standard is appropriate. An 85% distribution efficiency is then applied to account for duct losses for heat pumps.

System Type	Age of Equipment	HSPF Estimate	η_{Heat} (Effective COP Estimate) (HSPF/3.412)*0.85
Heat Pump	Before 2006	6.8	1.7
	2006 - 2014	7.7	1.92
	2015 on	8.2	2.04
Resistance	N/A	N/A	1

ElectricHeat = 1 if building is electrically heated, 0 if not

For example, for a 50 gallon, 95% UEF storage unit installed in a 1500 ft² restaurant:

$$\begin{aligned} \Delta\text{kWh} &= ((125 - 50.7) * ((1,500/1,000) * 44,439) * 8.33 * 1 * (1/0.88 - 1/0.95))/3412 + 0 + 0 \\ &= 1012 \text{ kWh} \end{aligned}$$

Electric units > 12kW:

- T_{air} = Ambient Air Temperature
= 70°F
- V = Rated tank volume in gallons
= Actual
- SL_{elecbase} = Standby loss of electric baseline unit (%/hr)
= $0.30 + 27/V$
- SL_{eff} = Nameplate standby loss of new water heater, in BTU/h
8766 = Hours per year

For example, >12kW, 100 gallon storage unit with rated standby loss of 0.5 %/hr:

$$\begin{aligned} SL_{\text{base}} &= 0.3 + (27 / 100) \\ &= 0.57\%/hr \\ \Delta\text{kWh} &= (((125 - 70) * 100 * 8.33 * 1 * (0.57 - 0.5)/100) * 8766)/3412 \\ &= 82.4 \text{ kWh} \end{aligned}$$

Gas units:

- 100,000 = Converts Btu to Therms
- EF_{gasbase} = Rated efficiency of baseline water heater (expressed as Uniform Energy Factor (UEF) or Thermal Efficiency as provided below).

Note the same draw pattern (very small, low, medium and high draw) should be used for both baseline and efficient units.

Equipment Type	Sub Category	Draw Pattern	Federal Standard – Uniform Energy Factor ⁴⁰⁷
Residential Gas Storage Water Heaters ≤75,000 Btu/h	≤55 gallon tanks	Very small	UEF = 0.3456 – (0.0020 * Rated Storage Volume in Gallons)
		Low	UEF = 0.5982 – (0.0019 * Rated Storage Volume in Gallons)
		Medium	UEF = 0.6483 – (0.0017 * Rated Storage Volume in Gallons)
		High	UEF = 0.6920 – (0.0013 * Rated Storage Volume in Gallons)
	>55 gallon and ≤100 gallon tanks	Very small	UEF = 0.6470 – (0.0006 * Rated Storage Volume in Gallons)
		Low	UEF = 0.7689 – (0.0005 * Rated Storage Volume in Gallons)
		Medium	UEF = 0.7897 – (0.0004 * Rated Storage Volume in Gallons)
		High	UEF = 0.8072 – (0.0003 * Rated Storage Volume in Gallons)
Residential-duty Commercial High Capacity Storage Gas-Fired Storage Water Heaters > 75,000 Btu/h	≤120 gallon tanks	Very small	UEF = 0.2674 – (0.0009 * Rated Storage Volume in Gallons)
		Low	UEF = 0.5362 – (0.0012 * Rated Storage Volume in Gallons)
		Medium	UEF = 0.6002 – (0.0011 * Rated Storage Volume in Gallons)
		High	UEF = 0.6597 – (0.0009 * Rated Storage Volume in Gallons)
Commercial Gas Storage Water Heaters >75,000 Btu/h and ≤155,000 Btu/h	>120 gallon tanks	All	80% E _{thermal} , Standby Losses = (Q / 800 + 110V/Rated Storage Volume in Gallons)
Commercial Gas Storage Water Heaters >155,000 Btu/h			
Residential Gas Instantaneous Water Heaters ≤ 200,000 Btu/h	≤2 gal	Very low	UEF = 0.80
		All other	UEF = 0.81
Commercial Gas Instantaneous Water Heaters > 200,000 Btu/h	<10 gal	All	80% E _{thermal}
	≥10 gal	All	78% E _{thermal}

Draw patterns are based on first hour rating (gallons) for storage tanks and maximum flow (GPM) for instantaneous as shown below:⁴⁰⁸

Storage Water Heater Draw Pattern	
Draw Pattern	First Hour Rating (gallons)
Very Small	≥ 0 and < 18
Low	≥ 18 and < 51
Medium	≥ 51 and < 75
High	≥ 75

Instantaneous Water Heater Draw Pattern	
Draw Pattern	Max GPM
Very Small	≥ 0 and < 1.7
Low	≥ 1.7 and < 2.8
Medium	≥ 2.8 and < 4

$HPWH_{WasteHeat_{GasHeat}}$ = Heat Pump Water Heater Only - Heating cost from conversion of heat in building to water heat (dependent on heating fuel)

⁴⁰⁷ All Residential sized Federal Standards are from DOE Standard 10 CFR 430, Residential-Duty and Commercial Federal Standard are from DOE Standard 10 CFR 431.

⁴⁰⁸ Definitions provided in 10 CFR 430, Subpart B, Appendix E, Section 5.4.1.

$$= \left(\frac{\left((T_{OUT} - T_{IN}) * HotWaterUse_{Gallon} * \gamma_{Water} * 1 * \left(1 - \frac{1}{UEF_{Eff}} \right) \right) * LF * 35\%}{100,000 * \eta_{Heat}} \right) * (1 - ElectricHeat)$$

η_{Heat} = Heating system efficiency including duct loss
 = Actual

Where:

$SL_{gasbase}$ = Standby loss of gas baseline unit (Btu/h)
 = $Q/800 + 110\sqrt{V}$
 Q = Nameplate input rating in Btu/h
 V = Rated volume in gallons
 SL_{eff} = Nameplate standby loss of new water heater, in Btu/h
 8766 = Hours per year

For example, for a 200,000 Btu/h, 150 gallon, 90% UEF storage unit with rated standby loss of 1,029 BTU/h installed in a 1,500 ft² restaurant:

$$\begin{aligned} \Delta Therms &= ((125 - 50.7) * ((1,500/1,000) * 44,439) * 8.33 * 1 * (1/0.8 - 1/0.9))/100,000 \\ &= 57.3 Therms \\ \Delta Therms_{Standby} &= (((200,000/800 + 110 * \sqrt{150}) - 1,029) * 8,766)/100,000 \\ &= 49.8 Therms \\ \Delta Therms_{Total} &= 57.3 + 49.8 \\ &= 107.1 Therms \end{aligned}$$

Fuel switch: For example, a 160,000 Btu/h, 120 gallon, 80% UEF storage unit with rated standby loss of 1405 BTU/h installed in a 1500 ft² restaurant (with gas heat 85% AFUE and cooling) is replaced with a 120 gallon HPWH with medium draw (UEF = 2.1171 – (0.0011 * 100) = 2.0) and standby loss rate of 0.5%/hr installed in a unknown location.

$$\begin{aligned} \text{GasConsumptionReplaced} &= (((125 - 50.7) * ((1,500/1,000) * 44,439) * 8.33 * 1 * 1/0.8)/1,000,000) \\ &\quad + ((1,405 * 8,766)/1,000,000) \\ &= 63.8 \text{ MMBtu} \\ \text{ElectricConsumptionAdded} &= (((125 - 50.7) * ((1,500/1,000) * 44,439) * 8.33 * 1 * 1/2.0)/1,000,000) \\ &\quad + (((125 - 50.7) * 120 * 8.33 * 1 * 0.5/100) * 8766)/1,000,000) \\ &= 23.9 \text{ MMBtu} \\ \text{HPWHWasteHeat}_{\text{cool}} &= ((125 - 50.7) * ((1,500/1,000) * 44,439) * 8.33 * 1 * (1 - 1/2.0) * 0.5 * \\ &\quad 0.25 * 1.33) / (3.08 * 3412 * 1) \\ &= 326 \text{ kWh} \\ \text{HPWHWasteHeat}_{\text{GasHeat}} &= ((125 - 50.7) * ((1,500/1,000) * 44,439) * 8.33 * 1 * (1 - 1/2.0) * 0.5 * 0.35) \\ &\quad / (100,000 * 0.85 * 1) \\ &= 42 \text{ Therms} \\ \text{SiteEnergySavings (MMBTUs)} &= 63.8 - 23.9 + (326 * 0.003412) - (42 * 0.1) \\ &= 36.8 \text{ MMBtu} \end{aligned}$$

SUMMER COINCIDENT PEAK DEMAND SAVINGS

$$\Delta kW = \frac{\Delta kWh}{Hours} * CF$$

Where:

- Hours = Full load hours of water heater
= 6,461⁴⁰⁹
- CF = Summer Peak Coincidence Factor for measure
= 0.925⁴¹⁰

For example, >12kW, 100 gallon storage unit with rated standby loss of 0.5 %/hr:

$$\begin{aligned} \Delta kW &= 82.4 / 6,461 * 0.925 \\ &= 0.0118 \text{ kW} \end{aligned}$$

FOSSIL FUEL SAVINGS

Calculation provided together with Electric Energy Savings above.

DEEMED O&M COST ADJUSTMENT CALCULATION

The deemed O&M cost adjustment for a tankless heaters is \$100.⁴¹¹

⁴⁰⁹ Full load hours assumption based on Wh/Max W Ratio from Itron eShape data for Missouri, calibrated to Illinois loads.

⁴¹⁰ Coincidence factor based on Average W in peak period/Max W from Itron eShape data for Missouri, calibrated to Illinois loads.

⁴¹¹ Water heaters (WH) require annual maintenance. There are different levels of effort for annual maintenance depending if the unit is gas or electric, tanked or tankless. Electric and gas tank water heater manufacturers recommend an annual tank

COST EFFECTIVENESS SCREENING AND LOAD REDUCTION FORECASTING WHEN FUEL SWITCHING

This measure can involve fuel switching from fossil fuel to electric.

For the purposes of forecasting load reductions due to fuel switch projects per Section 16-111.5B, changes in site energy use at the customer’s meter (using ΔkWh algorithm below), customer switching estimates, NTG, and any other adjustment factors deemed appropriate, should be used.

The inputs to cost effectiveness screening should reflect the actual impacts on the electric and fuel consumption at the customer meter and, for fuel switching measures, should therefore reflect the decrease in one fuel and increase in another, as opposed to the single savings value calculated in the “Electric and Fossil Fuel Energy Savings” section above. Therefore in addition to the calculation of savings claimed, the following values should be used to assess the cost effectiveness of the measure.

Electric units ≤12 kW:

$$\begin{aligned} \Delta\text{Therms} &= [\text{GasConsumptionReplaced}] \\ &= \left[\frac{(T_{out} - T_{in}) * \text{HotWaterUse}_{\text{Gallon}} * \gamma_{\text{Water}} * 1 * \left(\frac{1}{UEF_{\text{gasbase}}}\right)}{100,000} \right] \\ \Delta\text{kWh} &= [\text{ElectricConsumptionAdded}] \\ &= - \left[\frac{(T_{out} - T_{in}) * \text{HotWaterUse}_{\text{Gallon}} * \gamma_{\text{Water}} * 1 * \left(\frac{1}{UEF_{\text{Eff}}}\right)}{3,412} + \text{HPWHWasteHeat}_{\text{cool}} - \text{HPWHWasteHeat}_{\text{heat}} \right] \end{aligned}$$

Electric units > 12kW and gas units >75,000 Btu/h:

$$\begin{aligned} \Delta\text{Therms} &= [\text{GasConsumptionReplaced}] \\ &= \left[\frac{(T_{out} - T_{in}) * \text{HotWaterUse}_{\text{Gallon}} * \gamma_{\text{Water}} * 1 * \left(\frac{1}{UEF_{\text{gasbase}}}\right)}{100,000} + \frac{(SL_{\text{gasbase}} * 8766)}{100,000} \right] - (\text{HPWHWasteHeat}_{\text{heat(gas)}}) \\ \Delta\text{kWh} &= [\text{ElectricConsumptionAdded}] \\ &= - \left[\frac{(T_{out} - T_{in}) * \text{HotWaterUse}_{\text{Gallon}} * \gamma_{\text{Water}} * 1 * \left(\frac{1}{UEF_{\text{Eff}}}\right)}{1,000,000} + \frac{((T_{out} - T_{air}) * V * \gamma_{\text{Water}} * 1 * \left(\frac{SL_{\text{eff}}}{100}\right)) * 8766}{1,000,000} \right] \\ &\quad + (\text{HPWHWasteHeat}_{\text{cool}} * 0.003412) - (\text{HPWHWasteHeat}_{\text{heat(electric)}}) \end{aligned}$$

drain to clear sediments. Also recommended are “periodic” inspections by qualified service professionals of operating controls, heating element and wiring for electric WHs and thermostat, burner, relief valve internal flue-way and venting systems for gas WHs. Tankless WH require annual maintenance by licensed professionals to clean control compartments, burners, venting system and heat exchangers. This information is from WH manufacturer product brochures including GE, Rinnai, Rheem, Takagi and Kenmore. References for incremental O&M costs were not found. Therefore the incremental cost of the additional annual maintenance for tankless WH is estimated at \$100.

MEASURE CODE: CI-HWE-STWH-V11-240101

REVIEW DEADLINE: 1/1/2027

4.3.2 Low Flow Faucet Aerators

DESCRIPTION

This measure relates to the direct installation of a low flow faucet aerator in a commercial building. Expected applications include small business, office, restaurant, or motel. Health care-specific inputs are defined for Laminar Flow Restrictor (LFR) devices. For multifamily or senior housing, the residential low flow faucet aerator should be used.

This measure was developed to be applicable to the following program types, DI, KITS. If applied to other program types, the measure savings should be verified.

DEFINITION OF EFFICIENT EQUIPMENT

To qualify for this measure the installed equipment must be an energy efficient faucet aerator, for bathrooms rated at 1.5 gallons per minute (GPM) or less, or for kitchens rated at 2.2 GPM or less. For LFR devices, the installed equipment must be a device rated at 2.2 GPM or less. Savings are calculated on an average savings per faucet fixture basis.

DEFINITION OF BASELINE EQUIPMENT

The baseline condition is assumed to be a standard bathroom or kitchen faucet aerator. For LFR devices, the baseline condition is assumed to be no aerator at all, due to the contamination risk caused by faucet aerators in health care facilities and the baseline flow rate is assumed to be 3.74 GPM⁴¹². Note if flow rates are measured, for example through a Direct Install program, then actual baseline flow rates should be used as opposed to the deemed values.

DEEMED LIFETIME OF EFFICIENT EQUIPMENT

The expected measure life is assumed to be 10 years.⁴¹³

DEEMED MEASURE COST

The actual full install cost (including labor) for this measure should be used. If unknown assume \$8 for faucet aerators⁴¹⁴ and \$14.27 for LFR devices.⁴¹⁵

LOADSHAPE

Loadshape C02 - Commercial Electric DHW

COINCIDENCE FACTOR

The coincidence factor for this measure is dependent on building type as presented below.

Algorithm

CALCULATION OF SAVINGS

ELECTRIC ENERGY SAVINGS

Note these savings are *per faucet retrofitted*.⁴¹⁶

$$\Delta kWh = \%ElectricDHW * ((GPM_base - GPM_low)/GPM_base) * Usage * EPG_electric * ISR$$

⁴¹² Workpaper WPCGNRWH150827A, Laminar Flow Restrictors For Hospitals and Health Care Facilities.

⁴¹³ As recommended in Navigant 'ComEd Effective Useful Life Research Report', May 2018.

⁴¹⁴ Direct-install price per faucet assumes cost of aerator and install time. (2011, Market research average of \$3 and assess and install time of \$5 (20min @ \$15/hr).

⁴¹⁵ Direct install price per faucet assumes cost of LFR (\$7.27) and install time (\$7) (Southern California Gas Company, Workpaper WPCGNRWH150827A Revision #0, September, 2015).

⁴¹⁶ This algorithm calculates the amount of energy saved per aerator by determining the fraction of water consumption savings for the upgraded fixture. Due to the distribution of water consumption by fixture type, as well as the different number of fixtures in a building, several variables must be incorporated.

Where:

%ElectricDHW = proportion of water heating supplied by electric resistance heating

DHW Fuel	%Electric_DHW
Electric	100%
Fossil Fuel	0%
Unknown	27.6% ⁴¹⁷

GPM_base = Average flow rate, in gallons per minute, of the baseline faucet “as-used”
 = 1.39,⁴¹⁸ or custom based on metering studies,⁴¹⁹ or, if measured during DI:
 = Measured full throttle flow * 0.83 throttling factor⁴²⁰
 Baseline for LFRs⁴²¹ = 3.74 * 0.83 = 3.10

GPM_low = Average flow rate, in gallons per minute, of the low-flow faucet aerator “as-used”
 = 0.94,⁴²² or custom based on metering studies,⁴²³ or, if measured during DI:
 = Rated full throttle flow * 0.95 throttling factor⁴²⁴
 For LFRs⁴²⁵ = 2.2 * 0.95 = 2.09

Usage = Estimated usage of mixed water (mixture of hot water from water heater line and cold water line) per faucet (gallons per year)
 = If data is available to provide a reasonable custom estimate it should be used; if not, use the following defaults (or substitute custom information in to the calculation):

⁴¹⁷ Based on Applied Energy Group, 2016 'Ameren Illinois Demand Side Management Market Potential Study: Volume 4 – APPENDICES'.

⁴¹⁸ DeOreo, B., and P. Mayer. Residential End Uses of Water Study Update. Forthcoming. ©2015 Water Research Foundation. Reprinted With Permission.

⁴¹⁹ Measurement should be based on actual average flow consumed over a period of time rather than a onetime spot measurement for maximum flow. Studies have shown maximum flow rates do not correspond well to average flow rate due to occupant behavior which does not always use maximum flow.

⁴²⁰ 2008, Schultdt, Marc, and Debra Tachibana. Energy related Water Fixture Measurements: Securing the Baseline for Northwest Single Family Homes. 2008 ACEEE Summer Study on Energy Efficiency in Buildings. Page 1-265.

⁴²¹ Using measured flow rate assumption from Workpaper WPCGNRWH150827A, Laminar Flow Restrictors For Hospitals and Health Care Facilities.

⁴²² Average retrofit flow rate for kitchen and bathroom faucet aerators from sources 2, 4, 5, and 7. This accounts for all throttling and differences from rated flow rates. Assumes all kitchen aerators at 2.2 gpm or less and all bathroom aerators at 1.5 gpm or less. The most comprehensive available studies did not disaggregate kitchen use from bathroom use, but instead looked at total flow and length of use for all faucets. This makes it difficult to reliably separate kitchen water use from bathroom water use. It is possible that programs installing low flow aerators lower than the 2.2 gpm for kitchens and 1.5 gpm for bathrooms will see a lower overall average retrofit flow rate.

⁴²³ Measurement should be based on actual average flow consumed over a period of time rather than a onetime spot measurement for maximum flow. Studies have shown maximum flow rates do not correspond well to average flow rate due to occupant behavior which does not always use maximum flow.

⁴²⁴ 2008, Schultdt, Marc, and Debra Tachibana. Energy related Water Fixture Measurements: Securing the Baseline for Northwest Single Family Homes. 2008 ACEEE Summer Study on Energy Efficiency in Buildings. Page 1-265.

⁴²⁵ Using measured flow rate assumption from Workpaper WPCGNRWH150827A, Laminar Flow Restrictors For Hospitals and Health Care Facilities.

Building Type	Gallons Hot Water per Unit per Day ⁴²⁶ (A)	Unit	Estimated % Hot Water from Faucets ⁴²⁷ (B)	Multiplier ⁴²⁸ (C)	Unit	Days per Year (D)	Annual Gallons Mixed Water per Faucet (A*B*C*D)
Small Office	1	person	100%	10	employees per faucet	250	2,500
Large Office	1	person	100%	45	employees per faucet	250	11,250
Fast Food Rest	0.7	meal/day	50%	75	meals per faucet	365	9,581
Sit-Down Rest	2.4	meal/day	50%	36	meals per faucet	365	15,768
Retail	2	employee	100%	5	employees per faucet	365	3,650
Grocery	2	employee	100%	5	employees per faucet	365	3,650
Warehouse	2	employee	100%	5	employees per faucet	250	2,500
Elementary School	0.6	person	50%	50	students per faucet	200	3,000
Jr High/High School	1.8	person	50%	50	students per faucet	200	9,000
Health	90	patient	25%	2	Patients per faucet	365	16,425
Motel	20	room	25%	1	faucet per room	365	1,825
Hotel	14	room	25%	1	faucet per room	365	1,278
Other	1	employee	100%	20	employees per faucet	250	5,000

- EPG_{electric} = Energy per gallon of mixed water used by faucet (electric water heater)
 = $(8.33 * 1.0 * (\text{WaterTemp} - \text{SupplyTemp})) / (\text{RE}_{\text{electric}} * 3412)$
 = 0.0879 kWh/gal for Bath, 0.1054 kWh/gal for Kitchen, 0.1477 kWh/gal for LFRs, 0.1004 kWh/gal for unknown
- 8.33 = Specific weight of water (lbs/gallon)
- 1.0 = Heat Capacity of water (btu/lb-°F)
- WaterTemp = Assumed temperature of mixed water
 = 86°F for Bath, 93°F for Kitchen, 91°F for Unknown,⁴²⁹ 110°F for health care facilities⁴³⁰
- SupplyTemp = Assumed temperature of water entering building
 = 50.7°F⁴³¹
- RE_{electric} = Recovery efficiency of electric water heater
 = 98%⁴³²

⁴²⁶ Table 2-45 Chapter 49, Service Water Heating, 2007 ASHRAE Handbook, HVAC Applications.

⁴²⁷ Estimated based on data provided in Appendix E; “Waste Not, Want Not: The Potential for Urban Water Conservation in California”, Pacific Institute, November 2003.

⁴²⁸ Based on review of the Illinois plumbing code (Employees and students per faucet). Retail, grocery, warehouse and health are estimates. Meals per faucet estimated as 4 bathroom and 3 kitchen faucets and average meals per day of 250 (based on California study above) – 250/7 = 36. Fast food assumption estimated.

⁴²⁹ Cadmus and Opinion Dynamics Showerhead and Faucet Aerator Meter Study Memorandum dated June 2013, directed to Michigan Evaluation Working Group. If the aerator location is unknown an average of 91% should be used which is based on the assumption that 70% of household water runs through the kitchen faucet and 30% through the bathroom $(0.7*93)+(0.3*86)=0.91$.

⁴³⁰ Southern California Gas Company, Workpaper WPCGNRWH150827A Revision #0, September, 2015.

⁴³¹ Table 4 in Chen, et. al., “Calculating Average Hot Water Mixes of Residential Plumbing Fixtures”, June 2020, reports a value of 50.7°F for inlet water temperature for U.S. Census Division 3.

⁴³² Electric water heaters have recovery efficiency of 98%, as sourced from available products on the AHRI Certification Directory.

3412 = Converts Btu to kWh (Btu/kWh)

ISR = In service rate of faucet aerators dependant on install method as listed in table below:

Selection	ISR
Direct Install - Deemed ⁴³³	0.95
Efficiency Kits - Default ⁴³⁴	0.50
Leave-Behind Kit ⁴³⁵	0.91

For example, a direct installed kitchen faucet in a large office with electric DHW:

$$\begin{aligned} \Delta\text{kWh} &= 1 * ((1.39 - 0.94)/1.39) * 11,250 * 0.1054 * 0.95 \\ &= 364.7 \text{ kWh} \end{aligned}$$

For example, a direct installed bathroom faucet in an Elementary School with electric DHW:

$$\begin{aligned} \Delta\text{kWh} &= 1 * ((1.39 - 0.94)/1.39) * 3,000 * 0.0879 * 0.95 \\ &= 81.1 \text{ kWh} \end{aligned}$$

Secondary kWh Savings for Water Supply and Wastewater Treatment

The following savings should be included in the total savings for this measure, but should not be included in TRC tests to avoid double counting the economic benefit of water savings.

$$\Delta\text{kWh}_{\text{water}} = \Delta\text{Water (gallons)} / 1,000,000 * E_{\text{water total}}$$

Where

$$\begin{aligned} E_{\text{water total}} &= \text{IL Total Water Energy Factor (kWh/Million Gallons)} \\ &= 5,010^{436} \end{aligned}$$

For example, a direct installed faucet in a large office:

$$\begin{aligned} \Delta\text{Water (gallons)} &= ((1.39 - 0.94)/1.39) * 11,250 * 0.95 \\ &= 3,640 \text{ gallons} \\ \Delta\text{kWh}_{\text{water}} &= 3,640/1,000,000 * 5,010 \\ &= 18 \text{ kWh} \end{aligned}$$

SUMMER COINCIDENT PEAK DEMAND SAVINGS

$$\Delta\text{kW} = (\Delta\text{kWh} / \text{Hours}) * \text{CF}$$

Where:

⁴³³ ComEd Energy Efficiency/Demand Response Plan: Plan Year 2 (6/1/2009-5/31/2010) Evaluation Report: All Electric Single Family Home Energy Performance Tune-Up Program, December 21, 2010, Table 3-8.

⁴³⁴ Analysis of CY2018, CY2019, and CY2020 Small Business Kit participant survey installation data. Use if annual survey data is not available or applicable. Please see file "SB Kits Survey Analysis TRMv10 Support.xlsx"

⁴³⁵ Based on DCEO STEP Program GPY5 evaluation report for showerheads and aerators. Guidehouse, *In-Service Rates for a CY2020 Business Remote Assessment Path for Customer Installed Measures*, August 21, 2020. Please see file "Business Program Remote Assessment and Install ISR Memo 2020-08-21.docx"

⁴³⁶ This factor include 2571 kWh/MG for water supply based on Illinois energy intensity data from a 2012 ISAWWA study and 2439 kWh/MG for wastewater treatment based on national energy intensity use estimates. For more information please review Elevate Energy's 'IL TRM: Energy per Gallon Factor, May 2018 paper'.

Δ kWh = calculated value above on a per faucet basis. Note do not include the secondary savings in this calculation.

Hours = Annual electric DHW recovery hours for faucet use

$$= (\text{Usage} * 0.44^{437}) / \text{GPH}$$

= Calculate if usage is custom, if using default usage use:

Building Type	Annual Recovery Hours
Small Office	20
Large Office	92
Fast Food Rest	78
Sit-Down Rest	129
Retail	30
Grocery	30
Warehouse	20
Elementary School	24
Jr High/High School	73
Health	134
Motel	15
Hotel	10
Other	41

Where:

GPH = Gallons per hour recovery of electric water heater calculated for 89.3F temp rise (140-50.7), 98% recovery efficiency, and typical 12kW electric resistance storage tank.

$$= 53.9$$

CF = Coincidence Factor for electric load reduction

$$= \text{Dependent on building type}^{438}$$

Building Type	Coincidence Factor
Small Office	0.0064
Large Office	0.0288
Fast Food Rest	0.0084
Sit-Down Rest	0.0184
Retail	0.0043
Grocery	0.0043
Warehouse	0.0064
Elementary School	0.0096
Jr High/High School	0.0288
Health	0.0144
Motel	0.0006

⁴³⁷ 44% is the proportion of hot 140°F water mixed with 50.7°F supply water to give 90°F mixed faucet water.

⁴³⁸ Calculated as follows: Assumptions for percentage of usage during peak period (1-5pm) were made and then multiplied by 65/365 (65 being the number of days in peak period) and by the number of total annual recovery hours to give an estimate of the number of hours of recovery during peak periods. There are 260 hours in the peak period so the probability you will see savings during the peak period is calculated as the number of hours of recovery during peak divided by 260. See 'C&I Faucet Aerator.xls' for details.

Building Type	Coincidence Factor
Hotel	0.0004
Other	0.0128

For example, a direct installed kitchen faucet in a large office with electric DHW:
 $\Delta kW = 364.7/92 * 0.0288$
 $= 0.1142 \text{ kW}$

For example, a direct installed bathroom faucet in an Elementary School with electric DHW:
 $\Delta kW = 81.1/24 * 0.0096$
 $= 0.0324 \text{ kW}$

FOSSIL FUEL SAVINGS

$$\Delta \text{Therms} = \% \text{FossilDHW} * ((\text{GPM}_{\text{base}} - \text{GPM}_{\text{low}}) / \text{GPM}_{\text{base}}) * \text{Usage} * \text{EPG}_{\text{gas}} * \text{ISR}$$

Where:

$\% \text{FossilDHW}$ = proportion of water heating supplied by fossil fuel heating

DHW Fuel	$\% \text{Fossil}_{\text{DHW}}$
Electric	0%
Fossil Fuel	100%
Unknown	72.4% ⁴³⁹

EPG_{gas} = Energy per gallon of mixed water used by faucet (gas water heater)
 $= (8.33 * 1.0 * (\text{WaterTemp} - \text{SupplyTemp})) / (\text{RE}_{\text{gas}} * 100,000)$
 = 0.0044 Therm/gal for Bath, 0.0053 Therm/gal for Kitchen, 0.0074 Therm/gal for LFRs, 0.0050 Therm/gal for unknown

Where:

RE_{gas} = Recovery efficiency of gas water heater
 = 67%⁴⁴⁰

100,000 = Converts Btus to Therms (Btu/Therm)

Other variables as defined above.

⁴³⁹ Based on Applied Energy Group, 2016 'Ameren Illinois Demand Side Management Market Potential Study: Volume 4 – APPENDICES'.

⁴⁴⁰ Review of AHRI Directory suggests range of recovery efficiency ratings for new Gas DHW units of 70-87%. Average of existing units is estimated at 75%. Commercial properties are more similar to MF homes than SF homes. MF hot water is often provided by a larger commercial boiler. This suggests that the average recovery efficiency is somewhere between a typical central boiler efficiency of .59 and the .75 for single family home. An average is used for this analysis by default.

For example, a direct installed kitchen faucet in a large office with gas DHW:

$$\Delta\text{Therms} = 1 * ((1.39 - 0.94)/1.39) * 11,250 * 0.0053 * 0.95$$

$$= 18.3 \text{ Therms}$$

For example, a direct installed bathroom faucet in an Elementary School with gas DHW:

$$\Delta\text{Therms} = 1 * ((1.39 - 0.94)/1.39) * 3,000 * 0.0044 * 0.95$$

$$= 4.06 \text{ Therms}$$

WATER IMPACT DESCRIPTIONS AND CALCULATION

$$\Delta\text{Water (gallons)} = ((\text{GPM}_{\text{base}} - \text{GPM}_{\text{low}})/\text{GPM}_{\text{base}}) * \text{Usage} * \text{ISR}$$

Variables as defined above.

For example, a direct installed faucet in a large office:

$$\Delta\text{Water (gallons)} = ((1.39 - 0.94)/1.39) * 11,250 * 0.95$$

$$= 3,640 \text{ gallons}$$

For example, a direct installed faucet in an Elementary School:

$$\Delta\text{Water (gallons)} = ((1.39 - 0.94)/1.39) * 3,000 * 0.95$$

$$= 971 \text{ gallons}$$

DEEMED O&M COST ADJUSTMENT CALCULATION

N/A

SOURCES USED FOR GPM ASSUMPTIONS

Source ID	Reference
1	2011, DeOreo, William. California Single Family Water Use Efficiency Study. April 20, 2011.
2	2000, Mayer, Peter, William DeOreo, and David Lewis. Seattle Home Water Conservation Study. December 2000.
3	1999, Mayer, Peter, William DeOreo. Residential End Uses of Water. Published by AWWA Research Foundation and American Water Works Association. 1999.
4	2003, Mayer, Peter, William DeOreo. Residential Indoor Water Conservation Study. Aquacraft, Inc. Water Engineering and Management. Prepared for East Bay Municipal Utility District and the US EPA. July 2003.
5	2011, DeOreo, William. Analysis of Water Use in New Single Family Homes. By Aquacraft. For Salt Lake City Corporation and US EPA. July 20, 2011.
6	2011, Aquacraft. Albuquerque Single Family Water Use Efficiency and Retrofit Study. For Albuquerque Bernalillo County Water Utility Authority. December 1, 2011.
7	2008, Schuldt, Marc, and Debra Tachibana. Energy related Water Fixture Measurements: Securing the Baseline for Northwest Single Family Homes. 2008 ACEEE Summer Study on Energy Efficiency in Buildings.

MEASURE CODE: CI-HWE-LFFA-V12-240101

REVIEW DEADLINE: 1/1/2026

4.3.3 Low Flow Showerheads

DESCRIPTION

This measure relates to the direct installation of a low flow showerhead in a commercial building. Expected applications include small business, office, restaurant, or small motel. For multifamily or senior housing, the residential low flow showerhead should be used.

This measure was developed to be applicable to the following program types: DI. If applied to other program types, the measure savings should be verified.

DEFINITION OF EFFICIENT EQUIPMENT

To qualify for this measure the installed equipment must be an energy efficient showerhead rated at 2.0 gallons per minute (GPM) or less. Savings are calculated on a per showerhead fixture basis.

DEFINITION OF BASELINE EQUIPMENT

The baseline condition is assumed to be a standard showerhead rated at 2.5 GPM.

DEEMED LIFETIME OF EFFICIENT EQUIPMENT

The expected measure life is assumed to be 10 years.⁴⁴¹

DEEMED MEASURE COST

The actual full install cost (including labor) should be used. If unknown, assume \$12 per showerhead.⁴⁴²

LOADSHAPE

Loadshape C02 - Commercial Electric DHW

COINCIDENCE FACTOR

The coincidence factor for this measure is assumed to be 2.78%.⁴⁴³

Algorithm

CALCULATION OF SAVINGS⁴⁴⁴

ELECTRIC ENERGY SAVINGS

Note these savings are per showerhead fixture.

$$\Delta kWh =$$

$$\%ElectricDHW * ((GPM_base * L_base - GPM_low * L_low) * NSPD * 365.25) * EPG_electric * ISR$$

Where:

$$\%ElectricDHW = \text{proportion of water heating supplied by electric resistance heating}$$

⁴⁴¹ Table C-6, Measure Life Report, Residential and Commercial/Industrial Lighting and HVAC Measures, GDS Associates, June 2007. Evaluations indicate that consumer dissatisfaction may lead to reductions in persistence, particularly in Multi-Family.

⁴⁴² Direct-install price per showerhead assumes cost of showerhead (Market research average of \$7 and assess and install time of \$5 (20min @ \$15/hr).

⁴⁴³ Calculated as follows: Assume 11% showers take place during peak hours (as sourced from “Analysis of Water Use in New Single Family Homes, Aquacraft Water Engineering and Management, January 2011). There are 65 days in the summer peak period, so the percentage of total annual aerator use in peak period is $0.11 * 65 / 365 = 1.96\%$. The number of hours of recovery during peak periods is therefore assumed to be $1.96\% * 369 = 7.23$ hours of recovery during peak period. There are 260 hours in the peak period, so the probability you will see savings during the peak period is $7,23 / 260 = 0.0278$.

⁴⁴⁴Based on excel spreadsheet 120911.xls ...on IL-TRM SharePoint.

= 1 if electric DHW; 0 if fuel DHW; if unknown, assume 27.6% ⁴⁴⁵

GPM_base = Flow rate of the baseline showerhead
 = 2.67 for Direct-install programs⁴⁴⁶

GPM_low = As-used flow rate of the low flow showerhead, which may, as a result of measurements of program evaluations deviate from rated flows, see table below:

Rated Flow
2.0 GPM
1.75 GPM
1.5 GPM
Custom or Actual ⁴⁴⁷

L_base = Shower length in minutes with baseline showerhead
 = 8.20 min⁴⁴⁸

L_low = Shower length in minutes with low-flow showerhead
 = 8.20 min⁴⁴⁹

365.25 = Days per year, on average.

NSPD = Estimated number of showers taken per day for one showerhead

EPG_electric = Energy per gallon of hot water supplied by electric
 = $(8.33 * 1.0 * (\text{ShowerTemp} - \text{SupplyTemp})) / (\text{RE_electric} * 3412)$
 = $(8.33 * 1.0 * (101 - 50.7)) / (0.98 * 3412)$
 = 0.125 kWh/gal

8.33 = Specific weight of water (lbs/gallon)

1.0 = Heat Capacity of water (btu/lb-°F)

ShowerTemp = Assumed temperature of water
 = 101°F ⁴⁵⁰

SupplyTemp = Assumed temperature of water entering house
 = 50.7°F ⁴⁵¹

⁴⁴⁵ Based on Applied Energy Group, 2016 'Ameren Illinois Demand Side Management Market Potential Study: Volume 4 – APPENDICES'.

⁴⁴⁶ Based on measured data from Ameren IL EM&V of Direct-Install program. Program targets showers that are rated 2.5 GPM or above.

⁴⁴⁷ Note that actual values may be either a) program-specific minimum flow rate, or b) program-specific evaluation-based value of actual effective flow-rate due to increased duration or temperatures. The latter increases in likelihood as the rated flow drops and may become significant at or below rated flows of 1.5 GPM. The impact can be viewed as the inverse of the throttling described in the footnote for baseline flowrate.

⁴⁴⁸ Representative value from sources 1, 2, 3, 4, 5, and 6 (See Source Table at end of measure section).

⁴⁴⁹ Set equal to L_base.

⁴⁵⁰ Cadmus and Opinion Dynamics Showerhead and Faucet Aerator Meter Study Memorandum dated June 2013, directed to Michigan Evaluation Working Group.

⁴⁵¹ Table 4 in Chen, et. al., "Calculating Average Hot Water Mixes of Residential Plumbing Fixtures", June 2020, reports a value of 50.7°F for inlet water temperature for U.S. Census Division 3.

- RE_electric = Recovery efficiency of electric water heater
= 98%⁴⁵²
- 3412 = Converts Btu to kWh (btu/kWh)
- ISR = In service rate of showerhead
= Dependant on program delivery method as listed in table below

Selection	ISR
Direct Install or Guided Self-Install	0.98 ⁴⁵³
Leave-Behind Kit	0.94 ⁴⁵⁴

For example, a direct-installed 1.5 GPM showerhead in an office with electric DHW where the number of showers is estimated at 3 per day:

$$\begin{aligned} \Delta kWh &= 1 * ((2.67*8.20) - (1.5*8.20)) * 3 * 365.25 * 0.125 * 0.98 \\ &= 1288 \text{ kWh} \end{aligned}$$

Secondary kWh Savings for Water Supply and Wastewater Treatment

The following savings should be included in the total savings for this measure but should not be included in TRC tests to avoid double counting the economic benefit of water savings.

$$\Delta kWh_{\text{water}} = \Delta \text{Water (gallons)} / 1,000,000 * E_{\text{water total}}$$

Where

$$\begin{aligned} E_{\text{water total}} &= \text{IL Total Water Energy Factor (kWh/Million Gallons)} \\ &= 5,010^{455} \end{aligned}$$

For example, a direct-installed 1.5 GPM showerhead in an office with where the number of showers is estimated at 3 per day:

$$\begin{aligned} \Delta \text{Water (gallons)} &= ((2.67 * 8.20) - (1.5 * 8.20)) * 3 * 365.25 * 0.98 \\ &= 10,302 \text{ gallons} \\ \Delta kWh_{\text{water}} &= 10,302 / 1,000,000 * 5,010 \\ &= 52 \text{ kWh} \end{aligned}$$

SUMMER COINCIDENT PEAK DEMAND SAVINGS

$$\Delta kW = \Delta kWh / \text{Hours} * CF$$

Where:

⁴⁵² Electric water heaters have recovery efficiency of 98%, as sourced from available products on the AHRI Certification Directory.

⁴⁵³ Deemed values are from ComEd Energy Efficiency/ Demand Response Plan: Plan Year 2 (6/1/2009-5/31/2010) Evaluation Report: All Electric Single Family Home Energy Performance Tune-Up Program Table 3-8. Alternative ISRs may be developed for program delivery methods based on evaluation results.

⁴⁵⁴ Based on DCEO STEP Program GPY5 evaluation report for showerheads and aerators. Guidehouse, *In-Service Rates for a CY2020 Business Remote Assessment Path for Customer Installed Measures*, August 21, 2020.

⁴⁵⁵ This factor include 2571 kWh/MG for water supply based on Illinois energy intensity data from a 2012 ISAWWA study and 2439 kWh/MG for wastewater treatment based on national energy intensity use estimates. For more information please review Elevate Energy’s ‘IL TRM: Energy per Gallon Factor, May 2018 paper’.

ΔkWh = calculated value above. Note do not include the secondary savings in this calculation.

Hours = Annual electric DHW recovery hours for showerhead use
 = $((GPM_base * L_base) * NSPD * 365.25) * 0.608^{456} / GPH$

Where:

GPH = Gallons per hour recovery of electric water heater calculated for 89.3F temp rise (140-50.7), 98% recovery efficiency, and typical 12kW electric resistance storage tank.

= 53.9

CF = Coincidence Factor for electric load reduction

= 0.0278⁴⁵⁷

For example, a direct-installed 1.5 GPM showerhead in an office with electric DHW where the number of showers is estimated at 3 per day:

$$\Delta kW = (1288 / 271) * 0.0278$$

$$= 0.132 \text{ kW}$$

FOSSIL FUEL SAVINGS

$\Delta Therms = \%FossilDHW * ((GPM_base * L_base - GPM_low * L_low) * NSPD * 365.25) * EPG_gas * ISR$

Where:

$\%FossilDHW$ = proportion of water heating supplied by fossil fuel heating

DHW Fuel	$\%Fossil_DHW$
Electric	0%
Fossil Fuel	100%
Unknown	72.4% ⁴⁵⁸

EPG_gas = Energy per gallon of Hot water supplied by gas
 = $(8.33 * 1.0 * (ShowerTemp - SupplyTemp)) / (RE_gas * 100,000)$
 = 0.0063 Therm/gal

Where:

RE_gas = Recovery efficiency of gas water heater

⁴⁵⁶ 60.8% is the proportion of hot 140°F water mixed with 50.7°F supply water to give 105°F shower water.

⁴⁵⁷ Calculated as follows: Assume 11% showers take place during peak hours (as sourced from “Analysis of Water Use in New Single Family Homes, Aquacraft Water Engineering and Management, January 2011). There are 65 days in the summer peak period, so the percentage of total annual aerator use in peak period is $0.11 * 65 / 365.25 = 1.96\%$. The number of hours of recovery during peak periods is therefore assumed to be $1.96\% * 369 = 7.23$ hours of recovery during peak period where 369 equals the average annual electric DHW recovery hours for showerhead use including SF and MF homes with Direct Install and Retrofit/TOS measures. There are 260 hours in the peak period so the probability you will see savings during the peak period is $7.23 / 260 = 0.0278$.

⁴⁵⁸ Based on Applied Energy Group, 2016 'Ameren Illinois Demand Side Management Market Potential Study: Volume 4 – APPENDICES'.

$$100,000 = 67\%^{459} = \text{Converts Btus to Therms (btu/Therm)}$$

Other variables as defined above.

For example, a direct-installed 1.5 GPM showerhead in an office with gas DHW where the number of showers is estimated at 3 per day:

$$\Delta\text{Therms} = 1.0 * ((2.67 * 8.2) - (1.5 * 8.2)) * 3 * 365.25 * 0.0063 * 0.98$$

$$= 64.9 \text{ therms}$$

WATER IMPACT DESCRIPTIONS AND CALCULATION

$$\Delta\text{Water (gallons)} = ((\text{GPM}_{\text{base}} * L_{\text{base}} - \text{GPM}_{\text{low}} * L_{\text{low}}) * \text{NSPD} * 365.25 * \text{ISR})$$

Variables as defined above

For example, a direct-installed 1.5 GPM showerhead in an office with where the number of showers is estimated at 3 per day:

$$\Delta\text{Water (gallons)} = ((2.67 * 8.20) - (1.5 * 8.20)) * 3 * 365.25 * 0.98$$

$$= 10,302 \text{ gallons}$$

DEEMED O&M COST ADJUSTMENT CALCULATION

N/A

SOURCES

Source ID	Reference
1	2011, DeOreo, William. California Single Family Water Use Efficiency Study. April 20, 2011.
2	2000, Mayer, Peter, William DeOreo, and David Lewis. Seattle Home Water Conservation Study. December 2000.
3	1999, Mayer, Peter, William DeOreo. Residential End Uses of Water. Published by AWWA Research Foundation and American Water Works Association. 1999.
4	2003, Mayer, Peter, William DeOreo. Residential Indoor Water Conservation Study. Aquacraft, Inc. Water Engineering and Management. Prepared for East Bay Municipal Utility District and the US EPA. July 2003.
5	2011, DeOreo, William. Analysis of Water Use in New Single Family Homes. By Aquacraft. For Salt Lake City Corporation and US EPA. July 20, 2011.
6	2011, Aquacraft. Albuquerque Single Family Water Use Efficiency and Retrofit Study. For Albuquerque Bernalillo County Water Utility Authority. December 1, 2011.
7	2008, Schultdt, Marc, and Debra Tachibana. Energy related Water Fixture Measurements: Securing the Baseline for Northwest Single Family Homes. 2008 ACEEE Summer Study on Energy Efficiency in Buildings.

⁴⁵⁹ Review of AHRI Directory suggests range of recovery efficiency ratings for new Gas DHW units of 70-87%. Average of existing units is estimated at 75%. Commercial properties are more similar to MF homes than SF homes. MF hot water is often provided by a larger commercial boiler. This suggests that the average recovery efficiency is somewhere between a typical central boiler efficiency of .59 and the .75 for single family home. An average is used for this analysis by default.

MEASURE CODE: CI-HWE-LFSH-V09-250101

REVIEW DEADLINE: 1/1/2029

4.3.4 Commercial Pool Covers

DESCRIPTION

This measure refers to the installation of covers on commercial use pools that are heated with gas-fired equipment located either indoors or outdoors. By installing pool covers, the heating load on the pool boiler will be reduced by reducing the heat loss from the water to the environment and the amount of actual water lost due to evaporation (which then requires additional heated water to make up for it). An additional benefit to pool covers are the electricity savings from the reduced fresh water required to replace the evaporated water.

The main source of energy loss in pools is through evaporation. This is particularly true of outdoor pools where wind plays a larger role. The point of installing pool covers is threefold. First, it will reduce convective losses due to the wind by shielding the water surface. Second, it will insulate the water from the colder surrounding air. And third, it will reduce radiative losses to the night sky. In doing so, evaporative losses will also be minimized, and the boiler will not need to work as hard in replenishing the pool with hot water to keep the desired temperature.

This measure can be used for pools that (1) currently do not have pool covers, (2) have pool covers that are past the useful life of the existing cover, or (3) have pool covers that are past their warranty period and have failed. Please note, IECC 2021 requires pool covers in outdoor applications, making this measure ineligible for new construction projects with outdoor pools. IECC 2021 has become effective statewide as of January 1, 2024, and is the baseline for all New Construction permits from that date onward. As code requirements and adoption can differ from municipality to municipality, the user should verify which version of code is applicable given these constraints.

DEFINITION OF EFFICIENT EQUIPMENT

For indoor pools, the efficient case is the installation of an indoor pool cover with a 5 year warranty on an indoor pool that operates all year.

For outdoor pools, the efficient case is the installation of an outdoor pool cover with a 5 year warranty on an outdoor pool that is open through the summer season.

DEFINITION OF BASELINE EQUIPMENT

For indoor pools, the base case is an uncovered indoor pool that operates all year.

For outdoor pools, the base case is an outdoor pool that is uncovered and is open through the summer season.

DEEMED LIFETIME OF EFFICIENT EQUIPMENT

The useful life of this measure is assumed to be 6 years.⁴⁶⁰

DEEMED MEASURE COST

The table below shows the costs for the various options and cover sizes. Since this measure covers a mix of various sizes, the average cost of these options is taken to be the incremental measure cost.⁴⁶¹ Costs are per square foot.

⁴⁶⁰ The effective useful life of a pool cover is typically one year longer than its warranty period. SolaPool Covers. Pool Covers Website, FAQ- "How long will my SolaPool cover blanket last?". Pool covers are typically offered with 3 and 5 year warranties with at least one company offering a 6 year warranty. Conversation with Trade Ally. Knorr Systems.

⁴⁶¹ Pool Cover Costs: Lincoln Commercial Pool Equipment online catalog. Accessed 8/26/11.

Cover Size	Edge Style	
	Hemmed (indoor)	Weighted (outdoor)
1000-1,999 sq. ft.	\$2.19	\$2.24
2,000-2,999 sq. ft.	\$2.01	\$2.06
3,000+ sq. ft.	\$1.80	\$1.83
Average	\$2.00	\$2.04

LOADSHAPE

Loadshape R15 – Residential Pool Pumps

COINCIDENCE FACTOR

N/A

Algorithm

CALCULATION OF ENERGY SAVINGS

ELECTRIC ENERGY SAVINGS

Secondary kWh Savings for Water Supply and Wastewater Treatment

The following savings should be included in the total savings for this measure but should not be included in TRC tests to avoid double counting the economic benefit of water savings.

$$\Delta kWh_{water} = \Delta Water \text{ (gallons)} / 1,000,000 * E_{water \text{ supply}}$$

Where

$$E_{water \text{ supply}} = \text{Water Supply Energy Factor (kWh/Million Gallons)}$$

$$= 2,571^{462}$$

For example,

2400ft² Indoor Swimming Pool:

$$\begin{aligned} \Delta Water &= \text{WaterSavingFactor} \times \text{Size of Pool} \\ &= 15.28 \text{ gal./ft}^2/\text{year} \times 2400 \text{ ft}^2 \\ &= 36,672 \text{ gal./year} \end{aligned}$$

$$\begin{aligned} \Delta kWh_{water} &= \Delta Water / 1,000,000 * E_{water \text{ supply}} \\ &= 36,672 \text{ gal./year} / 1,000,000 * 2,571 \text{ kWh/million gallons} \\ &= 96.3 \text{ kWh/year} \end{aligned}$$

2400ft² Outdoor Swimming Pool:

$$\begin{aligned} \Delta Water &= \text{WaterSavingFactor} \times \text{Size of Pool} \\ &= 8.94 \text{ gal./ft}^2/\text{year} \times 2400 \text{ ft}^2 \\ &= 21,456 \text{ gal./year} \end{aligned}$$

$$\begin{aligned} \Delta kWh_{water} &= \Delta Water / 1,000,000 * E_{water \text{ supply}} \\ &= 21,456 \text{ gal./year} / 1,000,000 * 2,571 \text{ kWh/million gallons} \\ &= 55.2 \text{ kWh/year} \end{aligned}$$

⁴⁶² This factor include 2571 kWh/MG for water supply based on Illinois energy intensity data from a 2012 ISAWWA study. For more information please review Elevate Energy’s ‘IL TRM: Energy per Gallon Factor, May 2018 paper’. Note since the water loss associated with this measure is due to evaporation and does not discharge into the wastewater system, only the water supply factor is used here.

SUMMER COINCIDENT PEAK DEMAND SAVINGS

N/A

FOSSIL FUEL SAVINGS

The calculations are based on modeling runs using RSPEC! Energy Smart Pools Software that was created by the U.S. Department of Energy.⁴⁶³

$$\Delta\text{Therms} = \text{SavingFactor} \times \text{Size of Pool}$$

Where

Savings factor = dependant on pool location and listed in table below.⁴⁶⁴

Location	Therm / sq-ft
Indoor	2.61
Outdoor	1.01

Size of Pool = custom input

WATER IMPACT DESCRIPTIONS AND CALCULATION

$$\Delta\text{Water (gallons)} = \text{WaterSavingFactor} \times \text{Size of Pool}$$

Where

WaterSavingFactor = Water savings for this measure dependant on pool location and listed in table below.⁴⁶⁵

Location	Annual Savings Gal / sq-ft
Indoor	15.28
Outdoor	8.94

Size of Pool = Custom input

DEEMED O&M COST ADJUSTMENT CALCULATION

There are no O&M cost adjustments for this measure.

MEASURE CODE: CI-HWE-PLCV-V06-250101

REVIEW DEADLINE: 1/1/2029

⁴⁶³ Full method and supporting information found in reference document: IL TRM - Business Pool Covers WorkPaper.docx. Note that the savings estimates are based upon Chicago weather data.

⁴⁶⁴ Business Pool Covers.xlsx

⁴⁶⁵ Ibid.

4.3.5 Tankless Water Heater – Measure combined with 4.3.1 Water Heater in Version 8

4.3.6 Ozone Laundry

DESCRIPTION

A new ozone laundry system(s) is added-on to new or existing commercial washing machine(s) using hot water heated with natural gas. The system generates ozone (O₃), a naturally occurring molecule, which helps clean fabrics by chemically reacting with soils in cold water. Adding an ozone laundry system(s) will reduce the amount of chemicals, detergents, and hot water needed to wash linens. Using ozone also reduces the total amount of water consumed, saving even more in energy.

Natural gas energy savings will be achieved at the hot water heater/boiler as they will be required to produce less hot water to wash each load of laundry. The decrease in hot water usage will increase cold water usage, but overall water usage at the facility will decrease.

Electric savings can be realized through reduced washer cycle length and reduced pumping load at the boiler feeding the commercial washers. The increased usage associated with operating the ozone system should also be accounted for when determining total kWh impact. Data reviewed for this measure characterization indicated that pumping savings should be accounted for, but washer savings and ozone generator consumption are comparatively so small that they can be ignored.

The reduced washer cycle length may decrease the dampness of the clothes when they move to the dryer. This can result in shorter runtimes which result in gas and electrical savings. However, at this time, there is inconclusive evidence that energy savings are achieved from reduced dryer runtimes so the resulting dryer effects are not included in this analysis. Additionally, there would be challenges verifying that dryer savings will be achieved throughout the life of the equipment.

This incentive only applies to the following facilities with on-premise laundry operations:

- Hotels/motels
- Fitness and recreational sports centers.
- Healthcare (excluding hospitals)
- Assisted living facilities
- Laundromats

Ozone laundry system(s) could create significant energy savings opportunities at other larger facility types with on-premise laundry operations (such as correctional facilities, universities, and staff laundries), however, the results included in this analysis are based heavily on past project data for the applicable facility types listed above and may not apply to facilities outside of this list due to variances in number of loads and average pound (lbs.)-capacity per project site. Projects at these facilities should continue to be evaluated through custom programs and the applicable facility types and the resulting analysis should be updated based on new information.

Laundromats are the only application where number of washing units needs to be used to calculate total site energy savings. All other applications use site assumptions to calculate total site savings.

This measure was developed to be applicable to the following program types: TOS, RF. If applied to other program types, the measure savings should be verified.

DEFINITION OF EFFICIENT EQUIPMENT

A new ozone laundry system(s) is added-on to new or existing commercial washing machine(s) using hot water heated with natural gas. The ozone laundry system(s) must transfer ozone into the water through:

- Venturi Injection
- Bubble Diffusion
- Additional applications may be considered upon program review and approval on a case by case basis
- For laundromats, the ozone laundry system(s) must be connected to both the hot and cold water inlets of the clothes washing machine(s) so that hot water is no longer provided to the clothes washer.

DEFINITION OF BASELINE EQUIPMENT

The base case equipment is a conventional washing machine system with no ozone generator installed. The washing machines are provided hot water from a gas-fired boiler.

DEEMED LIFETIME OF EFFICIENT EQUIPMENT

The measure equipment effective useful life (EUL) is estimated at 10 years based on typical lifetime of the ozone generator’s corona discharge unit.⁴⁶⁶

DEEMED MEASURE COST

The actual measure costs should be used if available. If not, the following deemed values should be used:

Application	Deemed Measure Cost
Laundromat	\$25.53 / lbs capacity ⁴⁶⁷
Hotel/Motel	\$79.84 / lbs capacity ⁴⁶⁸
Fitness and Recreation	
Healthcare	
Assisted Living	

LOADSHAPE

Loadshape C53 – Flat

COINCIDENCE FACTOR

Past project documentation and data collection is not sufficient to determine a coincidence factor for this measure. Value should continue to be studied and monitored through additional studies due to limited data points used for this determination.

Algorithm

CALCULATION OF ENERGY SAVINGS

ELECTRIC ENERGY SAVINGS

Electric savings can be realized through reduced washer cycle length and reduced pumping load at the boiler feeding the commercial washers. There is also an increased usage associated with operating the ozone system. Data reviewed for this measure characterization indicated that while pumping savings is significant and should be accounted for, washer savings and ozone generator consumption are negligible, counter each other out and are well within the margin of error so these are not included to simplify the characterization.⁴⁶⁹

$$\Delta kWh_{PUMP} = HP * HP_{CONVERSION} * Hours * \%water_savings$$

Where:

⁴⁶⁶ Aligned with other national energy efficiency programs and confirmed with national vendors

⁴⁶⁷ Average cost per unit of capacity for laundromats was generated using data collected from previous Peoples Gas and North Shore Gas custom projects

⁴⁶⁸ Average costs per unit of capacity were generated using data collected from existing ozone laundry projects that received incentives under the Non-Residential Retrofit Demand Reduction program (NRR-DR), as well as from the Nicor Custom Incentive Program, and the Nicor Emerging Technology Program (ETP). See referenced document Table 2 and RSMMeans Mechanical Cost Data, 31st Annual Edition (2008)

⁴⁶⁹ Washer savings were reviewed but were considered negligible and not included in the algorithm (0.00082 kWh / lbs-capacity, determined through site analysis through Nicor Emerging Technology Program (ETP) and confirmed with national vendors). Note that washer savings from Nicor’s site analysis are smaller than those reported in a WI Focus on Energy case study (0.23kWh/100lbs, Hampton Inn Brookfield, November 2010). Electric impact of operating ozone generator (0.0021 kWh / lbs-capacity same source as washer savings) was also considered negligible and not included in calculations. Values should continue to be studied and monitored through additional studies due to limited data points used for this determination.

- ΔkWh_{PUMP} = Electric savings from reduced pumping load
- HP = Brake horsepower of boiler feed water pump;
= Actual, or use 5 HP if unknown⁴⁷⁰
- HP_{CONVERSION} = Conversion from Horsepower to Kilowatt
= 0.746
- Hours = Actual associated boiler feed water pump hours
= Must be a custom calculation for laundromats, but 800 hours can be used for other applications if unknown⁴⁷¹
- %water_savings = water reduction factor: how much more efficient an ozone injection washing machine is compared to a typical conventional washing machine as a rate of hot and cold water reduction.

Application	%water_savings
Laundromat	10% ⁴⁷²
Hotel/Motel	25% ⁴⁷³
Fitness and Recreation	
Healthcare	
Assisted Living	

Using defaults above:

$$\Delta kWh_{PUMP_LAUNDROMAT} = 5 * 0.746 * \text{Hours} * 0.10$$

$$= 0.373 \text{ kWh} * \text{Hours}$$

$$\Delta kWh_{PUMP_ALL\ OTHER} = 5 * 0.746 * 800 * 0.25$$

$$= 746 \text{ kWh}$$

Default per pound: = $\Delta kWh_{PUMP} / \text{Lbs-Capacity}$

Where:

Lbs-Capacity = Total washer capacity measured in pounds of laundry

Application	Lbs-Capacity
Laundromat	Actual combined capacity of ozone connected washers 254.38 lbs per site ⁴⁷⁴
Hotel/Motel	
Fitness and Recreation	
Healthcare	

⁴⁷⁰ Assumed average horsepower for boilers connected to applicable washer.

⁴⁷¹ Engineered estimate provided by CLEAResult review of Nicor custom projects. Machines spent approximately 7 minutes per hour filling with water and were in operation approximately 20 hours per day. Total pump time therefore estimated as $7/60 * 20 * 365 = 852$ hours, and rounded down conservatively to 800 hours.

⁴⁷² Page 7, Laundries and Dry-Cleaning Operations, Watersmart Guidebook EBMUD_WaterSmart_Guide_Laundries_Dry-Cleaning_Operations.pdf.

⁴⁷³ Average water reduction factors were generated using data collected from existing ozone laundry projects that received incentives under the Non-Residential Retrofit Demand Reduction program (NRR-DR). Table 6 summarizes data gathered from several NRR-DR projects, Nicor Custom projects, and Nicor ETP projects. Nicor Savings Numbers are associated with ACEE_AWE_Ozone Laundry / From Gas Savings Calculations.

⁴⁷⁴ Average lbs-capacity per project site was generated using data collected from existing ozone laundry projects that received incentives under the Non-Residential Retrofit Demand Reduction program (NRR-DR), as well as from the Nicor Custom Incentive Program, and the Nicor Emerging Technology Program (ETP). See referenced document Table 2.

Application	Lbs-Capacity
Assisted Living	

$$\Delta kWh_{PUMP\ ALL\ OTHERS} \text{ per pound} = 746/254.38$$

$$= 2.93 \text{ kWh/lb}$$

Secondary kWh Savings for Water Supply and Wastewater Treatment

The following savings should be included in the total savings for this measure, but should not be included in TRC tests to avoid double counting the economic benefit of water savings.

$$\Delta kWh_{water} = \Delta Water \text{ (gallons)} / 1,000,000 * E_{water\ total}$$

Where:

$$\Delta Water \text{ (gallons)}_{LAUNDROMAT} = 239 * Lbs_Capacity^{475}$$

$$\Delta Water \text{ (gallons)}_{ALL\ OTHERS} = 464,946^{476}$$

$$E_{water\ total} = \text{IL Total Water Energy Factor (kWh/Million Gallons)}$$

$$= 5,010^{477}$$

Deemed savings using defaults:

$$\Delta kWh_{water_LAUNDROMAT} = (239 * Lbs-Cpacity)/1,000,000 * 5,010$$

$$\Delta kWh_{water_ALL\ OTHERS} = 464,946/1,000,000 * 5,010$$

$$= 2,329 \text{ kWh}$$

SUMMER COINCIDENT PEAK DEMAND SAVINGS

Past project documentation and data collection is not sufficient to determine summer coincident peak demand savings for this measure. Value should continue to be studied and monitored through additional studies due to limited data points used for this determination. In absence of site-specific data, the summer coincident peak demand savings should be assumed to be zero.

$$\Delta kW = 0$$

FOSSIL FUEL SAVINGS

$$\Delta Therm = Therm_{Baseline} * \%hot_water_savings$$

Where:

$$\Delta Therm = \text{Gas savings resulting from a reduction in hot water use, in therm.}$$

$$Therm_{Baseline} = \text{Annual Baseline Gas Consumption}$$

$$= WHE * WUtiliz * WUsage_hot$$

Where:

$$WHE = \text{water heating energy: energy required to heat the hot water used}$$

⁴⁷⁵ See the “Water Impact Descriptions and Calculation” section of this measure for more information.

⁴⁷⁶ See the “Water Impact Descriptions and Calculation” section of this measure for more information.

⁴⁷⁷ This factor include 2571 kWh/MG for water supply based on Illinois energy intensity data from a 2012 ISAWWA study and 2439 kWh/MG for wastewater treatment based on national energy intensity use estimates. For more information please review Elevate Energy’s ‘IL TRM: Energy per Gallon Factor, May 2018 paper’.

$$= 0.00885 \text{ therm/gallon}^{478}$$

WUtiliz = washer utilization factor: the annual pounds of clothes washed per year
 = actual, if unknown the values below:

Application	WUtiliz
Laundromat	2,190 ⁴⁷⁹ cycles per year * Lbs-Capacity
Hotel/Motel	916,150 lbs ⁴⁸⁰ (Approx. 4,745 cycles per year) per site
Fitness and Recreation	
Healthcare	
Assisted Living	

WUsage_hot = hot water usage factor: how much hot water a typical conventional washing machine utilizes, normalized per pounds of clothes washed

Application	WUsage_hot
Laundromat	0.64 gallons/lb ⁴⁸¹
Hotel/Motel	1.19 gallons/lb ⁴⁸²
Fitness and Recreation	
Healthcare	
Assisted Living	

Using defaults above:

$$\begin{aligned} \text{Therm}_{\text{Baseline_LAUNDROMAT}} &= 0.00885 * (2,190 \text{ cycles per year} * \text{Lbs-Capacity}) * 0.64 \\ &= 12.4 \text{ therms} * \text{Lbs-Capacity} \end{aligned}$$

$$\begin{aligned} \text{Therm}_{\text{Baseline_ALL OTHERS}} &= 0.00885 * 916,150 * 1.19 \\ &= 9648 \text{ therms} \end{aligned}$$

%hot_water_savings = hot water reduction factor: how much more efficient an ozone injection washing machine is, compared to a typical conventional washing machine, as a rate of hot water reduction

Application	%hot_water_savings
Laundromat	100%
Hotel/Motel	81% ⁴⁸³
Fitness and Recreation	
Healthcare	

⁴⁷⁸ Assuming boiler efficiency is the regulated minimum efficiency (80%), per Title 20 Appliance Standard of the California Energy Regulations (October 2007). The incoming municipal water temperature is assumed to be 55°F with an average hot water supply temperature of 140°F, based on default test procedures on clothes washers set by the Department of Energy’s Office of Energy Efficiency and Renewable Energy (Federal Register, Vol. 52, No. 166). Enthalpies for these temperatures (107 btu/lbs at 140°F, 23.07 btu/lbs at 55°F) were obtained from ASHRAE Fundamentals.

⁴⁷⁹ DOE Technical Support Document Chapter 6, 2010 <https://www.regulations.gov/contentStreamer?documentId=EERE-2006-STD-0127-0118&attachmentNumber=8&disposition=attachment&contentType=pdf>

⁴⁸⁰ Average utilization factors were generated using data collected from existing ozone laundry projects that received incentives under the NRR-DR program. Table 3 summarizes data gathered from several NRR-DR projects, Nicor Custom projects, and Nicor ETP projects.

⁴⁸¹ Calculated as WUsage * Average % Hot water (estimated at 59% from Custom laundromat data); 1.09*0.59 = 0.64 gal / lbs laundry.

⁴⁸² Average hot water usage factors were generated using data collected from existing ozone laundry projects that received incentives under the NRR-DR program. Summarizes data gathered from several NRR-DR projects.

⁴⁸³ Average hot water reduction factors were generated using data collected from existing ozone laundry projects that received incentives under the Non-Residential Retrofit Demand Reduction program (NRR-DR). Table 5 summarizes data gathered from several NRR-DR projects, Nicor Custom projects, and Nicor ETP projects. Nicor Savings Numbers are associated with ACEE_AWE_Ozone Laundry / From Gas Savings Calculations.

Application	%hot_water_savings
Assisted Living	

Savings using defaults above:

$$\begin{aligned} \Delta\text{Therm} &= \text{Therm}_{\text{Baseline}} * \% \text{hot_water_savings} \\ \Delta\text{Therm}_{\text{LAUNDROMAT}} &= 12.4 * \text{Lbs-Capacity} * 100\% \\ &= 12.4 \text{ therms} * \text{Lbs-Capacity} \\ \Delta\text{Therm}_{\text{ALL OTHER}} &= 9648 * 81\% \\ &= 7815 \text{ therms per site} \end{aligned}$$

Default per lb capacity:

$$\begin{aligned} \Delta\text{Therm}_{\text{LAUNDROMAT}} / \text{lb} &= 12.4 * \text{Lbs-Capacity} / \text{lb capacity} \\ &= 12.4 \text{ therms} / \text{lb} \\ \Delta\text{Therm}_{\text{ALL OTHER}} / \text{lb} &= 7815 / 254.38 \\ &= 30.7 \text{ therms} / \text{lb} \end{aligned}$$

WATER IMPACT DESCRIPTIONS AND CALCULATION

The water savings calculations listed here account for the combination of hot and cold water used. Savings calculations for this measure were based on the reduction in total water use from implementing an ozone washing system to the base case. There are three main components in obtaining this value:

$$\Delta\text{Water (gallons)} = \text{WUsage} * \text{WUtiliz} * \% \text{water_savings}$$

Where:

$\Delta\text{Water (gallons)}$ = reduction in total water use from implementing an ozone washing system to the base case

WUsage = water usage factor: amount of total water used by a conventional washing machine normalized per unit of clothes washed

$$\text{WUsage}_{\text{LAUNDROMATS}} = 1.09 \text{ gallons} / \text{lbs laundry}^{484}$$

$$\text{WUsage}_{\text{ALL OTHERS}} = 2.03 \text{ gallons/lbs laundry}^{485}$$

WUtiliz = washer utilization factor: the annual pounds of clothes washed per year
= actual, if unknown use the values below:

Application	WUtiliz
Laundromat	2,190 ⁴⁸⁶ cycles per year * Lbs-Capacity
Hotel/Motel	916,150 lbs ⁴⁸⁷ (Approx. 4,745 cycles per year) per site
Fitness and Recreation	
Healthcare	

⁴⁸⁴ Based on Peoples Gas custom project data.

⁴⁸⁵ Average water usage factors were generated using data collected from existing ozone laundry projects that received incentives under the NRR-DR program. summarizes data gathered from several NRR-DR projects.

⁴⁸⁶ DOE Technical Support Document Chapter 6, 2010 <https://www.regulations.gov/contentStreamer?documentId=EERE-2006-STD-0127-0118&attachmentNumber=8&disposition=attachment&contentType=pdf>

⁴⁸⁷ Average utilization factors were generated using data collected from existing ozone laundry projects that received incentives under the NRR-DR program. Table 3 summarizes data gathered from several NRR-DR projects, Nicor Custom projects, and Nicor ETP projects.

Application	WUtiliz
Assisted Living	

%water_savings = water reduction factor: how much more efficient an ozone injection washing machine is compared to a typical conventional washing machine as a rate of hot and cold water reduction.

Application	%water_savings
Laundromat	10% ⁴⁸⁸
Hotel/Motel	25% ⁴⁸⁹
Fitness and Recreation	
Healthcare	
Assisted Living	

Savings using defaults above:

$$\begin{aligned} \Delta\text{Water} &= \text{WUsage} * \text{WUtiliz} * \% \text{water_savings} \\ \Delta\text{Water}_{\text{LAUNDROMATS}} &= 1.09 * \text{WUtiliz} * 0.1 \\ &= 1.09 * (2,190 * \text{Lbs-Capacity}) * 0.1 \\ &= 239 * \text{Lbs-Capacity} \\ \Delta\text{Water}_{\text{ALL OTHERS}} &= 2.03 * 916,150 * 0.25 \\ &= 464,946 \text{ gallons per site} \end{aligned}$$

Default per pound:

$$\begin{aligned} \Delta\text{Water}_{\text{LAUNDROMATS}} / \text{lb capacity} &= (239 * \text{Lbs-Capacity}) / \text{lb-capacity} \\ &= 239 \text{ gallons/lb} \\ \Delta \text{Water}_{\text{ALL OTHERS}} / \text{lb-capacity} &= 464,946 / 254.38 \\ &= 1,828 \text{ gallons / lb} \end{aligned}$$

DEEMED O&M COST ADJUSTMENT CALCULATION

Maintenance is required for the following components annually:⁴⁹⁰

- Ozone Generator: filter replacement, check valve replacement, fuse replacement, reaction chamber inspection/cleaning, reaction chamber o-ring replacement
- Air Preparation – Heat Regenerative: replacement of two medias
- Air Preparation – Oxygen Concentrators: filter replacement, pressure relief valve replacement, compressor rebuild
- Venturi Injector: check valve replacement

Maintenance is expected to cost \$0.79 / lbs capacity.

⁴⁸⁸ Page 7, Laundries and Dry-Cleaning Operations, Watersmart Guidebook EBMUD_WaterSmart_Guide_Laundries_Dry-Cleaning_Operations.pdf.

⁴⁸⁹ Average water reduction factors were generated using data collected from existing ozone laundry projects that received incentives under the Non-Residential Retrofit Demand Reduction program (NRR-DR). Table 6 summarizes data gathered from several NRR-DR projects, Nicor Custom projects, and Nicor ETP projects. Nicor Savings Numbers are associated with ACEE_AWE_Ozone Laundry / From Gas Savings Calculations.

⁴⁹⁰ Confirmed through communications with national vendors and available references, via an online forum (The Ozone Laundry Blog – The Importance of Maintenance).

SOURCES

Source ID	Reference
1	"Lodging Report", December 2008, California Travel & Tourism Commission, http://tourism.visitcalifornia.com/media/uploads/files/editor/Research/CaliforniaTourism_200812.pdf
2	"Health, United States, 2008" Table 120, U.S. Department of Health & Human Services, Centers for Disease Control & Prevention, National Center for Health Statistics, http://www.cdc.gov/nchs/data/hus/hus08.pdf#120
3	Fourth Quarter 2008 Facts and Figures, California Department of Corrections & Rehabilitation (CDCR), http://www.cdcr.ca.gov/Divisions_Boards/Adult_Operations/docs/Fourth_Quarter_2008_Facts_and_Figures.pdf
4	Jail Profile Survey (2008), California Department of Corrections & Rehabilitation (CDCR), http://www.cdcr.ca.gov/Divisions_Boards/CSA/FSO/Docs/2008_4th_Qtr_JPS_full_report.pdf
5	DEER2011_NTGR_2012-05-16.xls from DEER Database for Energy-Efficient Resources; Version 2011 4.01 Under: DEER2011 Update Documentation linked at: DEER2011 Update Net-To-Gross table Cells: T56 and U56
6	The Benefits of Ozone in Hospitality On-Premise Laundry Operations, PG&E Emerging Technologies Program, Application Assessment Report #0802, April 2009.
7	Federal Register, Vol. 52, No. 166
8	2009 ASHRAE Handbook – Fundamentals, Thermodynamic Properties of Water at Saturation, Section 1.1 (Table 3), 2009
9	Table 2 through 6: Excel file summarizing data collected from existing ozone laundry projects that received incentives under the NRR-DR program
10	DOE Technical Support Document Chapter 6, 2010 https://www.regulations.gov/contentStreamer?documentId=EERE-2006-STD-0127-0118&attachmentNumber=8&disposition=attachment&contentType=pdf
11	GTI Residential Ozone Laundry Field Demonstration (May 2018)

MEASURE CODE: CI-HWE-OZLD-V07-230101

REVIEW DEADLINE: 1/1/2026

4.3.7 Multifamily Central Domestic Hot Water Plants

DESCRIPTION

This measure covers multifamily central domestic hot water (DHW) plants with thermal efficiencies greater than or equal to 88%. This measure is applicable to any combination of boilers and storage tanks provided the thermal efficiency of the boiler(s) is greater than 88%. Plants providing other than solely DHW are not applicable to this measure.

This measure was developed to be applicable to the following program types: TOS, NC, ER.

If applied to other program types, the measure savings should be verified.

Note, IECC 2021 has become effective statewide as of January 1, 2024. IECC 2018 is the requisite code for any projects with permitting dates spanning July 1, 2019 to 12/31/2023. As code requirements and adoption can differ from municipality to municipality, the user should always verify which version of code is applicable.

DEFINITION OF EFFICIENT EQUIPMENT

To qualify, the boiler(s) must have a Thermal Efficiency of 88% or greater and supply domestic hot water to multi-family buildings.

DEFINITION OF BASELINE EQUIPMENT

For TOS, the baseline boiler is assumed to have a Thermal Efficiency of 80%.⁴⁹¹

For Early Replacement, the savings are calculated between existing unit and efficient unit consumption during the remaining life of the existing unit, and between new baseline unit as above and efficient unit consumption for the remainder of the measure life.

DEEMED LIFETIME OF EFFICIENT EQUIPMENT

The measure life for the domestic hot water boilers is 15 years.⁴⁹²

DEEMED MEASURE COST

TOS: The actual install cost should be used for the efficient case, minus the baseline cost assumption provided below:

Capacity Range	Baseline Installed Cost per kBtuh ⁴⁹³
< 300 kBtuh	\$65 per kBtuh
300 – 2500 kBtuh	\$38 per kBtuh
> 2500 kBtuh	\$32 per kBtuh

LOADSHAPE

N/A

COINCIDENCE FACTOR

N/A

⁴⁹¹ International Energy Conservation Code (IECC) 2012/2015/2018/2021, Table C404.2, Minimum Performance of Water-Heating Equipment, hot water supply boiler, gas.

⁴⁹² Nicor Gas Energy Efficiency Plan 2011-2014. Revised Plan Filed Pursuant to Order Docket 10-0562, May 27, 2011.

⁴⁹³ Baseline install costs are based on data from the “2010-2012 WO017 Ex Ante Measure Cost Study”, Itron, California Public Utilities Commission. The data is provided in a file named “MCS Results Matrix – Volume I”.

Algorithm

CALCULATION OF ENERGY SAVINGS

ELECTRIC ENERGY SAVINGS

There are no anticipated electrical savings from this measure.

SUMMER COINCIDENT PEAK DEMAND SAVINGS

N/A

FOSSIL FUEL SAVINGS

Time of Sale:

$$\Delta\text{Therms} = \text{Hot Water Savings} + \text{Standby Loss Savings}$$

$$= \left[\frac{(\text{MFHH} * \#\text{Units} * \text{GPD} * \text{Days/yr} * \gamma_{\text{Water}} * (T_{\text{out}} - T_{\text{in}}) * (1/\text{Eff}_{\text{base}} - 1/\text{Eff}_{\text{ee}}))}{100,000} \right] + \left[\frac{(\text{SL} * \text{Hours/yr} * (1/\text{Eff}_{\text{base}} - 1/\text{Eff}_{\text{ee}}))}{100,000} \right]$$

Early Replacment:⁴⁹⁴

$$\Delta\text{Therms for remaining life of existing unit (first 5 years):}$$

$$= \left[\frac{(\text{MFHH} * \#\text{Units} * \text{GPD} * \text{Days/yr} * \gamma_{\text{Water}} * (T_{\text{out}} - T_{\text{in}}) * (1/\text{Eff}_{\text{exist}} - 1/\text{Eff}_{\text{ee}}))}{100,000} \right] + \left[\frac{(\text{SL} * \text{Hours/yr} * (1/\text{Eff}_{\text{exist}} - 1/\text{Eff}_{\text{ee}}))}{100,000} \right]$$

$$\Delta\text{Therms for remaining measure life (next 10 years):}$$

$$= \left[\frac{(\text{MFHH} * \#\text{Units} * \text{GPD} * \text{Days/yr} * \gamma_{\text{Water}} * (T_{\text{out}} - T_{\text{in}}) * (1/\text{Eff}_{\text{base}} - 1/\text{Eff}_{\text{ee}}))}{100,000} \right] + \left[\frac{(\text{SL} * \text{Hours/yr} * (1/\text{Eff}_{\text{base}} - 1/\text{Eff}_{\text{ee}}))}{100,000} \right]$$

Where:

MFHH = number of people in multifamily household

Household Unit Type	Household ⁴⁹⁵		
	IQ Participants	Non-IQ Participants	All Participants
Multifamily - Deemed	2.3	2.09	2.18
Custom	Actual Occupancy or Number of Bedrooms ⁴⁹⁶		

#Units = Number of units served by hot water boiler
= Actual

GPD = Gallons of hot water used per person per day
= Actual. If unknown assume 17.6 gallons per person per day⁴⁹⁷

⁴⁹⁴ The two equations are provided to show how savings are determined during the initial phase of the measure (existing to efficient) and the remaining phase (new baseline to efficient). In practice, the screening tools used may either require a First Year savings (using the first equation) and then a “number of years to adjustment” and “savings adjustment” input which would be the (new base to efficient savings)/(existing to efficient savings).

⁴⁹⁵ Assumptions are taken from the draft unadjusted 2024 Baseline Study evaluation data provided in 07/2024 by GDS Associates.

⁴⁹⁶ Bedrooms are suitable proxies for household occupancy, and may be preferable to actual occupancy due to turnover rates in residency and non-adult population impacts.

⁴⁹⁷ Deoreo, B., and P. Mayer. Residential End Uses of Water Study Update. Forthcoming. ©2015 Water Research Foundation. Reprinted With Permission.

Days/yr	= 365.25
γ_{Water}	= Specific Weight of Water = 8.33 gal/lb
T_{out}	= tank temperature of hot water = 125°F or custom
T_{in}	= Incoming water temperature from well or municipal system = 50.7°F ⁴⁹⁸
Eff_{base}	= thermal efficiency of base unit = 80% ⁴⁹⁹
Eff_{ee}	= thermal efficiency of efficient unit complying with this measure = Actual. If unknown assume 88%
$\text{Eff}_{\text{exist}}$	= thermal efficiency of existing unit = Actual. If unknown assume 73% ⁵⁰⁰
SL	= Standby Loss ⁵⁰¹ = (Input rating / 800) + (110 * $\sqrt{\text{Tank Volume}}$).
	Input rating = Name plate input capacity in btuh
	Tank Volume = Rated volume of the tank in gallons
Hours/yr	= 8766 hours
100,000	= btu/therm

⁴⁹⁸ Table 4 in Chen, et. al., “Calculating Average Hot Water Mixes of Residential Plumbing Fixtures”, June 2020, reports a value of 50.7°F for inlet water temperature for U.S. Census Division 3.

⁴⁹⁹ IECC 2021, Table C404.2, Minimum Performance of Water-Heating Equipment, hot water supply boiler, gas.

⁵⁰⁰ Based upon DCEO data provided 10/2014; average age adjusted efficiency of existing units replaced through the program. Efficiency age adjustment of 0.5% per year based upon NREL “Building America Performance Analysis Procedures for Existing Homes”.

⁵⁰¹ Stand-by loss is provided in IECC 2012/2015/2018, Table C404.2, Minimum Performance of Water-Heating Equipment.

Time of Sale:

For example, an 88% 1000-gallon boiler with 150,000 btuh input rating installed serving 50 units with average 2.1 people per unit.

$$\begin{aligned} \Delta\text{Therms} &= \text{Hot Water Savings} + \text{Standby Loss Savings} \\ &= [(MFHH * \#Units * GPD * Days/yr * \gamma_{\text{Water}} * (T_{\text{out}} - T_{\text{in}}) * (1/\text{Eff}_{\text{base}} - 1/\text{Eff}_{\text{ee}})) / 100,000] \\ &\quad + [(SL * Hours/yr * (1/\text{Eff}_{\text{base}} - 1/\text{Eff}_{\text{ee}})) / 100,000] \\ &= [(2.1 * 50 * 17.6 * 8.33 * 365.25 * 1.0 * (125-50.7) * (1/0.8 - 1/0.88)) / 100,000] + \\ &\quad [((150,000/800 + (110 * \sqrt{1000}) * 8766 * (1/0.8 - 1/0.88)) / 100,000)] \\ &= 475 + 37 \\ &= 512 \text{ therms} \end{aligned}$$

Early Replacement:

For example, an 88% 1000-gallon boiler with 150,000 btuh input rating installed serving 50 units with average 2.1 people per unit replaces a working unit with unknown efficiency.

$$\begin{aligned} \Delta\text{Therms for remaining life of existing unit first 5 years):} \\ &= [(2.1 * 50 * 17.6 * 8.33 * 365.25 * 1.0 * (125-50.7) * (1/0.73 - 1/0.88)) / 100,000] + \\ &\quad [((150,000/800 + (110 * \sqrt{1000}) * 8766 * (1/0.73 - 1/0.88)) / 100,000)] \\ &= 975 + 75 \\ &= 1050 \text{ therms} \\ \Delta\text{Therms for remaining measure life (next 10 years):} \\ &= 475 + 37 \text{ (as above)} \\ &= 512 \text{ therms} \end{aligned}$$

WATER IMPACT DESCRIPTIONS AND CALCULATION

N/A

DEEMED O&M COST ADJUSTMENT CALCULATION

N/A

MEASURE CODE: CI-HWE-MDHW-V08-250101

REVIEW DEADLINE: 1/1/2029

4.3.8 Controls for Central Domestic Hot Water

DESCRIPTION

Demand control recirculation pumps seek to reduce inefficiency by combining control via temperature and demand inputs, whereby the controller will not activate the recirculation pump unless both (a) the recirculation loop return water has dropped below a prescribed temperature (e.g., 100°F) and (b) a CDHW demand is sensed as water flow through the CDHW system.

This measure was developed to be applicable to the following program types: TOS, RF, NC. If applied to other program types, the measure savings should be verified.

DEFINITION OF EFFICIENT EQUIPMENT

There are three efficient technologies to be considered:

- Timer-based: allows the user to program a schedule to perform recirculation during specific windows throughout the day.
- Aquastat-controlled: calls for recirculation when the water temperature at one point in the system falls below a certain pre-programmed setpoint (e.g., 100°F).
- On-Demand: senses the demand as water flow through the CDHW system. These types of system are most adequate on small central water heating systems.

DEFINITION OF BASELINE EQUIPMENT

The baseline for this measure category is existing, uncontrolled recirculation pumps on gas-fired CDHW system.

DEEMED LIFETIME OF EFFICIENT EQUIPMENT

The effective useful life is 15 years.⁵⁰²

DEEMED MEASURE COST

The average cost of the demand controller circulation kit is \$1,442 with an installation cost of \$768 for a total measure cost of \$2,210.⁵⁰³

LOADSHAPE

Loadshape C02 - Non-Residential Electric DHW

COINCIDENCE FACTOR

N/A

⁵⁰² Benningfield Group. (2009). *PY 2009 Monitoring Report: Demand Control for Multifamily Central Domestic Hot Water*. Folsom, CA: Prepared for Southern California Gas Company, October 30, 2009.

⁵⁰³ The incremental costs were averaged based on the following multi-family, dormitory and hospitality building studies-Gas Technology Institute. (2014). *1003: Demand-based domestic hot water recirculation Public project report*. Des Plaines, IL: Prepared for Nicor Gas, January 7, 2014.

Studies performed in multiple dormitory buildings in the California region for Southern California Gas' PREPS Program, 2012. Evaluation of New DHW System Controls in Hospitality and Commercial Buildings. Prepared for: Minnesota Department of Commerce, Division of Energy Resources, 2018.

Algorithm

CALCULATION OF ENERGY SAVINGS

ELECTRIC ENERGY SAVINGS

$$\Delta kWh = \Delta kWh_{heater} + \Delta kWh_{pump}$$

$$\Delta kWh_{heater} = \%ElecDHW * Boiler Capacity * (t_{normal\ occ} * R_{normal\ occ} + t_{low\ occ} * R_{low\ occ}) / 3,412$$

$$\Delta kWh_{pump} = (HP_{recirc} * 0.746 * (8760 - Pump_{hrs\ controlled}) / Motor_{eff}$$

$$\Delta kWh_{pump} = 1,103^{504} \text{ kWh as default value if values unknown.}$$

Where:

%ElecDHW = proportion of water heating supplied by electric resistance heating
 = 1 if electric DHW; 0 if fuel DHW. If unknown, assume 27.6%.⁵⁰⁵

Boiler Capacity = Input Capacity of the Domestic Hot Water boiler in BTU/hr. When paired with the installation of a new boiler, use the actual capacity of the new boiler.
 = If the facility uses the same boiler for space heat and domestic hot water, estimate the boiler input capacity for only domestic hot water loads. If this cannot be estimated, use the table below:

Building Type	% of Boiler Input Capacity	Or Use the Following Formulas
Multifamily	22.75% ⁵⁰⁶	= 12,493 BTU/hr * (#Apartments) ⁵⁰⁷
Dormitories	16.48% ⁵⁰⁸	= 4,938 BTU/hr * (#Rooms) ⁵⁰⁹
Hotels/Motels	12.33% ⁵¹⁰	= 3,696 BTU/hr * (#Rooms) ⁵¹¹
Offices	Use Actual Size	Use Actual Size

⁵⁰⁴ This value is the average kWh saved per pump based on results from Multi-Family buildings studied in Nicor Gas Emerging Technology Program study, Southern California Gas’ study in multiple dormitory buildings, and Minnesota’s Evaluation of New DHW System Controls in Hospitality and Commercial Buildings. Note this value does not reflect savings from electric units but electrical savings from gas-fired units. See ‘CDHW Controls Summary Calculations.xlsx’ for more information.

⁵⁰⁵ Based on Applied Energy Group, 2016 ‘Ameren Illinois Demand Side Management Market Potential Study: Volume 4 – APPENDICES’.

⁵⁰⁶ This is an average number based on Residential Energy Consumption Survey (2009) data and Commercial Building Energy Consumption Survey (2012) data compiled by U.S. Energy Information Administration, for buildings with more than 5 apartments in Illinois and Nursing Home and Assisted Living facilities in Midwest.

⁵⁰⁷ This is based on studies done in multiple university dormitory buildings in the California region, for Southern California Gas’ PREPS Program, 2012. It closely matches the design guidelines outlined in 2007 ASHRAE Handbook, Chapter 49: Service Water Heating, Table 7, and assumes 1 to 2 students per dorm room based on typical dorm room layouts. This source provides the source for dormitory assumptions of Boiler Input Capacity, $t_{low\ occ}$, $R_{normal\ occ}$ and $R_{low\ occ}$.

⁵⁰⁸ This is based on Commercial Building Energy Consumption Survey (2012) data compiled by U.S. Energy Information Administration, for Education facilities in East North Central.

⁵⁰⁹ This is based on studies done at Multi-Family Buildings for the Nicor Gas Emerging Technology Program by Gas Technology Institute. It closely matches the design guidelines outlined in 2007 ASHRAE Handbook, Chapter 49: Service Water Heating, Table 9, and assumes 2.1 persons per apartment as per ComEd PY3 Multi-Family Home Energy Savings Program Evaluation Report Final, May 16, 2012, by Navigant. This source provides the source for dormitory assumptions of Boiler Input Capacity, $t_{low\ occ}$, $R_{normal\ occ}$ and $R_{low\ occ}$.

⁵¹⁰ This value is ratioed upon the Btu per Dwelling per Hotel/Motel vs Dormitory building type assuming the same heating capacity requirements based upon the similarity between the building types.

⁵¹¹ Calculated based upon ASHRAE 2015 ASHRAE HVAC Applications Table 6 and IL TRM assumptions. See ‘CDHW Controls Summary Calculations.xlsx’ for more information

- HP_{recirculating} = the size of the recirculating pump in HP
- 0.746 = Conversion factor kW/HP
- 8760 = Hours of operation of uncontrolled recirculating pump
- Pump_{hrs controlled} = The table below corresponds to the control types for commercial buildings

Hours of Operation ⁵¹²	
Timer	6,570
Aquastat-Controlled	1,095
On Demand	122

- Motor_{eff} = The efficiency of the pump motor. Use actual or, if unknown, use the table below:

Motor HP	Efficiency
0.25	66.7%
0.33	70.6%
0.5	75.3%
0.75	79.6%
1.0	81.2%
1.5	84.8%
2.0	85.8%
3.0	87.2%

SUMMER COINCIDENT PEAK DEMAND SAVINGS

N/A

FOSSIL FUEL SAVINGS

Gas savings for this measure can be calculated by using site specific boiler size and boiler usage information or deemed values are provided based on number of rooms for Dormitories and number of apartments for multifamily buildings.⁵¹⁴

$$\Delta\text{Therms} = \%FossilDHW * \text{Boiler Input Capacity} * (t_{normal\ occ} * R_{normal\ occ} + t_{low\ occ} * R_{low\ occ}) / 100,000$$

Where:

- %FossilDHW = proportion of water heating supplied by fossil fuel heating.
= 0 if electric DHW; 1 if fuel DHW. If unknown, assume 72.4%⁵¹⁵.
- Boiler Input Capacity = Input capacity of the Domestic Hot Water boiler in BTU/hr.
= If the facility uses the same boiler for space heat and domestic hot water, estimate the boiler input capacity for only domestic hot water loads. If this cannot be estimated, use the following table:

⁵¹² The Hours of operation of recirculating pump for commercial buildings in general from Research and Analysis of the Benefits of Appliance Standards for Domestic Hot Water Circulator Pumps. Energy Solutions (October 2021)

⁵¹³ Blended efficiencies for small motors IECC 2021, Table C405.8(2), Table C405.8(3) and Table C405.8(3)

⁵¹⁴ See 'CDHW Controls Summary Calculations.xlsx' for more information.

⁵¹⁵ Table HC8.9. Water Heating in U.S. Homes in Midwest Region, Divisions, and States, 2009 (RECS).

Building Type	% of Boiler Input Capacity	Or Use the Following Formulas
Multifamily	22.75% ⁵¹⁶	= 12,493 BTU/hr * (#Apartments) ⁵¹⁷
Dormitories	16.48% ⁵¹⁸	= 4,938 BTU/hr * (#Rooms) ⁵¹⁹
Hotels/Motels	12.33% ⁵²⁰	= 3,696 BTU/hr * (#Rooms) ⁵²¹
Offices	Use Actual Size	Use Actual Size

- $t_{normal\ occ}$ = Total operating hours of domestic hot water burner when the facility has normal occupancy. If unknown, use the following table.
- $t_{low\ occ}$ = Total operating hours of domestic hot water burner, when the facility has low occupancy.⁵²² If unknown, use the following table.
- $R_{normal\ occ}$ = Reduction(%) in total operating hours of domestic hot water burner, due to installed central domestic hot water controls, during normal occupancy period. Values are set in the table below.
- $R_{low\ occ}$ = Reduction(%) in total operating hours of domestic hot water burner, due to installed central domestic hot water controls, during low occupancy period. Values are set in the table below.

⁵¹⁶ This is an average number based on Residential Energy Consumption Survey (2009) data and Commercial Building Energy Consumption Survey (2012) data compiled by U.S. Energy Information Administration, for buildings with more than 5 apartments in Illinois and Nursing Home and Assisted Living facilities in Midwest.

⁵¹⁷ This is based on studies done in multiple university dormitory buildings in the California region, for Southern California Gas' PREPS Program, 2012. It closely matches the design guidelines outlined in 2007 ASHRAE Handbook, Chapter 49: Service Water Heating, Table 7, and assumes 1 to 2 students per dorm room based on typical dorm room layouts. This source provides the source for dormitory assumptions of Boiler Input Capacity, $t_{low\ occ}$, $R_{normal\ occ}$ and $R_{low\ occ}$.

⁵¹⁸ This is based on Commercial Building Energy Consumption Survey (2012) data compiled by U.S. Energy Information Administration, for Education facilities in East North Central.

⁵¹⁹ This is based on studies done at Multi-Family Buildings for the Nicor Gas Emerging Technology Program by Gas Technology Institute. It closely matches the design guidelines outlined in 2007 ASHRAE Handbook, Chapter 49: Service Water Heating, Table 9, and assumes 2.1 persons per apartment as per ComEd PY3 Multi-Family Home Energy Savings Program Evaluation Report Final, May 16, 2012 by Navigant. This source provides the source for dormitory assumptions of Boiler Input Capacity, $t_{low\ occ}$, $R_{normal\ occ}$ and $R_{low\ occ}$.

⁵²⁰ This value is ratioed upon the Btu per Dwelling per Hotel/Motel vs Dormitory building type assuming the same heating capacity requirements based upon the similarity between the building types.

⁵²¹ Calculated based upon ASHRAE 2015 ASHRAE HVAC Applications Table 6 and IL TRM assumptions. See 'CDHW Controls Summary Calculations.xlsx' for more information

⁵²² Low occupancy periods for dormitory buildings can be assumed as vacation day or holiday occupancy.

Building Type	t _{normal occ} (hours)	t _{low occ} (hours)	R _{normal occ} (%)	R _{low occ} (%)
Multi-Family	2,089 ⁵²³	0	24.02%	0%
Dormitories	1,688 ⁵²⁴	520 ⁵²⁵	22.44%	44.57% ⁵²⁶
Hotels/Motels	2,428 ⁵²⁷	0	13.44% ⁵²⁸	0%
Offices	2,857 ⁵²⁹	1,231	22.90%	41.70%

Based on defaults above:

$$\begin{aligned} \Delta\text{Therms} &= 30.1 * \text{number of rooms (for dormitories)} \\ &= 62.7 * \text{number of apartments (for multifamily buildings)} \\ &= 12.06 * \text{number of rooms (hotels/motels)} \end{aligned}$$

For example, a dormitory building has a 400,000 BTU/hr boiler whose burner operates for an estimated 580 hours during vacation months and 1,300 hours during regular occupancy months. Savings from installing central domestic hot water controls in this building are:

$$\begin{aligned} \Delta\text{Therms} &= 400,000 \text{ BTU/hr} * (1,300 * 0.2244 + 580 * 0.4457) / 100,000 \\ &= 2,201 \text{ therms} \end{aligned}$$

WATER IMPACT DESCRIPTIONS AND CALCULATION

N/A

DEEMED O&M COST ADJUSTMENT CALCULATION

N/A

MEASURE CODE: CI-HWE-CDHW-V07-250101

REVIEW DEADLINE: 1/1/2027

⁵²³ Based on results of the studies done at Multi-Family Buildings for the Nicor Gas Emerging Technology Program: Gas Technology Institute. (2014). *1003: Demand-based domestic hot water recirculation Public project report*. Des Plaines, IL: Prepared for Nicor Gas, January 7, 2014.

⁵²⁴ Based on results of studies performed in multiple university dormitory buildings in the California region, for Southern California Gas’ PREPS Program, 2012.

⁵²⁵ Low occupancy periods for dormitory buildings can be assumed as vacation day or holiday occupancy.

⁵²⁶ Estimated from low occupancy hours

⁵²⁷ Calculated from the Btu per dwelling unit and average annual therm consumption for DHW for all Hospitality Buildings noted in “Evaluation of New DHW System Controls in Hospitality and Commercial Buildings”, MN Commerce Department Energy Resources, 06/30/2018.

⁵²⁸ Average Hospitality Savings, “Evaluation of New DHW System Controls in Hospitality and Commercial Buildings”, MN Commerce Department Energy Resources, 06/30/2018.

⁵²⁹ Based on the report, Energy Efficiency with Domestic Water Heating in Commercial Buildings, ACEEE Summer Study on Energy Efficiency in Buildings, 2010. Using the tables of results for Tuesday, Saturday and Sunday to estimate blended values for t_{normal occ}, t_{low occ}, R_{normal occ} and R_{low occ}.

4.3.9 Heat Recovery Grease Trap Filter

DESCRIPTION

A heat recovery grease trap filter combines grease filters and a heat exchanger to recover heat leaving kitchen hoods. As a direct replacement for conventional hood mounted filters in commercial kitchens, they are plumbed to the domestic hot water system to provide preheating energy to incoming water.

This measure was developed to be applicable to the following program types: NC and RF. If applied to other program types, the measure savings should be verified. For NC projects, this measure may be applicable if code requirements are otherwise satisfied.

DEFINITION OF EFFICIENT EQUIPMENT

Grease filters with heat exchangers carrying domestic hot water in kitchen exhaust air ducts.

DEFINITION OF BASELINE EQUIPMENT

Kitchen exhaust air duct with constant air flow and no heat recovery.⁵³⁰

DEEMED LIFETIME OF EFFICIENT EQUIPMENT

The expected measure life is assumed to be 15 years.⁵³¹

DEEMED MEASURE COST

Full installation costs, including plumbing materials, labor and any associated controls, should be used for screening purposes.

LOADSHAPE

Loadshape C01 - Commercial Electric Cooking

COINCIDENCE FACTOR

Summer Peak Coincidence Factor for measure is provided below for different building type:⁵³²

Location	CF
Fast Food Limited Menu	0.32
Fast Food Expanded Menu	0.41
Pizza	0.46
Full Service Limited Menu	0.51
Full Service Expanded Menu	0.36
Cafeteria	0.36
Unknown	0.40

⁵³⁰ Savings methodology factors are for a constant speed fan.

⁵³¹ Professional judgement, consistent with expected lifetime of kitchen demand ventilation controls and other kitchen equipment.

⁵³²Minnesota 2012 Technical Reference Manual, Electric Food Service_v03.2.xls

Algorithm

CALCULATION OF ENERGY SAVINGS

ELECTRIC ENERGY SAVINGS

For electric hot water heaters:

$$\Delta kWh = \frac{[(Meal/Day * HW/Meal * Days/Year) * lbs/gal * BTU/lb.^{\circ}F * (\Delta T/filter * Qty_Filter) * 0.000293]}{(\eta_{HeaterElec})}$$

Where:

- Meal/Day = Average number of meals served per day. If not directly available, see Table 1.
- HW/Meal = Hot water required per meal
= 3 gal/meal⁵³³
- Days/Year = Number of days kitchen operates per year. If not directly available, see Table 1.
- Lbs/gal = Density of water
= 8.3 lbs/gal
- BTU/lb.°F = Specific heat of water
= 1.0
- ΔT/filter = Temperature difference of domestic water across each filter
= 5.8°F/filter⁵³⁴
- Qty_Filter = Number of heat recovery grease trap filters installed. If not directly available, see Table 1.

Commercial Kitchen Load based on Building Type

Building Type	Meals/Day ⁵³⁵	Assumed days/Year	Number of Filters ⁵³⁶
Primary School	400	312	2
Secondary School	600	312	3
Quick Service Restaurant	800	312	5
Full Service Restaurant	780	312	4
Large Hotel	780	356	4
Hospital	800	356	4

- η_{HeaterElec} = Efficiency of the Electric water heater.
= Actual. If unknown, for retrofit use the table C404.2 in IECC 2012. For new construction use the active code at time the permit was issued.

⁵³³ Average dishwashing and faucet water usage taken from Chapter 8, Table 8.3.3 Normalized Annual End Uses of Water in Select Restaurants in Western United States.

⁵³⁴ Average value based on case studies. Northwinds Sailing, Inc. and North Shore Sustainable Energy, LLC. *Angry Trout Café Kitchen Exhaust Heat Recovery*. Minnesota Department of Commerce, Division of Energy Resources, 2012.

⁵³⁵ Commercial Kitchen Loads for listed buildings in U.S. Department of Energy Commercial Reference Building Models of the National Building Stock, NREL

⁵³⁶ Each filter is 20 X 20 inches.

SUMMER COINCIDENT PEAK DEMAND SAVINGS

$$\Delta kW = \Delta kWh/Hours * CF$$

Where:

Hours = Hours of operation of kitchen exhaust air fan. If not directly available use:

Building Type	Kitchen Exhaust Fan Annual Operating Hours ⁵³⁷
Primary School	4,056
Secondary School	4,056
Quick Service Restaurant	5,616
Full Service Restaurant	5,616
Large Hotel	5,340
Hospital	3,916

CF = Summer Peak Coincidence Factor for measure:⁵³⁸

Location	CF
Fast Food Limited Menu	0.32
Fast Food Expanded Menu	0.41
Pizza	0.46
Full Service Limited Menu	0.51
Full Service Expanded Menu	0.36
Cafeteria	0.36
Unknown	0.40

FOSSIL FUEL SAVINGS

For natural gas hot water heaters:

$$\Delta Therm = [(Meal/Day * HW/Meal * Days/Year) * lbs/gal * BTU/lb .°F * (\Delta T/filter * Qty_Filter)] / (\eta_{HeaterGas} * 100,000)$$

Where:

$\eta_{HeaterGas}$ = Efficiency of the Gas water heater. If not directly available, use:
 = Actual. If unknown, for retrofit use the table C404.2 in IECC 2012. For new construction use the active code at time the permit was issued.

Other variables as above.

WATER AND OTHER NON-ENERGY IMPACT DESCRIPTIONS AND CALCULATION

N/A

⁵³⁷ Exhaust Fan Schedules for listed buildings in U.S. Department of Energy Commercial Reference Building Models of the National Building Stock, NREL.

⁵³⁸ Minnesota 2012 Technical Reference Manual, Electric Food Service_v03.2.xls.

DEEMED O&M COST ADJUSTMENT CALCULATION

O&M savings may result from reduced filter and hood cleaning frequencies. More research should be done to understand any potential savings and the associated value.

MEASURE CODE: CI-HWE-GRTF-V04-240101

REVIEW DEADLINE: 1/1/2027

4.3.10 DHW Boiler and Water Heater Tune-up

DESCRIPTION

Domestic hot water (DHW) boilers and water heaters provide hot water for bathrooms, kitchens, tubs and other appliances. Several commercial and industrial facilities such as multi-family buildings, lodging and restaurants have a separate hot water boiler serving DHW loads. Unlike space heating boilers, DHW boilers operate year round, which means they have a greater need to be properly maintained and tuned up.

This measure calculates savings for tuning up a DHW boiler or water heater to improve its efficiency and reduce its consumption. A boiler or water heater tune-up involves cleaning/inspecting burners, burner nozzles and combustion chambers, adjusting air flow and burner gas input to reduce stack temperatures, and checking venting and safety controls. A pre- and post- tune up combustion efficiency ticket (from combustion analyzer) can be used to confirm the improvement in boiler efficiency.

Boilers that serve only a DHW load are eligible for this measure, as are all types of central gas water heaters (including gas storage and tankless water heaters) for multifamily properties.

This measure was developed to be applicable to the following program types: RF. If applied to other program types, the measure savings should be verified.

DEFINITION OF EFFICIENT EQUIPMENT

To qualify for this measure the facility must, as applicable, complete the tune-up requirements⁵³⁹ listed below, by approved technician:

- Measure combustion efficiency using an electronic flue gas analyzer
- Adjust airflow and reduce excessive stack temperatures
- Adjust burner and gas input, manual or motorized draft control
- Check for proper venting
- Complete visual inspection of system piping and insulation
- Check safety controls
- Check adequacy of combustion air intake
- Clean fireside surfaces.
- Inspect all refractory. Patch and wash coat as required.
- Inspect gaskets on front and rear doors and replace as necessary.
- Seal and close front and rear doors properly.
- Clean low and auxiliary low water cut-off controls, then re-install using new gaskets.
- Clean plugs in control piping.
- Remove all hand hole and man hole plates. Flush boiler or water heater with water to remove loose scale and sediment.
- Replace all hand hole and man hole plates with new gaskets.
- Open feedwater tank manway, inspect and clean as required. Replace manway plate with new gasket.
- Clean burner and burner pilot.
- Check pilot electrode and adjust or replace.
- Clean air damper and blower assembly.
- Clean motor starter contacts and check operation.
- Make necessary adjustments to burner for proper combustion.

⁵³⁹ Act on Energy Commercial Technical Reference Manual No. 2010-4, 9.2.2 Gas Boiler Tune-up.

- Perform all flame safeguard and safety trip checks.
- Check all hand hole plates and man hole plates for leaks at normal operating temperatures and pressures.
- Troubleshoot any boiler system or water heater problems as requested by on-site personnel

DEFINITION OF BASELINE EQUIPMENT

The baseline condition of this measure is a boiler or central water heater for a multifamily property that has not had a tune-up within the past 36 months.

DEEMED LIFETIME OF EFFICIENT EQUIPMENT

The life of this measure is 3 years.⁵⁴⁰

DEEMED MEASURE COST

The cost of this measure is \$0.83/MBtu/hr per tune-up.⁵⁴¹

LOADSHAPE

N/A

COINCIDENCE FACTOR

N/A

Algorithm

CALCULATION OF ENERGY SAVINGS

ELECTRIC ENERGY SAVINGS

N/A

SUMMER COINCIDENT PEAK DEMAND SAVINGS

N/A

FOSSIL FUEL SAVINGS

$$\Delta\text{Therms} = ((T_{\text{out}} - T_{\text{in}}) * \text{HotWaterUse}_{\text{Gallon}} * \gamma_{\text{water}} * 1 * (1/\text{Eff}_{\text{before}} - 1/\text{Eff}_{\text{after}}))/100,000$$

Where:

- T_{OUT} = Hot water storage tank temperature
= 125°F
- T_{IN} = Incoming water temperature from well or municipal system
= 50.7°F⁵⁴²
- $\text{HotWaterUse}_{\text{Gallon}}$ = Estimated annual hot water consumption (gallons)
= Actual if possible to provide reasonable custom estimate. If not, the following methods are provided to develop an estimate:⁵⁴³

⁵⁴⁰ Act on Energy Commercial Technical Reference Manual No. 2010-4, 9.2.2 Gas Boiler Tune-up.

⁵⁴¹ Work Paper – Tune up for Boilers serving Space Heating and Process Load by Resource Solutions Group, January 2012

⁵⁴² Table 4 in Chen, et. al., “Calculating Average Hot Water Mixes of Residential Plumbing Fixtures”, June 2020, reports a value of 50.7°F for inlet water temperature for U.S. Census Division 3.

⁵⁴³ Methodology based on Cadmus analysis. Annual hot water usage in gallons based on CBECS (2012) and RECS (2009) consumption data of East North Central (removed outliers of 1,000 kBtu/h or less) to calculate hot water usage. Annual hot

1. Consumption per usable storage tank capacity

$$= \text{Capacity} * \text{Consumption/cap}$$

Where:

Capacity = Usable capacity of hot water storage tank in gallons
 = Actual

Consumption/cap = Estimate of consumption per gallon of usable tank capacity, based on building type:

Building Type ⁵⁴⁴	Consumption/Cap
Convenience	528
Education	568
Grocery	528
Health	788
Large Office	511
Large Retail	528
Lodging	715
Other Commercial	341
Restaurant	622
Small Office	511
Small Retail	528
Warehouse	341
Nursing	672
Multi-Family	894

2. Consumption per unit area by building type

$$= (\text{Area}/1000) * \text{Consumption}/1,000 \text{ sq.ft.}$$

Where:

Area = Area in sq.ft that is served by DHW boiler or water heater
 = Actual

Consumption/1,000 sq.ft. = Estimate of DHW consumption per 1,000 sq.ft. based on building type:

Building Type	Consumption/1,000 sq.ft.
Convenience	4,594
Education	7,285
Grocery	697
Health	24,540
Large Office	1,818
Large Retail	1,354

water gallons per tank size gallons based on the tank sizing methodology found in ASHRAE 2011 HVAC Applications. Chapter 50 Service Water Heating. Demand assumptions (gallons per day) for each building type based on ASHRAE Chapter 50 and to LBNL White Paper. LBL-37398 Technology Data Characterizing Water Heating in Commercial Buildings: Application to End Use Forecasting. Assumes hot water heater efficiency of 80%.

⁵⁴⁴ According to CBECS 2012 “Lodging” buildings include Dormitories, Hotels, Motel or Inns and other Lodging and “Nursing” buildings include Assisted Living and Nursing Homes.

Building Type	Consumption/1,000 sq.ft.
Lodging	29,548
Other Commercial	3,941
Restaurant	44,439
Small Office	1,540
Small Retail	6,111
Warehouse	1,239
Nursing	30,503
Multi-Family	15,434

3. Consumption by number of people per household

$$= \text{GPD} * \text{Household} * 365.25$$

Where:

GPD = Gallons Per Day of hot water use per person
 = 45.5 gallons hot water per day per household / 2.59 people per household.⁵⁴⁵
 = 17.6

Household = Average number of people per household

Household Unit Type	Household ⁵⁴⁶		
	IQ Participants	Non-IQ Participants	All Participants
Multifamily - Deemed	2.3	2.09	2.18
Custom	Actual Occupancy or Number of Bedrooms ⁵⁴⁷		

Use Multifamily if: Building meets utility’s definition for multifamily

365.25 = Days per year, on average

γ_{water} = Specific weight capacity of water (lb/gal)
 = 8.33 lbs/gal

1 = Specific heat of water (Btu/lb.°F)

$\text{Eff}_{\text{before}}$ = Efficiency of the boiler or water heater before tune-up

$\text{Eff}_{\text{after}}$ = Efficiency of the boiler or water heater after tune-up

100,000 = Converts Btu to therms

Note: Contractors should select a mid-level firing rate that appropriately represents the average building operating condition over the course of the year and take readings at a consistent firing rate for pre and post tune-up.

⁵⁴⁵ Deoreo, B., and P. Mayer. Residential End Uses of Water Study Update. Forthcoming. ©2015 Water Research Foundation. Reprinted With Permission.

⁵⁴⁶ Assumptions are taken from the draft unadjusted 2024 Baseline Study evaluation data provided in 07/2024 by GDS Associates.

⁵⁴⁷ Bedrooms are suitable proxies for household occupancy, and may be preferable to actual occupancy due to turnover rates in residency and non-adult population impacts.

For example, tune up of a DHW Boiler heating a 100 gallon storage tank in a nursing home, measuring 80% AFUE prior to tune up and 82.2% AFUE after.

$$\begin{aligned}\Delta\text{Therms} &= ((T_{\text{out}} - T_{\text{in}}) * \text{HotWaterUseGallon} * \gamma_{\text{water}} * 1 * (1/\text{Eff}_{\text{before}} - 1/\text{Eff}_{\text{after}}))/100,000 \\ &= ((125 - 50.7) * (100 * 672) * 8.33 * 1 * (1/0.8 - 1/0.822))/100,000 \\ &= 13.9 \text{ therms}\end{aligned}$$

WATER AND OTHER NON-ENERGY IMPACT DESCRIPTIONS AND CALCULATION

N/A

DEEMED O&M COST ADJUSTMENT CALCULATION

N/A

MEASURE CODE: CI-HWE-DBTU-V03-250101

REVIEW DEADLINE: 1/1/2029

4.3.11 Tunnel Washers

DESCRIPTION

Laundry equipment can be found at a variety of facilities, including hospitals, hotels, health clubs, penitentiaries, and others. Typically, these facilities use conventional batch washing machines for laundering their linens, towels, napkins and tablecloths, and uniforms. The uniformity of the feedstocks makes them good candidates for conversion to a continuous-batch tunnel washing machine system, which ultimately utilizes less water and detergent than conventional systems. The water savings are ultimately based on a comparison of the water efficiencies between the baseline and efficient equipment (measured in gallons of water per pound of laundry).

DEFINITION OF EFFICIENT EQUIPMENT

A tunnel washing machine utilizes a porous Archimedes screw to move laundry and wash water in opposite (or counterflow) directions. The laundry travels in the upslope direction, while the wash water travels downslope through the holes in the Archimedes screw. The laundry gets progressively cleaner as it travels up the screw, while the wash water gets progressively dirtier as it travels down the screw. The screw can be programmed to intermittently change direction, to provide additional agitation. The mechanical action of the screw and travel path of the wash water through holes helps significantly with the cleaning action of the tunnel washer, allowing a reduction in the amount of detergent and rinse water required.

In contrast to the baseline equipment, the tunnel washer reuses the “rinse” water from the top section of the tunnel into the lower “wash” water sections, along with the gradual introduction of detergent. The continuous counterflow of laundry and wash water ultimately results in a more water-efficient system.

Tunnel washers also utilize automated PLC computer controls to constantly monitor water temperatures in each section of the tunnel and to automate the introduction of fresh water and detergent. The speed of the Archimedes screw can adjust for the varying dirt load of the laundry input. The computer system can typically collect performance data (gallons of water, pounds of detergent, pounds of laundry) over time to continuously evaluate system efficiency.

Tunnel washers can utilize either a hydraulic press extractor to “squeeze” water out of the linen or a more conventional centrifugal extractor that spins the linen to remove the water.

Tunnel washers can also reduce manhours required to process the laundry, as a staff is not required to manually load and unload each batch. The continuous feed of laundry in a tunnel washing machine system requires less labor and reduces the potential for injury from sticking hand and arms into a conventional washing machine drum.

Tunnel washers are quite large compared to conventional washers and require a significant footprint in the facility. In addition, they require approximately 12 feet of ceiling clearance above the top of the tunnel washer for proper installation.

DEFINITION OF BASELINE EQUIPMENT

A traditional batch washing machine has discrete washing and rinsing cycles, wherein the water gets completely drained at the end of each cycle.

Typical top-loading washing machines used in homes and laundromats use approximately 40 gallons of water per load. This equates to 20 gallons for the wash cycle and 20 gallons for the rinse cycle. Some facilities will even utilize a second rinse cycle. The vertical axis design requires enough water in the drum to suspend the fabric in the soapy water.

The next step up in efficiency is a front-loading (or horizontal axis) washing machines. They typically use 20 to 30 gallons of water per load. This equates to 10-15 gallons for the wash cycle and 10-15 gallons for the rinse cycle.

Larger horizontal-axis washing machines can consume up to 45 gallons of water per load, equating to 22 gallons for the wash cycle and 22 gallons for the rinse cycle.

DEEMED LIFETIME OF EFFICIENT EQUIPMENT

The life of this measure is assumed to be 15 years for a new tunnel washing machine.⁵⁴⁸

DEEMED MEASURE COST

The actual cost of the measure should be used.⁵⁴⁹

LOADSHAPE

N/A

COINCIDENCE FACTOR

N/A

Algorithm

CALCULATION OF ENERGY SAVINGS

Energy savings from conversion from conventional washing machines to tunnel washing machines are the result of reduced water consumption and reduced natural gas consumption from heating water. There are indirect electric energy savings from reduced potable water treatment and wastewater treatment.

ELECTRIC ENERGY SAVINGS

The electric energy savings are based indirectly on the reduced electricity usage attributed to the water savings from the tunnel washing machine. By applying an “Energy Factor”, the water savings (in gallons/year) can be converted to electricity savings (in kWh/year). This “Energy Factor” considers the electric energy requirements of water treatment plants and water distribution infrastructure, and wastewater treatment and distribution infrastructure.

The methodology for estimating water savings is as follows:

$$\Delta\text{Water} = [\text{BWME} - \text{TWME}] \times \text{PLD} \times \text{ADPY}$$

$\Delta\text{Water} =$ Total Water Savings (gallons/year)

$\text{BWME} =$ Baseline Washing Machine Efficiency (gal of water / lb. of laundry)

$\text{TWME} =$ Tunnel Washing Machine Efficiency (gal of water / lb. of laundry)

$\text{PLD} =$ Pounds of Laundry Per Day (lb. laundry/day)

$\text{ADPY} =$ Annual Days Per Year (days/year)

The values for BWME and TWME should be taken from actual equipment specifications or actual measurements (water flow meters and mechanical scales).

Typical values for TWME can be range from 0.75-1.0 gal. of water/lb. of laundry.⁵⁵⁰ Some equipment vendors have claimed TWME approaching 0.3-0.4 gal. of water/lb. of laundry.⁵⁵¹ For the purposes of this measure, a TWME value of 0.87 gal. of water/lb. of laundry will be used.

⁵⁴⁸ Table 8-18: Average Useful Lifetime of Commercial Washing Equipment, Energy Savings Potential and RD&D Opportunities for Commercial Building Appliances, Navigant Consulting, December 21, 2009.

⁵⁴⁹ One study found the average cost of tunnel washers to be \$1,100,000. Energy Savings Potential and RD&D Opportunities for Commercial Building Appliances, Navigant Consulting, December 21, 2009.

https://www1.eere.energy.gov/buildings/publications/pdfs/corporate/commercial_appliances_report_12-09.pdf

⁵⁵⁰ Matt Poe. “Efficient, Flexible Tunnel Washers: Tunnel washers have made leaps forward in technology, productivity in the past 10 years”, *American Laundry News*, 12/11/18. <<https://americanlaundrynews.com/articles/efficient-flexible-tunnel-washers>>

⁵⁵¹ Ibid.

Typical values for BWME can range from 1.8-3.0 gal. of water/lb. of laundry.⁵⁵² For the purposes of this measure, a BWME value of 2.03 gal. of water/lb. of laundry will be used.⁵⁵³

The PLD is specific to each individual facility. An occupied hotel room typically produces 11 pounds of laundry per day.⁵⁵⁴ An occupied hospital bed likely produces a similar amount of laundry load. The laundry loads of restaurants, health clubs, prisons, and other facilities need to be quantified using actual facility data.

The PLD can also be estimated from the Ozone Laundry Measure in the IL TRM, section 4.3.6. This measure gives a Washer Utilization Factor (Wutil) of 916,150 pounds/year of laundry for a typical facility.⁵⁵⁵ Assuming 365 days/year of laundry activity, this would give a PLD of 2,508 pounds of laundry per day.

The ADPY is often 365 days per year for facilities that never shut down, including hospitals, hotels, and prisons. Other facilities may have regular shutdown periods, so the ADPY value should be adjusted as necessary.

The electricity savings for this measure can be calculated by applying the energy factor to the ΔWater. This EF considers savings from both potable water treatment and wastewater treatment.

$$\Delta kWh_{water} = \Delta Water \text{ (gallons)} / 1,000,000 * E_{water \text{ total}}$$

Where

$$E_{water \text{ total}} = \text{IL Total Water Energy Factor (kWh/Million Gallons)} \\ = 5,010^{556}$$

For example, switching from conventional washing machine technology to tunnel washing machine technology, at a facility that processes the defined 916,150 pounds/year (Wutil) and is open every day of the year.

$$\Delta Water = [BWME - TWME] \times PLD \times ADPY \\ = [(2.03 - 0.87) \text{ gal. of water/lb. of laundry}] \times (916,150 \text{ lb. of laundry/year}) \\ = 1,062,734 \text{ gal. of water/year}$$

$$\Delta kWh_{water} = \Delta Water / 1,000,000 * E_{water \text{ total}} \\ = (1,062,734 \text{ gal. of water/year}) / 1,000,000 * 5,010 \text{ kWh/million gallons} \\ = 5,324 \text{ kWh/year}$$

SUMMER COINCIDENT PEAK DEMAND SAVINGS

Since the times of day from the water savings measure do not necessarily coincide with the times of day that the water treatment and distribution equipment is in use, the coincident peak demand savings cannot be determined.

FOSSIL FUEL SAVINGS

With reduced water use by the installation of a tunnel washer, the DHW boiler used to heat the incoming water will use significantly less gas. The below algorithm can be used to calculate natural gas savings for hot water heating.

⁵⁵² Theresa Boehl. "Tunnel Washers: The Answer to Rising Labor, Utility Costs?", *American Laundry News*, 5/27/14.

<<https://americanlaundrynews.com/articles/tunnel-washers>>

⁵⁵³ IL TRM Section 4.3.6 "Ozone Laundry"

⁵⁵⁴ Joseph Ricci. "Outsourced Hotel Laundries: The Value of Certification", *Lodging*, 3/28/17.

<<https://lodgingmagazine.com/outsourced-hotel-laundries-the-value-of-certification/>>

⁵⁵⁵ IL TRM Section 4.3.6 footnote for W_{util} , which states "Average utilization factors were generated using data collected from existing ozone laundry projects that received incentives under the NRR-DR program."

⁵⁵⁶ This factor include 2571 kWh/MG for water supply based on Illinois energy intensity data from a 2012 ISAWWA study and 2439 kWh/MG for wastewater treatment based on national energy intensity use estimates. For more information please review Elevate Energy's 'IL TRM: Energy per Gallon Factor, May 2018 paper'.

$$\Delta\text{Therms} = ((T_{\text{out}} - T_{\text{in}}) * \text{HotWaterReduction}_{\text{Gallon}} * \gamma_{\text{water}} * 1 * (1/\text{Eff}))/100,000$$

Where:

T_{OUT}	= Hot water storage tank temperature = 125°F
T_{IN}	= Incoming water temperature from well or municipal system = 50.7°F ⁵⁵⁷
$\text{HotWaterReduction}_{\text{Gallon}}$	= Estimated annual hot water reduction (gallons) = Actual custom estimate
γ_{water}	= Specific weight capacity of water (lb/gal) = 8.33 lbs/gal
1	= Specific heat of water (Btu/lb.°F)
Eff	= Efficiency of the boiler = Use actual efficiency, otherwise use 80% AFUE
100,000	= Converts Btu to therms

For example, a DHW Boiler with an efficiency of 80% AFUE heats a 100 gallon storage tank in a laundry facility using a tunnel washer. Use of the tunnel washer will save the original laundry site an estimated 1,062,734 gallons of water the below example savings:

$$\begin{aligned} \Delta\text{Therms} &= ((T_{\text{out}} - T_{\text{in}}) * \text{HotWaterUse}_{\text{Gallon}} * \gamma_{\text{water}} * 1 * (1/\text{Eff}))/100,000 \\ &= ((125 - 50.7) * 1,062,734 * 8.33 * 1 * (1/0.8))/100,000 \\ &= 8221.8 \text{ therms} \end{aligned}$$

WATER AND OTHER NON-ENERGY IMPACT DESCRIPTIONS AND CALCULATION

The water savings from the tunnel washing machines will help preserve water supplies, extend the life of water treatment and wastewater treatment plants. The reduction in detergent requirements will also have cost and environmental benefits.

DEEMED O&M COST ADJUSTMENT CALCULATION

Actual O&M cost adjustments should be used for this measure.⁵⁵⁸

MEASURE CODE: CI-HWE-TUWA-V03-250101

REVIEW DEADLINE: 1/1/2029

⁵⁵⁷ Table 4 in Chen, et. al., "Calculating Average Hot Water Mixes of Residential Plumbing Fixtures", June 2020, reports a value of 50.7°F for inlet water temperature for U.S. Census Division 3.

⁵⁵⁸ Annual repair & maintenance costs have been estimated at \$19,000 per unit. Energy Savings Potential and RD&D Opportunities for Commercial Building Appliances, Navigant Consulting, December 21, 2009. https://www1.eere.energy.gov/buildings/publications/pdfs/corporate/commercial_appliances_report_12-09.pdf

4.3.12 Tank Insulation

DESCRIPTION

This measure provides rebates for installation of 1” or 2” fiberglass, mineral fiber, or other types of insulation with similar properties to existing bare heated tanks for industrial and some commercial installations. Storage tanks can hold any heated material including, but not limited to, hot water, thermal oil, chemicals, and asphalt.

Default per square foot savings estimates are provided for both exposed indoor and outdoor storage tanks that are heated by heat transfer fluids including steam and thermal oil. Only systems heated with natural gas are eligible for this measure.

Indoor tanks require at least 1” of insulation and outdoor tanks must have at least 2 inches of insulation and include an all-weather protective jacket. New advanced insulating materials may be thinner and savings can be calculated with 3E Plus v4.1.⁵⁵⁹

This measure was developed to be applicable to the following program types: RF (Retrofit), DI (Direct Install). If applied to other program types, the measure savings should be verified.

DEFINITION OF EFFICIENT EQUIPMENT

The efficient case is installing tank insulation to an uninsulated, heated material storage tank. Indoor tanks must have at least 1 inch of insulation (R-value of 2.1) and outdoor tanks must have at least 2” of insulation (R-value of 4.2) and include an all-weather protective jacket.

DEFINITION OF BASELINE EQUIPMENT

The base case for savings estimates is a bare, steel tank. Other tank materials can be used to calculate savings with 3E Plus v4.1. Tanks are not required by mechanical codes to be insulated and are commonly found without any insulation.⁵⁶⁰

DEEMED LIFETIME OF EFFICIENT EQUIPMENT

The measure life is assumed to be 15 years.⁵⁶¹

INCREMENTAL MEASURE COST

The incremental cost for this measure is \$12/ft².⁵⁶²

LOADSHAPE

N/A

COINCIDENCE FACTOR

N/A

Algorithm

⁵⁵⁹ 3E Plus v4.1 is a heat loss calculation software provided by the NAIMA (North American Insulation Manufacturer Association).

⁵⁶⁰ ASHRAE Handbook – Fundamentals 2017 lists requirements for pipe and duct insulation but does not mention tank insulation.

⁵⁶¹ Based on the California Municipal Utilities Association Technical Reference Manual Third Edition measure 14.1.

⁵⁶² Based on RS Means Data Line Number 220719101162.

CALCULATION OF ENERGY SAVINGS

ELECTRIC ENERGY SAVINGS

N/A

SUMMER COINCIDENT PEAK DEMAND SAVINGS

N/A

FOSSIL FUEL SAVINGS

$$\Delta\text{Therms} = [\text{ESF}_b * A_b + \text{ESF}_e * A_e] * \text{Hours} * \text{LF} * \text{TRF} / (100,000 * \eta)$$

Where:

ESF_b = Energy savings factor from tank body defined as the difference in heat loss between an insulated condition and a bare condition as found in table below [Btu/hr/ft²]

A_b = Area of tank body [ft²]
= Actual

ESF_e = Energy savings factor from tank endcap(s) defined as the difference in heat loss between an insulated condition and a bare condition as found in table below [Btu/hr/ft²]

A_e = Area of endcap(s) [ft²]
= Combined area of endcaps if tank is oriented horizontally, separate areas if tank is oriented vertically or only one endcap is insulated
= Actual

Hours = Operating hours of heating system
= Actual

LF = Load factor of heating system
= Annual gas consumption / (Hours * Nameplate Heating Capacity)

TRF = Thermal Regain Factor for tank location and use, see table below. The Custom TRF option may be used on any tank location, including tank locations with deemed TRFs specifically listed in the table below, if supporting justification and calculations for the Custom TRF are provided.

May vary seasonally such as: TRF[summer] * summer hours + TRF[winter] * winter hours where TRF values reflecting summer and winter conditions are apportioned by the hours for those conditions. TRF may also be adjusted by building specific balance point temperature (BPT) and operating hours above and below that BPT.⁵⁶³

Tank Location	Assumed Regain	TRF, Thermal Regain Factor
Outdoor	0%	1.0
Indoor, conditioned, annual use (e.g. hot water or process loads), 55°F BPT	45%	0.55
Indoor, semi-conditioned, annual use, 55°F BPT	16%	0.84

⁵⁶³ Zimmerman, Cliff, Franklin Energy, "Thermal Regain Factor_4-30-14.docx", 2014. Based on climate zone 2. Note 'Location not specified – Commercial' assumes pipes provide DHW year round. 'Location not specified – Commercial' assumes semi-conditioned annual usage.

Tank Location	Assumed Regain	TRF, Thermal Regain Factor
Indoor, unconditioned spaces, (no heat transfer to conditioned space)	0%	1.0
Location not specified - Commercial	45%	0.55
Location not specified – Industrial	16%	0.84
Custom	Custom	1 – assumed regain

- 100,000 = Conversion factor from BTUs to Therms
- η = Efficiency of heating equipment used to heat tanks
= Actual, or if unknown assume 79%⁵⁶⁴

The following table shows conductivities and maximum temperature ratings of similar insulation materials. The average value was used with 3EPlus software to generate the Energy Savings Factors used in the savings algorithm.

Table 1: Insulation Types

Insulation Type	Conductivity (Btu.in/ hr.ft ² .°F @ 300°F)	Max Temp (°F)
Mineral Fiber Pipe and Tank Wrap	0.48	650
Mineral Fiber Board	0.44	850
Polyurethane	0.5	400
Average	0.47	

The tank surface temperature assumption depends on the system type. The following table should be used to select the appropriate Energy Savings Factor based on the fluid temperature:

Table 2: Heating Fluid Temperatures

System Type	Fluid Temperature Assumption (°F)
Low Pressure Steam (< 15 psi)	225
High Pressure Steam (> 60 psi)	315
Thermal Oil	425

The energy savings factors (ESF) were developed using the 3E Plus v4.1 software program, and are derived as the difference in heat loss per square foot of a bare tank and an insulated tank.⁵⁶⁵ The energy savings analysis is based on adding 1” (indoor) or 2” (outdoor) thick insulation around bare tanks. Outdoor conditions are assumed to be 48.6°F with a wind speed of 5.0 mph.⁵⁶⁶ The thermal conductivity of tank insulation varies by material and temperature rating; to obtain a typical value, a range of materials allowed for this measure was averaged. For insulation materials not in the table above, use 3E Plus v4.1 software to calculate ESF_b and ESF_e .

Energy Savings Factors [Btu/hr/ft²]

⁵⁶⁴ Minimum efficiency for steam boilers as set in IECC 2018 code C403.3.2.
⁵⁶⁵ Tank insulation calc_8-4-20.xlsx including tables obtained from 3E Plus v4.1 software.
⁵⁶⁶ DOE Weather Data, TMY3 (Typical Meteorological Year), developed by NREL for the average ambient temperature and wind speed for Aurora, IL. Adjusted to align with ASHRAE 24.4 Terrain Category 1 for Large city centers with densely populated, tall buildings (2017).

		Low Pressure Steam	High Pressure Steam	Thermal Oil
Vertical Tank - Body	Indoor	290.2	559.0	991.8
	Outdoor	373.4	666.0	1132.0
Horizontal Tank - Body	Indoor	290.2	559.0	991.8
	Outdoor	373.4	666.0	1132.0
Vertical Tank End - Top	Indoor	336.8	642.8	783.9
	Outdoor	426.3	756.2	1269.6
Vertical Tank End - Bottom	Indoor	189.8	380.0	712.1
	Outdoor	288.1	515.7	897.3
Horizontal Tank End	Indoor	290.2	559.0	991.8
	Outdoor	373.4	666.0	1132.0

For example, an outdoor, vertical, cylindrical tank with a radius of 5 ft and height of 15 ft heated by a thermal oil heating system that is insulated around the body and top of the tank would save (assuming 4380 hours of operation, 70% load factor, and 78% efficient thermal oil heater):

$$\Delta\text{Therms} = [\text{ESF}_b * A_b + \text{ESF}_e * A_e] * \text{Hours} * \text{LF} * \text{TRF} / (100,000 * \eta)$$

$$\text{ESF}_b = 1132.0 \text{ Btu/hr/ft}^2$$

$$A_b = 2 * \pi * r * h$$

$$= 471.2 \text{ ft}^2$$

$$\text{ESF}_e = 1269.6 \text{ Btu/hr/ft}^2$$

$$A_e = \pi * r^2$$

$$= 78.5 \text{ ft}^2$$

$$\text{Hours} = 4380$$

$$\text{LF} = 0.7$$

$$\text{TRF} = 1.0$$

$$\eta = 0.78$$

$$\Delta\text{Therms} = [1132.0 * 471.2 + 1269.6 * 78.5] * 4380 * 0.7 * 1 / (100,000 * 0.78)$$

$$= 24,884 \text{ therms}$$

WATER AND OTHER NON-ENERGY IMPACT DESCRIPTIONS AND CALCULATION

N/A

DEEMED O&M COST ADJUSTMENT CALCULATION

N/A

MEASURE CODE: CI-HWE-TKIN-V03-240101

REVIEW DEADLINE: 1/1/2029

4.3.13 Tankless Water Heater Array

DESCRIPTION

A Central Condensing Tankless Water Heater (CCTWH) array is a type of domestic hot water heating system formed by integrating multiple condensing tankless water heating units in a modular style to increase overall system capacity, turndown capability and to reduce standby energy losses. Hot water energy savings resulting from reduction in standby losses and improved system efficiency are detailed in this measure.

Traditional domestic water heaters for large commercial applications come in two basic designs: conventional tank type water heaters and boilers with external storage tanks. Both these systems produce large volumes of hot water even when there is no demand, resulting in significant standby energy losses. For facilities with peak domestic hot water loads, the water heating system will be sized and installed to meet peak hot water loads. These large systems will often have low turndown ratios and will result in lower efficiencies during lower hot water loads.

On the other hand, gas fired instantaneous or tankless water heaters are defined by code for federal regulations⁵⁶⁷ as water heaters which produce not less than 4,000 Btu/hr per gallon of storage. Multiple individual condensing gas fired tankless water heating units are integrated together with specific system controls to form a CCTWH array.

As a replacement to conventional central domestic hot water systems, CCTWH arrays primarily yield energy savings by minimizing standby heat losses and providing high turn-down ratios and there by maximizing the “condensing” efficiency of the water heating system. The temperature difference between supply water temperature and inlet water temperature of the water heater determines the efficiency if the water heater. The inlet/return water temperatures need to be lower to achieve higher efficiencies. Without a storage tank, CCTWH arrays have lower thermal mass and lower return water temperatures to achieve high condensing level efficiencies. Typical points of application of CCTWH array are building types with high peak water heating demands and high turn down ratios like Multifamily, Hotels/ Motels, Hospitals and Universities/ Schools.

This measure involves estimation of hot water energy savings for multiple varying building specific and system specific parameter inputs to estimate hot water usage and energy savings. An external spreadsheet calculator⁵⁶⁸ located at [link] has been developed which utilizes the following inputs to facilitate the estimation of the hot energy savings for this measure.

- Measure type (New construction NC or Time of sale TOS)
- Building type⁵⁶⁹
 - Application type: Multifamily, Hotels and Motels.
 - Number of units served by the water heater.
 - Application type: Hospital and Healthcare buildings
 - Number of beds in the spaces served by the water heater.
 - Application type: Offices, Schools, and Universities.
 - Daily occupancy in the spaces served by the water heater.
 - Application type: Other Commercial buildings.
 - Gross building floor area served by the water heater.
- Climate Zone: Rockford, Chicago, Springfield, Belleville, Marion
- Baseline water heater type, firing rate, storage volume and rated stand by loss for measure type Time of sale (TOS).
- CCTWH array firing rate, storage volume, peak flow rate at 70°F ΔT and rated standby loss.

This measure was developed to be applicable to the following program types: NC and TOS. If applied to other program types, the measure savings should be verified.

DEFINITION OF EFFICIENT EQUIPMENT

Central Condensing Tankless Water Heater array (CCTWH array) are formed by integrating individual gas fired condensing tankless water heating units into a modular system with specific system controls. Gas fired Instantaneous or Tankless water heaters shall produce not less than 4,000 Btu/hr per gallon of storage as defined by federal code for regulations⁵⁷⁰. CCTWH array system to be used as part of this measure should be greater than 200,000 Btu/hr

⁵⁶⁷Gas fired Instantaneous water heater as defined in code for federal regulations. [eCFR :: 10 CFR Part 431 Subpart G -- Commercial Water Heaters, Hot Water Supply Boilers and Unfired Hot Water Storage Tanks](#)

⁵⁶⁸ Externally attached spreadsheet tool 'Energy Savings Calculator for Central Condensing Tankless Water Heater Array.xlsm'.

⁵⁶⁹ Building type definitions are as defined in Illinois Technical Reference Manual version 11, Volume 1: Overview and User Guide, Section 3.6 Glossary. [IL-TRM Effective 010123 v11.0 Vol 1 Overview 09222022 FINAL.pdf \(ilsag.info\)](#)

⁵⁷⁰ Gas fired Instantaneous water heater as defined in code for federal regulations. [eCFR :: 10 CFR Part 431 Subpart G -- Commercial Water Heaters, Hot Water Supply Boilers and Unfired Hot Water Storage Tanks](#)

and produce not less than 4,000 Btu/hr per gallon of stored water. CCTWH array system as a part of the measure shall have a rated thermal efficiency greater than 90%.

DEFINITION OF BASELINE EQUIPMENT

Time of Sale: This measure type is only applicable for existing commercial gas fired water heaters being replaced after the end of their useful life. The baseline condition is assumed to be a new standard water heater of same type as the existing unit being replaced. The efficiency of the baseline water heater in this case, would be or minimum efficiency as required by the federal standards⁵⁷¹. If existing equipment type is unknown, the baseline condition is assumed to be a standard commercial gas fired storage type water heater meeting federal minimal efficiency standards listed in table below.

New Construction: The baseline condition is assumed to be a new standard commercial gas fired storage type water heater meeting federal minimum efficiency standards listed in table below.

Equipment Type ⁵⁷²	Sub Category	Draw Pattern	Federal Standard – Uniform Energy Factor
<u>Commercial</u> Gas Storage Water Heaters (Including Storage water heaters and Service hot water boilers with external storage tanks)	>75,000 Btu/hr	All	80% E _{thermal} , Btu/hr Standby Losses = (Q /800 + 110vRated Storage Volume in Gallons), Btu/hr
<u>Commercial</u> Gas Instantaneous Water Heaters	<10 gal and >200,000 Btu/hr	All	80% E _{thermal} , Btu/hr Standby Losses = NA
	≥10 gal and >200,000 Btu/hr	All	80% E _{thermal} , Btu/hr Standby Losses = (Q /800 + 110vRated Storage Volume in Gallons), Btu/hr

For the purpose of calculating baseline water heater standby losses in measure type NC, Capacity of the Baseline water heater (NC) is calculated as follows:

(NC)Baseline water heater capacity (Btu/hr) = Recovery demand * ΔT * 8.33/η

Recovery demand (gph) = Peak flow (gpm) * 30

Peak flow (gpm) = Peak flow of the CCTWH array at 70 °F ΔT temperature rise.

30 = A peak flow of 30 minutes is assumed to estimate peak gallons per hour recovery demand.

8.33 = 8.33 lb/gal of water

η = 0.8 (Efficiency of the (NC) Baseline water heater)

(NC) Baseline water heater storage (Gal) = (NC) Baseline water heater capacity (Btu/hr) /3,999

⁵⁷¹ Residential-Duty and Commercial Federal Standard are from DOE Standard 10 CFR 431. [eCFR :: 10 CFR Part 431 Subpart G -- Commercial Water Heaters, Hot Water Supply Boilers and Unfired Hot Water Storage Tanks](#)

⁵⁷² Commercial Water heater equipment type definitions are per U.S Department of Energy, federal code for regulation standards.

3,999 = Conversion factor to estimate minimum storage volume to be defined as a storage type water heater per U.S. federal code for standards.

Note that (NC) Baseline water heater capacity and (NC) Baseline water heater storage are only utilized to calculate baseline system standby loss for calculating measure energy savings.

DEEMED LIFETIME OF EFFICIENT EQUIPMENT

The expected measure life is assumed to be 20 years⁵⁷³.

DEEMED MEASURE COST

Actual costs should be used where available. Total equipment cost assumptions for the measure can be used from table below if actual costs are unknown. Depending on actual site demand requirements, CCTWH array is expected to have higher firing rate than a storage water heater, to meet the same hot water demand. While computing incremental costs for this measure, corresponding firing rates shall be utilized for the Baseline water heater and the CCTWH array.

Capacity	Total Equipment Cost- CCTWH Array	Total Equipment Cost Baseline ⁵⁷⁴	
		Storage Type Water Heater	Service Hot Water Boiler with Storage Tanks
≤800 kBtu/hr	14.45 \$/kBtu/hr ⁵⁷⁵	34.67 \$/kBtu/hr	27.50 \$/kBtu/hr
>800 kBtu/hr	31.21 \$/kBtu/hr ⁵⁷⁶		

Incremental Cost = (Unit Cost CCTWH Array * Eff firing rate) – (Unit Cost Baseline * Baseline firing rate)

Unit Cost = Cost per firing rate of the water heating equipment (\$/kBtu/hr).

Eff firing rate = Firing rate(kBtu/hr) of the Central condensing tankless water heater array.

Baseline firing rate = Firing rate(kBtu/hr) of the Baseline domestic water heater.

For baseline water heater firing rate in measure type NC, refer to Definition of baseline equipment section.

LOADSHAPE

N/A

COINCIDENCE FACTOR

N/A

⁵⁷³ California ETRM, Tankless water heater commercial measure (Version SWWH006-07) lists a useful life of 20 years. California Public Utilities Commission (CPUC), Energy Division. 2014. "DEER2014-EUL-table-update_2014-02-05.xlsx."

<https://www.caetrm.com/login/?next=/measure/SWWH006/07/>

⁵⁷⁴ Baseline install costs are based on data from [2010-2012 WO017 Ex Ante Measure Cost Study - Final Report.pdf \(calmac.org\)](https://www.calmac.org). Only equipment and miscellaneous costs are considered excluding labor costs for a non-condensing 82% TE storage type water heater. Average of equipment and miscellaneous costs for Large storage water heater Et=80% and SHW Boilers Et=82% are used to estimate equipment cost per kBtu/hr.

⁵⁷⁵ Install cost from Swierczyna, R., P. Glanville, M. Mensinger Jr., A. Haynor, B. Schoenbauer. 2022. Demonstration of Packaged Central Condensing Tankless Water Heating Systems in Multifamily Buildings. Minnesota Commerce Department. <https://mn.gov/commerce/energy/conserving-energy/applied-research-development/>

⁵⁷⁶ Install cost for CCTWH array greater than 800 kBtu/hr are from GTI Energy field demonstration projects in Illinois.

Algorithm

CALCULATION OF ENERGY SAVINGS

ELECTRIC ENERGY SAVINGS

There are no anticipated electrical energy savings for this measure.

SUMMER COINCIDENT PEAK DEMAND SAVINGS

N/A

FOSSIL FUEL SAVINGS

$$\Delta \text{Therms} = \{ [G \times 8.33 \times 1 \times (T_{out} - T_{in}) \times ((1/\eta_{base}) - (1/\eta_{eff}))] + (S_{Lbase} - S_{Leff}) \} / 1,000,00$$

Where:

- G = Annual hot water use (in gallons).
- = Actual annual hot water usage (If hot water usage is metered in measure type TOS)
- = Average daily hot water use x Operating days in a year. (if daily use is listed in table below.
- Operating days in a year = Actual or If unknown, use values from table below.

Building Type ^{577 578}	Operating Days per Year
Offices	250
Restaurant	365
Retail	365
Grocery stores/ Convenience stores	365
Warehouses	250
Schools	200
Universities	200
Health	365
Hotels, Motels	365
Multifamily	365
Other Commercial	250

Average daily hot water use to be calculated from table below based on building type.

Building Type	Consumption	Unit
Multi-family	36.9	Gal/unit/day ⁵⁷⁹
Hotels <=20 units	20	Gal/unit/day ⁵⁸⁰

⁵⁷⁷ Sezgan, O et al. Technology data characterizing water heating in commercial buildings: Application to end use forecasting, Ernest Orlando Lawrence Berkeley National Laboratory, December 1995. [lbnl-37398e.pdf \(lbl.gov\)](#)

⁵⁷⁸ 2020 State of Ohio Energy efficiency technical reference manual, Volume III: Commercial and Industrial market sector. "Technical Reference Manual (TRM) for Ohio Senate Bill 221 Energy Efficiency and Conservation Program and 09-512-GEUNC", October 15, 2009. Based on Ohio utility supply profiles. [ViewImage.aspx \(state.oh.us\)](#)

⁵⁷⁹ 2022 IL Technical reference manual, measure 4.3.7, referenced Deoreo, B., and P. Mayer. Residential End Uses of Water Study Update. Forthcoming. ©2015 Water Research Foundation.

⁵⁸⁰ 2019 ASHRAE Applications handbook, chapter 51 service water heating for Hotels, Schools/ Universities and offices water consumption.

Hotels 21-99 Units	14	Gal/unit/day
Hotels 100+ units	10	Gal/unit/day
School (Jr/Sr High)	1.8	Gal/student/day
Elementary school	0.6	Gal/student/day
Universities	1.8	Gal/person/day
Hospitals	18.4	Gal/bed/day
Office	1	Gal/person/day
Retail >=30,000 SF	1,354	Gal/1000 SF/year ⁵⁸¹
Retail < 30,000 SF	6,111	Gal/1000 SF/year
Restaurants	44,439	Gal/1000 SF/year
Grocery store	697	Gal/1000 SF/year
Convenience	4,594	Gal/1000 SF/year
Warehouse	1,239	Gal/1000 SF/year
Other Commercial	3,941	Gal/1000 SF/year

8.33 = Density of water lb/gal.

1 = Specific heat capacity of water Btu/lb °F.

Tout = water heater set point (°F) (demand temperature) is assumed to be 125 °F. If custom higher water temperatures are used, actual tank water temperature should be verified.

Tin = Average inlet water temperature (°F) is based on the building location nearest to zones listed in table below.

Typical Entering Cold-Water Temperatures ⁵⁸² in °F			
Zones	Min	Avg	Max
(1)Rockford	40.86	53.80	66.31
(2)Chicago O’Hare	44.10	56.17	67.85
(3)Springfield	46.05	59.38	72.30
(4)Belleville	48.24	60.08	71.55
(5)Marion	49.63	62.09	74.19

η_{base} = Rated efficiency of baseline water heater in Thermal efficiency (Et) can be actual value if known or can be taken from per table in definition of baseline equipment.

η_{new} = Rated efficiency of the efficient CCTWH array in Thermal efficiency (Et).

SLbase = Annual Standby energy loss of the baseline water heater in btu.
 = SL rated base X H

SL rated base = Rated Standby loss rating of the baseline water heater in Btu/hr.
 = Actual or if unknown, Use calculation below to estimate standby losses.
 = (Q /800 + 110vRated Storage Volume in Gallons), Btu/hr

⁵⁸¹ 2022 IL Technical reference manual, version 11, volume 2, section 4.3.1., lists consumption/ cap for retail spaces, restaurants, grocery stores, convenience stores, Warehouses and other commercial spaces. Update with reference from 4.3.1

⁵⁸² Cold water temperatures are taken From US DOE, Building America Analysis Spreadsheets

- Q = Capacity/ Firing rate of the Baseline water heater in Btu/hr
- H = 8760 annual hours of operation is assumed for estimating stand by losses.
- SL_{eff} = Annual Standby energy loss of the efficient CCTWH array in btu.
= SL rated eff X H
- SL rated eff = Rated Standby loss rating of the efficient CCTWH array in Btu/hr
= or Actual Standby loss rating values based on CCTWH system operation. This will need to be verified to be utilized in the measure.
=If unknown and CCTWH array rated storage volume is greater than or equal to 10 gallons, assume a standby loss of,
$$Q_{eff} / 800 + 110 \times \text{Rated Storage Volume in Gallons}), \text{ Btu/hr}$$
- Q_{eff} = Capacity/ Firing rate of the CCTWH array in Btu/hr.

For example, savings for a CCTWH array with 796 kbtu/hr input rating, 20 gpm peak flow at 70 °F ΔT and 96% TE is installed serving 23 units in a multi-family building in Chicago, replacing a storage type water heater 199 kbtu/hr input rating, 100-gallon storage and 80% TE, is calculated as follows:

Following inputs listed below shall be utilized to estimate Therms savings in the external spreadsheet calculator.

Description	Input	Calculated Annual Therms Savings
Measure type	Time of Sale (TOS)	489 Therms
Building Type	Multi-family	
Number of units served by the water heater	23	
Building location: Climate Zone	Climate Zone2: Chicago	
Baseline water heater type	Commercial gas fired storage water heater	
Baseline water heater Firing rate input	199 kbtu/hr	
Baseline water heater storage capacity	100 Gallons	
CCTWH array system firing rate input	796 kbtu/hr	
CCTWH array system Thermal efficiency	96%	

The same example; when a CCTWH array with 796 kbtu/hr input rating, 20 gpm peak flow at 70 °F ΔT and 96% TE is installed serving 23 units in a multi-family building in Chicago is installed in New Construction, Hot water energy savings are estimated as based on input listed below.

Description	Input	Calculated Annual Therms Savings
Measure type	New Construction (NC)	518 Therms
Building Type	Multi-family	
Number of units served by the water heater	23	
Building location: Climate Zone	Climate Zone2: Chicago	
Baseline water heater type	Commercial gas fired storage water heater	
CCTWH array system firing rate input	796 kbtu/hr	
CCTWH array system Thermal efficiency	96%	
CCTWH array system Peak flow at 70 °F temperature rise	20 gpm	

WATER AND OTHER NON-ENERGY IMPACT DESCRIPTIONS AND CALCULATION

N/A

DEEMED O&M COST ADJUSTMENT CALCULATION

N/A

MEASURE CODE: CI-HWE-TWHA-V01-240101

REVIEW DEADLINE: 1/1/2029

4.4. HVAC End Use

Many of the commercial HVAC measures use equivalent full load hours (EFLH) to calculate heating and cooling savings. The tables with these values are included in this section and referenced in each measure.

To calculate the updated EFLHs by building type and climate zone provided below, most of the eQuest models that were previously developed by a TAC Subcommittee utilizing building energy models originally developed for ComEd⁵⁸³, were migrated to OpenStudio by a parametric calibration process. The parametric runs were controlled with a genetic learning algorithm to characteristically adjust the seed models to achieve an acceptable target error against the existing eQuest model population. The breadth of the characteristic variations was informed through a sensitivity analysis, the IL joint assessment survey, and the existing eQuest models. The DOE prototypical models served as the initial seed model for most instances of calibration except where a direct map to available prototypes was unavailable.

The building characteristics of the eQuest models can be found in the reference table named “EFLH Building Descriptions Updated 2014-11-21.xlsx”. The OpenStudio models are based upon the DOE Prototypes described in NREL’s “U.S. Department of Energy Commercial Reference Building Models of the National Building Stock” and a calibration log file that documents all of the variations made to each model to get them calibrated is provided in “IL-Calibration-Log_2019-08-27.xlsx”. These documents and all the models are all available on the SharePoint site.

Note, for greenhouse boiler control measures, like Modulating Boiler Controls and/or Boiler Oxygen Trim Controls it is recommended to use methodology detailed in 4.4.21 Linkageless Boiler Controls for Space Heating and 4.4.22 Oxygen Trim Controls for Space Heating Boilers, respectively.

Note where a measure installation is within a building or application that does not fit with any of the defined building types below, the user should apply custom assumptions where it is reasonable to estimate them, else the building of best fit should be utilized.

Equivalent Full Load Hours for Heating (EFLH_{Heating}) for Existing Buildings:

Building Type	Heating EFLH Existing Buildings					Model Source
	Zone 1 (Rockford)	Zone 2 (Chicago)	Zone 3 (Springfield)	Zone 4 (Belleville)	Zone 5 (Marion)	
Assembly	1,787	1,831	1,635	1,089	1,669	eQuest
Assisted Living	1,683	1,646	1,446	1,063	1,277	eQuest
Auto Dealership	2,981	2,950	2,694	2,368	2,437	eQuest
College	1,256	1,293	1,138	1,116	1,131	OpenStudio
Convenience Store	1,481	1,368	1,214	871	973	eQuest
Drug Store	2,848	2,947	2,568	2,362	2,516	eQuest
Elementary School	1,614	1,603	1,409	1,209	1,269	OpenStudio
Emergency Services	2,757	2,670	2,383	2,149	2,186	eQuest
Garage	985	969	852	680	752	eQuest
Greenhouse – w/ Curtains	4,320	4,059	3,493	2,996	2,933	Virtual Grower 3.1
Greenhouse – w/o Curtains	4,344	4,081	3,513	3,012	2,949	Virtual Grower 3.1
Grocery	1,467	1,551	1,364	1,367	1,375	eQuest
Healthcare Clinic	1,446	1,526	1,452	1,553	1,574	OpenStudio
High School	1,807	1,855	1,649	1,591	1,622	eQuest
Hospital - CAV no econ ⁵⁸⁴	1,216	1,220	1,072	1,001	1,028	OpenStudio
Hospital - CAV econ ⁵⁸⁵	1,387	1,398	1,252	1,222	1,269	OpenStudio

⁵⁸³ A full description of the ComEd model development is found in “ComEd Portfolio Modeling Report. Energy Center of Wisconsin July 30, 2010”.

⁵⁸⁴ Based on model with single duct reheat system with a fixed outdoor air volume.

⁵⁸⁵ Based on model with single duct reheat system with airside economizer controls, with constant volume zone reheat boxes and single speed fan motors.

Building Type	Heating EFLH Existing Buildings					Model Source
	Zone 1 (Rockford)	Zone 2 (Chicago)	Zone 3 (Springfield)	Zone 4 (Belleville)	Zone 5 (Marion)	
Hospital - VAV econ ⁵⁸⁶	665	697	628	646	615	OpenStudio
Hospital - FCU	1,622	1,571	1,374	1,220	1,281	OpenStudio
Hotel/Motel	1,597	1,634	1,468	1,376	1,451	OpenStudio
Hotel/Motel - Common	1,670	1,733	1,549	1,496	1,557	OpenStudio
Hotel/Motel - Guest	1,555	1,597	1,433	1,316	1,400	OpenStudio
Manufacturing Facility	1,048	1,013	939	567	634	eQuest
MF - High Rise	1,565	1,540	1,448	1,089	1,125	OpenStudio
MF - High Rise - Common	537	558	501	480	499	OpenStudio
MF - High Rise - Residential	1,665	1,666	1,512	1,145	1,207	OpenStudio
MF - Mid Rise	1,730	1,782	1,589	1,538	1,560	OpenStudio
Movie Theater	1,916	1,905	1,718	1,288	1,538	eQuest
Office - High Rise - CAV no econ	995	1,036	933	786	832	OpenStudio
Office - High Rise - CAV econ	1,001	1,051	929	803	851	OpenStudio
Office - High Rise - VAV econ	1,552	1,432	1,239	1,077	1,098	OpenStudio
Office - High Rise - FCU	1,015	993	899	773	809	OpenStudio
Office - Low Rise	2,825	2,625	2,365	2,007	2,040	eQuest
Office - Mid Rise	1,672	1,629	1,454	1,356	1,399	OpenStudio
Religious Building	1,603	1,504	1,440	1,054	1,205	eQuest
Restaurant	1,326	1,328	1,179	1,091	1,122	OpenStudio
Retail - Department Store	1,365	1,322	1,193	1,034	1,088	OpenStudio
Retail - Strip Mall	1,347	1,325	1,183	1,064	1,096	OpenStudio
Warehouse	1,285	1,286	1,180	1,147	1,224	OpenStudio
Unknown	1,709	1,678	1,508	1,287	1,411	n/a

Equivalent Full Load Hours for Heating (EFLH_{Heating}) for New Construction:

Building Type	Heating EFLH New Construction					Model Source
	Zone 1 (Rockford)	Zone 2 (Chicago)	Zone 3 (Springfield)	Zone 4 (Belleville)	Zone 5 (Marion)	
Auto Dealership	1,286	1,185	1,279	1,138	1,078	OpenStudio
College	942	834	906	831	818	OpenStudio
Drug Store	1,023	930	1,017	889	822	OpenStudio
Elementary School	949	878	943	861	859	OpenStudio
Emergency Services	480	352	501	407	347	OpenStudio
Grocery	2,795	2,788	2,549	2,380	2,597	OpenStudio
Healthcare Clinic	1,534	1,417	1,555	1,395	1,371	OpenStudio
High School	1,502	1,549	1,368	1,283	1,299	OpenStudio
Hospital - CAV no econ	2,345	2,207	2,318	2,110	2,195	OpenStudio
Hospital - CAV econ	2,345	2,207	2,318	2,110	2,195	OpenStudio
Hospital - VAV econ	2,345	2,207	2,318	2,110	2,195	OpenStudio
Hospital - FCU	2,345	2,207	2,318	2,110	2,195	OpenStudio
Hotel/Motel - Residential	1,412	1,243	1,439	1,405	1,146	OpenStudio
Hotel_Motel_Common	1,554	1,415	1,519	1,410	1,361	OpenStudio

⁵⁸⁶ Based on model with single duct reheat system with airside economizer controls, zone VAV reheat boxes and VFD fan motors.

Building Type	Heating EFLH New Construction					Model Source
	Zone 1 (Rockford)	Zone 2 (Chicago)	Zone 3 (Springfield)	Zone 4 (Belleville)	Zone 5 (Marion)	
Hotel_Motel_Guest	1,538	1,083	1,554	1,381	987	OpenStudio
MF - High Rise	1,308	884	1,361	1,125	865	OpenStudio
MF - High Rise - Common	1,581	1,280	1,590	1,349	1,220	OpenStudio
MF - High Rise - Residential	1,352	946	1,413	1,174	917	OpenStudio
MF - Mid Rise	1,637	1,385	1,637	1,434	1,322	OpenStudio
Office - High Rise - FCU	987	870	1,001	893	837	OpenStudio
Office - High Rise - VAV econ	987	870	1,001	893	837	OpenStudio
Office - Mid Rise	867	759	892	792	701	OpenStudio
Office - High Rise - CAV no econ	967	854	971	876	804	OpenStudio
Office Low Rise	954	916	826	667	664	OpenStudio
Restaurant	787	797	671	811	820	OpenStudio
Retail - Department Store	1,286	1,185	1,279	1,138	1,078	OpenStudio
Retail - Strip Mall	973	867	972	857	777	OpenStudio
Warehouse	1,413	1,390	1,398	1,298	1,290	OpenStudio
Unknown	1,133	1,064	1,091	982	960	n/a

Equivalent Full Load Hours for Cooling (EFLH_{cooling}) for Existing Buildings:

Building Type	Cooling EFLH Existing Buildings					Model Source
	Zone 1 (Rockford)	Zone 2 (Chicago)	Zone 3 (Springfield)	Zone 4 (Belleville)	Zone 5 (Marion)	
Assembly	725	796	937	1,183	932	eQuest
Assisted Living	1,475	1,457	1,773	2,110	1,811	eQuest
Auto Dealership	996	1,051	1,343	1,582	1,414	eQuest
College	572	564	676	776	613	OpenStudio
Convenience Store	1,088	1,067	1,368	1,541	1,371	eQuest
Drug Store	858	943	1,133	1,279	1,092	eQuest
Elementary School	834	837	999	1264	967	OpenStudio
Emergency Services	2,983	3,009	3,762	4,030	3,740	eQuest
Garage	934	974	1,226	1,582	1,383	eQuest
Grocery	826	914	1,151	1,329	1,240	eQuest
Healthcare Clinic	1,220	1,294	1,505	1,658	1,534	OpenStudio
High School	892	883	1,066	1,397	1,018	eQuest
Hospital - CAV no econ	1,719	1,799	2,068	2,238	2,066	OpenStudio
Hospital - CAV econ	1,267	1,302	1,604	1,798	1,592	OpenStudio
Hospital - VAV econ	3,313	3,332	3,458	3,546	3,311	OpenStudio
Hospital - FCU	1,575	1,562	1,921	1,979	1,812	OpenStudio
Hotel/Motel	1,106	1,148	1,453	1,605	1,435	OpenStudio
Hotel/Motel - Common	1,108	1,168	1,430	1,574	1,406	OpenStudio
Hotel/Motel - Guest	1,061	1,106	1,391	1,509	1,401	OpenStudio
Manufacturing Facility	1,010	1,055	1,209	1,453	1,273	eQuest
MF - High Rise	928	920	1,059	1,360	1,205	OpenStudio
MF - High Rise - Common	1,405	1,383	1,479	1,527	1,466	OpenStudio
MF - High Rise - Residential	764	807	976	1,216	1,147	OpenStudio
MF - Mid Rise	787	855	1,099	1,198	1,082	OpenStudio
Movie Theater	876	745	1,036	1,178	1,010	eQuest

Building Type	Cooling EFLH Existing Buildings					Model Source
	Zone 1 (Rockford)	Zone 2 (Chicago)	Zone 3 (Springfield)	Zone 4 (Belleville)	Zone 5 (Marion)	
Office - High Rise - CAV no econ	1,357	1,404	1,587	1,753	1,468	OpenStudio
Office - High Rise - CAV econ	922	937	1,138	1,274	1,000	OpenStudio
Office - High Rise - VAV econ	847	887	991	1,092	893	OpenStudio
Office - High Rise - FCU	1,083	1,116	1,269	1,348	1,266	OpenStudio
Office - Low Rise	1,796	1,790	2,233	2,342	2,219	eQuest
Office - Mid Rise	1,128	1,153	1,360	1,461	1,356	OpenStudio
Religious Building	861	817	967	1,159	1,067	eQuest
Restaurant	990	1,021	1,273	1,411	1,290	OpenStudio
Retail - Department Store	639	640	775	936	812	OpenStudio
Retail - Strip Mall	697	720	915	998	930	OpenStudio
Warehouse	252	265	363	377	379	OpenStudio
Unknown	1,003	1,019	1,230	1,403	1,236	n/a

Equivalent Full Load Hours for Cooling (EFLH_{cooling}) for New Construction:

Building Type	Cooling EFLH New Construction					Model Source
	Zone 1 (Rockford)	Zone 2 (Chicago)	Zone 3 (Springfield)	Zone 4 (Belleville)	Zone 5 (Marion)	
Auto Dealership	806	923	792	938	1,028	OpenStudio
College	925	990	994	1,156	1,217	OpenStudio
Drug Store	813	931	744	836	1,083	OpenStudio
Elementary School	724	821	732	753	999	OpenStudio
Emergency Services	379	429	371	423	576	OpenStudio
Grocery	643	568	569	562	511	OpenStudio
Healthcare Clinic	1,964	2,093	1,932	2,055	2,221	OpenStudio
High School	1,807	1,642	2,093	2,292	1,830	OpenStudio
Hospital - CAV no econ	2,627	2,751	2,662	2,782	2,962	OpenStudio
Hospital - CAV econ	2,627	2,751	2,662	2,782	2,962	OpenStudio
Hospital - VAV econ	2,627	2,751	2,662	2,782	2,962	OpenStudio
Hospital - FCU	2,627	2,751	2,662	2,782	2,962	OpenStudio
Hotel/Motel - Residential	1,639	1,836	1,712	1,851	1,983	OpenStudio
Hotel_Motel_Common	2,343	2,472	2,286	2,400	2,590	OpenStudio
Hotel_Motel_Guest	788	1,024	846	1,073	1,164	OpenStudio
MF - High Rise	1,338	1,705	1,287	1,500	1,932	OpenStudio
MF - High Rise - Common	773	912	751	878	972	OpenStudio
MF - High Rise - Residential	1,299	1,663	1,245	1,451	1,882	OpenStudio
MF - Mid Rise	1,341	1,633	1,245	1,492	1,818	OpenStudio
Office - High Rise - FCU	1,296	1,465	1,281	1,477	1,574	OpenStudio
Office - High Rise - VAV econ	1,296	1,465	1,281	1,477	1,574	OpenStudio
Office - High Rise - CAV no econ	1,433	1,644	1,411	1,632	1,793	OpenStudio
Office - High Rise - CAV econ	1,361	1,375	1,604	1,715	1,617	OpenStudio
Office - Mid Rise	957	1,149	958	1,122	1,270	OpenStudio
Office Low Rise	947	989	1,090	1,302	1,076	OpenStudio
Restaurant	768	761	1,034	1,110	994	OpenStudio
Retail - Department Store	806	924	796	939	1,027	OpenStudio

Building Type	Cooling EFLH New Construction					Model Source
	Zone 1 (Rockford)	Zone 2 (Chicago)	Zone 3 (Springfield)	Zone 4 (Belleville)	Zone 5 (Marion)	
Retail - Strip Mall	722	789	667	834	911	OpenStudio
Warehouse	389	522	408	527	567	OpenStudio
Unknown	984	1,045	1,047	1,177	1,176	n/a

4.4.1 Air Conditioner Tune-up

DESCRIPTION

An air conditioning system that is operating as designed saves energy and provides adequate cooling and comfort to the conditioned space

DEFINITION OF EFFICIENT EQUIPMENT

In order for this characterization to apply, the efficient equipment is assumed to be a unitary or split system air conditioner at least 3 tons and preapproved by program. The measure requires that a certified technician performs the following items:

- Check refrigerant charge
- Identify and repair leaks if refrigerant charge is low
- Measure and record refrigerant pressures
- Measure and record temperature drop at indoor coil
- Clean condensate drain line
- Clean outdoor coil and straighten fins
- Clean indoor and outdoor fan blades
- Clean indoor coil with spray-on cleaner and straighten fins
- Repair damaged insulation – suction line
- Change air filter
- Measure and record blower amp draw

A copy of contractor invoices that detail the work performed to identify tune-up items, as well as additional labor and parts to improve/repair air conditioner performance must be submitted to the program.

DEFINITION OF BASELINE EQUIPMENT

In order for this characterization to apply, the baseline condition is assumed to be an AC system that that does not have a standing maintenance contract or a tune up within in the past 36 months.

DEEMED LIFETIME OF EFFICIENT EQUIPMENT

The expected measure life is assumed to be 3 years.⁵⁸⁷

DEEMED MEASURE COST

Tune-up costs can vary considerably, particularly if refrigerant leak detection, remediation and recharge is necessary. Actual invoiced tune-up costs should be used.

LOADSHAPE

Loadshape C03 - Commercial Cooling

COINCIDENCE FACTOR

- CF_{SSP} = Summer System Peak Coincidence Factor for Commercial cooling (during system peak hour)
= 91.3%⁵⁸⁸
- CF_{PJM} = PJM Summer Peak Coincidence Factor for Commercial cooling (average during peak period)

⁵⁸⁷3 years is given for “Clean Condenser Coils – Commercial” and “Clean Evaporator Coils”. DEER2014 EUL Table.

⁵⁸⁸Based on analysis of Itron eShape data for Missouri, calibrated to Illinois loads, supplied by Ameren. The AC load during the utility’s peak hour is divided by the maximum AC load during the year.

$$= 47.8\%^{589}$$

Algorithm

CALCULATION OF SAVINGS

ELECTRIC ENERGY SAVINGS

$$\Delta kWH = (kBtu/hr) * [(1/EERbefore) - (1/EERafter)] * EFLH$$

Where:

- kBtu/hr = capacity of the cooling equipment actually installed in kBtu per hour (1 ton of cooling capacity equals 12 kBtu/hr).
=Actual
- EERbefore = Energy Efficiency Ratio of the baseline equipment prior to tune-up⁵⁹⁰
=Actual
- EERafter = Energy Efficiency Ratio of the baseline equipment after to tune-up
=Actual
- EFLH = Equivalent Full Load Hours for cooling in Existing Buildings are provided in section 4.4 HVAC End Use

Where it is not possible or appropriate to perform Test in and Test out of the equipment, the following deemed methodology can be used:

$$\Delta kWh = (kBtu/hr) / EERbefore * EFLH * \%Savings$$

Where:

- %Savings = Deemed percent savings per Tune-Up component. These are additive if condenser cleaning, evaporator cleaning and refrigerant charge correction are performed (totals provided below)⁵⁹¹

Tune-Up Component	% Savings
Condenser Cleaning	6.10%
Evaporator Cleaning	0.22%
Refrig. Charge Off. <=20%	0.68%
Refrig. Charge Off. >20%	8.44%

⁵⁸⁹Based on analysis of Itron eShape data for Missouri, calibrated to Illinois loads, supplied by Ameren. The average AC load over the PJM peak period (1-5pm, M-F, June through August) is divided by the maximum AC load during the year.

⁵⁹⁰ In the context of this measure Energy Efficiency Ratio (EER) refers to field-measured steady-state rate of heat energy removal (e.g., cooling capacity) by the equipment in Btuh divided by the steady-state rate of energy input to the equipment in watts. This ratio is expressed in Btuh per watt (Btuh/watt). The cooling capacity may be derived using either refrigerant or air-side measurements. The measurement is performed at the outdoor and indoor environmental conditions that are present at the time the tune-up is being performed, and should be normalized using a correction function to the AHRI 210/240 Standard test conditions. The correction function should be developed based on manufacturer’s performance data. Care must be taken to ensure the unit is fully loaded and operating at or near steady-state. Generally, this requires that the outside air temperature is at least 60°F, and that the unit runs with all stages of cooling enabled for 10 to 15 minutes prior to making measurements. For more information, please see “IL TRM_Normalizing to AHRI Conditions Method”.

⁵⁹¹ Savings estimates are determined by applying the findings from DNV-GL “Impact Evaluation of 2013-2014 HVAC3 Commercial Quality Maintenance Programs”, April 2016, to simulate the inefficient condition within select eQuest models and across climate zones. The percent savings were consistent enough across building types and climate zones that it was determined appropriate to apply a single set of assumptions for all. See ‘eQuest C&I Tune up Analysis.xlsx’ for more information.

Tune-Up Component	% Savings
Combined (Refrig. Charge Off. <=20%)	7.00%
Combined (Refrig. Charge Off. >20%)	14.76%

For example, a 12 EER 5-ton rooftop air conditioner on a department store in Rockford receives a tune-up that includes both condenser and evaporator cleaning:

$$\begin{aligned} \Delta kWh &= (5 \cdot 12) / 12 * 1,392 * 6.32\% \\ &= 440 \text{ kWh} \end{aligned}$$

SUMMER COINCIDENT PEAK DEMAND SAVINGS

$$\Delta kW_{SSP} = (\text{kBtu/hr} * (1/\text{EER}_{\text{before}} - 1/\text{EER}_{\text{after}})) * CF_{SSP}$$

$$\Delta kW_{PJM} = (\text{kBtu/hr} * (1/\text{EER}_{\text{before}} - 1/\text{EER}_{\text{after}})) * CF_{PJM}$$

Where:

$$\begin{aligned} CF_{SSP} &= \text{Summer System Peak Coincidence Factor for Commercial cooling (during system peak hour)} \\ &= 91.3\%^{592} \end{aligned}$$

$$\begin{aligned} CF_{PJM} &= \text{PJM Summer Peak Coincidence Factor for Commercial cooling (average during peak period)} \\ &= 47.8\%^{593} \end{aligned}$$

Where it is not possible or appropriate to perform Test in and Test out of the equipment, the following deemed methodology can be used:

$$\Delta kW = (\text{kBtu/hr}) / \text{EER}_{\text{before}} * \% \text{Savings} * CF$$

FOSSIL FUEL SAVINGS

N/A

WATER IMPACT DESCRIPTIONS AND CALCULATION

N/A

DEEMED O&M COST ADJUSTMENT CALCULATION

N/A

MEASURE CODE: CI-HVC-ACTU-V06-250101

REVIEW DEADLINE: 1/1/2027

⁵⁹² Based on analysis of Itron eShape data for Missouri, calibrated to Illinois loads, supplied by Ameren. The AC load during the utility’s peak hour is divided by the maximum AC load during the year.

⁵⁹³Based on analysis of Itron eShape data for Missouri, calibrated to Illinois loads, supplied by Ameren. The average AC load over the PJM peak period (1-5pm, M-F, June through August) is divided by the maximum AC load during the year.

4.4.2 Space Heating Boiler Tune-up

DESCRIPTION

This measure is for a non-residential boiler that provides space heating. The tune-up will improve boiler efficiency by cleaning and/or inspecting burners, combustion chamber, and burner nozzles. Adjust air flow and reduce excessive stack temperatures, adjust burner and gas input. Check venting, safety controls, and adequacy of combustion air intake. Combustion efficiency should be measured before and after tune-up using an electronic flue gas analyzer.

DEFINITION OF EFFICIENT EQUIPMENT

To qualify for this measure the facility must, as applicable, complete the tune-up requirements listed below⁵⁹⁴ by approved technician:

- Measure combustion efficiency using an electronic flue gas analyzer
- Adjust airflow and reduce excessive stack temperatures
- Adjust burner and gas input, manual or motorized draft control
- Check for proper venting
- Complete visual inspection of system piping and insulation
- Check safety controls
- Check adequacy of combustion air intake
- Clean fireside surfaces.
- Inspect all refractory. Patch and wash coat as required.*
- Inspect gaskets on front and rear doors and replace as necessary.*
- Seal and close front and rear doors properly.*
- Clean low and auxiliary low water cut-off controls, then re-install using new gaskets.*
- Clean plugs in control piping.*
- Remove all hand hole and manhole plates. Flush boiler with water to remove loose scale and sediment.*
- Replace all hand hole and manhole plates with new gaskets.*
- Open feedwater tank manway, inspect and clean as required. Replace manway plate with new gasket.*
- Clean burner and burner pilot.
- Check pilot electrode and adjust or replace.
- Clean air damper and blower assembly.
- Clean motor starter contacts and check operation.*
- Make necessary adjustments to burner for proper combustion.
- Perform all flame safeguard and safety trip checks.
- Check all hand hole plates and manhole plates for leaks at normal operating temperatures and pressures.
- Troubleshoot any boiler system problems as requested by on-site personnel

Note: Tune-up activities marked with an asterisk (*) are eligible to be performed by internal maintenance staff at periods of boiler shutdown.

DEFINITION OF BASELINE EQUIPMENT

The baseline condition of this measure is a boiler that has not had a tune-up within the past 36 months.

⁵⁹⁴ Act on Energy Commercial Technical Reference Manual No. 2010-4, 9.2.2 Gas Boiler Tune-up

DEEMED LIFETIME OF EFFICIENT EQUIPMENT

The life of this measure is 3 years.⁵⁹⁵

DEEMED MEASURE COST

The cost of this measure is \$0.83/MBtu/hr per tune-up⁵⁹⁶

LOADSHAPE

N/A

COINCIDENCE FACTOR

N/A

Algorithm

CALCULATION OF ENERGY SAVINGS

ELECTRIC ENERGY SAVINGS

N/A

SUMMER COINCIDENT PEAK DEMAND SAVINGS

N/A

FOSSIL FUEL SAVINGS

$$\Delta \text{Therms} = (\text{Capacity} * \text{EFLH} * (((\text{Eff}_{\text{before}} + E_i) / \text{Eff}_{\text{before}}) - 1)) / 100,000$$

Where:

Capacity = Boiler gas input size (Btu/hr)
 = Custom

EFLH = Equivalent Full Load Hours for heating in Existing Buildings are provided in section 4.4 HVAC End Use

Eff_{before} = Efficiency of the boiler before the tune-up
 = Actual. Default value is 81.5%⁵⁹⁷

Note: Contractors should select a mid-level firing rate that appropriately represents the average building operating condition over the course of the heating season and take readings at a consistent firing rate for pre and post tune-up.

E_i = Efficiency improvement of the boiler tune-up measure
 = Actual. Default value is 2.3%⁵⁹⁸

100,000 = Converts Btu to therms

⁵⁹⁵ Act on Energy Commercial Technical Reference Manual No. 2010-4, 9.2.2 Gas Boiler Tune-up

⁵⁹⁶ Work Paper – Tune up for Boilers serving Space Heating and Process Load by Resource Solutions Group, January 2012

⁵⁹⁷ Guidehouse evaluation results from tune-up efficiency improvement research for Peoples Gas and North Shore Gas through their C&I and Public Sector Prescriptive Rebate Program, their Small Business Program, and their Multi-Family Programs. The evaluation included project and population data from program year’s 2018 and 2019.

⁵⁹⁸ Guidehouse evaluation results from tune-up efficiency improvement research for Peoples Gas and North Shore Gas through their C&I and Public Sector Prescriptive Rebate Program, their Small Business Program, and their Multi-Family Programs. The evaluation included project and population data from program year’s 2018 and 2019.

For example, a 1050 kBtu boiler in a Chicago high rise office records an efficiency prior to tune up of 81.5% AFUE and a 2.3% improvement in efficiency after tune up:

$$\begin{aligned}\Delta\text{therms} &= (1,050,000 * 2050 * ((0.815 + 0.023)/ 0.815 - 1)) /100,000 \\ &= 607 \text{ Therms}\end{aligned}$$

SUMMER COINCIDENT PEAK DEMAND SAVINGS

N/A

WATER IMPACT DESCRIPTIONS AND CALCULATION

N/A

DEEMED O&M COST ADJUSTMENT CALCULATION

N/A

MEASURE CODE: CI-HVC-BLRT-V07-250101

REVIEW DEADLINE: 1/1/2027

4.4.3 Process Boiler Tune-up

DESCRIPTION

This measure is for a non-residential boiler for process loads. For space heating, see measure 4.4.2. The tune-up will improve boiler efficiency by cleaning and/or inspecting burners, combustion chamber, and burner nozzles. Adjust air flow and reduce excessive stack temperatures, adjust burner and gas input. Check venting, safety controls, and adequacy of combustion air intake. Combustion efficiency should be measured before and after tune-up using an electronic flue gas analyzer.

DEFINITION OF EFFICIENT EQUIPMENT

To qualify for this measure the facility must, as applicable, complete the tune-up requirements by approved technician⁵⁹⁹ as specified below:

- Measure combustion efficiency using an electronic flue gas analyzer
- Adjust airflow and reduce excessive stack temperatures
- Adjust burner and gas input, manual or motorized draft control
- Check for proper venting
- Complete visual inspection of system piping and insulation
- Check safety controls
- Check adequacy of combustion air intake
- Clean fireside surfaces
- Inspect all refractory. Patch and wash coat as required.*
- Inspect gaskets on front and rear doors and replace as necessary.*
- Seal and close front and rear doors properly.*
- Clean low and auxiliary low water cut-off controls, then re-install using new gaskets.*
- Clean plugs in control piping.*
- Remove all hand hole and man hole plates. Flush boiler with water to remove loose scale and sediment.*
- Replace all hand hole and man hole plates with new gaskets.*
- Open feedwater tank manway, inspect and clean as required. Replace manway plate with new gasket.*
- Clean burner and burner pilot.
- Check pilot electrode and adjust or replace.
- Clean air damper and blower assembly.
- Clean motor starter contacts and check operation.*
- Make necessary adjustments to burner for proper combustion.
- Perform all flame safeguard and safety trip checks.
- Check all hand hole plates and man hole plates for leaks at normal operating temperatures and pressures.
- Troubleshoot any boiler system problems as requested by on-site personnel

Note: Tune-up activities marked with an asterisk (*) are eligible to be performed by internal maintenance staff at periods of boiler shutdown.

DEFINITION OF BASELINE EQUIPMENT

The baseline condition of this measure is a boiler that has not had a tune-up within the past 24 months and that does not have a standing maintenance contract.

⁵⁹⁹ Act on Energy Commercial Technical Reference Manual No. 2010-4, 9.2.2 Gas Boiler Tune-up

DEEMED LIFETIME OF EFFICIENT EQUIPMENT

The life of this measure is 2 year.⁶⁰⁰

DEEMED MEASURE COST

The cost of this measure is \$0.60/MBtu/hr per tune-up.⁶⁰¹

DEEMED O&M COST ADJUSTMENTS

N/A

LOADSHAPE

N/A

COINCIDENCE FACTOR

N/A

Algorithm

CALCULATION OF ENERGY SAVINGS

ELECTRIC ENERGY SAVINGS

N/A

SUMMER COINCIDENT PEAK DEMAND SAVINGS

N/A

FOSSIL FUEL SAVINGS

$$\Delta\text{Therms} = ((\text{Capacity} * 8766 * \text{UF}) / 100) * (1 - (\text{Eff}_{\text{pre}} / \text{Eff}_{\text{measured}}))$$

Where:

Capacity = Boiler gas input size (kBtu/hr)

=Custom

UF = Utilization Factor

= 41.9%,⁶⁰² or custom

Eff_{pre} = Boiler Combustion Efficiency Before Tune-Up

= Actual. Default value is 80.3%⁶⁰³

Note: Contractors should select a firing rate that appropriately represents the average operating condition and take readings at a consistent firing rate for pre and post tune-up.

Eff_{measured} = Boiler Combustion Efficiency After Tune-Up

⁶⁰⁰ U.S. Department of Energy, “Chapter 9 O&M Ideas for Major Equipment Types” in Operations & Maintenance Best Practices Guide: Release 3.0”, August 2010, 9.19 – 9.20

⁶⁰¹ Incremental costs are sourced from Nicor Gas program data and reflect an average of actual process boiler tune-up costs from projects implemented in 2020 and 2021. For more detail, see: “4.4.2 Process Boiler tune up IMC – Nicor Gas.xlsx”.

⁶⁰² Work Paper – Tune up for Boilers serving Space Heating and Process Load by Resource Solutions Group, January 2012

⁶⁰³ Guidehouse evaluation results from tune-up efficiency improvement research for Peoples Gas and North Shore Gas through their C&I and Public Sector Prescriptive Rebate Program, their Small Business Program, and their Multi-Family Programs. The evaluation included project and population data from program year’s 2018 and 2019.

= Actual. Default value is 82.6%⁶⁰⁴

100 = conversion from kBtu to therms

8766 = hours a year

For example, a 80.3% 1050 kBtu boiler is tuned-up resulting in final efficiency of 82.6%:

$$\begin{aligned}\Delta\text{therms} &= ((1050 * 8766 * 0.419) / 100) * (1 - (0.80.3 / 0.826)) \\ &= 1074 \text{ therms}\end{aligned}$$

SUMMER COINCIDENT PEAK DEMAND SAVINGS

N/A

WATER IMPACT DESCRIPTIONS AND CALCULATION

N/A

DEEMED O&M COST ADJUSTMENT CALCULATION

N/A

MEASURE CODE: CI-HVC-PBTU-V07-230101

REVIEW DEADLINE: 1/1/2026

⁶⁰⁴ Guidehouse evaluation results from tune-up efficiency improvement research for Peoples Gas and North Shore Gas through their C&I and Public Sector Prescriptive Rebate Program, their Small Business Program, and their Multi-Family Programs. The evaluation included project and population data from program year's 2018 and 2019.

4.4.4 Boiler Lockout/Reset Controls

DESCRIPTION

This measure relates to improving combustion efficiency by adding controls to non-residential space heating boilers to vary the boiler entering water temperature relative to heating load as a function of the outdoor air temperature to save energy. Energy is saved by increasing the temperature difference between the water temperature entering the boiler in the boiler's heat exchanger and the boiler's burner flame temperature. The flame temperature remains the same while the water temperature leaving the boiler decreases with the decrease in heating load due to an increase in outside air temperature. A lockout temperature is also set to prevent the boiler from turning on when it is above a certain temperature outdoors.

This measure was developed to be applicable to the following program types: RF. If applied to other program types, the measure savings should be verified.

DEFINITION OF EFFICIENT EQUIPMENT

Natural gas customer adding boiler reset controls capable of resetting the boiler supply water temperature in an inverse linear fashion with outdoor air temperature. Boiler lockout temperatures should be set to 55 °F at this time as well, to turn the boiler off when the temperature goes above a certain setpoint.

DEFINITION OF BASELINE EQUIPMENT

Existing boiler without boiler reset controls, any size with constant hot water flow.

DEEMED LIFETIME OF EFFICIENT EQUIPMENT

The life of this measure is 16 years.⁶⁰⁵

DEEMED MEASURE COST

The cost of this measure is \$612.⁶⁰⁶

LOADSHAPE

N/A

COINCIDENCE FACTOR

N/A

Algorithm

CALCULATION OF SAVINGS

ELECTRIC ENERGY SAVINGS

N/A

SUMMER COINCIDENT PEAK DEMAND SAVINGS

N/A

FOSSIL FUEL SAVINGS

$$\Delta\text{Therms} = \text{Capacity}_{\text{input}} * \text{SF} * \text{EFLH} / 100$$

Where:

⁶⁰⁵ This is intentionally longer than the assumptions found in the early replacement commercial HVAC measures as the application of boiler reset controls will occur in a variety of sites that may not be targeted for early replacement HVAC systems.

⁶⁰⁶ Nexant. Questar DSM Market Characterization Report. August 9, 2006.

Capacity_{input} = Boiler Input Capacity (kBtu/hr)

= custom

SF = Savings factor

= 8%,⁶⁰⁷ or custom

EFLH = Equivalent Full Load Hours for heating in Existing Buildings are provided in section 4.4 HVAC End Use

100 = conversion from kBtu to therms

For example, reset controls were installed on an 800 kBtu/hr boiler at a restaurant in Rockford, IL

$$\Delta\text{Therms} = 800 * 0.08 * 1,350 / 100$$

$$= 864 \text{ Therms}$$

WATER IMPACT DESCRIPTIONS AND CALCULATION

N/A

DEEMED O&M COST ADJUSTMENT CALCULATION

N/A

MEASURE CODE: CI-HVC-BLRC-V05-240101

REVIEW DEADLINE: 1/1/2029

⁶⁰⁷ Savings factor is the estimate of annual gas consumption that is saved due to adding boiler reset controls. A comparable savings factor, based on boiler tuneup savings is derived from Xcel Energy "DSM Biennial Plan-Technical Assumptions," Colorado. For further substantiation, Wisconsin Focus on Energy 2020 TRM uses 8%, citing multiple sources. And other prescriptive programs across the country consistently use between 5 and 10% savings factor (Efficiency Vermont - 2020, New York TRM, version 7.0 – 2020 (Cadmus Group, Inc. Home Energy Services Impact Evaluation, August 2012, pg. 20)).

4.4.5 Condensing Unit Heaters

DESCRIPTION

This measure applies to a gas fired condensing unit heater installed in a commercial application.

This measure was developed to be applicable to the following program types: TOS, NC. If applied to other program types, the measure savings should be verified.

DEFINITION OF EFFICIENT EQUIPMENT

In order for this characterization to apply, the efficient equipment is assumed to be a condensing unit heater up to 300 MBH with a Thermal Efficiency > 90% and the heater must be vented, and condensate drained per manufacturer specifications. The unit must be replacing existing natural gas equipment.

DEFINITION OF BASELINE EQUIPMENT

In order for this characterization to apply, the baseline condition is assumed to be a non-condensing natural gas unit heater at end of life.

DEEMED LIFETIME OF EFFICIENT EQUIPMENT

The expected measure life is assumed to be 12 years.⁶⁰⁸

DEEMED MEASURE COST

The incremental capital cost for a unit heater is equal to the input capacity in kBtu/h multiplied by \$15.56⁶⁰⁹

$$\text{Incremental cost} = \text{Capacity} * \$15.56$$

Where:

- Capacity = Nominal rating of the input capacity of the new condensing unit heater in kBtu/hr
- \$15.56 = Incremental cost per kBtu/h of input capacity of a new condensing unit heater

LOADSHAPE

N/A

COINCIDENCE FACTOR

N/A

Algorithm

CALCULATION OF SAVINGS

ELECTRIC ENERGY SAVINGS

N/A

⁶⁰⁸DEER 2008

⁶⁰⁹The incremental capitol cost is based on historic project data from Wisconsin Focus on Energy, spanning 2015 through June 2018. The data is aggregated based on 29 projects that comprised of 100 installed unit heaters. The average installed unit heater cost was \$22.64 / kBtu/h of input unit capacity. The baseline unit heater cost was estimated to be \$7.08 / kBtu/h of input unit capacity, per review of online pricing of Reznor and Modine models on Supply House’s website. The incremental cost was sourced from the 2020 Wisconsin Focus on Energy TRM, Public Service Commission of Wisconsin, Cadmus – “Unit Heaters, > 90% Thermal Efficiency (pg. 234)

SUMMER COINCIDENT PEAK DEMAND SAVINGS

N/A

FOSSIL FUEL SAVINGS

$$\Delta\text{Therms} = ((\text{Capacity} * \text{EFLH} * \text{UF}) / 100) * (1 / \text{Eff}_{\text{Base}} - 1 / \text{Eff}_{\text{EE}})$$

Where:

Capacity = Nominal rating of the input capacity of the new condensing unit heater in kBtu/hr

= Actual

UF = Utilization Factor

= 72.5%,⁶¹⁰ or custom

Eff_{Base} = Combustion Efficiency of the baseline unit heater

= Default value is 80%⁶¹¹

Eff_{EE} = Combustion Efficiency of the installed unit heater

= Actual. Default value is 90%

100 = conversion from kBtu to therms

EFLH = Equivalent Full Load Hours for in Existing Buildings or New Construction are provided in section 4.4 HVAC End Use.

For example, a 150 kBtu condensing unit heater with a combustion efficiency of 90% is installed in a garage in Rockford:

$$\begin{aligned} \Delta\text{therms} &= ((150 * 985 * 0.725) / 100) * (1 / 0.80 - 1 / 0.90) \\ &= 149 \text{ therms} \end{aligned}$$

WATER IMPACT DESCRIPTIONS AND CALCULATION

N/A

DEEMED O&M COST ADJUSTMENT CALCULATION

N/A

MEASURE CODE: CI-HVC-CUHT-V03-230101

REVIEW DEADLINE: 1/1/2027

⁶¹⁰ The utilization factor accounts for the fact that unit heaters are typically over-sized. Value as sourced from the 2020 Wisconsin Focus on Energy Technical Reference Manual, Public Service Commission of Wisconsin, Cadmus – Unit Heaters, ≥ 90% Thermal Efficiency (pg. 234)

⁶¹¹ Baseline combustion efficiency is sourced from IECC 2021 for all capacity warm-air unit heaters, gas-fired.

4.4.6 Electric Chiller

DESCRIPTION

This measure relates to the installation of a new electric chiller meeting the efficiency standards presented below. This measure could relate to the replacement of an existing unit at the end of its useful life, or the installation of a new chiller or chillers in an existing building (i.e. time of sale) or new construction.

This measure was developed to be applicable to the following program types: TOS, NC. If applied to other program types, the measure savings should be verified.

DEFINITION OF EFFICIENT EQUIPMENT

In order for this characterization to apply, the efficient equipment is assumed to exceed the efficiency requirements of the baseline defined by the program.

DEFINITION OF BASELINE EQUIPMENT

In order for this characterization to apply, the baseline equipment is assumed to meet the minimum efficiency requirements within the IECC code in effect on the date of the building permit. As code requirements and adoption can differ from municipality to municipality, the user should verify which version of code is applicable given these constraints.

Note, users should refer to the website for the Illinois Energy Conservation Code to verify the latest adopted code.

DEEMED LIFETIME OF EFFICIENT EQUIPMENT

The expected measure life is assumed to be 23 years.⁶¹²

DEEMED MEASURE COST

The incremental capital cost for this measure is provided below:

Air-Cooled Chiller Incremental Costs (\$/Ton) ⁶¹³				
Capacity (Tons)	Efficient EER (Baseline Path B FL EER = 9.70)			
	9.9	10.2	10.52	10.7
50	\$226	\$453	\$694	\$830
100	\$113	\$226	\$347	\$415
150	\$75	\$151	\$231	\$277
200	\$46	\$92	\$141	\$169
400	\$23	\$46	\$71	\$85

Air-Cooled Chiller Incremental Costs (\$/Ton)		
Efficient EER (Baseline Path B IPLV) ⁶¹⁴		
Capacity (Tons)	Efficient IPLV	\$/Ton
<150	17.7	\$73.35
	19.0	\$127.50
≥150	18.0	\$33.32
	19.3	\$56.12

⁶¹² As recommended in Navigant 'ComEd Effective Useful Life Research Report', May 2018.

(http://deeresources.com/deer0911planning/downloads/EUL_Summary_10-1-08.xls).

⁶¹³ Based on Navigant Consulting, NEEP "Incremental Cost Study Phase Two Final Report", January 2013.

⁶¹⁴ Based on San Diego Gas & Electric (SDG&E) "SWHC052 2022 CostAnalysis.xlsx", January 2022

Water Cooled Chiller Incremental Costs (Baseline Path B FL) ⁶¹⁵							
Scroll/Screw Chiller				Centrifugal Chiller			
Capacity (Tons)	Efficient kW/ton (Baseline 0.78 kW/Ton)				Efficient kW/ton (Baseline 0.64 kW/Ton)		
	0.72	0.68	0.64	0.6	0.60	0.58	0.54
50	\$114	\$164	N/a	N/a	\$62	\$99	\$172
100	\$52	\$77	N/a	N/a	\$42	\$66	\$115
150	N/a	N/a	N/a	N/a	\$31	\$49	\$86
200	N/a	N/a	\$61	\$122	N/a	N/a	\$55
400	N/a	N/a	N/a	\$16	N/a	N/a	\$22

Water Cooled Chiller Incremental Costs (Baseline Path B IPLV) ⁶¹⁶					
Scroll/Screw Chiller			Centrifugal Chiller		
Capacity (Tons)	Efficient kW/Ton	\$/Ton	Capacity (Tons)	Efficient kW/Ton	\$/Ton
< 75	0.45	\$106	< 150	0.40	\$185
	0.43	\$193		0.37	\$263
75 to 149	0.44	\$21	150 to 299	0.36	\$72
	0.42	\$39		0.34	\$275
150 to 299	0.40	\$37	300 to 399	0.35	\$158
	0.37	\$167		0.33	\$226
300 to 599	0.37	\$180	400 to 599	0.34	\$194
	0.35	\$322		0.32	\$250
>= 600	0.34	\$162	>= 600	0.34	\$66
	0.32	\$296		0.32	\$99

LOADSHAPE

Loadshape C03 - Commercial Cooling

COINCIDENCE FACTOR

The summer peak coincidence factor for cooling is provided in two different ways below. The first is used to estimate peak savings during the utility peak hour and is most indicative of actual peak benefits, and the second represents the *average* savings over the defined summer peak period and is presented so that savings can be bid into PJM’s capacity market. Both values provided are based on analysis of Itron eShape data for Missouri, calibrated to Illinois loads, supplied by Ameren.

$$CF_{SSP} = \text{Summer System Peak Coincidence Factor for Commercial cooling (during system peak hour)} \\ = 91.3\% \text{ }^{617}$$

$$CF_{PJM} = \text{PJM Summer Peak Coincidence Factor for Commercial cooling (average during peak period)} \\ = 47.8\% \text{ }^{618}$$

⁶¹⁵ Based on Navigant Consulting, NEEP “Incremental Cost Study Phase Two Final Report”, January 2013.

⁶¹⁶ Based on “Water-Cooled Chiller (WCC) (SWHC005-02) Cost Data” by Southern California Edison, November 2020 (SWHC005_Water-Cooled_Chiller_Cost_Data_2020Q3.xlsx)

⁶¹⁷ Based on analysis of Itron eShape data for Missouri, calibrated to Illinois loads, supplied by Ameren. The AC load during the utility’s peak hour is divided by the maximum AC load during the year.

⁶¹⁸ Based on analysis of Itron eShape data for Missouri, calibrated to Illinois loads, supplied by Ameren. The average AC load over the PJM peak period (1-5pm, M-F, June through August) is divided by the maximum AC load during the year.

Algorithm

CALCULATION OF SAVINGS

The enhanced electric energy savings calculation should be used as the primary method for more accurate energy savings, with the efficiencies calculated for the specific climate zone and building type for the chiller application. Where the calculated NPLV efficiency of the chiller at the specific conditions is unknown, the basic electric energy savings calculation can be used as a secondary method where the traditional industry-standard IPLV ratings may be more readily available.

ELECTRIC ENERGY SAVINGS

BASIC ELECTRIC ENERGY SAVINGS FOR WATER-COOLED CHILLERS:

$$\Delta \text{kWh} = \text{TONS} * ((\text{IPLV}_{\text{base}}) - (\text{IPLV}_{\text{vee}})) * \text{EFLH}$$

Where:

TONS = chiller actual installed cooling capacity in tons (note: 1 ton = 12,000 Btu/hr)

IPLV_{base} = efficiency of baseline equipment expressed as Integrated Part Load Value(kW/ton) obtained from current IECC Minimum Efficiency Table – Path (A). Refer to Baseline Efficiency Values by Chiller Type and Capacity in the Reference Tables & Equations section.

IPLV_{vee}⁶¹⁹ = efficiency of high efficiency equipment expressed as Integrated Part Load Value (kW/ton)⁶²⁰
 = Actual installed

EFLH = Equivalent Full Load Hours for cooling in Existing Buildings or New Construction are provided in section 4.4 HVAC End Use.

For example, using the default assumptions on the installation of a 150 Ton Centrifugal Water-Cooled Electric Chiller in a Mid-Rise Office in Rockford with an IPLV of .405 kW/ton:

$$\begin{aligned} \Delta \text{kWh} &= 150 * (0.550 - 0.405) * 1672 \\ &= 36,366 \text{ kWh} \end{aligned}$$

ENHANCED ELECTRIC ENERGY SAVINGS FOR WATER-COOLED CHILLERS:

$$\Delta \text{kWh} = \text{TONS} * ((\text{IPLV}_{\text{base}} * \text{IL}_{\text{adj}}) - (\text{NPLV} - \text{IL}_{\text{lee}})) * \text{EFLH}$$

Where:

TONS = chiller actual installed cooling capacity in tons (note: 1 ton = 12,000 Btu/hr)

IL_{adj} = adjustment factor to align IPLV_{base} to Illinois climate and building type. Refer to Table 1 below.

NPLV-IL_{lee}⁶²¹ = efficiency of proposed high efficiency equipment as Non-Standard Part Load Value (kW/ton) evaluated at Illinois adjusted conditions. All other variables to remain at AHRI standard conditions.

⁶¹⁹ Integrated Part Load Value is a seasonal average efficiency rating calculated in accordance with ARI Standard 550/590. It may be calculated using any measure of efficiency (EER, kW/ton, COP), but for consistency with IECC code requirements, it is expressed in terms of IPLV here.

⁶²⁰ Can determine IPLV from standard testing or looking at engineering specs for design conditions. Standard data is available from AHRI online Certification Directory.

⁶²¹ Calculation to be performed using manufacturer-provided efficiency ratings at custom part-load operating points specific to Illinois climate and building type. All other variables to remain at AHRI standard conditions. These custom part-load operating points are based on building load profiles generated from public domain EnergyPlus files developed by Pacific Northwest National Labs in conjunction and with oversight from ASHRAE. The different building types are reflective of certain typical

Chiller manufacturer shall evaluate their chiller’s efficiencies at the four unique part-load operating points using entering condenser water temperatures (ECWT) and the adjusted weighted percentages from Table 2 below for the applicable building space type listed⁷. Refer to following NPLV equation:

$$NPLV (kw/ton) = 1/[a/A + b/B + c/C + d/D]$$

Where: the lower case letters are the decimal values for weighting and the upper case letters are the chiller efficiency rating at each unique operating point.

EFLH = Equivalent Full Load Hours for cooling in Existing Buildings or New Construction are provided in section 4.4 HVAC End Use.

TABLE 1:

Water-Cooled Chillers ILadj Factors to IPLV (Path A) Baseline		
Space Type (occupancy schedule assumption)	Water-Cooled Chiller Type	
	Centrifugal	Screw/Scroll
Office (or unknown ⁶²²) (12hr, 5 days/week)	1.143	1.178
Hospital (24hr, 7 days/week, high occupancy during day)	1.043	1.067
High-Rise Apartments (24hr, 7 days/week, lighter occupancy during day)	1.117	1.155
Primary School (12hr, 5 days/week, seasonal)	1.082	1.127
Hotel (24hr, 7days/week)	1.159	1.186

TABLE 2:

Water-Cooled Chillers NPLV Part-Load Evaluation Conditions Adjusted to Illinois by Building Type								
Space Type	% Full Load Cooling Design for Chiller							
	25%		50%		75%		94%	
	Weight	ECWT [F]	Weight	ECWT [F]	Weight	ECWT [F]	Weight	ECWT [F]
Office (or unknown)	40.1%	68.1	38.3%	74.8	17.9%	80.4	3.7%	84.8
Hospital	15.0%	62.2	44.6%	69.8	35.6%	76.7	4.8%	83.7
High-Rise Apartments	30.1%	68.7	41.6%	73.8	21.3%	78.7	7.0%	83.4
Primary School	25.3%	67.0	26.3%	71.9	31.2%	76.1	17.2%	81.5
Hotel	47.8%	67.0	39.2%	76.1	12.2%	82.2	0.80%	86.9

occupancy schedules. See Reference Tables & Equations section at the end of this measure for additional info and supporting equations.

⁶²² Office building type is considered a reasonable estimate of the average application.

For example, using the default assumptions on the installation of a 150 Ton Centrifugal Water-Cooled Electric Chiller in a Mid-Rise Office in Rockford with an IPLV of .405 kW/ton:

$$\begin{aligned} \Delta kWh &= 150 * ((0.55 * 1.143) - (1 / ((0.401 / 0.409) + (0.383 / 0.406) + (0.179 / 0.405) + (0.037 / 0.403)))) * 1672 \\ &= 55,613.7 \end{aligned}$$

BASIC ELECTRIC ENERGY SAVINGS FOR AIR-COOLED CHILLERS:

$$\Delta kWh = TONS * ((12/IPLVbase) - (12/IPLVee)) * EFLH$$

Where:

TONS = chiller actual installed cooling capacity in tons (note: 1 ton = 12,000 Btu/hr)

IPLVbase = efficiency of baseline equipment as Integrated Part Load Value (EER) obtained from current IECC Minimum Efficiency Table – Path (A).. Refer to Baseline Efficiency Values by Chiller Type and Capacity in the Reference Tables & Equations section.

IPLVee⁶²³ = efficiency of proposed high efficiency equipment expressed as Integrated Part Load Value (EER)

EFLH = Equivalent Full Load Hours for cooling in Existing Buildings or New Construction are provided in section 4.4 HVAC End Use.

For example, using the default assumptions on the installation of a 150 Ton Centrifugal Air-Cooled Electric Chiller in a Mid-Rise Office in Rockford with an IPLV of 15:

$$\begin{aligned} \Delta kWh &= 150 * ((12 / 14) - (12 / 15)) * 1672 \\ &= 14,331.4 kWh \end{aligned}$$

ENHANCED ELECTRIC ENERGY SAVINGS FOR AIR-COOLED CHILLERS:

$$\Delta kWh = TONS * (12/(IPLVbase * lLadj) - 12/(NPLV-ILee)) * EFLH$$

Where:

TONS = chiller actual installed cooling capacity in tons (note: 1 ton = 12,000 Btu/hr)

lLadj = adjustment factor to align IPLVbase to Illinois climate and building type. Refer to Table 3 below.

NPLV-ILee⁶²⁴ = efficiency of proposed high efficiency equipment as Non-Standard Part Load Value (EER) evaluated at Illinois adjusted conditions. All other variables to remain at AHRI standard conditions. Chiller manufacturer shall evaluate their chiller’s efficiencies at the four unique part-load operating points using outdoor design dry bulb (ODDB) and the adjusted weighted percentages from Table 4 below for the applicable building space type listed. Refer to following NPLV equation:

$$NPLV (EER) = a*A + b*B + c*C + d*D$$

⁶²³ Integrated Part Load Value is a seasonal average efficiency rating calculated in accordance with AHRI Standard 550/590. It may be calculated using any measure of efficiency (EER, kW/ton, COP), but for consistency with IECC code requirements, it is expressed in terms of IPLV here. IPLV data is available from AHRI online Certification Directory or certified chiller manufacturer’s data.

⁶²⁴ Calculation to be performed using manufacturer-provided efficiency ratings at custom part-load operating points specific to Illinois climate and building type. All other variables to remain at AHRI standard conditions. These custom part-load operating points are based on building load profiles generated from public domain EnergyPlus files developed by Pacific Northwest National Labs in conjunction and with oversight from ASHRAE. The different building types are reflective of certain typical occupancy schedules. See Reference Tables & Equations section at the end of this measure for additional info and supporting equations.

Where: the lower case letters are the decimal values for weighting and the upper case letters are the chiller efficiency rating at each unique operating point.

EFLH = Equivalent Full Load Hours for cooling in Existing Buildings or New Construction are provided in section 4.4 HVAC End Use.

TABLE 3:

Air-Cooled Chillers ILadj Factors to IPLV (Path A) Baseline	
Space Type	Air-Cooled Chiller
Office (or unknown)	0.860
Hospital	0.925
High-Rise Apartments	0.866
Primary School	0.850
Hotel	0.929

TABLE 4:

Air-Cooled Chillers NPLV Part-Load Evaluation Conditions Adjusted to Illinois by Building Type								
Space Type	% Full Load Cooling Design for Chiller							
	25%		50%		75%		94%	
	Weight	ODDB [F]	Weight	ODDB [F]	Weight	ODDB [F]	Weight	ODDB [F]
Office (or unknown)	40.1%	69.1	38.3%	77.2	17.9%	83.9	3.7%	89.2
Hospital	15.0%	60.0	44.6%	70.2	35.6%	77.5	4.8%	86.6
High-Rise Apartments	30.1%	67.2	41.6%	75.9	21.3%	83.2	7.0%	89
Primary School	25.3%	68.1	26.3%	74.1	31.2%	79.6	17.2%	85.6
Hotel	47.8%	65.3	39.2%	76.9	12.2%	84.6	0.80%	85.6

For example, using the default assumptions on the installation of a 150 Ton Centrifugal Air-Cooled Electric Chiller in a Mid-Rise Office in Rockford with an IPLV of 15:

$$\begin{aligned} \Delta kWh &= 150 * (12 / (14 * .86) - (12 / ((0.401 * 15.3) + (0.383 * 15.1) + (0.179 * 15) + (0.037 * 14.9)))) * 1,672 \\ &= 51,377.5 kWh \end{aligned}$$

SUMMER COINCIDENT PEAK DEMAND SAVINGS

$$\Delta kW_{SSP} = TONS * ((PE_{base}) - (PE_{ee})) * CF_{SSP}$$

$$\Delta kW_{PJM} = TONS * ((PE_{base}) - (PE_{ee})) * CF_{PJM}$$

Where:

PE_{base} = Peak efficiency of baseline equipment expressed as Full Load (kW/ton)

PE_{ee} = Peak efficiency of high efficiency equipment expressed as Full Load (kW/ton)

= Actual installed

CF_{SSP} = Summer System Peak Coincidence Factor for Commercial cooling (during system peak hour)
 = 91.3%

CF_{PJM} = PJM Summer Peak Coincidence Factor for Commercial cooling (average during peak period)
 = 47.8%

For example, using the default assumptions on the installation of a 150 Ton Centrifugal Water-Cooled Electric Chiller in a Mid-Rise Office in Rockford with a peak efficiency of .409 kW/ton:

$$\begin{aligned} \Delta kW_{SSP} &= 150 * (.550 - .409) * .913 \\ &= 19.3 \\ \Delta kW_{PJM} &= 150 * (.550 - .409) * .478 \\ &= 10.1 \end{aligned}$$

FOSSIL FUEL SAVINGS

N/A

WATER IMPACT DESCRIPTIONS AND CALCULATION

N/A

DEEMED O&M COST ADJUSTMENT CALCULATION

N/A

REFERENCE TABLES

***Chillers Ratings-** Chillers are rated with different units depending on equipment type as shown below

Equipment Type	Unit
Air cooled, electrically operated	Full load EER Part Load EER
Water cooled, electrically operated, positive displacement (reciprocating and rotary screw and scroll)	Full Load kW/ton Part Load kW/ton
Water cooled, electrically operated, centrifugal	Full Load kW/ton Part Load kW/ton

****IPLV Equations and Standard Rating Conditions per AHRI 550/590:**

Expression Of Chiller Efficiency	Equation																																																		
Coefficient Of Performance–COP, W/W, or Energy Efficiency Ratio–EER, Btu/h/W	$IPLV \text{ or } NPLV = 0.01A + 0.42B + 0.45C + 0.12D$																																																		
Power Per Ton, kW/ton	$IPLV \text{ or } NPLV = \frac{1}{\frac{0.01}{A} + \frac{0.42}{B} + \frac{0.45}{C} + \frac{0.12}{D}}$																																																		
Chiller Energy Efficiency, Load																																																			
	<table border="1"> <thead> <tr> <th>A at 100%</th> <th>B at 75%</th> <th>C at 50%</th> <th>D at 25%</th> <th>— at 0%</th> </tr> </thead> <tbody> <tr> <td colspan="5">IPLV Rating Conditions</td> </tr> <tr> <td colspan="5">Condenser, water-cooled only:^a</td> </tr> <tr> <td>Entering water temperature, F [C]</td> <td>85 [29.4]^b</td> <td>75 [23.9]</td> <td>65 [18.3]</td> <td>65 [18.3]</td> </tr> <tr> <td>Flow rate, gpm/ton [Lps per kW]</td> <td colspan="4">3.0 [0.054]^c</td> </tr> <tr> <td>Fouling factor, h-ft²-F/Btu [m²-C/W]</td> <td colspan="4">0.00025 [0.000044]</td> </tr> <tr> <td colspan="5">Evaporator:</td> </tr> <tr> <td>Leaving water temperature, F [C]</td> <td>44 [6.7]^b</td> <td>—</td> <td>—</td> <td>44 [6.7]</td> </tr> <tr> <td>Flow rate, gpm/ton [Lps per kW]</td> <td colspan="4">2.4 [0.043]^c</td> </tr> <tr> <td>Fouling factor, h-ft²-F/Btu [m²-C/W]</td> <td colspan="4">0.0001 [0.000018]</td> </tr> </tbody> </table>	A at 100%	B at 75%	C at 50%	D at 25%	— at 0%	IPLV Rating Conditions					Condenser, water-cooled only: ^a					Entering water temperature, F [C]	85 [29.4] ^b	75 [23.9]	65 [18.3]	65 [18.3]	Flow rate, gpm/ton [Lps per kW]	3.0 [0.054] ^c				Fouling factor, h-ft ² -F/Btu [m ² -C/W]	0.00025 [0.000044]				Evaporator:					Leaving water temperature, F [C]	44 [6.7] ^b	—	—	44 [6.7]	Flow rate, gpm/ton [Lps per kW]	2.4 [0.043] ^c				Fouling factor, h-ft ² -F/Btu [m ² -C/W]	0.0001 [0.000018]			
A at 100%	B at 75%	C at 50%	D at 25%	— at 0%																																															
IPLV Rating Conditions																																																			
Condenser, water-cooled only: ^a																																																			
Entering water temperature, F [C]	85 [29.4] ^b	75 [23.9]	65 [18.3]	65 [18.3]																																															
Flow rate, gpm/ton [Lps per kW]	3.0 [0.054] ^c																																																		
Fouling factor, h-ft ² -F/Btu [m ² -C/W]	0.00025 [0.000044]																																																		
Evaporator:																																																			
Leaving water temperature, F [C]	44 [6.7] ^b	—	—	44 [6.7]																																															
Flow rate, gpm/ton [Lps per kW]	2.4 [0.043] ^c																																																		
Fouling factor, h-ft ² -F/Btu [m ² -C/W]	0.0001 [0.000018]																																																		

*****Building Types** - Generalized Occupancy Schedules of Building Types for Reference:

- Office –12 hour operation; 5 days a week
- Hospital –24 hour operation; 7 days a week; heavier occupancy during the day
- High Rise Apts – 24 hour operation; 7 days a week; lighter occupancy during the day
- Primary School – 12 hour operation; 5 days a week; seasonal
- Hotel –24 hour operation; 7 days a week

******Conversion Factors** – Equations to convert efficiency units where necessary:

- kW/ton = 12 / EER
- kW/ton = 12 / (COP x 3.412)
- COP = EER / 3.412
- COP = 12 / (kW/ton) / 3.412
- EER = 12 / kW/ton
- EER = COP x 3.412

2018 IECC Baseline Efficiency Values by Chiller Type and Capacity (effective 7/1/2019 to 12/31/2022)

TABLE C403.3.2(7)
WATER CHILLING PACKAGES — EFFICIENCY REQUIREMENTS^{a, b, c, d}

EQUIPMENT TYPE	SIZE CATEGORY	UNITS	BEFORE 1/1/2015		AS OF 1/1/2015		TEST PROCEDURE ^e
			Path A	Path B	Path A	Path B	
Air-cooled chillers	< 150 Tons	EER (Btu/W)	≥ 9.562 FL	NA ^c	≥ 10.100 FL	≥ 9.700 FL	AHRI 550/590
			≥ 12.500 IPLV		≥ 13.700 IPLV	≥ 15.800 IPLV	
	≥ 150 Tons		≥ 9.562 FL	NA ^c	≥ 10.100 FL	≥ 9.700 FL	
			≥ 12.500 IPLV		≥ 14.000 IPLV	≥ 16.100 IPLV	
Air cooled without condenser, electrically operated	All capacities	EER (Btu/W)	Air-cooled chillers without condenser shall be rated with matching condensers and complying with air-cooled chiller efficiency requirements.				
Water cooled, electrically operated positive displacement	< 75 Tons	kW/ton	≤ 0.780 FL	≤ 0.800 FL	≤ 0.750 FL	≤ 0.780 FL	
	≥ 75 tons and < 150 tons		≤ 0.630 IPLV	≤ 0.600 IPLV	≤ 0.600 IPLV	≤ 0.500 IPLV	
			≤ 0.775 FL	≤ 0.790 FL	≤ 0.720 FL	≤ 0.750 FL	
	≥ 150 tons and < 300 tons		≤ 0.615 IPLV	≤ 0.588 IPLV	≤ 0.560 IPLV	≤ 0.490 IPLV	
			≥ 0.680 FL	≥ 0.718 FL	≥ 0.660 FL	≥ 0.680 FL	
	≥ 300 tons and < 600 tons		≥ 0.580 IPLV	≥ 0.540 IPLV	≥ 0.540 IPLV	≥ 0.440 IPLV	
			≤ 0.620 FL	≤ 0.639 FL	≤ 0.610 FL	≤ 0.625 FL	
	≥ 600 tons		≤ 0.540 IPLV	≤ 0.490 IPLV	≤ 0.520 IPLV	≤ 0.410 IPLV	
			≤ 0.620 FL	≤ 0.639 FL	≤ 0.560 FL	≤ 0.585 FL	
	≤ 0.540 IPLV		≤ 0.490 IPLV	≤ 0.500 IPLV	≤ 0.380 IPLV		
Water cooled, electrically operated centrifugal	< 150 Tons	kW/ton	≤ 0.634 FL	≤ 0.639 FL	≤ 0.610 FL	≤ 0.695 FL	
	≥ 150 tons and < 300 tons		≤ 0.596 IPLV	≤ 0.450 IPLV	≤ 0.550 IPLV	≤ 0.440 IPLV	
			≤ 0.634 FL	≤ 0.639 FL	≤ 0.610 FL	≤ 0.635 FL	
	≥ 300 tons and < 400 tons		≤ 0.596 IPLV	≤ 0.450 IPLV	≤ 0.550 IPLV	≤ 0.400 IPLV	
			≤ 0.576 FL	≤ 0.600 FL	≤ 0.560 FL	≤ 0.595 FL	
	≥ 400 tons and < 600 tons		≤ 0.549 IPLV	≤ 0.400 IPLV	≤ 0.520 IPLV	≤ 0.390 IPLV	
			≤ 0.576 FL	≤ 0.600 FL	≤ 0.560 FL	≤ 0.585 FL	
	≥ 600 Tons		≤ 0.549 IPLV	≤ 0.400 IPLV	≤ 0.500 IPLV	≤ 0.380 IPLV	
			≤ 0.570 FL	≤ 0.590 FL	≤ 0.560 FL	≤ 0.585 FL	
	≤ 0.539 IPLV		≤ 0.400 IPLV	≤ 0.500 IPLV	≤ 0.380 IPLV		
Air cooled, absorption, single effect	All capacities	COP	≥ 0.600 FL	NA ^c	≥ 0.600 FL	NA ^c	AHRI 560
Water cooled absorption, single effect	All capacities	COP	≥ 0.700 FL	NA ^c	≥ 0.700 FL	NA ^c	
Absorption, double effect, indirect fired	All capacities	COP	≥ 1.000 FL	NA ^c	≥ 1.000 FL	NA ^c	
			≥ 1.050 IPLV		≥ 1.050 IPLV		
Absorption double effect direct fired	All capacities	COP	≥ 1.000 FL	NA ^c	≥ 1.000 FL	NA ^c	
			≥ 1.000 IPLV		≥ 1.050 IPLV		

a. The requirements for centrifugal chiller shall be adjusted for nonstandard rating conditions in accordance with Section C403.3.2.1 and are only applicable for the range of conditions listed in Section C403.3.2.1. The requirements for air-cooled, water-cooled positive displacement and absorption chillers are at standard rating conditions defined in the reference test procedure.
 b. Both the full-load and IPLV requirements shall be met or exceeded to comply with this standard. Where there is a Path B, compliance can be with either Path A or Path B for any application.
 c. NA means the requirements are not applicable for Path B and only Path A can be used for compliance.
 d. FL represents the full-load performance requirements and IPLV the part-load performance requirements.

2021 IECC Baseline Efficiency Values by Chiller Type and Capacity (CURRENT)

TABLE C403.3.2(3)
WATER-CHILLING PACKAGES—MINIMUM EFFICIENCY REQUIREMENTS^{a, b, c, f}

EQUIPMENT TYPE	SIZE CATEGORY	UNITS	PATH A	PATH B	TEST PROCEDURE ^e
Air cooled chillers	< 150 tons	EER (Btu/Wh)	≥ 10.100 FL	≥ 9.700 FL	AHRI 550/590
			≥ 13.700 IPLV.IP	≥ 15.800 IPLV.IP	
	≥ 150 tons		≥ 10.100 FL	≥ 9.700FL	
			≥ 14.000 IPLV.IP	≥ 16.100 IPLV.IP	
Air cooled without condenser, electrically operated	All capacities	EER (Btu/Wh)	Air-cooled chillers without condenser must be rated with matching condensers and comply with air-cooled chiller efficiency requirements		AHRI 550/590
Water cooled, electrically operated positive displacement	< 75 tons	kW/ton	≤ 0.750 FL	≤ 0.780 FL	AHRI 550/590
			≤ 0.600 IPLV.IP	≤ 0.500 IPLV.IP	
	≥ 75 tons and < 150 tons		≤ 0.720 FL	≤ 0.750 FL	
			≤ 0.560 IPLV.IP	≤ 0.490 IPLV.IP	
	≥ 150 tons and < 300 tons		≤ 0.660 FL	≤ 0.680 FL	
			≤ 0.540 IPLV.IP	≤ 0.440 IPLV.IP	
	≥ 300 tons and < 600 tons		≤ 0.610 FL	≤ 0.625 FL	
			≤ 0.520 IPLV.IP	≤ 0.410 IPLV.IP	
≥ 600 tons	≤ 0.560 FL	≤ 0.585 FL			
		≤ 0.500 IPLV.IP	≤ 0.380 IPLV.IP		
Water cooled, electrically operated centrifugal	< 150 tons	kW/ton	≤ 0.610 FL	≤ 0.695 FL	AHRI 550/590
			≤ 0.550 IPLV.IP	≤ 0.440 IPLV.IP	
	≥ 300 tons and < 400 tons		≤ 0.610 FL	≤ 0.635 FL	
			≤ 0.550 IPLV.IP	≤ 0.400 IPLV.IP	
	≥ 400 tons and < 600 tons		≤ 0.560 FL	≤ 0.595 FL	
			≤ 0.520 IPLV.IP	≤ 0.390 IPLV.IP	
	≥ 600 tons		≤ 0.560 FL	≤ 0.585 FL	
			≤ 0.500 IPLV.IP	≤ 0.380 IPLV.IP	
			≤ 0.560 FL	≤ 0.585 FL	
			≤ 0.500 IPLV.IP	≤ 0.380 IPLV.IP	
Air cooled absorption, single effect	All capacities	COP (W/W)	≥ 0.600 FL	NA ^d	AHRI 560
Water cooled absorption, single effect	All capacities	COP (W/W)	≥ 0.700 FL	NA ^d	AHRI 560
Absorption double effect, indirect fired	All capacities	COP (W/W)	≥ 1.000 FL	NA ^d	AHRI 560
			≥ 0.150 IPLV.IP		
Absorption double effect, direct fired	All capacities	COP (W/W)	≥ 1.000 FL	NA ^d	AHRI 560
			≥ 1.000 IPLV		

- a. Chapter 6 contains a complete specification of the referenced standards, which include test procedures, including the reference year version of the test procedure.
- b. The requirements for centrifugal chillers shall be adjusted for nonstandard rating conditions per Section C403.3.2.1 and are applicable only for the range of conditions listed there. The requirements for air-cooled, water-cooled positive displacement and absorption chillers are at standard rating conditions defined in the reference test procedure.
- c. Both the full-load and IPLV.IP requirements must be met or exceeded to comply with this standard. When there is a Path B, compliance can be with either Path A or Path B for any application.
- d. NA means the requirements are not applicable for Path B, and only Path A can be used for compliance.
- e. FL is the full-load performance requirements, and IPLV.IP is for the part-load performance requirements.
- f. This table is a replica of ASHRAE 90.1 Table 6.8.1-3 Water-Chilling Packages—Minimum Efficiency Requirements.

MEASURE CODE: CI-HVC-CHIL-V10-250101

REVIEW DEADLINE: 1/1/2028

4.4.7 ENERGY STAR and CEE Tier 2 Room Air Conditioner

DESCRIPTION

This measure relates to the purchase and installation of a room air conditioning unit that meets either the ENERGY STAR or CEE Tier 2 minimum qualifying efficiency specifications, in place of a baseline unit meeting minimum Federal Standard efficiency ratings presented below:⁶²⁵

Product Class (Btu/H)	Federal Standard CEER, with louvered sides	Federal Standard CEER, without louvered sides	ENERGY STAR CEER, with louvered sides	ENERGY STAR CEER, without louvered sides	CEE Tier 2 CEER
< 6,000	11.0	10.0	13.1	12.8	14.85
6,000 - 7,999			13.7		
8,000 to 10,999	10.9	9.6	14.7	13.0	14.72
11,000 to 13,999		9.5		12.8	
14,000 to 19,999	10.7	9.3	14.4	12.6	14.45
20,000 to 27,999	9.4	9.4	12.7	12.7	12.69
>= 28,000	9.0		12.2		12.15

Casement	Federal Standard (CEER)	ENERGY STAR (CEER)
Casement-only	9.5	12.8
Casement-slider	10.4	14.0

Reverse Cycle - Product Class (Btu/H)	Federal Standard CEER, with louvered sides	Federal Standard CEER, without louvered sides	ENERGY STAR CEER, with louvered sides	ENERGY STAR CEER, without louvered sides
< 14,000	N/A	9.3	N/A	12.6
>= 14,000	N/A	8.7	N/A	11.7
< 20,000	9.8	N/A	13.2	N/A
>= 20,000	9.3	N/A	12.6	N/A

This measure was developed to be applicable to the following program types: TOS. If applied to other program types, the measure savings should be verified.

⁶²⁵ Federal Baselines defined by Code of Federal Regulations §430.32(d). ENERGY STAR specification defined by Version 5.0 Room Air Conditioners, effective October 30, 2023. CEE specification defined by Room Air Conditioner Specification effective May 17, 2022.

Side louvers that extend from a room air conditioner model in order to position the unit in a window. A model without louvered sides is placed in a built-in wall sleeve and are commonly referred to as "through-the-wall" or "built-in" models.

Casement-only refers to a room air conditioner designed for mounting in a casement window of a specific size.

Casement-slider refers to a room air conditioner with an encased assembly designed for mounting in a sliding or casement window of a specific size. Reverse cycle refers to the heating function found in certain room air conditioner models.

DEFINITION OF EFFICIENT EQUIPMENT

To qualify for this measure the new room air conditioning unit must meet the ENERGY STAR efficiency standards presented above.

DEFINITION OF BASELINE EQUIPMENT

The baseline assumption is a new room air conditioning unit that meets the current minimum federal efficiency standards presented above.

DEEMED LIFETIME OF EFFICIENT EQUIPMENT

The measure life is assumed to be 12 years.⁶²⁶

DEEMED MEASURE COST

The incremental cost for this measure is assumed to be \$40 for an ENERGY STAR unit and \$261 for a CEE Tier 2 unit.⁶²⁷

LOADSHAPE

Loadshape C03 - Commercial Cooling

COINCIDENCE FACTOR

The summer peak coincidence factor for cooling is provided in two different ways below. The first is used to estimate peak savings during the utility peak hour and is most indicative of actual peak benefits, and the second represents the *average* savings over the defined summer peak period, and is presented so that savings can be bid into PJM’s capacity market. Both values provided are based on analysis of Itron eShape data for Missouri, calibrated to Illinois loads, supplied by Ameren.

- CF_{SSP} = Summer System Peak Coincidence Factor for Commercial cooling (during system peak hour)
= 91.3%⁶²⁸
- CF_{PJM} = PJM Summer Peak Coincidence Factor for Commercial cooling (average during peak period)
= 47.8%⁶²⁹

Algorithm

CALCULATION OF SAVINGS

ENERGY SAVINGS

$$\Delta kWh = (FLH_{RoomAC} * Btu/h * (1/CEER_{base} - 1/CEER_{ee}))/1000$$

Where:

- FLH_{RoomAC} = Full Load Hours of room air conditioning unit
= Equivalent Full Load Hours for cooling in Existing Buildings are provided in section 4.4 HVAC End Use

⁶²⁶ Measure Life Report, Residential and Commercial/Industrial Lighting and HVAC Measures, GDS Associates, June 2007.

⁶²⁷ ENERGY STAR cost based on field study conducted by Efficiency Vermont and Tier 2 based on Efficiency Vermont’s characterization of the NEEP Mid-Atlantic TRM’s (version 9.0, October 2019) incremental cost analysis. See ‘room-ac-cost-analysis-10.2023.xlsx.’

⁶²⁸ Based on analysis of Itron eShape data for Missouri, calibrated to Illinois loads, supplied by Ameren. The AC load during the utility’s peak hour is divided by the maximum AC load during the year.

⁶²⁹ Based on analysis of Itron eShape data for Missouri, calibrated to Illinois loads, supplied by Ameren. The average AC load over the PJM peak period (1-5pm, M-F, June through August) is divided by the maximum AC load during the year

Btu/h	= Input capacity of unit = Actual. If unknown assume 8,500 Btu/hr ⁶³⁰
CEER _{base}	= Combined Energy Efficiency Ratio of baseline unit = As provided in tables above
CEER _{ee}	= Combined Energy Efficiency Ratio of ENERGY STAR or CEE Super Efficient unit = Actual. If unknown assume minimum qualifying standard as provided in tables above

For example, for an 8,500 Btu/h capacity ENERGY STAR unit, with louvered sides, in an unknown location in Rockford:

$$\begin{aligned} \Delta kW_{\text{ENERGY STAR}} &= (1133 * 8500 * (1/10.9 - 1/14.7)) / 1000 \\ &= 228.4 \text{ kWh} \end{aligned}$$

SUMMER COINCIDENT PEAK DEMAND SAVINGS

$$\Delta kW = \text{Btu/h} * ((1/\text{CEER}_{\text{base}} - 1/\text{CEER}_{\text{ee}})/1000) * \text{CF}$$

Where:

CF_{SSP} = Summer System Peak Coincidence Factor for Commercial cooling (during system peak hour)
= 91.3% ⁶³¹

CF_{PJM} = PJM Summer Peak Coincidence Factor for Commercial cooling (average during peak period)
= 47.8% ⁶³²

Other variable as defined above

For example, for an 8,500 Btu/h capacity ENERGY STAR unit, with louvered sides, in Rockford during system peak:

$$\begin{aligned} \Delta kW_{\text{ENERGY STAR}} &= ((8500 * (1/10.9 - 1/14.7)) / 1000) * 0.913 \\ &= 0.184 \text{ kW} \end{aligned}$$

FOSSIL FUEL SAVINGS

N/A

WATER IMPACT DESCRIPTIONS AND CALCULATION

N/A

DEEMED O&M COST ADJUSTMENT CALCULATION

N/A

⁶³⁰ Based on maximum capacity average from the RLW Report: Final Report Coincidence Factor Study Residential Room Air Conditioners, June 23, 2008.

⁶³¹ Based on analysis of Itron eShape data for Missouri, calibrated to Illinois loads, supplied by Ameren. The AC load during the utility's peak hour is divided by the maximum AC load during the year.

⁶³² Based on analysis of Itron eShape data for Missouri, calibrated to Illinois loads, supplied by Ameren. The average AC load over the PJM peak period (1-5pm, M-F, June through August) is divided by the maximum AC load during the year.

MEASURE CODE: CI-HVC-ESRA-V04-240101

REVIEW DEADLINE: 1/1/2026

4.4.8 Guest Room Energy Management (PTAC & PTHP)

DESCRIPTION

This measure applied to the installation of a temperature setback and lighting control system for individual guest rooms. The savings are achieved based on Guest Room Energy Management's (GREM's) ability to automatically adjust the guest room's set temperatures and control the HVAC unit for various occupancy modes.

This measure was developed to be applicable to the following program types: TOS, NC. If applied to other program types, the measure savings should be verified.

DEFINITION OF EFFICIENT EQUIPMENT

Guest room temperature set point must be controlled by automatic occupancy detectors or keycard that indicates the occupancy status of the room. During unoccupied periods the default setting for controlled units differs by at least 5 degrees from the operating set point. Theoretically, the control system may also be tied into other electric loads, such as lighting and plug loads to shut them off when occupancy is not sensed. This measure bases savings on improved HVAC controls. If system is connected to lighting and plug loads, additional savings would be realized. The incentive is per guestroom controlled, rather than per sensor, for multi-room suites. Replacement or upgrades of existing occupancy-based controls are not eligible for an incentive.

DEFINITION OF BASELINE EQUIPMENT

Guest room energy management thermostats replace manual heating/cooling temperature set-point and fan On/Off/Auto thermostat controls. Two possible baselines exist based on whether housekeeping staff are directed to set-back (or turn off) thermostats when rooms are not rented.

DEEMED LIFETIME OF EFFICIENT EQUIPMENT

The measure life for GREM is 15 years.⁶³³

DEEMED MEASURE COST

\$260/unit.

The incremental cost documented for this measure is \$260 per room HVAC controller, which is the cost difference between a non-programmable thermostat and a GREM.⁶³⁴

DEEMED O&M COST ADJUSTMENTS

N/A

LOADSHAPE

Loadshape C03 - Commercial Cooling

COINCIDENCE FACTOR

A coincidence factor is not used in the determination of coincident peak kW savings.

Algorithm

CALCULATION OF SAVINGS

Below are the annual kWh savings per installed EMS for different sizes and types of HVAC units. The savings are achieved based on GREM's ability to automatically adjust the guest room's set temperatures and control the HVAC unit to maintain set temperatures for various occupancy modes. Note that care should be taken in selecting a value

⁶³³ DEER 2008 value for energy management systems.

⁶³⁴ This value was extracted from Smart Ideas projects in PY1 and PY2.

consistent with actual baseline conditions (e.g., whether housekeeping staff are directed to set-back/turn-off the thermostats when rooms are unrented). Different values are provided for Motels and Hotels since significant differences in shell performance, number of external walls per room and typical heating and cooling efficiencies result in significantly different savings estimates. Energy savings estimates are derived using a prototypical EnergyPlus simulation of a motel and a hotel.⁶³⁵ Model outputs are normalized to the installed capacity and reported here as kWh/Ton, coincident peak kW/Ton and Therms/Ton.

ELECTRIC ENERGY SAVINGS

Climate Zone (City based upon)	Heating Source	Baseline	Electric Savings (kWh/Ton)
Motel Electric Energy Savings			
1 (Rockford)	PTAC w/ Electric Resistance Heating	Housekeeping Setback	744
		No Housekeeping Setback	1,786
	PTAC w/ Gas Heating	Housekeeping Setback	63
		No Housekeeping Setback	155
	PTHP	Housekeeping Setback	385
		No Housekeeping Setback	986
2 (Chicago)	PTAC w/ Electric Resistance Heating	Housekeeping Setback	506
		No Housekeeping Setback	1,582
	PTAC w/ Gas Heating	Housekeeping Setback	51
		No Housekeeping Setback	163
	PTHP	Housekeeping Setback	211
		No Housekeeping Setback	798
3 (Springfield)	PTAC w/ Electric Resistance Heating	Housekeeping Setback	462
		No Housekeeping Setback	1,382
	PTAC w/ Gas Heating	Housekeeping Setback	65
		No Housekeeping Setback	198
	PTHP	Housekeeping Setback	202
		No Housekeeping Setback	736
4 (Belleville)	PTAC w/ Electric Resistance Heating	Housekeeping Setback	559
		No Housekeeping Setback	1,877
	PTAC w/ Gas Heating	Housekeeping Setback	85
		No Housekeeping Setback	287
	PTHP	Housekeeping Setback	260
		No Housekeeping Setback	1,023
5 (Marion-Williamson)	PTAC w/ Electric Resistance Heating	Housekeeping Setback	388
		No Housekeeping Setback	1,339
	PTAC w/ Gas Heating	Housekeeping Setback	81
		No Housekeeping Setback	274
	PTHP	Housekeeping Setback	174
		No Housekeeping Setback	682
Hotel Electric Energy Savings			
1 (Rockford)	PTAC w/ Electric Resistance Heating	Housekeeping Setback	204
		No Housekeeping Setback	345
	PTAC w/ Gas Heating	Housekeeping Setback	121

⁶³⁵ For motels, see S. Keates, ADM Associates Workpaper: “Suggested Revisions to Guest Room Energy Management (PTAC & PTHP)”, 11/14/2013 and spreadsheet summarizing the results: ‘GREM Savings Summary_IL TRM_1_22_14.xlsx’. In 2014 the hotel models were also run to compile results, rather than by applying adjustment factors to the motel results as had been done in V3.0 of the TRM. The updated values can be found in ‘GREM Savings Summary (Hotel)_IL TRM_10_16_14.xls’.

Climate Zone (City based upon)	Heating Source	Baseline	Electric Savings (kWh/Ton)
		No Housekeeping Setback	197
		Housekeeping Setback	152
	PTHP	No Housekeeping Setback	253
		Housekeeping Setback	177
	Central Hot Water Fan Coil w/ Electric Resistance Heating	No Housekeeping Setback	296
		Housekeeping Setback	94
Central Hot Water Fan Coil w/ Gas Heating	No Housekeeping Setback	148	
	Housekeeping Setback	188	
2 (Chicago)	PTAC w/ Electric Resistance Heating	No Housekeeping Setback	342
		Housekeeping Setback	119
	PTAC w/ Gas Heating	No Housekeeping Setback	195
		Housekeeping Setback	145
	PTHP	No Housekeeping Setback	250
		Housekeeping Setback	161
	Central Hot Water Fan Coil w/ Electric Resistance Heating	No Housekeeping Setback	294
		Housekeeping Setback	92
	Central Hot Water Fan Coil w/ Gas Heating	No Housekeeping Setback	147
		Housekeeping Setback	182
3 (Springfield)	PTAC w/ Electric Resistance Heating	No Housekeeping Setback	291
		Housekeeping Setback	123
	PTAC w/ Gas Heating	No Housekeeping Setback	197
		Housekeeping Setback	145
	PTHP	No Housekeeping Setback	233
		Housekeeping Setback	153
	Central Hot Water Fan Coil w/ Electric Resistance Heating	No Housekeeping Setback	240
		Housekeeping Setback	94
	Central Hot Water Fan Coil w/ Gas Heating	No Housekeeping Setback	146
		Housekeeping Setback	182
4 (Belleville)	PTAC w/ Electric Resistance Heating	No Housekeeping Setback	308
		Housekeeping Setback	125
	PTAC w/ Gas Heating	No Housekeeping Setback	199
		Housekeeping Setback	146
	PTHP	No Housekeeping Setback	240
		Housekeeping Setback	152
	Central Hot Water Fan Coil w/ Electric Resistance Heating	No Housekeeping Setback	255
		Housekeeping Setback	95
	Central Hot Water Fan Coil w/ Gas Heating	No Housekeeping Setback	147
		Housekeeping Setback	171
5 (Marion-Williamson)	PTAC w/ Electric Resistance Heating	No Housekeeping Setback	295
		Housekeeping Setback	122
	PTAC w/ Gas Heating	No Housekeeping Setback	199
		Housekeeping Setback	140
	PTHP	No Housekeeping Setback	235
		Housekeeping Setback	141
	Central Hot Water Fan Coil w/ Electric Resistance Heating	No Housekeeping Setback	243
		Housekeeping Setback	92
	Central Hot Water Fan Coil w/ Gas Heating	No Housekeeping Setback	146
		Housekeeping Setback	

SUMMER COINCIDENT PEAK DEMAND SAVINGS

Motel Coincident Peak Demand Savings			
Climate Zone (City based upon)	Heating Source	Baseline	Coincident Peak Demand Savings (kW/Ton)
1 (Rockford)	PTAC w/ Electric Resistance Heating	Housekeeping Setback	0.08
		No Housekeeping Setback	0.17
	PTAC w/ Gas Heating	Housekeeping Setback	0.08
		No Housekeeping Setback	0.17
	PTHP	Housekeeping Setback	0.08
		No Housekeeping Setback	0.17
2 (Chicago)	PTAC w/ Electric Resistance Heating	Housekeeping Setback	0.06
		No Housekeeping Setback	0.17
	PTAC w/ Gas Heating	Housekeeping Setback	0.06
		No Housekeeping Setback	0.17
	PTHP	Housekeeping Setback	0.06
		No Housekeeping Setback	0.17
3 (Springfield)	PTAC w/ Electric Resistance Heating	Housekeeping Setback	0.07
		No Housekeeping Setback	0.17
	PTAC w/ Gas Heating	Housekeeping Setback	0.07
		No Housekeeping Setback	0.17
	PTHP	Housekeeping Setback	0.07
		No Housekeeping Setback	0.17
4 (Belleville)	PTAC w/ Electric Resistance Heating	Housekeeping Setback	0.10
		No Housekeeping Setback	0.28
	PTAC w/ Gas Heating	Housekeeping Setback	0.10
		No Housekeeping Setback	0.28
	PTHP	Housekeeping Setback	0.10
		No Housekeeping Setback	0.28
5 (Marion-Williamson)	PTAC w/ Electric Resistance Heating	Housekeeping Setback	0.08
		No Housekeeping Setback	0.21
	PTAC w/ Gas Heating	Housekeeping Setback	0.08
		No Housekeeping Setback	0.21
	PTHP	Housekeeping Setback	0.08
		No Housekeeping Setback	0.21

Hotel Coincident Peak Demand Savings			
Climate Zone (City based upon)	Heating Source	Baseline	Coincident Peak Demand Savings (kW/Ton)
1 (Rockford)	PTAC w/ Electric Resistance Heating	Housekeeping Setback	0.08
		No Housekeeping Setback	0.11
	PTAC w/ Gas Heating	Housekeeping Setback	0.08
		No Housekeeping Setback	0.11
	PTHP	Housekeeping Setback	0.08
		No Housekeeping Setback	0.11
	Central Hot Water Fan Coil w/ Electric Resistance Heating	Housekeeping Setback	0.05
		No Housekeeping Setback	0.08

Hotel Coincident Peak Demand Savings			
Climate Zone (City based upon)	Heating Source	Baseline	Coincident Peak Demand Savings (kW/Ton)
	Central Hot Water Fan Coil w/ Gas Heating	Housekeeping Setback	0.05
		No Housekeeping Setback	0.08
2 (Chicago)	PTAC w/ Electric Resistance Heating	Housekeeping Setback	0.07
		No Housekeeping Setback	0.11
	PTAC w/ Gas Heating	Housekeeping Setback	0.07
		No Housekeeping Setback	0.11
	PTHP	Housekeeping Setback	0.07
		No Housekeeping Setback	0.11
	Central Hot Water Fan Coil w/ Electric Resistance Heating	Housekeeping Setback	0.05
		No Housekeeping Setback	0.07
Central Hot Water Fan Coil w/ Gas Heating	Housekeeping Setback	0.05	
	No Housekeeping Setback	0.07	
3 (Springfield)	PTAC w/ Electric Resistance Heating	Housekeeping Setback	0.08
		No Housekeeping Setback	0.11
	PTAC w/ Gas Heating	Housekeeping Setback	0.08
		No Housekeeping Setback	0.11
	PTHP	Housekeeping Setback	0.08
		No Housekeeping Setback	0.11
	Central Hot Water Fan Coil w/ Electric Resistance Heating	Housekeeping Setback	0.05
		No Housekeeping Setback	0.07
Central Hot Water Fan Coil w/ Gas Heating	Housekeeping Setback	0.05	
	No Housekeeping Setback	0.07	
4 (Belleville)	PTAC w/ Electric Resistance Heating	Housekeeping Setback	0.08
		No Housekeeping Setback	0.11
	PTAC w/ Gas Heating	Housekeeping Setback	0.08
		No Housekeeping Setback	0.11
	PTHP	Housekeeping Setback	0.08
		No Housekeeping Setback	0.11
	Central Hot Water Fan Coil w/ Electric Resistance Heating	Housekeeping Setback	0.05
		No Housekeeping Setback	0.08
Central Hot Water Fan Coil w/ Gas Heating	Housekeeping Setback	0.05	
	No Housekeeping Setback	0.08	
5 (Marion-Williamson)	PTAC w/ Electric Resistance Heating	Housekeeping Setback	0.08
		No Housekeeping Setback	0.11
	PTAC w/ Gas Heating	Housekeeping Setback	0.08
		No Housekeeping Setback	0.11
	PTHP	Housekeeping Setback	0.08
		No Housekeeping Setback	0.11
	Central Hot Water Fan Coil w/ Electric Resistance Heating	Housekeeping Setback	0.05
		No Housekeeping Setback	0.08
Central Hot Water Fan Coil w/ Gas Heating	Housekeeping Setback	0.05	
	No Housekeeping Setback	0.08	

FOSSIL FUEL SAVINGS

For PTACs with gas heating:

Motel Natural Gas Energy Savings			
Climate Zone (City based upon)	Baseline	Gas Savings (Therms/Ton)	
1 (Rockford)	Housekeeping Setback	30	
	No Housekeeping Setback	71	
2 (Chicago)	Housekeeping Setback	20	
	No Housekeeping Setback	62	
3 (Springfield)	Housekeeping Setback	17	
	No Housekeeping Setback	52	
4 (Belleville)	Housekeeping Setback	21	
	No Housekeeping Setback	70	
5 (Marion-Williamson)	Housekeeping Setback	13	
	No Housekeeping Setback	47	

Hotel Natural Gas Energy Savings			
Climate Zone (City based upon)	Heating Source	Baseline	Gas Savings (Therms/Ton)
1 (Rockford)	PTAC w/ Gas Heating	Housekeeping Setback	3.6
		No Housekeeping Setback	6.4
	Central Hot Water Fan Coil w/ Gas Heating	Housekeeping Setback	3.6
		No Housekeeping Setback	6.4
2 (Chicago)	PTAC w/ Gas Heating	Housekeeping Setback	3.0
		No Housekeeping Setback	6.5
	Central Hot Water Fan Coil w/ Gas Heating	Housekeeping Setback	3.0
		No Housekeeping Setback	6.5
3 (Springfield)	PTAC w/ Gas Heating	Housekeeping Setback	2.6
		No Housekeeping Setback	4.1
	Central Hot Water Fan Coil w/ Gas Heating	Housekeeping Setback	2.6
		No Housekeeping Setback	4.1
4 (Belleville)	PTAC w/ Gas Heating	Housekeeping Setback	2.5
		No Housekeeping Setback	4.8
	Central Hot Water Fan Coil w/ Gas Heating	Housekeeping Setback	2.5
		No Housekeeping Setback	4.8
5 (Marion-Williamson)	PTAC w/ Gas Heating	Housekeeping Setback	2.1
		No Housekeeping Setback	4.2
	Central Hot Water Fan Coil w/ Gas Heating	Housekeeping Setback	2.1
		No Housekeeping Setback	4.2

WATER IMPACT DESCRIPTIONS AND CALCULATION

N/A

DEEMED O&M COST ADJUSTMENT CALCULATION

N/A

MEASURE CODE: CI-HVC-GREM-V06-0601

REVIEW DEADLINE: 1/1/2026

4.4.9 Air and Water Source Heat Pump Systems (Centrally Ducted and Ductless)

DESCRIPTION

This measure applies to the installation of high-efficiency air cooled and water source heat pump systems with conditioned air delivered to the building via ductwork, ductless systems and “hybrid” systems that work in conjunction with fuel-fired heating systems. This measure could apply to replacing an existing unit at the end of its useful life, or installation of a new unit in a new or existing building.

This measure was developed to be applicable to the following program types: TOS, NC, EREP. If applied to other program types, the measure savings should be verified.

DEFINITION OF EFFICIENT EQUIPMENT

In order for this characterization to apply, the efficient equipment is assumed to be a high-efficiency air cooled or water source, heat pump system that exceeds the baseline and meets program requirements.

DEFINITION OF BASELINE EQUIPMENT

New construction / Time of Sale: To calculate savings with an electric baseline, the baseline equipment is assumed to be a standard-efficiency air cooled or water source heat pump system that meets the Code energy efficiency requirements (IECC or Code of Federal Regulations whichever is higher) in effect on the date of equipment purchase (if date unknown assume current Code minimum). The rating conditions for the baseline and efficient equipment efficiencies must be equivalent.

To calculate savings with a furnace/ AC baseline, the baseline equipment is assumed to meet the Code energy efficiency requirements (IECC or Code of Federal Regulations whichever is higher).

Where unknown, the baseline should be determined via EM&V and the algorithms are provided to allow savings to be calculated from any baseline condition.

In order for this characterization to apply, the baseline equipment is assumed to meet the efficiency requirements within the IECC code in effect on the date of the building permit. As code requirements and adoption can differ from municipality to municipality, the user should verify which version of code is applicable given these constraints.

Note, IECC 2021 is became effective statewide on 1/1/2024. IECC 2018 is the requisite code for any projects with permitting dates spanning July 1, 2019 to 12/31/2023. Prior to July 1, 2019, IECC 2015 is the applicable code. If evaluation determines the applicable version of code, given location and timing, isn't an appropriate baseline due to supply constraints, low compliance, or other issues, the previous iteration of code may be used through 2023.

IECC 2021 leverages new DOE testing methods and associated metrics. The following conversion factors are recommended for use if the efficient equipment is not rated under the new testing procedure but the stipulated baseline is:⁶³⁶

$$\text{SEER2} = X * \text{SEER}$$

$$\text{EER2} = X * \text{EER}$$

$$\text{HSPF2} = X * \text{HSPF}$$

Where:

X	SEER2	EER2	HSPF2
Ducted	0.95	0.95	0.85
Ductless	1.00	1.00	0.90
Packaged	0.95	0.95	0.84

⁶³⁶ Consortium for Energy Efficiency (CEE), Testing, Testing, M1, 2, 3, Transitioning to New Federal Minimum Standards, CEE Summer Program Meeting, August, 2022.

Note: new Federal Standards affecting heat pumps and air conditioning equipment became effective January 1, 2023.

Early replacement / Retrofit: The baseline for this measure is the efficiency of the *existing* heating and cooling equipment for the assumed remaining useful life of the existing unit and a new baseline heating and cooling system meeting the code energy efficiency requirements (IECC or Code of Federal Regulations whichever is higher) for the remainder of the measure life.

A weighted average early replacement rate is provided for use in programs when the actual baseline early replacement rates are unknown.

Deemed Early Replacement Rates For ASHP⁶³⁷

Equipment Type	Full System Displacement	Partial System Displacement
Cooling	30%	30%
Heating	30%	100%

Note to apply these deemed early replacement rates, an assumption of the percentage of replacements that are full displacement v partial displacement is required. This should be determined through evaluation, or a deemed ratio of 100% Full Displacement for ducted ASHPs and 50% Full: 50% Partial for Ductless ASHPs can be used. Savings should be calculated following both the full and partial displacement methodology and then this ratio should be used to weight the savings accordingly.

DEEMED LIFETIME OF EFFICIENT EQUIPMENT

The expected measure life is assumed to be 16 years.⁶³⁸

Remaining life of existing equipment is assumed to be 6 years for ASHP and Central AC, 6 years for furnace, 8 years for boilers⁶³⁹ and 16 years for electric resistance.⁶⁴⁰

DEEMED MEASURE COST

Ducted Air Source Heat Pumps:

New Construction and Time of Sale: For analysis purposes, the incremental capital cost for this measure is assumed as \$100 per ton for air-cooled units.⁶⁴¹ The incremental cost for all other equipment types should be determined on a site-specific basis.

⁶³⁷ Consistent with Residential assumptions – should be updated with Commercial data when available. Program tracking data from ComEd and Ameren between 2018 and 2020 was used to develop these assumptions. During this period the air source heat pump programs operated downstream and projects were classified as Time of Sale or Early Replacement. Note that any fuel switch scenario at the time would have been classified as Time of Sale and therefore the rates provided likely represent a low estimate of the true early replacement rates. In the absence of alternative data, the TAC agreed to apply these rates and the deemed full v partial displacement assumptions listed, but these assumptions should be revisited through future evaluation.

⁶³⁸ Consistent with Residential measure and based on 2016 DOE Rulemaking Technical Support document, as recommended in Guidehouse 'ComEd Effective Useful Life Research Report', May 2018.

⁶³⁹ Assumed to be one third of effective useful life of replaced equipment.

⁶⁴⁰ Assume full measure life (16 years) for replacing electric resistance as we would not expect that resistance heat would fail during the lifetime of the efficient measure.

⁶⁴¹ Based on a review of TRM incremental cost assumptions from Vermont, Wisconsin, and California.

Early Replacement: The actual full installation cost of the Heat Pump (including any necessary electrical or distribution upgrades required) should be used. The assumed deferred cost of replacing existing equipment with a new baseline unit should also be incorporated.

Ductless Minisplit Heat Pumps:

New Construction and Time of Sale: The actual installed cost of the DMSHP (including any necessary electrical or distribution upgrades required) should be used (defaults are provided below), minus the assumed installation cost of the baseline equipment (\$6,562 + \$600 per ton for ASHP,⁶⁴² or \$2,011 for a new baseline 80% AFUE furnace, or \$4,053 for a new 84% AFUE boiler,⁶⁴³ and \$952 per ton for new baseline Central AC replacement ⁶⁴⁴).

Default full cost of the DMSHP is provided below. Note, for smaller units a minimum cost of \$2,000 should be applied.⁶⁴⁵

Unit Size	Full Install Cost (\$/ton) ⁶⁴⁶
9-9.9	\$1,443
10-10.9	\$1,605
11-12.9	\$1,715
13+	\$2,041

The incremental cost of the DSMHP compared to a baseline minimum efficiency DSMHP is provided in the table below:⁶⁴⁷

Efficiency (HSPF2)	Incremental Cost (\$/ton) over an HSPF2 7.5 DHP
8.1-8.9	\$62
9-9.8	\$224
9.9-11.6	\$334
11.7+	\$660

Early Replacement/retrofit (replacing existing equipment): The actual full installation cost of the DMSHP (including any necessary electrical or distribution upgrades required) should be used. The assumed deferred cost (after 8 years) of replacing existing equipment with a new baseline unit is assumed to be \$7,527 + \$688 per ton for a new baseline Air Source Heat Pump, or \$2,296 for a new baseline 80% AFUE furnace or \$4,627 for a new 84% AFUE boiler and \$1,047 per ton for new baseline Central AC replacement.⁶⁴⁸ If replacing electric resistance heat, there is no deferred replacement cost. This future cost should be discounted to present value using the nominal societal discount rate.

Where the DMSHP is a supplemental HVAC system, the full installation cost of the DMSHP (including any necessary electrical or distribution upgrades required) should be used without a deferred replacement cost.

⁶⁴² Full install ASHP costs are based upon data provided by Ameren. See 'ASHP Costs_06242022'.

⁶⁴³ Furnace and boiler costs are based on data provided in Appendix E of the Appliance Standards Technical Support Documents including equipment cost and installation labor. Where efficiency ratings are not provided, the values are interpolated from those that are.

⁶⁴⁴ Based on 3 ton initial cost estimate for a conventional unit from ENERGY STAR Central AC calculator

⁶⁴⁵ The cost per ton table provides reasonable estimates for installation costs of DMSHP, which can vary significantly due to requirements of the home. It is estimated that all units, even those 1 ton or less will be at least \$2000 to install.

⁶⁴⁶ Full costs based upon full install cost of an ASHP plus incremental costs provided in Memo from Opinion Dynamics Evaluation Team, Ductless Mini-Split Heat Pumps: Incremental Cost Analysis, April 27, 2017.

⁶⁴⁷ Memo from Opinion Dynamics Evaluation Team, Ductless Mini-Split Heat Pumps: Incremental Cost Analysis, April 27, 2017

⁶⁴⁸ All baseline replacement costs are consistent with their respective measures and include inflation rate of 1.91%.

If the install cost is unknown a default is provided above. Fuel switch scenarios are likely to require additional installation work which may include adding new electrical circuits, capping existing gas lines and upgrading electrical panels. These costs are likely to range significantly and actual values should be used wherever possible. If unknown, assume an additional \$300 for fuel switch installations.

LOADSHAPE

Loadshape C05 - Commercial Electric Heating and Cooling

COINCIDENCE FACTOR

The summer peak coincidence factor for cooling is provided in two different ways below. The first is used to estimate peak savings during the utility peak hour and is most indicative of actual peak benefits, and the second represents the *average* savings over the defined summer peak period, and is presented so that savings can be bid into PJM’s capacity market. Both values provided are based on analysis of Itron eShape data for Missouri, calibrated to Illinois loads, supplied by Ameren.

$$CF_{SSP} = \text{Summer System Peak Coincidence Factor for Commercial cooling (during system peak hour)}$$

$$= 91.3\%^{649}$$

$$CF_{PJM} = \text{PJM Summer Peak Coincidence Factor for Commercial cooling (average during peak period)}$$

$$= 47.8\%^{650}$$

Algorithm

CALCULATION OF SAVINGS

ELECTRIC AND FOSSIL FUEL ENERGY SAVINGS

Non fuel switch measures:

$$\Delta kWh_{\text{Non Fuel Switch}} = \text{ASHPSiteCoolingImpact} + \text{ASHPSiteHeatingImpact}$$

Where:

For units with cooling capacities less than 65 kBtu/hr (ASHP only):

$$\text{ASHPSiteCoolingImpact} = ((\text{CoolingLoad}/\text{DuctlessSave} * (1/(\text{SEER2_base}))) - (\text{CoolingLoad} * 1/(\text{SEER2_ee})))/1,000$$

$$\text{ASHPSiteHeatingImpact} = ((\text{HeatLoad_Disp}/\text{DuctlessSave} * (1/(\text{HSPF2_base} * \text{HSPF2_ClimateAdj}))) - (\text{HeatLoad_Disp} * 1/(\text{HSPF2_ee} * \text{HSPF2_ClimateAdj}))) / 1,000$$

For ASHP units with cooling capacities equal to or greater than 65 kBtu/hr and all WSHPs:

$$\Delta kWh_{\text{Non Fuel Switch}} = \text{ASHPSiteCoolingImpact} + \text{ASHPSiteHeatingImpact}$$

Where:

$$\text{ASHPSiteCoolingImpact} = ((\text{CoolingLoad} * (1/(\text{IEER_base}))) - (\text{CoolingLoad} * 1/(\text{IEER_ee})))/1,000$$

⁶⁴⁹ Based on analysis of Itron eShape data for Missouri, calibrated to Illinois loads, supplied by Ameren. The AC load during the utility’s peak hour is divided by the maximum AC load during the year.

⁶⁵⁰ Based on analysis of Itron eShape data for Missouri, calibrated to Illinois loads, supplied by Ameren. The average AC load over the PJM peak period (1-5pm, M-F, June through August) is divided by the maximum AC load during the year.

$$\text{ASHPSiteHeatingImpact} = ((\text{HeatLoad_Disp} / 3,412 * (1/\text{COP_base})) - (\text{HeatLoad_Disp} * 1/\text{COP_ee})) / 1000$$

Fuel switch measures:

Fuel switch measures must produce positive total lifecycle energy savings (i.e., reduction in Btus at the premises) in order to qualify. This is determined as follows (note for early replacement measures the lifetime savings should be calculated by calculating savings for the remaining useful life of the existing equipment and for the remaining measure life):

$$\text{SiteEnergySavings (MMBTUs)} = \text{FuelSwitchSavings} + \text{NonFuelSwitchSavings}$$

$$\text{FuelSwitchSavings} = \text{GasHeatReplaced} - \text{HPSiteHeatConsumed}$$

$$\text{NonFuelSwitchSavings} = \text{FurnaceFanSavings} + \text{HPSiteCoolingImpact}$$

For units with cooling capacities less than 65 kBtu/hr (ASHP only):

$$\text{ASHPSiteHeatConsumed} = ((\text{HeatLoad_Disp} * (1/(\text{HSPF2_ee} * \text{HSPF2_ClimateAdj} * \text{PD_Adj}))) / 1,000 * 3,412) / 1,000,000$$

$$\text{ASHPSiteCoolingImpact} = (((\text{CoolingLoad}/\text{DuctlessSave} * (1/(\text{SEER2_base})) - ((\text{CoolingLoad} * 1/(\text{SEER2_ee}))))/1,000 * 3412) / 1,000,000$$

$$\text{FurnaceFanSavings} = (\text{FurnaceFlag} * \text{HeatLoad_Disp}/\text{DuctlessSave} * 1/\text{AFUE}_{\text{base}} * F_e) / 1,000,000$$

$$\text{GasHeatReplaced} = (\text{HeatLoad_Disp}/\text{DuctlessSave} * 1/\text{AFUE}_{\text{base}}) / 1,000,000$$

For ASHP units with cooling capacities greater than 65 kBtu/hr and all WSHPs:

$$\text{ASHPSiteHeatConsumed} = ((\text{HeatLoad_Disp} * (1/(\text{COP_ee} * \text{PD_Adj}))) / 1000 * 3,412) / 1,000,000$$

$$\text{ASHPSiteCoolingImpact} = (((\text{CoolingLoad} * (1/(\text{IEER_base})) - ((\text{CoolingLoad} * 1/(\text{IEER_ee}))))/1,000 * 3,412) / 1,000,000$$

$$\text{FurnaceFanSavings} = (\text{FurnaceFlag} * \text{HeatLoad_Disp} * 1/\text{AFUE}_{\text{base}} * F_e) / 1,000,000$$

$$\text{GasHeatReplaced} = (\text{HeatLoad_Disp} * 1/\text{AFUE}_{\text{base}}) / 1,000,000$$

If SiteEnergySavings calculated above is positive, the measure is eligible.

The appropriate savings claim is dependent on which utilities are supporting the measure as provided in a table below:

Measure supported by:	Electric Utility claims (kWh):	Gas Utility claims (therms):
Electric utility only	SiteEnergySavings * 1,000,000/3,412	N/A
Electric and gas utility (Note utilities may make alternative agreements to how savings are	%IncentiveElectric * SiteEnergySavings * 1,000,000/3,412	%IncentiveGas * SiteEnergySavings * 10

Measure supported by:	Electric Utility claims (kWh):	Gas Utility claims (therms):
allocated as long as total MMBtu savings remains the same).		
Gas utility only	N/A	SiteEnergySavings * 10

Note for Early Replacement measures, the efficiency terms of the existing unit should be used for the remaining useful life of the existing equipment (6 years for ASHP and Central AC, 6 years for furnace, 8 years for boilers, 15 years for electric resistance), and the efficiency terms for a new baseline unit should be used for the remaining years of the measure. See assumptions below.

Programs where existing system unknown

In programs where the existing fuel or system type is unknown, savings should be apportioned between the Fuel Switch and Non- Fuel Switch scenarios, as follows:

$$\text{Savings from Non-Fuel Switch (kWh)} = (1 - \%FuelSwitch) * \Delta kWh_{\text{Non Fuel Switch}}$$

Plus

$$\begin{aligned} \text{Savings from Fuel Switch (MMBtu converted to appropriate fuel as table above)} \\ = \%FuelSwitch * \text{SiteEnergySavings (MMBTUs)} \end{aligned}$$

Where:

- $\%FuelSwitch$ = The percentage of replacements resulting in fuel-switching.
 = 1 when fuel switching is known, 0 if non fuel switch
 = when unknown, e.g. midstream program, determine via evaluation
- $CoolingLoad$ = Annual cooling load for the building
 = $EFLH_{cool} * Capacity_{cool}$
- $Capacity_{cool}$ = Output capacity of the cooling equipment in Btu per hour (1 ton of cooling capacity equals 12,000 Btu/hr).
 = Actual installed
- $SEER2_{base}$ = Seasonal Energy Efficiency Ratio of the baseline equipment
 = SEER from tables below, based on the applicable Code on the date of equipment purchase (if unknown assume current Code).
- $SEER2_{ee}$ = Seasonal Energy Efficiency Ratio of the energy efficient equipment.
 = Actual installed
- $EFLH_{cool}$ = Equivalent Full Load Hours for cooling in Existing Buildings or New Construction are provided in section 4.4 HVAC End Use.
- $DuctlessSave$ = Factor used to adjust ducted heating or cooling load displaced by ductless systems that are not subject to losses from existing ductwork.
 = $1 - 0.15 = 0.85$ for ducted system displaced by ductless system
 = 1.00 for ducted system displaced by ducted system or ductless system displaced by ductless system
- $HSPF2_{base}$ = Heating Seasonal Performance Factor of the baseline equipment

= HSPF from tables below, based on the applicable Code on the date of equipment purchase (if unknown assume a blended baseline value of 5.1 HSPF2⁶⁵¹).

HSPF_{2ee} = Heating Seasonal Performance Factor of the energy efficient equipment.

= Actual installed. If rating is COP, HSPF = COP * 3.413

HSPF_ClimateAdj = Adjustment factor to account for observed discrepancy between seasonal heating performance relative to rated HSPF as provided by standard AHRI 210/240 rating conditions. Note, the adjustment is dependent on the test method use for the rating (i.e. HSPF or HSPF2 rating)⁶⁵²:

City (county based upon)	HSPF_ClimateAdj When using HSPF2 rating
1 (Rockford)	77%
2 (Chicago)	77%
3 (Springfield)	91%
4 (Belleville)	91%
5 (Marion)	91%
Weighted Average ⁶⁵³	
ComEd	77%
Ameren	89%
Statewide	80%

IEER_{base} = Integrated Energy Efficiency Ratio of the baseline equipment

= IEER (or EER2) from tables below, based on the applicable Code on the date of equipment purchase (if unknown assume current Code). For air-cooled units < 65 kBtu/hr, assume the following conversion from SEER2 to EER2 for calculation of peak savings:⁶⁵⁴

$$EER2 = (-0.02 * SEER2^2) + (1.12 * SEER2)$$

IEER_{ee} = Integrated Energy Efficiency Ratio (or EER2) of the energy efficient equipment. For air-cooled units < 65 kBtu/hr, if the actual EER2_{ee} is unknown, assume the conversion from SEER2 to EER2 as provided above.

= Actual installed

HeatLoad_Displ = Annual heat load for the building displaced by the ASHP (Btus)

= EFLH_{heat} * Capacity_{heat} * HeatLoadFactor

⁶⁵¹ Blended Baseline value came from percentage of accounts with heat pumps (40.17%) at 7.5 HSPF2 and electric furnaces (59.83%) at 3.41 HSPF as reported in the ComEd Baseline Study August 14, 2020.

⁶⁵² Adjustment factors are based on findings from NEEA, July 2020 'EXP07:19 Load-based and Climate-Specific Testing and Rating Procedures for Heat Pumps and Air Conditioners'. See 'NEEA HP data' for calculation. Findings were consistent with other reviewed sources including ASHRAE, 2020 'Right-Sizing Electric Heat Pump and Auxiliary Heating for Residential Heating Systems Based on Actual Performance Associated with Climate Zone' and Cadmus, 2022 'Residential ccASHP Building Electrification Study'. The difference between HSPF and HSPF2 ratings is based on the change in testing procedure that will correct for some of this effect where ducted systems will have an approximately 9% lower HSPF2 rating as compared to HSPF, based on CEE presentation, July 2022, 'Testing Testing, M1, 2, 3: Transitioning to New Federal Minimum Standards'.

⁶⁵³ Weighting for Ameren is based on electric heat accounts in each of the heating zones. Weighting for ComEd and Statewide average is based on number of occupied residential housing units in each zone. ComEd is weighted average of Zones 1-2. Alternative program-weighted assumptions can be used if appropriate.

⁶⁵⁴ Based on Wassmer, M. (2003). A Component-Based Model for Residential Air Conditioner and Heat Pump Energy Calculations. Masters Thesis, University of Colorado at Boulder. Note this is appropriate for single speed units only.

$EFLH_{heat}$ = heating mode equivalent full load hours in Existing Buildings or New Construction are provided in section 4.4 HVAC End Use.

$Capacity_{heat}$ = output capacity of the heat pump equipment in Btu per hour.
= Actual installed

$HeatLoadFactor$ = Portion of HeatLoad displaced by ASHP in partial displacement applications. Varies by Switchover Temperature and Climate Region. If Switchover Temperature is unknown, use 32°F.
= 1.0 if full displacement (e.g. cold climate heat pumps and water source heat pumps) or if switchover temperature is lower than 17°F or if Partial Displacement with simultaneous operation

Climate Zone (City based upon)	HeatLoadFactor (by Switchover Temperature) ⁶⁵⁵										
	47°F	44°F	41°F	38°F	35°F	32°F	29°F	26°F	23°F	20°F	17°F
1 (Rockford)	4%	8%	12%	16%	26%	36%	45%	58%	66%	71%	78%
2 (Chicago)	4%	9%	15%	21%	32%	43%	52%	66%	74%	77%	84%
3 (Springfield)	4%	9%	15%	21%	37%	52%	59%	69%	76%	79%	85%
4 (Belleville)	7%	14%	22%	30%	41%	55%	66%	77%	85%	90%	93%
5 (Marion)	7%	16%	25%	34%	53%	67%	76%	86%	90%	93%	97%
Weighted Average ⁶⁵⁶											
ComEd	4%	9%	15%	20%	31%	43%	51%	66%	73%	77%	84%
Ameren	5%	11%	17%	24%	38%	52%	60%	71%	79%	82%	88%
Statewide	4%	9%	16%	21%	33%	45%	54%	67%	75%	79%	85%

PD_Adj = Adjustment multiplier to account for increased heat pump efficiency in Partial Displacement applications when there is no electric resistance backup and switchover temperature is higher than 17F. Varies by Switchover Temperature and Climate Region. If Switchover Temperature is unknown, use 32F.
= 1.0 if full displacement (e.g. cold climate heat pumps or water source heat pumps) or if switchover temperature is lower than 17F or if Partial Displacement with simultaneous operation

Climate Zone (City based upon)	PD_Adj (by Switchover Temperature) ⁶⁵⁷										
	47°F	44°F	41°F	38°F	35°F	32°F	29°F	26°F	23°F	20°F	17°F
1 (Rockford)	153%	149%	146%	143%	138%	134%	132%	128%	126%	124%	122%

⁶⁵⁵ Values based on Morehead Energy 2024 analysis of TMYx typical hourly weather data for 2007-2021. See 'ASHP Partial Displacement Analysis 20240611_HDD55.xlsx'.

⁶⁵⁶ Weighting for Ameren is based on electric heat accounts in each of the heating zones. Weighting for ComEd and Statewide average is based on number of occupied residential housing units in each zone. ComEd is weighted average of Zones 1-2. Alternative program-weighted assumptions can be used if appropriate.

⁶⁵⁷ Values based on Morehead Energy 2024 analysis of TMYx typical hourly weather data for 2007-2021. See 'ASHP Partial Displacement Analysis 20240611_HDD55.xlsx'.

Climate Zone (City based upon)	PD_Adj (by Switchover Temperature) ⁶⁵⁷										
	47°F	44°F	41°F	38°F	35°F	32°F	29°F	26°F	23°F	20°F	17°F
2 (Chicago)	153%	148%	145%	142%	138%	134%	132%	128%	126%	125%	123%
3 (Springfield)	153%	148%	145%	142%	137%	133%	132%	129%	128%	127%	125%
4 (Belleville)	152%	149%	145%	143%	139%	135%	133%	131%	128%	127%	126%
5 (Marion)	153%	148%	145%	142%	138%	135%	134%	131%	130%	129%	128%
Weighted Average ⁶⁵⁸											
ComEd	153%	148%	145%	142%	138%	134%	132%	128%	126%	125%	123%
Ameren	153%	148%	145%	142%	138%	134%	132%	130%	128%	127%	125%
Statewide	153%	148%	145%	142%	138%	134%	132%	129%	127%	126%	124%

3412 = Btu per kWh.

COP_{base} = coefficient of performance of the baseline equipment
 = COP from tables below, based on the applicable Code on the date of equipment purchase (if unknown assume current Code). If rating is HSPF2, COP = HSPF2 / 3.413

COP_{ee} = coefficient of performance of the energy efficient equipment.
 = Actual installed. If rating is HSPF2, COP = HSPF2 / 3.413

AFUE_{base} = Baseline Annual Fuel Utilization Efficiency Rating. For early replacement measures, use actual AFUE rating for the remaining useful life of the existing equipment (6 years for furnace, 8 years for boilers). For new systems (time of sale, new construction or remaining years of early replacement), use appropriate code level efficiency.

FurnaceFlag = 1 if system replaced is a gas furnace, 0 if not.

F_e = Furnace Fan energy consumption as a percentage of annual fuel consumption
 = 7.7%⁶⁵⁹

%IncentiveElectric = % of total incentive paid by electric utility
 = Actual

%IncentiveGas = % of total incentive paid by gas utility
 = Actual

Code of Federal Regulations (baseline effective 1/1/2019):⁶⁶⁰

⁶⁵⁸ Weighting for Ameren is based on electric heat accounts in each of the heating zones. Weighting for ComEd and Statewide average is based on number of occupied residential housing units in each zone. ComEd is weighted average of Zones 1-2. Alternative program-weighted assumptions can be used if appropriate.

⁶⁵⁹ F_e is estimated using TRM models for the three most popular building types for programmable thermostats: low-rise office (10.2%), sit-down restaurant (8.6%), and retail – strip mall (4.4%). 7.7% reflects the average F_e of the three building types. See “Fan Energy Factor Example Calculation 2021-06-23.xlsx” for reference.

⁶⁶⁰ Code of Federal Regulations: Table 3 to §431.97—Updates to the Minimum Cooling Efficiency Standards for Air Conditioning and Heating Equipment and Table 4 to §431.97—Updates to the Minimum Heating Efficiency Standards for Air-Cooled Air

Equipment type	Cooling capacity	Heating type	Cooling Efficiency level	Heating Efficiency level	Compliance date
Small Commercial Packaged Air Conditioning and Heating Equipment (Air-Cooled)	≥65,000 Btu/h and <135,000 Btu/h	Electric Resistance Heating or No Heating	IEER = 12.2 IEER = 14.1	N/A	1/1/2018 1/1/2024
		All Other Types of Heating	IEER = 12.0 IEER = 13.9	COP = 3.3 COP = 3.4	1/1/2018 1/1/2024
Large Commercial Packaged Air Conditioning and Heating Equipment (Air-Cooled)	≥135,000 Btu/h and <240,000 Btu/h	Electric Resistance Heating or No Heating	IEER = 11.6 IEER = 13.5	N/A	1/1/2018 1/1/2024
		All Other Types of Heating	IEER = 11.4 IEER = 13.3	COP = 3.2 COP = 3.3	1/1/2018 1/1/2024
Very Large Commercial Packaged Air Conditioning and Heating Equipment (Air-Cooled)	≥240,000 Btu/h and <760,000 Btu/h	Electric Resistance Heating or No Heating	IEER = 10.6 IEER = 12.5	N/A	1/1/2018 1/1/2024
		All Other Types of Heating	IEER = 10.4 IEER = 12.3	COP = 3.2	1/1/2018 1/1/2024
Small Commercial Package Air-Conditioning and Heating Equipment (Air-Cooled, Single-Phase, Split-System)	<65,000 Btu/h	All	SEER2 = 14.3 EER2 = 9.4	HSPF2 = 7.5	1/1/2023
Small Commercial Package Air-Conditioning and Heating Equipment (Air-Cooled, Single-Phase, Single-Package)	<65,000Btu/h	All	SEER2 = 13.4 EER2 = 8.8	HSPF2 = 6.7	1/1/2023
Small Commercial Package Air-Conditioning and Heating Equipment (Air-Cooled, 3-Phase, Split-System)	<65,000 Btu/h	All	SEER2 = 14.3 EER2 = 9.4	HSPF2 = 7.5	1/1/2025
Small Commercial Package Air-Conditioning and Heating Equipment (Air-Cooled, 3-Phase, Single-Package)	<65,000Btu/h	All	SEER2 = 13.4 EER2 = 8.8	HSPF2 = 6.7	1/1/2025
Small Commercial Packaged Air-Conditioning and Heating Equipment (Water Source: Water-to-Air, Water-Loop)	<17,000 Btu/h	All	EER = 12.2	COP = 4.3	10/9/2015
	≥17,000 Btu/h and <65,000 Btu/h	All	EER = 13.0	COP = 4.3	10/9/2015
	≥65,000 Btu/h and <135,000Btu/h	All	EER = 13.0	COP = 4.3	10/9/2015

Conditioning and Heating Equipment [Heat Pumps]. For 1/1/2024 compliance dates, note these manufacturing and import federal standards go into effect on 1/1/2023. The measure characterization is recommending delaying adopting these standards until 1/1/2024.

Minimum Efficiency Requirements: 2015 IECC (baseline effective 1/1/2016 to 6/30/2019)

TABLE C403.2.3(2)
**MINIMUM EFFICIENCY REQUIREMENTS:
 ELECTRICALLY OPERATED UNITARY AND APPLIED HEAT PUMPS**

EQUIPMENT TYPE	SIZE CATEGORY	HEATING SECTION TYPE	SUBCATEGORY OR RATING CONDITION	MINIMUM EFFICIENCY		TEST PROCEDURE ^a	
				Before 1/1/2016	As of 1/1/2016		
Air cooled (cooling mode)	< 65,000 Btu/h ^b	All	Split System	13.0 SEER ^c	14.0 SEER ^c	AHRI 210/240	
			Single Package	13.0 SEER ^c	14.0 SEER ^c		
Through-the-wall, air cooled	≤ 30,000 Btu/h ^b	All	Split System	12.0 SEER	12.0 SEER		
			Single Package	12.0 SEER	12.0 SEER		
Single-duct high-velocity air cooled	< 65,000 Btu/h ^b	All	Split System	11.0 SEER	11.0 SEER		
Air cooled (cooling mode)	≥ 65,000 Btu/h and < 135,000 Btu/h	Electric Resistance (or None)	Split System and Single Package	11.0 EER 11.2 IEER	11.0 EER 12.0 IEER		AHRI 340/360
			All other	Split System and Single Package	10.8 EER 11.0 IEER		
	≥ 135,000 Btu/h and < 240,000 Btu/h	Electric Resistance (or None)	Split System and Single Package	10.6 EER 10.7 IEER	10.6 EER 11.6 IEER		
			All other	Split System and Single Package	10.4 EER 10.5 IEER	10.4 EER 11.4 IEER	
	≥ 240,000 Btu/h	Electric Resistance (or None)	Split System and Single Package	9.5 EER 9.6 IEER	9.5 EER 10.6 IEER		
			All other	Split System and Single Package	9.3 EER 9.4 IEER	9.3 EER 9.4 IEER	
Water to Air: Water Loop (cooling mode)	< 17,000 Btu/h	All	86°F entering water	12.2 EER	12.2 EER	ISO 13256-1	
	≥ 17,000 Btu/h and < 65,000 Btu/h	All	86°F entering water	13.0 EER	13.0 EER		
	≥ 65,000 Btu/h and < 135,000 Btu/h	All	86°F entering water	13.0 EER	13.0 EER		
Water to Air: Ground Water (cooling mode)	< 135,000 Btu/h	All	59°F entering water	18.0 EER	18.0 EER	ISO 13256-1	
Brine to Air: Ground Loop (cooling mode)	< 135,000 Btu/h	All	77°F entering water	14.1 EER	14.1 EER	ISO 13256-1	
Water to Water: WaterLoop (cooling mode)	< 135,000 Btu/h	All	86°F entering water	10.6 EER	10.6 EER	ISO 13256-2	
Water to Water: Ground Water (cooling mode)	< 135,000 Btu/h	All	59°F entering water	16.3 EER	16.3 EER		
Brine to Water: Ground Loop (cooling mode)	< 135,000 Btu/h	All	77°F entering fluid	12.1 EER	12.1 EER		

(continued)

TABLE C403.2.3(2)—continued
 MINIMUM EFFICIENCY REQUIREMENTS:
 ELECTRICALLY OPERATED UNITARY AND APPLIED HEAT PUMPS

EQUIPMENT TYPE	SIZE CATEGORY	HEATING SECTION TYPE	SUBCATEGORY OR RATING CONDITION	MINIMUM EFFICIENCY		TEST PROCEDURE ^a
				Before 1/1/2016	As of 1/1/2016	
Air cooled (heating mode)	< 65,000 Btu/h ^b	—	Split System	7.7 HSPF ^c	8.2 HSPF ^c	AHRI 210/240
		—	Single Package	7.7 HSPF ^c	8.0 HSPF ^c	
Through-the-wall, (air cooled, heating mode)	≤ 30,000 Btu/h ^b (cooling capacity)	—	Split System	7.4 HSPF	7.4 HSPF	
		—	Single Package	7.4 HSPF	7.4 HSPF	
Small-duct high velocity (air cooled, heating mode)	< 65,000 Btu/h ^b	—	Split System	6.8 HSPF	6.8 HSPF	
Air cooled (heating mode)	≥ 65,000 Btu/h and < 135,000 Btu/h (cooling capacity)	—	47°F db/43°F wb outdoor air	3.3 COP	3.3 COP	
			17°F db/15°F wb outdoor air	2.25 COP	2.25 COP	
	≥ 135,000 Btu/h (cooling capacity)	—	47°F db/43°F wb outdoor air	3.2 COP	3.2 COP	
			17°F db/15°F wb outdoor air	2.05 COP	2.05 COP	
Water to Air: Water Loop (heating mode)	< 135,000 Btu/h (cooling capacity)	—	68°F entering water	4.3 COP	4.3 COP	ISO 13256-1
Water to Air: Ground Water (heating mode)	< 135,000 Btu/h (cooling capacity)	—	50°F entering water	3.7 COP	3.7 COP	
Brine to Air: Ground Loop (heating mode)	< 135,000 Btu/h (cooling capacity)	—	32°F entering fluid	3.2 COP	3.2 COP	
Water to Water: Water Loop (heating mode)	< 135,000 Btu/h (cooling capacity)	—	68°F entering water	3.7 COP	3.7 COP	ISO 13256-2
Water to Water: Ground Water (heating mode)	< 135,000 Btu/h (cooling capacity)	—	50°F entering water	3.1 COP	3.1 COP	
Brine to Water: Ground Loop (heating mode)	< 135,000 Btu/h (cooling capacity)	—	32°F entering fluid	2.5 COP	2.5 COP	

For SI: 1 British thermal unit per hour = 0.2931 W, °C = [(°F) - 32]/1.8.

- a. Chapter 6 contains a complete specification of the referenced test procedure, including the reference year version of the test procedure.
- b. Single-phase, air-cooled air conditioners less than 65,000 Btu/h are regulated by NAECA. SEER values are those set by NAECA.
- c. Minimum efficiency as of January 1, 2015.

Minimum Efficiency Requirements: 2018 IECC (baseline effective 7/1/2019 to 9/30/2022)

TABLE C403.3.2(2)
MINIMUM EFFICIENCY REQUIREMENTS: ELECTRICALLY OPERATED UNITARY AND APPLIED HEAT PUMPS

EQUIPMENT TYPE	SIZE CATEGORY	HEATING SECTION TYPE	SUBCATEGORY OR RATING CONDITION	MINIMUM EFFICIENCY	TEST PROCEDURE ^a
Air cooled (cooling mode)	< 65,000 Btu/h ^b	All	Split System	14.0 SEER	AHRI 210/240
			Single Package	14.0 SEER	
Through-the-wall, air cooled	≤ 30,000 Btu/h ^b	All	Split System	12.0 SEER	
			Single Package	12.0 SEER	
Single-duct high-velocity air cooled	< 65,000 Btu/h ^b	All	Split System	11.0 SEER	
Air cooled (cooling mode)	≥ 65,000 Btu/h and < 135,000 Btu/h	Electric Resistance (or None)	Split System and Single Package	11.0 EER 12.0 IEER	
		All other	Split System and Single Package	10.8 EER 11.8 IEER	
	≥ 135,000 Btu/h and < 240,000 Btu/h	Electric Resistance (or None)	Split System and Single Package	10.6 EER 11.6 IEER	
		All other	Split System and Single Package	10.4 EER 11.4 IEER	
	≥ 240,000 Btu/h	Electric Resistance (or None)	Split System and Single Package	9.5 EER 10.6 IEER	
		All other	Split System and Single Package	9.3 EER 9.4 IEER	
Water to Air: Water Loop (cooling mode)	< 17,000 Btu/h	All	86°F entering water	12.2 EER	ISO 13256-1
	≥ 17,000 Btu/h and < 65,000 Btu/h	All	86°F entering water	13.0 EER	
	≥ 65,000 Btu/h and < 135,000 Btu/h	All	86°F entering water	13.0 EER	
Water to Air: Ground Water (cooling mode)	< 135,000 Btu/h	All	59°F entering water	18.0 EER	ISO 13256-1
Brine to Air: Ground Loop (cooling mode)	< 135,000 Btu/h	All	77°F entering water	14.1 EER	ISO 13256-1
Water to Water: Water Loop (cooling mode)	< 135,000 Btu/h	All	86°F entering water	10.6 EER	ISO 13256-2
Water to Water: Ground Water (cooling mode)	< 135,000 Btu/h	All	59°F entering water	16.3 EER	
Brine to Water: Ground Loop (cooling mode)	< 135,000 Btu/h	All	77°F entering fluid	12.1 EER	

IECC2018 Table C403.3.2(2) continued from previous page:

Air cooled (heating mode)	< 65,000 Btu/h ^b	—	Split System	8.2 HSPF	AHRI 210/240
		—	Single Package	8.0 HSPF	
Through-the-wall, (air cooled, heating mode)	≤ 30,000 Btu/h ^b (cooling capacity)	—	Split System	7.4 HSPF	
		—	Single Package	7.4 HSPF	
Small-duct high velocity (air cooled, heating mode)	< 65,000 Btu/h ^b	—	Split System	6.8 HSPF	
Air cooled (heating mode)	≥ 65,000 Btu/h and < 135,000 Btu/h (cooling capacity)	—	47°F db/43°F wb outdoor air	3.3 COP	
			17°Fdb/15°F wb outdoor air	2.25 COP	
	≥ 135,000 Btu/h (cooling capacity)	—	47°F db/43°F wb outdoor air	3.2 COP	
			17°Fdb/15°F wb outdoor air	2.05 COP	
Water to Air: Water Loop (heating mode)	< 135,000 Btu/h (cooling capacity)	—	68°F entering water	4.3 COP	ISO 13256-1
Water to Air: Ground Water (heating mode)	< 135,000 Btu/h (cooling capacity)	—	50°F entering water	3.7 COP	
Brine to Air: Ground Loop (heating mode)	< 135,000 Btu/h (cooling capacity)	—	32°F entering fluid	3.2 COP	
Water to Water: Water Loop (heating mode)	< 135,000 Btu/h (cooling capacity)	—	68°F entering water	3.7 COP	ISO 13256-2
Water to Water: Ground Water (heating mode)	< 135,000 Btu/h (cooling capacity)	—	50°F entering water	3.1 COP	
Brine to Water: Ground Loop (heating mode)	< 135,000 Btu/h (cooling capacity)	—	32°F entering fluid	2.5 COP	

For SI: 1 British thermal unit per hour = 0.2931 W, °C = [(°F) - 32]/1.8.

- a. Chapter 6 contains a complete specification of the referenced test procedure, including the reference year version of the test procedure.
- b. Single-phase, air-cooled heat pumps less than 65,000 Btu/h are regulated by NAECA. SEER and HSPF values are those set by NAECA.

Minimum Efficiency Requirements: 2021 IECC (baseline effective 10/1/2022 for New Construction measures)

TABLE C403.3.2(2)
ELECTRICALLY OPERATED AIR-COOLED UNITARY HEAT PUMPS—MINIMUM EFFICIENCY REQUIREMENTS^{a, d}

EQUIPMENT TYPE	SIZE CATEGORY	HEADING SECTION TYPE	SUBCATEGORY OR RATING CONDITION	MINIMUM EFFICIENCY	TEST PROCEDURE ^a
Air cooled (cooling mode)	< 66,000 Btu/h	All	Split system, three phase and applications outside US single phase ^b	14.0 SEER before 1/1/2023 14.3 SEER2 after 1/1/2023	AHRI 210/240—2017 before 1/1/2023 AHRI 210/240—2023 after 1/1/2023
			Single package, three phase and applications outside US single phase ^b	14.0 SEER before 1/1/2023 13.4 SEER2 after 1/1/2023	
Space constrained, air cooled (cooling mode)	≤ 30,000 Btu/h	All	Split system, three phase and applications outside US single phase ^b	12.0 SEER before 1/1/2023 11.7 SEER2 after 1/1/2023	AHRI 210/240—2017 before 1/1/2023 AHRI 210/240—2023 after 1/1/2023
			Single package, three phase and applications outside US single phase ^b	12.0 SEER before 1/1/2023 11.7 SEER2 after 1/1/2023	
Single duct, high velocity, air cooled (cooling mode)	< 65,000	All	Split system, three phase and applications outside US single phase ^b	12.0 SEER before 1/1/2023 12.0 SEER2 after 1/1/2023	AHRI 210/240—2017 before 1/1/2023 AHRI 210/240—2023 after 1/1/2023
Air cooled (cooling mode)	≥ 65,000 Btu/h and < 135,000 Btu/h	Electric resistance (or none)	Split system and single package	11.0 EER 12.2 IEER before 1/1/2023 14.1 IEER after 1/1/2023	AHRI 340/360
		All other		10.8 EER 12.0 IEER before 1/1/2023 13.9 IEER after 1/1/2023	
	≥ 135,000 Btu/h and < 240,000 Btu/h	Electric resistance (or none)		10.6 EER 11.6 IEER before 1/1/2023 13.5 IEER after 1/1/2023	
		All other		10.4 EER 11.4 IEER before 1/1/2023 13.3 IEER after 1/1/2023	
	≥ 240,000 Btu/h	Electric resistance (or none)		9.5 EER 10.6 IEER before 1/1/2023 12.5 IEER after 1/1/2023	
		All other		9.3 EER 10.4 IEER before 1/1/2023 12.3 IEER after 1/1/2023	
Air cooled (heating mode)	< 65,000 Btu/h	All	Split system, three phase and applications outside US single phase ^b	8.2 HSPF before 1/1/2023 7.5 HSPF2 after 1/1/2023	AHRI 210/240—2017 before 1/1/2023 AHRI 210/240—2023 after 1/1/2023
			Single package, three phase and applications outside US single phase ^b	8.0 HSPF before 1/1/2023 6.7 HSPF2 after 1/1/2023	

IECC2021 Table C403.3.2(2) continued from previous page

**TABLE C403.3.2(2)—continued
ELECTRICALLY OPERATED AIR-COOLED UNITARY HEAT PUMPS—MINIMUM EFFICIENCY REQUIREMENTS^{a, d}**

EQUIPMENT TYPE	SIZE CATEGORY	HEADING SECTION TYPE	SUBCATEGORY OR RATING CONDITION	MINIMUM EFFICIENCY	TEST PROCEDURE ^e
Space constrained, air cooled (heating mode)	≤ 30,000 Btu/h	All	Split system, three phase and applications outside US single phase ^b	7.4 HSPF before 1/1/2023 6.3 HSPF2 after 1/1/2023	AHRI 210/240—2017 before 1/1/2023 AHRI 210/240—2023 after 1/1/2023
			Single package, three phase and applications outside US single phase ^b	7.4 HSPF before 1/1/2023 6.3 HSPF2 after 1/1/2023	
Small duct, high velocity, air cooled (heating mode)	< 65,000 Btu/h	All	Split system, three phase and applications outside US single phase ^b	7.2 HSPF before 1/1/2023 6.1 HSPF2 after 1/1/2023	AHRI 210/240—2017 before 1/1/2023 AHRI 210/240—2023 after 1/1/2023
Air cooled (heating mode)	≥ 65,000 Btu/h and < 135,000 Btu/h (cooling capacity)	All	47°F db/43°F wb outdoor air	3.30 COP _H before 1/1/2023 3.40 COP _H after 1/1/2023	AHRI 340/360
			17°F db/15°F wb outdoor air	2.25 COP _H	
	≥ 135,000 Btu/h and < 240,000 Btu/h (cooling capacity)		47°F db/43°F wb outdoor air	3.20 COP _H before 1/1/2023 3.30 SOP _H after 1/1/2023	
			17°F db/15°F wb outdoor air	2.05 COP _H	
	≥ 240,000 Btu/h (cooling capacity)		47°F db/43°F wb outdoor air	3.20 COP _H	
			17°F db/15°F wb outdoor air	2.05 COP _H	

Non Fuel Switch example, a 5-ton single phase split system 60,000 Btuh capacity heat pump, with an efficiency SEER2 of 16, and an efficient HSPF2 of 9.5, at a new restaurant in Chicago with a building permit dated after 1/1/2023 saves:

$$\begin{aligned} \Delta kWh &= \text{Annual kWh Savings}_{\text{cool}} + \text{Annual kWh Savings}_{\text{heat}} \\ \text{Annual kWh Savings}_{\text{cool}} &= (\text{Capacity}_{\text{cool}} * \text{EFLH}_{\text{cool}} * (1/\text{SEER}_{\text{base}} - 1/\text{SEER}_{\text{ee}}))/1000 \\ \text{Annual kWh Savings}_{\text{heat}} &= (\text{HeatLoad} * (1/(\text{HSPF}_{\text{base}} * \text{HSPF}_{\text{ClimateAdj}}) - 1/(\text{HSPF}_{\text{ee}} * \text{HSPF}_{\text{ClimateAdj}}))/1000 \\ \Delta kWh &= (60,000 * 761 * (1/14.3 - 1/16))/1000 + (60,000 * 797 * (1/(7.5 * 0.7) - 1/(9.5 * 0.7)))/1000 \\ &= 2257 \text{ kWh} \end{aligned}$$

Fuel Switch Illustrative Examples

[for illustrative purposes 50:50 Incentive is used for joint programs]

New construction using gas furnace and central AC baseline:

For example, a 60,000 Btu, 16 SEER2, 9.5 HSPF2 single phase split system Air Site Heat Pump installed in a new Chicago restaurant, in place of a 120,000 Btuh natural gas furnace and 5 ton Central AC unit:

$$\begin{aligned} \text{SiteEnergySavings (MMBTUs)} &= \text{GasHeatReplaced} + \text{FurnaceFanSavings} - \text{HPSiteHeatConsumed} + \text{HPSiteCoolingImpact} \\ \text{GasHeatReplaced} &= (\text{HeatLoad} * 1/\text{AFUE}_{\text{base}}) / 1,000,000 \\ &= (60,000 * 797 * 1/0.8) / 1000000 \\ &= 59.8 \text{ MMBtu} \\ \text{FurnaceFanSavings} &= (\text{FurnaceFlag} * \text{HeatLoad} * 1/\text{AFUE}_{\text{base}} * F_e) / 1,000,000 \\ &= (1 * 60,000 * 797 * 1/0.8 * 0.077) / 1,000,000 \\ &= 4.6 \text{ MMBtu} \\ \text{HPSiteHeatConsumed} &= ((\text{HeatLoad} * (1/(\text{HSPF}_{\text{ee}} * \text{HSPF}_{\text{ClimateAdj}}))) / 1000 * 3412) / 1,000,000 \\ &= ((60,000 * 797 * (1/(9.5 * 0.77))) / 1000 * 3412) / 1,000,000 \\ &= 22.3 \text{ MMBtu} \\ \text{HPSiteCoolingImpact} &= ((\text{FLH}_{\text{cool}} * \text{Capacity}_{\text{cool}} * (1/\text{SEER}_{\text{base}} - 1/\text{SEER}_{\text{ee}}))/1000 * 3412) / 1,000,000 \\ &= ((761 * 60,000 * (1/14.3 - 1/16)) / 1000 * 3412) / 1,000,000 \\ &= 1.2 \text{ MMBtu} \\ \text{SiteEnergySavings (MMBTUs)} &= 59.8 + 4.6 - 22.3 + 1.2 = 43.3 \text{ MMBtu [Measure is eligible]} \end{aligned}$$

Fuel Switch Illustrative Example continued

Savings would be claimed as follows:

Measure supported by:	Electric Utility claims:	Gas Utility claims:
Electric utility only	43.3 * 1,000,000/3412 = 12,691 kWh	N/A
Electric and gas utility	0.5 * 43.3 * 1,000,000/3412 = 6,345 kWh	0.5 * 43.3 * 10 = 217 Therms
Gas utility only	N/A	43.3 * 10 = 433 Therms

SUMMER COINCIDENT PEAK DEMAND SAVINGS

$$\Delta kW = ((\text{Capacity}_{\text{cool}}/\text{DuctlessSave} * 1/\text{EER2}_{\text{base}}) - (\text{Capacity}_{\text{cool}} * 1/\text{EER2}_{\text{ee}})) / 1000 * \text{CF}$$

Where CF value is chosen between:

$$\text{CF}_{\text{SSP}} = \text{Summer System Peak Coincidence Factor for Commercial cooling (during system peak hour)} \\ = 91.3\% \text{ }^{661}$$

$$\text{CF}_{\text{PJM}} = \text{PJM Summer Peak Coincidence Factor for Commercial cooling (average during peak period)} \\ = 47.8\% \text{ }^{662}$$

For example, a 5 ton single phase split system air source heat pump, with an efficient EER2 of 12.5 with a building permit dated after 1/1/2023 saves:

$$\Delta kW = ((60,000/1 * 1/9.4) - (60,000 * 1/12.5))/1000 * 0.913 \\ = 1.44 \text{ kW}$$

FOSSIL FUEL SAVINGS

Calculation provided together with Electric Energy Savings above.

WATER IMPACT DESCRIPTIONS AND CALCULATION

N/A

DEEMED O&M COST ADJUSTMENT CALCULATION

N/A

COST EFFECTIVENESS SCREENING AND LOAD REDUCTION FORECASTING WHEN FUEL SWITCHING

This measure can involve fuel switching from gas to electric.

For the purposes of forecasting load reductions due to fuel switch ASHP projects per Section 16-111.5B, changes in site energy use at the customer’s meter (using ΔkWh algorithm below), customer switching estimates, NTG, and any other adjustment factors deemed appropriate, should be used.

⁶⁶¹ Based on analysis of Itron eShape data for Missouri, calibrated to Illinois loads, supplied by Ameren. The AC load during the utility’s peak hour is divided by the maximum AC load during the year.

⁶⁶² Based on analysis of Itron eShape data for Missouri, calibrated to Illinois loads, supplied by Ameren. The average AC load over the PJM peak period (1-5pm, M-F, June through August) is divided by the maximum AC load during the year.

The inputs to cost effectiveness screening should reflect the actual impacts on the electric and fuel consumption at the customer meter and, for fuel switching measures, should therefore reflect the decrease in one fuel and increase in another, as opposed to the single savings value calculated in the “Electric and Fossil Fuel Energy Savings” section above. Therefore in addition to the calculation of savings claimed, the following values should be used to assess the cost effectiveness of the measure. For Early Replacement measures, the efficiency terms of the existing unit should be used for the remaining useful life of the existing equipment (6 years for ASHP and Central AC, 7 years for furnace, 8 years for boilers or GSHP, 15 years for electric resistance), and the efficiency terms for a new baseline unit should be used for the remaining years of the measure.

$$\begin{aligned} \Delta\text{Therms} &= [\text{Heating Consumption Replaced}] \\ &= [(\% \text{FuelSwitch} * \text{HeatLoad_Disp/DuctlessSave} * 1/\text{AFUE}_{\text{base}}) / 100,000] \end{aligned}$$

$$\Delta\text{kWh} = [\text{FurnaceFanSavings}] - [\text{HP heating consumption}] + [\text{Cooling savings}]$$

For units with cooling capacities less than 65 kBtu/hr:

$$\begin{aligned} &= \% \text{FuelSwitch} * [\text{FurnaceFlag} * \text{HeatLoad_Disp/DuctlessSave} * 1/\text{AFUE}_{\text{base}} * F_e * \\ &0.000293] - [(\text{HeatLoad_Disp} * (1/(\text{HSPF2}_{\text{ee}} * \text{HSPF2_ClimateAdj} * \text{PD_Adj}))/1000] + \\ &[[\text{CoolingLoad/DuctlessSave} * 1/\text{SEER2}_{\text{base}}] - (\text{CoolingLoad} * 1/\text{SEER2}_{\text{ee}})]/1000] \end{aligned}$$

For units with cooling capacities greater than 65 kBtu/hr:

$$\begin{aligned} &= \% \text{FuelSwitch} * [\text{FurnaceFlag} * \text{HeatLoad_Disp} * 1/\text{AFUE}_{\text{base}} * F_e * 0.000293] - \\ &[\text{HeatLoad_Disp}/3412 * 1/(\text{COP}_{\text{ee}} * \text{PD_Adj})] + [(\text{CoolingLoad} * (1/\text{IEER}_{\text{base}} - \\ &1/\text{IEER}_{\text{ee}}))/1000] \end{aligned}$$

MEASURE CODE: CI-HVC-HPSY-V12-250101

REVIEW DEADLINE: 1/1/2028

4.4.10 High Efficiency Boiler

DESCRIPTION

To qualify for this measure the installed equipment must be replacement of an existing boiler at the end of its service life, in a commercial or multifamily space with a high efficiency, gas-fired steam or hot water boiler. High efficiency boilers achieve gas savings through the utilization of a sealed combustion chamber and multiple heat exchangers that remove a significant portion of the waste heat from flue gasses. Because multiple heat exchangers are used to remove waste heat from the escaping flue gasses, some of the flue gasses condense and must be drained.

This measure was developed to be applicable to the following program types: TOS, NC. If applied to other program types, the measure savings should be verified.

DEFINITION OF EFFICIENT EQUIPMENT

To qualify for this measure the installed equipment must be a boiler used 80% or more for space heating, not process, and boiler AFUE, E_T (thermal efficiency), or E_C (combustion efficiency) rating must be rated greater than or equal to 85% for hot water boilers and 83% for steam boilers.

DEFINITION OF BASELINE EQUIPMENT

Dependent on when the unit is installed and whether the unit is hot water or steam. The baseline efficiency source is the Energy Independence and Security Act of 2007 with technical amendments from Federal Register, volume 81, Number 10, January 15, 2016 for boilers <300,000 and Federal Register, volume 74, Number 139, July 22, 2009 for boilers >300,000 Btu/hr.⁶⁶³

For boilers <300,000 Btu/hr the technical amendments include the recent compliance dates for gas-fired hot water and steam boilers manufactured on or after January 15, 2021.⁶⁶⁴

Note, for natural draft steam boilers, as IECC 2021, Illinois state energy code that is expected to become effective statewide in 2024, exceeds the minimum federal efficiency standards, it was replaced in favor of the more aggressive thermal efficiency values in the table below. For new construction applications where the permitting date is prior to the state’s adoption of IECC 2021, it is recommended to use the applicable edition of IECC corresponding to that timeline. As code requirements and adoption can differ from municipality to municipality, the user should verify which version of code is applicable given these constraints.

Each gas-fired commercial packaged boiler must meet the applicable energy conservation standard levels detailed in the table below.

Boiler baseline efficiency standards

Boiler Type	Efficiency
Hot Water Boiler < 300,000 Btu/h	84% AFUE
Hot Water Boiler \geq 300,000 Btu/h and \leq 2,500,000 Btu/h	80% E_T
Hot Water Boiler > 2,500,000 Btu/h	82% E_C
Steam Boiler < 300,000 Btu/h	82% AFUE
Steam Boiler \geq 300,000 Btu/h and \leq 2,500,000 Btu/h	79% E_T
Steam Boiler \geq 2,500,000 Btu/h	79% E_T

DEEMED LIFETIME OF EFFICIENT EQUIPMENT

The expected measure life is assumed to be 25 years.⁶⁶⁵

⁶⁶³ Energy Conservation Standards for Commercial Boilers, Code of Federal Regulations, 10 CFR 431.87

⁶⁶⁴ Code of Federal Regulations, effective January 15, 2021 (10 CFR 432(e)(3)).

⁶⁶⁵ Consistent with DOE assumption determined through a literature review in Appendix 8-F of the Department of Energy Commercial Technical Support Document.

DEEMED MEASURE COST

The measure cost for this technology is tiered based on the boiler type and combustion efficiencies. As installation costs for the base case and the measure case units are assumed to be the same, labor costs are not specified for this measure.

Incremental and Gross Measure costs for Space Heating Boilers

Boiler Type	Incremental Measure Cost (\$/KBtu) ⁶⁶⁶	Full Installed Measure Cost (\$/KBtu) ⁶⁶⁷
Hot Water Boiler ≥85% E _c and <90% E _c	\$2.17	\$12.94
Hot Water Boiler ≥90% E _c	\$12.17	\$22.95
Steam Boiler ≥83% E _c and <85% E _c	\$4.35	\$19.24
Modular Steam Boiler Arrays (≥85% E _c) ⁶⁶⁸	Custom	

LOADSHAPE

N/A

COINCIDENCE FACTOR

N/A

Algorithm

CALCULATION OF ENERGY SAVINGS

ELECTRIC ENERGY SAVINGS

N/A

SUMMER COINCIDENT PEAK DEMAND SAVINGS

N/A

FOSSIL FUEL SAVINGS

$$\Delta\text{Therms} = \text{EFLH} * \text{Capacity} * ((\text{Efficiency}_{\text{EE}} - \text{Efficiency}_{\text{Base}}) / \text{Efficiency}_{\text{Base}}) / 100,000$$

Where:

EFLH = Equivalent Full Load Hours for heating in Existing Buildings or New Construction are provided in section 4.4 HVAC End Use

Capacity = Nominal Heating Input Capacity Boiler Size (Btu/hr) for efficient unit not existing unit
 = custom Boiler input capacity in Btu/hr

Efficiency_{Base} = Baseline Boiler Efficiency Rating, dependant on year and boiler type

Hot water boiler baseline:

Boiler Capacity and Distribution Type	Efficiency
Hot Water <300,000 Btu/hr ⁶⁶⁹	84% AFUE
Hot Water ≥300,000 & ≤2,500,000 Btu/hr ⁶⁷⁰	80% E _T

⁶⁶⁶ Ibid.

⁶⁶⁷ Ibid.

⁶⁶⁸ Miura Modular Boilers, <https://s29958.pcdn.co/wp-content/uploads/2019/03/LXBrochure2016.pdf>

⁶⁶⁹ Code of Federal Regulations, effective January 15, 2021 (10 CFR 432(e)(3)).

⁶⁷⁰ Thermal Efficiency. Code of Federal Regulations, effective March 2, 2012 (10 CFR 431.87).

Boiler Capacity and Distribution Type	Efficiency
Hot Water Boiler > 2,500,000 ⁶⁷¹	82% E _c

Steam boiler baseline:

Boiler Capacity and Distribution Type	Efficiency
Steam <300,000 Btu/hr ⁶⁷²	82% AFUE
Steam Boiler ≥ 300,000 Btu/h and ≤ 2,500,000 Btu/h ⁶⁷³	79% E _T
Steam - natural draft ≥300,000 & ≤2,500,000 Btu/hr	79% TE ⁶⁷⁴
Steam Boiler >2,500,000 Btu/h	79% E _T
Steam - natural draft >2,500,000 Btu/hr	79% E _T ⁶⁷⁵

Efficiency_{EE} = Efficient Boiler Efficiency Rating
 =actual value, specified to one significant digit (i.e., 95.7%)

For example, a 150,000 btu/hr water boiler meeting AFUE 90% is installed in Rockford at a high rise office building , in the year 2022

$$\begin{aligned} \Delta\text{Therms} &= 2,089 * 150,000 * (0.90-0.840)/0.840 / 100,000 \text{ Btu/Therm} \\ &= 224 \text{ Therms} \end{aligned}$$

WATER IMPACT DESCRIPTIONS AND CALCULATION

N/A

DEEMED O&M COST ADJUSTMENT CALCULATION

N/A

MEASURE CODE: CI-HVC-BOIL-V12-240101

REVIEW DEADLINE: 1/1/2027

⁶⁷¹ Combustion Efficiency. Code of Federal Regulations, effective March 2, 2012 (10 CFR 431.87).

⁶⁷² Code of Federal Regulations, effective January 15, 2021 (10 CFR 432(e)(3)).

⁶⁷³ Code of Federal Regulations, effective March 2, 2012 (10 CFR 431.87). Includes efficiency requirements for all steam boilers ≥ 300,000 Btu/hr.

⁶⁷⁴ IECC 2021

⁶⁷⁵ IECC 2021

4.4.11 High Efficiency Furnace

DESCRIPTION

This measure covers the installation of a residential sized (<225,000 Btu/hr) or commercial sized (≥225,000 Btu/hr) high efficiency gas furnace in lieu of a standard efficiency gas furnace in a commercial or industrial space. Note commercial sized condensing gas units (≥ 225,000 Btu/hr) heating 100% outside air should use 4.4.37 Unitary HVAC Condensing Furnace if appropriate. High efficiency gas furnaces achieve savings through the utilization of a sealed, super insulated combustion chamber, more efficient burners, and multiple heat exchangers that remove a significant portion of the waste heat from the flue gasses. Because multiple heat exchangers are used to remove waste heat from the escaping flue gasses, most of the flue gasses condense and must be drained.

This measure also describes savings from a brushless permanent magnet (BPM) motor (known and referred in this measure as an electronically commutated motor (ECM)) compared to a lower efficiency motor within a residential sized unit. Time of Sale and New Construction scenarios can no longer claim these electrical savings, as federal standards make ECM blower fan motors a requirement for residential-sized furnaces.⁶⁷⁶ Savings however are available from replacing an operational inefficient furnace with a new furnace with an ECM prior to the end of its life.

This measure was developed to be applicable to the following program types: TOS, NC and EREP. If applied to other program types, the measure savings should be verified.

Time of sale:

- a. The installation of a new high efficiency, gas-fired condensing furnace in a commercial location. This could relate to the replacement of an existing unit at the end of its useful life, or the installation of a new system.

Early replacement:

Early Replacement determination will be based on meeting the following conditions:

- The existing unit is operational when replaced, or
- The existing unit requires minor repairs (<\$528).⁶⁷⁷
- All other conditions will be considered Time of Sale.

The Baseline AFUE of the existing unit replaced:

- If the AFUE of the existing unit is known, the Baseline AFUE is the actual AFUE value of the unit replaced.
- If the AFUE of the existing unit is unknown, use assumptions in variable list below (AFUE(exist)).
- If the operational status or repair cost of the existing unit is unknown, use time of sale assumptions.

DEFINITION OF EFFICIENT EQUIPMENT

To qualify for this measure the installed equipment must be a furnace with input energy less than 225,000 Btu/hr rated natural gas fired furnace with an Annual Fuel Utilization Efficiency (AFUE) rating and fan electrical efficiency exceeding the program requirements:

DEFINITION OF BASELINE EQUIPMENT

Time of Sale: The current Federal Standard for gas furnaces <225,000 Btu/hr is an AFUE rating of 80%.

⁶⁷⁶ As part of the code of federal regulations, energy conservation standards for covered residential furnace fans become effective on July 3, 2019 (10 CFR 430.32(y)). The expectation is the baseline will essentially become an ECM motor.

⁶⁷⁷ The Technical Advisory Committee agreed that if the cost of repair is less than 20% of the new baseline replacement cost it can be considered early replacement. Note the non-inflated cost is used as this would be a cost consideration in the program year.

For furnaces $\geq 225,000$ Btu/hr, the baseline AFUE rating is 81%.

Early replacement: The baseline for this measure is the efficiency of the existing equipment for the assumed remaining useful life of the unit and a new baseline 80% AFUE for Residential sized or 81% AFUE for Commercial sized unit for the remainder of the measure life.

DEFINITION OF MEASURE LIFE

The expected measure life is assumed to be 16.5 years.⁶⁷⁸

Remaining life of existing equipment is assumed to be 5.5 years.⁶⁷⁹

DEEMED MEASURE COST

For residential sized units (<225,000 Btu/hr):

Time of Sale: The incremental capital cost for this measure depends on efficiency as listed below:⁶⁸⁰

AFUE	Installation Cost	Incremental Install Cost
80%	\$3807	n/a
90%	\$4332	\$526
91%	\$4338	\$531
92%	\$4345	\$538
93%	\$4346	\$540
94%	\$4351	\$544
95%	\$4354	\$547
96%	\$4422	\$615
97%	\$4490	\$683
98%	\$4557	\$751

Early Replacement: The full installation cost is provided in the table above. The assumed deferred cost (after 5.5 years) of replacing existing equipment with a new 80% baseline unit is assumed to be \$2,231.⁶⁸¹ This cost should be discounted to present value using the nominal discount rate.

For commercial sized units ($\geq 225,000$ Btu/hr) – actual costs should be used.

LOADSHAPE

N/A

COINCIDENCE FACTOR

N/A

⁶⁷⁸ Average of 15-18 year lifetime estimate made by the Consortium for Energy Efficiency in 2010.

⁶⁷⁹ Assumed to be one third of effective useful life.

⁶⁸⁰ Based on data from Technical Support Document: Consumer Furnaces. EERE-2014-BT-STD-0031-0320. Department of Energy. June 2022. The total installed cost quoted by DOE was increased by 15% to account for DOE's assumption of an ideal future market (projected from 2022 to 2029) in their development of their technical support documentation. This was an engineering judgment made to better represent real world costs.

⁶⁸¹ \$2011 inflated using 1.91% rate.

Algorithm

CALCULATION OF SAVINGS

ELECTRIC ENERGY SAVINGS

Residential sized (<225,000 Btu/hr), Early Replacement Only:

For remaining useful life of the existing furnace (assumed 5.5 years):

$$\Delta kWh = \text{Heating Savings} + \text{Cooling Savings} + \text{Shoulder Season Savings}$$

Where:

Heating Savings = Brushless DC motor or Electronically commutated motor (ECM)
= 418 kWh⁶⁸²

Cooling Savings = Brushless DC motor or electronically commutated motor (ECM) savings during cooling season

If air conditioning = 263 kWh

If no air conditioning = 175 kWh

If unknown (weighted average)= 241 kWh⁶⁸³

Shoulder Season Savings = Brushless DC motor or electronically commutated motor (ECM) savings during shoulder seasons

= 51 kWh

For example, a blower motor in a low rise office building where air conditioning presence is unknown:

$$\begin{aligned} \Delta kWh &= \text{Heating Savings} + \text{Cooling Savings} + \text{Shoulder Season Savings} \\ &= 418 + 241 + 51 \\ &= 710 \text{ kWh} \end{aligned}$$

For remaining measure life of the existing furnace (next 11 years): 0 kWh

All other applications assume 0 kWh.

SUMMER COINCIDENT PEAK DEMAND SAVINGS

Residential sized (<225,000 Btu/hr) Early Replacement Only:

For remaining useful life of the existing furnace (assumed 5.5 years):

For units that have evaporator coils and condensing units and are cooling in the summer in addition to heating in the winter the summer coincident peak demand savings should be calculated. If the unit is not equipment with coils or condensing units, the summer peak demand savings will not apply.

$$\Delta kW = (\text{CoolingSavings}/\text{HOURSyear}) * CF$$

⁶⁸² To estimate heating, cooling and shoulder season savings for Illinois, VEIC adapted results from a 2009 Focus on Energy study of BPM blower motor savings in Wisconsin. This study included effects of behavior change based on the efficiency of new motor greatly increasing the amount of people that run the fan continuously. The savings from the Wisconsin study were adjusted to account for different run hour assumptions (average values used) for Illinois. See: FOE to IL Blower Savings.xlsx.

⁶⁸³ The weighted average value is based on assumption that 75% of buildings installing BPM furnace blower motors have Central AC.

Where:

HOURS_{year} = Actual hours per year if known, otherwise use hours from Table below for building type:⁶⁸⁴

Building Type	HOURS _{year}	Model source
Assembly	2150	eQuest
Assisted Living	4373	eQuest
Auto Dealership	1605	OpenStudio
College	4065	OpenStudio
Convenience Store	2084	eQuest
Drug Store	1708	OpenStudio
Elementary School	2649	OpenStudio
Emergency Services	3277	OpenStudio
Garage	2102	eQuest
Grocery	5470	OpenStudio
Healthcare Clinic	6364	OpenStudio
High School	3141	eQuest
Hospital - VAV econ	8707	OpenStudio
Hospital - CAV econ	2336	OpenStudio
Hospital - CAV no econ	4948	OpenStudio
Hospital - FCU	8760	OpenStudio
Manufacturing Facility	2805	eQuest
MF - High Rise	6823	OpenStudio
MF - Mid Rise	4996	OpenStudio
Hotel/Motel – Guest	4155	OpenStudio
Hotel/Motel - Common	6227	OpenStudio
Movie Theater	2120	eQuest
Office - High Rise - VAV econ	3414	OpenStudio
Office - High Rise - CAV econ	4849	eQuest
Office - High Rise - CAV no econ	6049	OpenStudio
Office - High Rise - FCU	5341	OpenStudio
Office - Low Rise	3835	OpenStudio
Office - Mid Rise	3040	OpenStudio
Religious Building	2830	eQuest
Restaurant	2305	OpenStudio
Retail - Department Store	2528	eQuest
Retail - Strip Mall	2266	eQuest
Warehouse	770	eQuest
Unknown	2987	n/a

CF =Summer Peak Coincidence Factor for measure is provided below for different building types:⁶⁸⁵

HVAC Pumps	CF
Assembly	48.3%
Assisted Living	52.9%
College	14.2%

⁶⁸⁴ Hours per year are estimated using the eQuest or OpenStudio models as the total number of hours the cooling system is operating for each building type.

⁶⁸⁵ Coincidence Factors are estimated using the eQuest models.

HVAC Pumps	CF
Convenience Store	57.1%
Elementary School	33.3%
Emergency Services	19.6%
Garage	61.9%
Grocery	47.5%
Healthcare Clinic	61.9%
High School	28.8%
Hospital - VAV econ	57.6%
Hospital - CAV econ	61.5%
Hospital - CAV no econ	64.8%
Hospital - FCU	60.9%
Manufacturing Facility	43.3%
MF - High Rise - Common	43.7%
MF - Mid Rise	24.3%
Hotel/Motel - Guest	62.9%
Hotel/Motel - Common	64.6%
Movie Theater	41.9%
Office - High Rise - VAV econ	43.2%
Office - High Rise - CAV econ	48.3%
Office - High Rise - CAV no econ	50.3%
Office - High Rise - FCU	46.2%
Office - Low Rise	47.4%
Office - Mid Rise	42.8%
Religious Building	43.3%
Restaurant	48.8%
Retail - Department Store	50.5%
Retail - Strip Mall	52.8%
Warehouse	22.5%
Unknown	42.4%

For example, a blower motor in a low rise office building where air conditioning presence is unknown:

$$\begin{aligned} \Delta kW &= (241 / 2481) * 0.474 \\ &= 0.05 \text{ kW} \end{aligned}$$

For remaining measure life of the existing furnace (next 11 years): 0 kW

All other applications assume 0 kWh.

FOSSIL FUEL SAVINGS

Time of Sale:

$$\Delta \text{Therms} = (\text{EFLH} * \text{Capacity} * (\text{AFUE}(\text{eff}) / \text{AFUE}(\text{base}) - 1)) / 100,000$$

Early replacement⁶⁸⁶:

⁶⁸⁶ The two equations are provided to show how savings are determined during the initial phase of the measure (existing to efficient) and the remaining phase (new baseline to efficient). In practice, the screening tools used may either require a First

ΔTherms for remaining life of existing unit (1st 5.5 years):

$$\Delta\text{Therms} = (\text{EFLH} * \text{Capacity} * (\text{AFUE}(\text{eff}) / \text{AFUE}(\text{exist}) - 1)) / 100,000$$

ΔTherms for remaining measure life (next 11 years):

$$\Delta\text{Therms} = (\text{EFLH} * \text{Capacity} * (\text{AFUE}(\text{eff}) / \text{AFUE}(\text{base}) - 1)) / 100,000$$

Where:

- EFLH = Equivalent Full Load Hours for heating in Existing Buildings or New Construction are provided in section 4.4 HVAC End Use
- Capacity = Nominal Heating Input Capacity Furnace Size (Btu/hr) for efficient unit not existing unit
= custom Furnace input capacity in Btu/hr
- AFUE(exist) = Existing Furnace Annual Fuel Utilization Efficiency Rating
= Use actual AFUE rating where it is possible to measure or reasonably estimate.
If unknown, assume 64.4 AFUE%.⁶⁸⁷
- AFUE(base) = Baseline Furnace Annual Fuel Utilization Efficiency Rating
= For residential sized units (<225,000 Btu/hr): 80%⁶⁸⁸
= For commercial sized units (>=225,000 Btu/hr):

Program	AFUE(base)
Time of Sale	81% ⁶⁸⁹
Early Replacement	81% ⁶⁹⁰

- AFUE(eff) = Efficient Furnace Annual Fuel Utilization Efficiency Rating.
= Actual. If Unknown, assume 95%.⁶⁹¹

For example,

$$\begin{aligned} \Delta\text{Therms} &= (1428 * 150,000 * (0.92 / 0.80 - 1)) / 100,000 \\ &= 321 \text{ Therms} \end{aligned}$$

WATER IMPACT DESCRIPTIONS AND CALCULATION

N/A

DEEMED O&M COST ADJUSTMENT CALCULATION

N/A

Year savings (using the first equation) and then a “number of years to adjustment” and “savings adjustment” input which would be the (new base to efficient savings)/(existing to efficient savings).

⁶⁸⁷ Average nameplate efficiencies of all Early Replacement qualifying equipment in Ameren PY3-PY4.

⁶⁸⁸ Residential sized units as per Code of Federal Regulations, effective November, 2015 (10 CFR 432(e)).

⁶⁸⁹ Commercial sized units as per Code of Federal Regulations, effective January 2023 (10 CFR 431(d)).

⁶⁹⁰ Commercial sized units as per Code of Federal Regulations, effective January 1, 2023 (10 CFR 431(d)).

⁶⁹¹ Minimum ENERGY STAR efficiency after 2.1.2012.

MEASURE CODE: CI-HVC-FRNC-V14-250101

REVIEW DEADLINE: 1/1/2027

4.4.12 Infrared Heaters

DESCRIPTION

A natural gas-fired radiant infrared heater uses the combustion of natural gas to heat a metal tube or ceramic panel to a very high temperature (typically between 1200 and 5000 degrees Fahrenheit). The high surface temperature causes radiant heat transfer between the heater surface and its surroundings. The surroundings will re-radiate the heat to occupants and release heat through convection to the air, providing a comfortable environment without directly heating air.

Infrared heaters are ideal for space heating applications where there are elevated ceilings with high thermal stratification, spaces with high ventilation or air infiltration rates, or a need for spot heating within an unconditioned or industrial space. Aircraft hangers, warehouses, greenhouses, manufacturing production areas, pools, and loading docks are space types that can be efficiently served by a radiant infrared heater.

This measure was developed to be applicable to the following program types: TOS, NC. If applied to other program types, the measure savings should be verified.

DEFINITION OF EFFICIENT EQUIPMENT

To qualify for this measure the installed equipment must be a natural gas heater with an electric ignition that uses non-conditioned air for combustion. Gross Radiant Coefficient (GRC) is provided by the manufacturer and defined as the ratio of radiant heat output to the natural gas input energy (in Btu).⁶⁹²

DEFINITION OF BASELINE EQUIPMENT

The baseline equipment is a standard natural gas fired warm air heater.

DEEMED LIFETIME OF EFFICIENT EQUIPMENT

The expected measure life is assumed to be 15 years.⁶⁹³

DEEMED MEASURE COST

The incremental capital cost for this measure is \$2.70 per kBtu/hr input capacity.⁶⁹⁴

LOADSHAPE

N/A

COINCIDENCE FACTOR

N/A

Algorithm

CALCULATION OF SAVINGS

ELECTRIC ENERGY SAVINGS

N/A

SUMMER COINCIDENT PEAK DEMAND SAVINGS

N/A

⁶⁹² "AHRI Standard 1330 - 2014 Standard for Performance Rating for Radiant Output of Gas Fired Infrared Heaters". 2014. Air Conditioning, Heating, and Refrigeration Institute. Arlington, VA.

⁶⁹³ 2020 Michigan Energy Measures Database (MEMD). Please see file "mi_master_measure_database_2020-011020_681298_7.xlsx"

⁶⁹⁴ Ibid

FOSSIL FUEL SAVINGS

Natural gas savings for this measure are based on the standard practice of HVAC designers to size a gas-fired radiant infrared heater at a lower input capacity than an equivalent warm air unit heater for an identical application.

$$\Delta\text{Therms} = \text{Therms}(\text{base}) - \text{Therms}(\text{IR})$$

$$\text{Therms}(\text{base}) = \text{Capacity}/\text{RSF} * \text{EFLH}/100,000$$

$$\text{Therms}(\text{IR}) = \text{Capacity} * \text{EFLH}/100,000$$

Where:

Capacity = Input capacity of radiant infrared heater in btu/hr
 = Actual

RSF = Radiation Sizing Factor, dependent on Gross Radiant Coefficient⁶⁹⁵ as listed below:^{696,697}
 If Gross Radiant Coefficient is unavailable, assume RSF = 0.85.

Gross Radiant Coefficient (GRC)	RSF (Radiation Sizing Factor)
GRC < 0.67	0.85
0.67 ≤ GRC	0.70

EFLH = Equivalent Full Load Hours for heating in Existing Buildings or New Construction are provided in section 4.4 HVAC End Use

100,000 = Btu to therm conversion factor

For example: a radiant heater with a natural gas input capacity of 125,000 Btu/hr and a Gross Radiant Coefficient of 0.45 installed in a warehouse in Chicago will save:

$$\Delta\text{Therms} = \text{Therms}(\text{base}) - \text{Therms}(\text{IR})$$

$$\text{Therms}(\text{base}) = 125,000/0.85 * 1286/100,000 = 1891.176 \text{ Therms}$$

$$\text{Therms}(\text{IR}) = 125,000 * 1286/100,000 = 1607.500 \text{ Therms}$$

$$\Delta\text{Therms} = 1891.176 - 1607.500 = 283.676 \text{ Therms}$$

WATER IMPACT DESCRIPTIONS AND CALCULATION

N/A

DEEMED O&M COST ADJUSTMENT CALCULATION

N/A

⁶⁹⁵ GRC should be provided by the manufacturer.

⁶⁹⁶ Radiation Sizing Factor(RSF) value determined by testing as per 2016 ASHRAE® HANDBOOK: Heating, Ventilating, and Air-Conditioning SYSTEMS AND EQUIPMENT, Inch-Pound Edition, Chapter 16, pg. 16.1, "Energy Conservation," 2016, American Society of Heating, Refrigerating, and Air-Conditioning Engineers, Inc. Atlanta, GA.

⁶⁹⁷ "Put Your Infra-Red Knowledge to the Test". Contracting Canada, July - August 2002.

MEASURE CODE: CI-HVC-IRHT-V04-250101

REVIEW DEADLINE: 1/1/2027

4.4.13 Package Terminal Air Conditioner (PTAC) and Package Terminal Heat Pump (PTHP)

DESCRIPTION

A PTAC is a packaged terminal air conditioner that cools and sometimes provides heat through an electric resistance heater (heat strip). A PTHP is a packaged terminal heat pump. A PTHP uses its compressor year round to heat or cool. In warm weather, it efficiently captures heat from inside your building and pumps it outside for cooling. In cool weather, it captures heat from outdoor air and pumps it into your home, adding heat from electric heat strips as necessary to provide heat.

This measure characterizes:

Time of Sale: the purchase and installation of a new efficient PTAC or PTHP.

Early Replacement: the early removal of existing HVAC system from service, prior to its natural end of life, and replacement with a new efficient PTAC or PTHP unit. Savings are calculated between existing unit and efficient unit consumption during the remaining life of the existing unit, and between new baseline unit and efficient unit consumption for the remainder of the measure life.

This measure was developed to be applicable to the following program types: TOS NC, EREP. If applied to other program types, the measure savings should be verified.

DEFINITION OF EFFICIENT EQUIPMENT

In order for this characterization to apply, the efficient equipment is assumed to be PTACs or PTHPs that exceed baseline efficiencies.

DEFINITION OF BASELINE EQUIPMENT

Time of Sale: the baseline condition is equipment that meets the Code energy efficiency requirements (IECC or Code of Federal Regulations whichever is higher) in effect on the date of equipment purchase (if date is unknown, assume current Code minimum).

Early Replacement: the baseline is the existing HVAC equipment for the assumed remaining useful life of the unit and the new baseline as defined above for the remainder of the measure life.

DEEMED LIFETIME OF EFFICIENT EQUIPMENT

The expected measure life is assumed to be 8 years.⁶⁹⁸

Remaining life of existing equipment is assumed to be 3 years.⁶⁹⁹

DEEMED MEASURE COST

Time of Sale: The incremental capital cost for this equipment is estimated to be \$84/ton.⁷⁰⁰

Early Replacement: The measure cost is the full cost of removing the existing unit and installing a new one. The actual program cost should be used. If unknown assume \$1,047 per ton.⁷⁰¹

The assumed deferred cost (after 5 years) of replacing existing equipment with new baseline unit is assumed to be \$1,039 per ton.⁷⁰² This cost should be discounted to present value using the nominal discount rate.

⁶⁹⁸ Based on 2015 DOE Technical Support Document, as recommended in Navigant 'ComEd Effective Useful Life Research Report', May 2018.

⁶⁹⁹ Standard assumption of one third of effective useful life.

⁷⁰⁰ DEER 2008. This assumes that baseline shift from IECC 2012 to IECC 2015 carries the same incremental costs. Values should be verified during evaluation.

⁷⁰¹ Based on DCEO – IL PHA Efficient Living Program data.

⁷⁰² Based on subtracting TOS incremental cost from the DCEO data and incorporating inflation rate of 1.91%.

LOADSHAPE

Loadshape C03 - Commercial Cooling

COINCIDENCE FACTOR

The summer peak coincidence factor for cooling is provided in two different ways below. The first is used to estimate peak savings during the utility peak hour and is most indicative of actual peak benefits, and the second represents the *average* savings over the defined summer peak period and is presented so that savings can be bid into PJM's capacity market. Both values provided are based on analysis of Itron eShape data for Missouri, calibrated to Illinois loads, supplied by Ameren.

$$\begin{aligned} CF_{SSP} &= \text{Summer System Peak Coincidence Factor for Commercial cooling (during system peak hour)} \\ &= 91.3\%^{703} \end{aligned}$$

$$\begin{aligned} CF_{PJM} &= \text{PJM Summer Peak Coincidence Factor for Commercial cooling (average during peak period)} \\ &= 47.8\%^{704} \end{aligned}$$

Algorithm

CALCULATION OF SAVINGS

ELECTRIC ENERGY AND FOSSIL FUEL SAVINGS

Non Fuel Switch Measures

Electric savings for PTACs and PTHPs should be calculated using the following algorithms

Time of Sale:

$$\text{PTAC } \Delta \text{kWh}^{705} = \text{Annual kWh Savings}_{\text{cool}}$$

$$\text{PTHP } \Delta \text{kWh} = \text{Annual kWh Savings}_{\text{cool}} + \text{Annual kWh Savings}_{\text{heat}}$$

$$\text{Annual kWh Savings}_{\text{cool}} = \text{CoolingLoad} * (1/\text{EER}_{\text{base}} - 1/\text{EER}_{\text{ee}})$$

$$\text{Annual kWh Savings}_{\text{heat}} = (\text{HeatLoad} * (1/\text{COP}_{\text{base}} - 1/\text{COP}_{\text{ee}})) / 3.412$$

Early Replacement:

$$\Delta \text{kWh for remaining life of existing unit (1}^{\text{st}} \text{ 3years)} = \text{Annual kWh Savings}_{\text{cool}} + \text{Annual kWh Savings}_{\text{heat}}$$

$$\text{Annual kWh Savings}_{\text{cool}} = \text{CoolingLoad} * (1/\text{EER}_{\text{exist}} - 1/\text{EER}_{\text{ee}})$$

$$\text{Annual kWh Savings}_{\text{heat}} = (\text{HeatLoad} * (1/\text{COP}_{\text{exist}} - 1/\text{COP}_{\text{ee}})) / 3.412$$

$$\Delta \text{kWh for remaining measure life (next 5 years)} = \text{Annual kWh Savings}_{\text{cool}} + \text{Annual kWh Savings}_{\text{heat}}$$

$$\text{Annual kWh Savings}_{\text{cool}} = \text{CoolingLoad} * (1/\text{EER}_{\text{base}} - 1/\text{EER}_{\text{ee}})$$

$$\text{Annual kWh Savings}_{\text{heat}} = (\text{HeatLoad} * (1/\text{COP}_{\text{base}} - 1/\text{COP}_{\text{ee}})) / 3.412$$

Fuel switch measures:

⁷⁰³ Based on analysis of Itron eShape data for Missouri, calibrated to Illinois loads, supplied by Ameren. The AC load during the utility's peak hour is divided by the maximum AC load during the year.

⁷⁰⁴ Based on analysis of Itron eShape data for Missouri, calibrated to Illinois loads, supplied by Ameren. The average AC load over the PJM peak period (1-5pm, M-F, June through August) is divided by the maximum AC load during the year.

⁷⁰⁵ There are no heating efficiency improvements for PTACs since although some do provide heating, it is always through electric resistance and therefore the COP_{base} and COP_{ee} would be 1.0.

Fuel switch measures must produce positive total energy savings (i.e., reduction in Btus at the premises) in order to qualify. This is determined as follows:

$$\begin{aligned} \text{SiteEnergySavings (MMBTUs)} &= \text{FuelSwitchSavings} + \text{NonFuelSwitchSavings} \\ \text{FuelSwitchSavings} &= (\text{GasHeatReplaced} - \text{ElectricHeatConsumed}) \\ \text{NonFuelSwitchSavings} &= \text{CoolingImpact} \end{aligned}$$

Where:

$$\begin{aligned} \text{GasHeatReplaced} &= (\text{HeatLoad} * 1/\text{FossilEff}_{\text{base}}) / 1,000 \\ \text{ElectricHeatConsumed} &= (\text{HeatLoad} * 1/\text{COP}_{\text{ee}}) / 1000 \\ \text{CoolingImpact} &= \text{CoolLoad} * ((1/\text{EER}_{\text{base}}) - (1/\text{EER}_{\text{ee}})) * 3,412/1,000,000 \end{aligned}$$

If SiteEnergySavings calculated above is positive, the measure is eligible.

The appropriate savings claim is dependent on which utilities are supporting the measure as provided in a table below:

Measure supported by:	Electric Utility claims (kWh):	Gas Utility claims (therms):
Electric utility only	SiteEnergySavings * 1,000,000/3,412	N/A
Electric and gas utility (Note utilities may make alternative agreements to how savings are allocated as long as total MMBtu savings remains the same).	%IncentiveElectric * SiteEnergySavings * 1,000,000/3,412	%IncentiveGas * SiteEnergySavings * 10
Gas utility only	N/A	SiteEnergySavings * 10

Note for Early Replacement measures, the efficiency terms of the existing unit should be used for the remaining useful life of the existing equipment and the efficiency terms for a new baseline unit should be used for the remaining years of the measure. See assumptions below.

Where:

$$\begin{aligned} \text{CoolingLoad} &= \text{Annual cooling load for the space being served} \\ &= \text{kBtu/hr}_{\text{cool}} * \text{EFLH}_{\text{cool}} \\ \text{kBtu/hr}_{\text{cool}} &= \text{capacity of the cooling equipment in kBtu per hour (1 ton of cooling capacity equals 12 kBtu/hr).} \\ &= \text{Actual installed} \\ \text{EFLH}_{\text{cool}} &= \text{Equivalent Full Load Hours for cooling in Existing Buildings or New Construction are provided in section 4.4 HVAC End Use:} \\ \text{HeatLoad} &= \text{Annual heat load for the space being served} \\ &= \text{kBtu/hr}_{\text{heat}} * \text{EFLH}_{\text{heat}} \\ \text{kBtu/hr}_{\text{heat}} &= \text{capacity of the heating equipment in kBtu per hour.} \\ &= \text{Actual installed} \end{aligned}$$

$EFLH_{heat}$ = Equivalent Full Load Hours for heating in Existing Buildings or New Construction are provided in section 4.4 HVAC End Use

EER_{exist} = Energy Efficiency Ratio of the existing equipment
 = Actual. If unknown assume 10.2 EER for PTAC and 10.4 EER for PTHP.⁷⁰⁶

EER_{base} = Energy Efficiency Ratio of the baseline equipment; see the table below for values.
 = Based on applicable Code on date of equipment purchase (if unknown assume current Code)

Copy of Table C403.2.3(3): Minimum Efficiency Requirements: Electrically operated packaged terminal air conditioners, packaged terminal heat pumps

Equipment Type	IECC 2015/2018 Minimum Efficiency (baseline effective 1/1/2016)	Federal Regulations Minimum Efficiency (baseline effective 1/1/2019)
PTAC (Cooling mode) Standard Sized	14.0 – (0.300 x Cap/1000) EER	14.0 – (0.300 x Cap/1000) EER Compliance date: 1/1/2017
PTAC (Cooling mode) Non-Standard Size*	10.9 – (0.213 x Cap/1000) EER	10.9 – (0.213 x Cap/1000) EER Compliance date: 10/7/2010
PTHP (Cooling mode) Standard Sized	14.0 – (0.300 x Cap/1000) EER	14.0 – (0.300 x Cap/1000) EER Complainance date: 10/8/2012
PTHP (Cooling mode) Non-Standard Size*	10.8 – (0.213 x Cap/1000) EER	10.8 – (0.213 x Cap/1000) EER Compliance date: 10/7/2010
PTHP (Heating mode) Standard Sized	3.2 – (0.026 x Cap/1000) COP	3.7 – (0.052 x Cap/1000) COP Compliance date: 10/8/2012
PTHP (Heating mode) Non-Standard Size*	2.9 – (0.026 x Cap/1000) COP	2.9 – (0.026 x Cap/1000) COP Compliance date: 10/7/2010

Table notes: “Cap” = The rated cooling capacity of the project in Btu/hr. If the units capacity is less than 7000 Btu/hr, use 7,000 Btu/hr in the calculation. If the unit’s capacity is greater than 15,000 Btu/hr, use 15,000 Btu/hr in the calculations.

* Non-Standard Size apply only to units with existing sleeves less than 16 inches (406mm) in height and less than 42 inches (1067 mm) in width. Replacement unit shall be factory labeled as follows “MANUFACTURED FOR REPLACEMENT APPLICATIONS ONLY; NOT TO BE INSTALLED IN NEW CONSTRUCTION PROJECTS”.

EER_{ee} = Energy Efficiency Ratio of the energy efficient equipment. For air-cooled units < 65 kBtu/hr, if the actual EER_{ee} is unknown, assume the following conversion from SEER to EER for calculation of peak savings⁷⁰⁷: $EER = (-0.02 * SEER^2) + (1.12 * SEER)$
 = Actual installed

3.412 = Btu per Wh.

COP_{exist} = coefficient of performance of the existing equipment
 = Actual. If unknown assume 1.0 COP for PTAC units and 2.9 COP for PTHPs⁷⁰⁸

COP_{base} = coefficient of performance of the baseline equipment; see table above for values.

COP_{ee} = coefficient of performance of the energy efficient equipment.
 = Actual installed.

⁷⁰⁶ Efficiency of existing unit is estimated based on the 2012 IECC building energy code standard sized, and assuming a 1 ton unit; PTAC: $EER = 13.8 - (0.3 * 12,000/1,000) = 10.2$, and PTHP: $EER = 14 - (0.3 * 12,000/1,000) = 10.4$.

⁷⁰⁷ Based on Wassmer, M. (2003). A Component-Based Model for Residential Air Conditioner and Heat Pump Energy Calculations. Masters Thesis, University of Colorado at Boulder. Note this is appropriate for single speed units only.

⁷⁰⁸ Efficiency of existing unit is estimated based on the 2012 IECC building energy code, and assuming a 1 ton unit; $COP = 3.2 - (0.026 * 12,000/1,000) = 2.9$.

FossilEff_{base} = Efficiency of baseline or existing fossil fuel heating system
= Actual or select baseline from applicable measure in Section 4.

Time of Sale (assuming new construction baseline):

For example, a 1 ton PTAC with an efficient EER of 12 in a guest room of a hotel in Rockford with a building permit dated after 1/1/2016 saves:

$$= [(12) * [(1/10.4) - (1/12)] * 1,042]$$
$$= 160 \text{ kWh}$$

Early Replacement (assuming replacement baseline for deferred replacement in 3 years):

For example, a 1 ton PTHP with an efficient EER of 12, COP of 3.0 in a guest room of a hotel in Rockford replaces a PTAC unit (with electric resistance heat) with unknown efficiency.

Δ kWh for remaining life of existing unit (1st 3 years)

$$= (12 * (1/10.2 - 1/12) * 1,042) + (12/3.412 * (1/1.0 - 1/3.0) * 1,758)$$
$$= 184 + 4,122$$
$$= 4,306 \text{ kWh}$$

Δ kWh for remaining measure life (next 5 years)

$$= (12 * (1/10.4 - 1/12) * 1,042) + (12/3.412 * (1/1.0 - 1/3.0) * 1,758)$$
$$= 160 + 4,122$$
$$= 4,282 \text{ kWh}$$

For example, a 1 ton PTHP with an efficient EER of 12, COP of 3.0 in a guest room of a hotel in Rockford in place of a 80% central boiler providing heat and a baseline PTAC.

$$\begin{aligned}
 \text{SiteEnergySavings (MMBTUs)} &= \text{FuelSwitchSavings} + \text{NonFuelSwitchSavings} \\
 \text{FuelSwitchSavings} &= (\text{GasHeatReplaced} - \text{ElectricHeatConsumed}) \\
 \text{NonFuelSwitchSavings} &= \text{CoolingImpact} \\
 \text{GasHeatReplaced} &= (\text{HeatLoad} * 1/\text{FossilEff}_{\text{base}}) / 1,000 \\
 &= (12 * 1,758 * 1/0.8) / 1,000 \\
 &= 26.4 \text{ MMBtu} \\
 \text{ElectricHeatConsumed} &= (\text{HeatLoad} * 1/\text{COP}_{\text{ee}}) / 1,000 \\
 &= (12 * 1,758 * 1/3) / 1,000 \\
 &= 7.0 \text{ MMBtu} \\
 \text{CoolingImpact} &= \text{CoolLoad} * (1/\text{EER}_{\text{base}} - 1/\text{EER}_{\text{ee}}) * 3,412/1,000,000 \\
 &= 12 * 1,042 * (1/10.4 - 1/12) * 3,412/1,000,000 \\
 &= 0.5 \text{ MMBtu} \\
 \\
 \text{SiteEnergySavings (MMBTUs)} &= 26.4 - 7.0 + 0.5 \\
 &= 19.9 \text{ MMBtu} \\
 \\
 \text{If supported by an electric utility: } \Delta\text{kWh} &= \Delta\text{SiteEnergySavings} * 1,000,000 / 3,412 \\
 &= 19.9 * 1,000,000/3,412 \\
 &= 5,832 \text{ kWh}
 \end{aligned}$$

SUMMER COINCIDENT PEAK DEMAND SAVINGS

Time of Sale:

$$\Delta\text{kW} = (\text{kBtu}/\text{hr}_{\text{cool}}) * [(1/\text{EER}_{\text{base}}) - (1/\text{EER}_{\text{ee}})] * \text{CF}$$

Early Replacement:

$$\Delta\text{kW for remaining life of existing unit (1}^{\text{st}} \text{ 3 years)} = (\text{kBtu}/\text{hr}_{\text{cool}}) * [(1/\text{EER}_{\text{exist}}) - (1/\text{EER}_{\text{ee}})] * \text{CF}$$

$$\Delta\text{kW for remaining measure life (next 5 years)} = (\text{kBtu}/\text{hr}_{\text{cool}}) * [(1/\text{EER}_{\text{base}}) - (1/\text{EER}_{\text{ee}})] * \text{CF}$$

Where:

$$\begin{aligned}
 \text{CF}_{\text{SSP}} &= \text{Summer System Peak Coincidence Factor for Commercial cooling (during system peak hour)} \\
 &= 91.3\%^{709}
 \end{aligned}$$

$$\text{CF}_{\text{PJM}} = \text{PJM Summer Peak Coincidence Factor for Commercial cooling (average during peak period)}$$

⁷⁰⁹ Based on analysis of Itron eShape data for Missouri, calibrated to Illinois loads, supplied by Ameren. The AC load during the utility's peak hour is divided by the maximum AC load during the year.

$$= 47.8\%^{710}$$

Time of Sale:

For example, a 1 ton replacement cooling unit with no heating with an efficient EER of 12 with a building permit dated after 1/1/2016 saves:

$$\begin{aligned} \Delta kW_{SSP} &= (12 * (1/10.4 - 1/12)) * 0.913 \\ &= 0.1405 \text{ kW} \end{aligned}$$

For example, a 1 ton PTHP with an efficient EER of 12, COP of 3.0 replacing a PTAC unit with unknown efficiency saves:

ΔkW for remaining life of existing unit (1st 3 years):

$$\begin{aligned} \Delta kW_{SSP} &= 12 * (1/10.2 - 1/12) * 0.913 \\ &= 0.1611 \text{ kW} \end{aligned}$$

ΔkW for remaining measure life (next 5 years):

$$\begin{aligned} \Delta kW_{SSP} &= 12 * (1/10.4 - 1/12) * 0.913 \\ &= 0.1405 \text{ kW} \end{aligned}$$

FOSSIL FUEL SAVINGS

Calculation provided together with Electric Energy Savings above.

WATER IMPACT DESCRIPTIONS AND CALCULATION

N/A

DEEMED O&M COST ADJUSTMENT CALCULATION

N/A

COST EFFECTIVENESS SCREENING AND LOAD REDUCTION FORECASTING WHEN FUEL SWITCHING

This measure can involve fuel switching from fossil fuel to electric.

For the purposes of forecasting load reductions due to fuel switch projects per Section 16-111.5B, changes in site energy use at the customer’s meter (using ΔkWh algorithm below), customer switching estimates, NTG, and any other adjustment factors deemed appropriate, should be used.

The inputs to cost effectiveness screening should reflect the actual impacts on the electric and fuel consumption at the customer meter and, for fuel switching measures, should therefore reflect the decrease in one fuel and increase in another, as opposed to the single savings value calculated in the “Electric and Fossil Fuel Energy Savings” section above. Therefore in addition to the calculation of savings claimed, the following values should be used to assess the cost effectiveness of the measure.

$$\begin{aligned} \Delta \text{Therms} &= [\text{Gas Heat Replaced}] \\ &= (\text{HeatLoad} * 1/\text{FossilEff}_{\text{base}}) / 100 \\ \Delta kWh &= - [\text{Electric Heat Added}] + [\text{CoolingImpact}] \\ &= -((\text{HeatLoad} * 1/\text{COP}_{\text{ee}}) / 3.412) + (\text{CoolLoad} * (1/\text{EER}_{\text{base}} - 1/\text{EER}_{\text{ee}})) \end{aligned}$$

⁷¹⁰ Based on analysis of Itron eShape data for Missouri, calibrated to Illinois loads, supplied by Ameren. The average AC load over the PJM peak period (1-5pm, M-F, June through August) is divided by the maximum AC load during the year.

MEASURE CODE: CI-HVC-PTAC-V13-250101

REVIEW DEADLINE: 1/1/2026

4.4.14 Pipe Insulation

DESCRIPTION

This measure provides rebates for installation of 1” – 4” fiberglass, foam, calcium silicate or other types of insulation with similar insulating properties to existing bare pipe on straight piping as well as other pipe components such as elbows, tees, valves, and flanges for all non-residential installations.

Savings are provided in two forms; default savings estimates on a per linear foot basis and savings calculated with a multitude of varying parameters with the use of an external calculator⁷¹¹. The default savings estimates are provided in the ‘Calculation of Savings’ section below. They provide estimated savings for measure applications with select and default parameters. The external tool, however, allows more flexibility and provides comprehensive analysis to pipe insulation projects, accounting for all on-site variables.

Default per linear foot savings estimates are provided for both exposed indoor or above ground outdoor piping distributing fluid in the following system types (natural gas fired systems only):

- Hydronic heating systems (with or without outdoor reset controls), including:
 - boiler systems that do not circulate water around a central loop and operate upon demand from a thermostat (“non-recirculation”)
 - systems that recirculate during heating season only (“Recirculation – heating season only”)
 - systems recirculating year-round (“Recirculation – year-round”)
- Domestic hot water
- Low and high-pressure steam systems
 - non-recirculation
 - recirculation - heating season only
 - recirculation - year round

With the use of the external tool to account for varying parameter inputs, savings are calculated using the “Pipe Insulation” calculator available on the Nicor Gas website at: https://www.nicorgas.com/emerging_savings_approached_through_the_following_inputs:

- Pipe Material: Copper, Steel, Stainless Steel
- Pipe Location: Indoor (Heated, Semi-Heated,⁷¹² Unheated, Unspecified) or Outdoor
- Application: Hot Water Space Heating, Steam (5, 15, 40, 65, 100, 150 psi) for various system types detailed in the subsequent system type list below
- Thermal Regain Factor (based on pipe location)
- Building Type ⁷¹³
- Nominal Pipe Size (inches)
- Insulation Thickness (inches): 1”-4”, specified in ½” increments ⁷¹⁴
- Hot Water/Steam Boiler Efficiency (%): 75%-90%, specified in 2.5% increments
- Climate Zone: Rockford, Chicago, Springfield, Belleville, Marion
- Length of Installed Pipe (feet)
- Number of Elbows, Tees, Flanges, and/or Valves ⁷¹⁵

⁷¹¹ Please see; ‘C&I Pipe Insulation Calculator Access.docx’ for directions on accessing the external calculator. The use of other comparable external calculators are allowed if the functionality mirrors the savings approach detailed in this characterization.

⁷¹² Unconditioned space with heat transfer to conditioned space (e.g. boiler room, ceiling plenum, basement, crawlspace, wall, etc.).

⁷¹³ Comprehensive list of building types available in Section 4.4, HVAC End Use of IL TRM.

⁷¹⁴ For insulation thicknesses greater than 4”, savings can be claimed based on 4” insulation thickness.

⁷¹⁵ Equivalent length of elbows and tees is based on methodology described in ANSI/ASME B36.19. Equivalent length of flanges and valves is based on methodology described in ATSM Standard C1129-12.

Process piping can also use the algorithms provided but requires custom entry of hours.

For new construction applications, minimum qualifying nominal pipe diameter is 1". Piping must have at least 1" of insulation and outdoor piping must include an all-weather protective jacket. New advanced insulating materials may be thinner, and savings can be calculated with 3E Plus v4.1.

The relevant code of compliance should be followed for direction on minimum permitted insulation thickness for a nominal pipe diameter. As per the International Energy Conservation Code (IECC) 2021, the minimum permitted insulation thickness is 1" for installations pertaining to new construction or major renovation heating HVAC applications⁷¹⁶. However, there are exceptions based on Fluid Operating Temperature Range, Insulation thermal conductivity range, install locations and pipe sizes –indicating the minimum insulation thickness required for parameters described in the column headers presented in the table below.

Fluid Operating Temperature Range and Usage (°F)	Insulation Conductivity		Nominal Pipe or Tube Size (inches)				
	Conductivity Btu.in/(h.ft ² .°F)	Mean Rating Temperature, °F	<1	1 to <1.5	1.5 to <4	4 to <8	≥8
>350	0.32 - 0.34	250	4.5	5.0	5.0	5.0	5.0
251 - 350	0.29 - 0.32	200	3.0	4.0	4.5	4.5	4.5
201 - 250	0.27 - 0.30	150	2.5	2.5	2.5	3.0	3.0
141 - 200	0.25 - 0.29	125	1.5	1.5	2.0	2.0	2.0
105 - 140	0.21 - 0.28	100	1.0	1.0	1.5	1.5	1.5
40 -60	0.21 - 0.27	75	0.5	0.5	1.0	1.0	1.0
<40	0.20 - 0.26	50	0.5	1.0	1.0	1.0	1.5

Note – The above table is not representative of the applicability of the workpaper measure and does not reflect any limitations in the web-based calculator. This is merely the requirements cited by the IECC 2018 code for pipe insulation.

This measure was developed to be applicable to the following program types: RF, DI

If applied to other program types, the measure savings should be verified.

DEFINITION OF EFFICIENT EQUIPMENT

The efficient case is installing pipe wrap insulation to a length of pipe. Indoor piping must have at least 1" of insulation (or equivalent R-value) and outdoor piping must have at least 2" of insulation (or equivalent R-value) and include an all-weather protective jacket. Minimum qualifying pipe diameter is 1." Insulation must be continuous and contiguous over fittings that directly connect to straight pipe, including elbows and tees.⁷¹⁷

DEFINITION OF BASELINE EQUIPMENT

The base case for savings estimates is a bare pipe. Pipes are required by new construction code to be insulated but are still commonly found uninsulated in older commercial buildings.

DEEMED LIFETIME OF EFFICIENT EQUIPMENT

The measure life is assumed to be 15 years.⁷¹⁸

⁷¹⁶ International Energy Conservation Code, 2018; Section C403.11.3 Piping Insulation (Mandatory), Table C403.11.3, Page C-69.

⁷¹⁷ ASHRAE Handbook—Fundamentals, 23.14; Hart, G., "Saving energy by insulating pipe components on steam and hot water distribution systems", ASHRAE Journal, October 2011.

⁷¹⁸ Measure Life Report, Residential and Commercial/Industrial Lighting and HVAC Measures, GDS Associates, June 2007.

DEEMED MEASURE COST

Actual costs should be used if known. Otherwise, the deemed measure costs below based on RS Means⁷¹⁹ pricing reference materials may be used.⁷²⁰ The following table summarizes the estimated costs for this measure per foot of insulation added and include installation costs:

Insulation Thickness				
	1 Inch	1.5 Inches	2 Inches	2.5 Inches
Pipe- RS Means #	220719.10.5140	220719.10.4900	220719.10.4900	Extrapolated
Jacket- RS Means #	220719.30.0152 & 220719.40.0240	220719.30.0140 & 220719.40.0140	220719.30.0140 & 220719.40.0140	220719.30.0140 & 220719.40.0140
Pipe Insulation Type	Calcium Silicate	Calcium Silicate	Calcium Silicate	Calcium Silicate
Jacket Type (Indoor)	PVC	PVC	PVC	PVC
Jacket Type (Outdoor)	Aluminum	Aluminum	Aluminum	Aluminum
Insulation Cost per foot [1]	\$11.45	\$15.73	\$20.23	\$24.58
Jacket Cost per foot (Indoor) [2]	\$4.90	\$6.70	\$6.70	\$6.70
Jacket Cost per foot (Outdoor) [3]	\$6.75	\$9.27	\$9.27	\$9.27
Total Cost per foot (Indoor) = [1+2]	\$16.35	\$22.43	\$26.93	\$31.28
Total Cost per foot (Outdoor) = [1+3]	\$18.20	\$25.00	\$29.50	\$33.85

Insulation Thickness (continued)			
	3 Inches	3.5 Inches	4 Inches
Pipe- RS Means #	220719.10.4900	Extrapolated	Extrapolated
Jacket- RS Means #	220719.30.0140 & 220719.40.0140	220719.30.0140 & 220719.40.0140	220719.30.0140 & 220719.40.0140
Pipe Insulation Type	Calcium Silicate	Calcium Silicate	Calcium Silicate
Jacket Type (Indoor)	PVC	PVC	PVC
Jacket Type (Outdoor)	Aluminum	Aluminum	Aluminum
Insulation Cost per foot [1]	\$28.92	\$33.32	\$37.70
Jacket Cost per foot (Indoor) [2]	\$6.70	\$6.70	\$6.70
Jacket Cost per foot (Outdoor) [3]	\$9.27	\$9.27	\$9.27
Total Cost per foot (Indoor) = [1+2]	\$35.62	\$40.02	\$44.40
Total Cost per foot (Outdoor) = [1+3]	\$38.19	\$42.59	\$46.97

LOADSHAPE

N/A

COINCIDENCE FACTOR

N/A

⁷¹⁹ RS Means 2008. Mechanical Cost Data, pages 106 to 119

⁷²⁰ RS Means 2010: “for fittings, add 3 linear feet for each fitting plus 4 linear feet for each flange of the fitting”

Algorithm

CALCULATION OF SAVINGS

ELECTRIC ENERGY SAVINGS

N/A

SUMMER COINCIDENT PEAK DEMAND SAVINGS

N/A

FOSSIL FUEL SAVINGS

$$\begin{aligned} \Delta\text{therms per foot}^{721} &= [((Q_{\text{base}} - Q_{\text{eff}}) * \text{EFLH}) / (100,000 * \eta_{\text{Boiler}})] * \text{TRF} \\ &= [\text{Modeled or provided by tables below}] * \text{TRF} \\ \Delta\text{therms} &= (L_{\text{sp}} + L_{\text{oc},i}) * \Delta\text{therms per foot} \end{aligned}$$

Where:

EFLH = Equivalent Full Load Hours for Heating in Existing Buildings or New Construction
 = Actual or defaults by building type provided in Section 4.4, HVAC end use
 For year-round recirculation or domestic hot water:
 = 8,766

For heating season recirculation, hours with the outside air temperature below 55°F:

Zone	Hours
Zone 1 (Rockford)	5,039
Zone 2 (Chicago)	4,963
Zone 3 (Springfield)	4,495
Zone 4 (Belleville/	4,021
Zone 5 (Marion)	4,150

Q_{base} = Heat Loss from Bare Pipe (Btu/hr/ft)
 = Calculated where possible using 3E Plusv4.1 software. For defaults see table below

Q_{eff} = Heat Loss from Insulated Pipe (Btu/hr/ft)
 = Calculated where possible using 3E Plusv4.1 software. For defaults see table below

100,000 = conversion factor (1 therm = 100,000 Btu)

η_{Boiler} = Efficiency of the boiler being used to generate the hot water or steam in the pipe
 = Actual or if unknown use default values given below:
 = 81.9% for water boilers ⁷²²
 = 80.7% for steam boilers, except multifamily low-pressure ⁷²³

⁷²¹This value comes from the reference table “Savings Summary by Building Type and System Type.” The formula and the input tables in this section document assumptions used in calculation spreadsheet “Pipe Insulation Savings 2013-11-12.xlsx”.

⁷²² Average efficiencies of units from the California Energy Commission (CEC).

⁷²³ Ibid.

= 64.8% for multifamily low-pressure steam boilers ⁷²⁴

TRF = Thermal Regain Factor for pipe location and use, see table below. The Custom TRF option may be used on any pipe location, including pipe locations with deemed TRFs specifically listed in the table below, if supporting justification and calculations for the Custom TRF are provided.

May vary seasonally such as: TRF[summer] * summer hours + TRF[winter] * winter hours where TRF values reflecting summer and winter conditions are apportioned by the hours for those conditions. TRF may also be adjusted by building specific balance point temperature (BPT) and operating hours above and below that BPT. ⁷²⁵

Pipe Location	Assumed Regain	TRF, Thermal Regain Factor
Outdoor	0%	1.0
Indoor, conditioned space during the heating season, 55°F BPT	85%	0.15
Indoor, conditioned space, not during the heating season, 55°F BPT	0%	1.0
Indoor, conditioned, annual use (e.g., hot water or process loads), 55°F BPT	45%	0.55
Indoor, semi- conditioned, (unconditioned space, with heat transfer to conditioned space. E.g., boiler room, ceiling plenum, basement, crawlspace, wall), during the heating season, 55°F BPT	30%	0.70
Indoor, semi-conditioned, not during the heating season, 55°F BPT	0%	1.0
Indoor, semi-conditioned, annual use, 55°F BPT	16%	0.84
Indoor, unconditioned spaces, (no heat transfer to conditioned space)	0%	1.0
Location not specified - Commercial	23%	0.77
Location not specified – Industrial	16%	0.84
Custom	Custom	1 – assumed regain

L_{sp} = Length of straight pipe to be insulated (linear foot)
 = actual installed (linear foot)

L_{oc,l} = Total equivalent length of the other components (valves and tees) of pipe to be insulated
 = Actual installed (linear foot). See table “Equivalent Length of Other Components – Elbows and Tees” for equivalent lengths.

The heat loss estimates (Q_{base} and Q_{eff}) were developed using the 3E Plus v4.1 software program.⁷²⁶ The energy savings analysis is based on adding 1-inch (indoor) or 2-inch (outdoor) thick insulation around bare pipe. The thermal conductivity of pipe insulation varies by material and temperature rating; to obtain a typical value, a range of

⁷²⁴ Katrakis, J. and T.S. Zawacki. “Field-Measured Seasonal Efficiency of Intermediate-sized Low-Pressure Steam Boilers”. ASHRAE V99, pt. 2, 1993.

⁷²⁵ Zimmerman, Cliff, Franklin Energy, “Thermal Regain Factor_4-30-14.docx”, 2014. Based on climate zone 2. Note ‘Location not specified – Commercial’ assumes semi-conditioned spaces with 50% pipes providing space heating and 50% providing DHW. ‘Location not specified – Commercial’ assumes semi-conditioned annual usage.

⁷²⁶ 3E Plus is a heat loss calculation software provided by the NAIMA (North American Insulation Manufacturer Association).

materials allowed for this measure were averaged. For insulation materials not in the table below, use 3E Plusv4.0 software to calculate Q_{base} and Q_{eff} .

Insulation Type	Conductivity (Btu.in / hr.ft ² .°F @ 75F)	Max temp (°F)
Polyethylene foam	0.25	200
Flexible polyurethane-based foam	0.27	200
Fiberglass	0.31	250
Melamine foam	0.26	350
Flexible silicon foam	0.40	392
Calcium silicate	0.40	1200
Cellular glass	0.31	400
Average conductivity of all these materials (Btu.in / hr.ft ² .°F @ 75°F)	0.31	

The pipe fluid temperature assumption used depends upon both the system type and whether there are outdoor reset controls:

System Type	Fluid temperature assumption (°F)
Hot Water space heating with outdoor reset - Non recirculation	145
Hot Water space heating without outdoor reset - Non recirculation	170
Hot Water space heating with outdoor reset – Recirculation heating season only	145
Hot Water space heating without outdoor reset – Recirculation heating season only	170
Hot Water space heating with outdoor reset – Recirculation year-round	130
Hot Water space heating without outdoor reset – Recirculation year-round	170
Domestic Hot Water	125
5 psi Steam (low pressure)	225
15 psi Steam (low pressure)	250
40 psi Steam (low pressure)	287
65 psi Steam (high pressure)	312
100 psi Steam (high pressure)	338
150 psi Steam (high pressure)	365

For Example, a DHW water boiler in an unconditioned indoor space with 100 feet of 4” steel pipe, and 20 each of pipe elbows, tees, flanges, and valves installing 2.5” of polyethylene foam would save:

$$\begin{aligned} \Delta \text{therms per foot} &= (((Q_{base} - Q_{eff}) * EFLH) / (100,000 * n_{Boiler})) * TRF \\ &= (((0.8 * 252.6) - (0.25 * 252.6) * 8,766) / (100,000 * 81.9\%)) * 0.77 \\ &= 11.4 \text{ therms per foot} \\ \Delta \text{therms} &= (L_{sp} + L_{oci}) * \Delta \text{therms per foot} \\ &= (100 + 152.6) * 11.4 \\ &= 2,892.3 \text{ therms} \end{aligned}$$

Example System Types	Indoor Insulation, Hot Water	Indoor Insulation, 5 psi Steam	Indoor Insulation, 65 psi Steam	Domestic Hot Water	Outdoor Insulation, Hot Water	Outdoor Insulation, 5 psi Steam	Outdoor Insulation, 65 psi Steam
Insulation thickness (inch)	1	2	2.5	1	3	3.5	4
Temperature, Fluid in Pipe (°F)	170 (w/o reset) 145 (w/ reset heat) 130 (w/reset year)	225	312	125	170 (w/o reset) 145 (w/ reset heat) 130 (w/reset year)	225	312
Climate Zone	Climate Zone 2: Chicago						
Building Type	Office – Mid Rise						
Operating Time (hrs/yr)	1,629 (non-recirc) 4,963 (recirc heating season) 8,766 (recirc year-round)						
Ambient Temperature (°F) ⁷²⁷	75	75	75	75	48.6	48.6	48.6
Wind speed (mph) ⁷²⁸	0	0	0	0	5.0	5.0	5.0
Boiler / Water Heater efficiency	75%	80%	85%	67%	80%	85%	90%
Pipe parameters							
Pipe Location	Indoor Heated	Indoor Semi-heated	Indoor Unheated	n/a	Outdoor		
Pipe material	Copper	Steel	Stainless Steel	Copper	Copper	Steel	Stainless Steel
Length of Pipe (ft)	100						
Pipe size for Heat Loss Calc	2"	2"	2"	2"	2"	2"	2"
Outer Diameter, Pipe, actual	2.38"	2.38"	2.38"	2.38"	2.38"	2.38"	2.38"
Heat Loss, Bare Pipe (from 3EPlus) (Btu/hr-ft)	113.5 (w/o reset) 77.8 (w/ reset heat) 58 (w/reset year)	232.2	286.3	52	460.2 (w/o reset) 363.4 (w/ reset heat) 306 (w/reset year)	709.5	942.2
Insulation parameters							
Average Heat Loss, Insulation (from 3EPlus) (Btu/hr-ft)	21.6 (w/o reset) 15.8 (w/ reset heat) 12.4 (w/reset year)	22.6	31.8	13.25	15.2 (w/o reset) 12.1 (w/ reset heat) 10.2 (w/reset year)	20.4	28.2

⁷²⁷ DOE Weather Data, TMY3 (Typical Meteorological Year), developed by NREL for the average ambient temperature for Aurora, IL.

⁷²⁸ DOE Weather Data, TMY3 (Typical Meteorological Year), developed by NREL for the average ambient temperature for Aurora, IL.

Example System Types	Indoor Insulation, Hot Water	Indoor Insulation, 5 psi Steam	Indoor Insulation, 65 psi Steam	Domestic Hot Water	Outdoor Insulation, Hot Water	Outdoor Insulation, 5 psi Steam	Outdoor Insulation, 65 psi Steam
Annual Energy Savings/ft							
Annual Gas Use, Base Case (therms/yr/ft)	2.46 (w/o reset) 5.15 (w/ reset heat) 6.78 (w/reset year)	4.73 (non recirc) 14.4 (recirc heat) 25.4 (recirc year)	5.5 (non recirc) 16.7 (recirc heat) 29.5 (recirc year)	6.76	9.37 (w/o reset) 22.5 (w/ reset heat) 33.5 (w/reset year)	13.6 (non recirc) 41.4 (recirc heat) 73.2 (recirc year)	17.1 (non recirc) 52.0 (recirc heat) 91.8 (recirc year)
Annual Gas Use, Measure case (therms/yr/ft)	0.46 (w/o reset) 1.05 (w/ reset heat) 1.48 (w/reset year)	0.43 (non recirc) 1.4 (recirc heat) 2.4 (recirc year)	0.6 (non recirc) 1.8 (recirc heat) 3.2 (recirc year)	1.73	0.3 (w/o reset) 0.7 (w/ reset heat) 1.1 (w/reset year)	0.4 (non recirc) 1.2 (recirc heat) 2.1 (recirc year)	0.6 (non recirc) 1.6 (recirc heat) 2.8 (recirc year)
Annual Gas Savings (therms/yr/ft)	2.0 (w/o reset) 4.1 (w/ reset heat) 5.3 (w/reset year)	4.3 (non recirc) 13.0 (recirc heat) 23.0 (recirc year)	4.9(non recirc) 14.9 (recirc heat) 26.3 (recirc year)	5.02	9.1 (w/o reset) 21.8 (w/ reset heat) 32.4 (w/reset year)	13.2 (non recirc) 40.2 (recirc heat) 71.1 (recirc year)	16.5 (non recirc) 50.4 (recirc heat) 89 (recirc year)
Elbows, Tees, Flanges, & Valves							
Number of Elbows	5	10	20	n/a	5	10	20
Number of Tees	5	10	20	n/a	5	10	20
Number of Flanges	5	10	20	n/a	5	10	20
Number of Valves	5	10	20	n/a	5	10	20
Annual Energy Savings							
Total Gas Savings (therms/yr)	39 (w/o reset) 80 (w/ reset heat) 104 (w/reset year)	478 (non recirc) 1,456 (recirc heat) 2,571 (recirc year)	1,072 (non recirc) 3,267 (recirc heat) 5,770 (recirc year)	502	930 (w/o reset) 2,832 (w/ reset heat) 4,211 (w/reset year)	2,112 (non recirc) 6,434 (recirc heat) 11,364 (recirc year)	3,635 (non recirc) 11,074 (recirc heat) 19,560 (recirc year)

Heat = heating season only, year = year round

Values below must be multiplied by the appropriate Thermal Regain Factor (TRF). All variables were the same except for hours of operation in the calculation of the default savings per foot for the various building types and applications as presented in the table below:

**Savings Summary for Indoor pipe insulation by System Type and Building Type (Δtherms per foot)
(continues for 3.5 pages)**

Location	System Type	Building Type	Annual therm Savings per linear foot (therm /ft) (2" pipe / 1" insulation for hot water, 2" insulation for steam)				
			Zone 1 (Rockford)	Zone 2 (Chicago)	Zone 3 (Springfield)	Zone 4 (Belleville)	Zone 5 (Marion)
Indoor	Hot Water Space Heating with outdoor reset – non-recirculation	Assembly	1.32	1.36	1.21	0.81	1.24
		Assisted Living	1.25	1.22	1.07	0.79	0.95
		College	1.13	1.06	0.95	0.53	0.63
		Convenience Store	1.10	1.01	0.90	0.65	0.72
		Elementary School	1.32	1.29	1.13	0.78	0.95
		Garage	0.73	0.72	0.63	0.50	0.56
		Grocery	1.19	1.19	1.04	0.65	0.78
		Healthcare Clinic	1.17	1.20	1.05	0.71	0.75
		High School	1.37	1.38	1.23	0.88	1.03
		Hospital - CAV no econ	1.31	1.35	1.15	0.99	1.12
		Hospital - CAV econ	1.33	1.37	1.17	1.01	1.15
		Hospital - VAV econ	0.54	0.51	0.39	0.23	0.25
		Hospital - FCU	0.98	1.12	0.91	1.07	1.44
		Hotel/Motel	1.31	1.27	1.14	0.78	0.96
		Hotel/Motel - Common	1.19	1.21	1.15	0.93	0.98
		Hotel/Motel - Guest	1.30	1.26	1.13	0.75	0.93
		Manufacturing Facility	0.78	0.75	0.70	0.42	0.47
		MF - High Rise	1.13	1.12	1.02	0.87	0.87
		MF - High Rise - Common	1.35	1.31	1.17	0.81	1.04
		MF - High Rise - Residential	1.09	1.08	0.99	0.85	0.83
		MF - Mid Rise	1.23	1.25	1.07	0.79	0.90
		Movie Theater	1.35	1.33	1.24	0.94	1.12
		Office - High Rise - CAV no econ	1.50	1.52	1.38	0.93	1.01
		Office - High Rise - CAV econ	1.55	1.58	1.45	1.00	1.10
		Office - High Rise - VAV econ	1.13	1.15	0.95	0.56	0.63
		Office - High Rise - FCU	0.83	0.82	0.71	0.37	0.39
		Office - Low Rise	1.06	1.06	0.84	0.51	0.59
		Office - Mid Rise	1.17	1.18	0.99	0.63	0.70
		Religious Building	1.19	1.11	1.07	0.78	0.89
		Restaurant	1.00	1.00	0.90	0.68	0.81
Retail - Department Store	1.03	0.95	0.89	0.58	0.66		
Retail - Strip Mall	0.99	0.91	0.81	0.56	0.60		
Warehouse	1.08	1.01	1.04	0.65	0.80		
Unknown	1.15	1.14	1.01	0.73	0.84		

			Annual therm Savings per linear foot (therm /ft) (2" pipe / 1" insulation for hot water, 2" insulation for steam)				
Location	System Type	Building Type	Zone 1 (Rockford)	Zone 2 (Chicago)	Zone 3 (Springfield)	Zone 4 (Belleville)	Zone 5 (Marion)
Indoor	Hot Water Space Heating without outdoor reset – non-recirculation	Assembly	1.96	2.00	1.79	1.19	1.83
		Assisted Living	1.84	1.80	1.58	1.16	1.40
		College	1.67	1.56	1.40	0.78	0.93
		Convenience Store	1.62	1.50	1.33	0.95	1.06
		Elementary School	1.95	1.90	1.68	1.16	1.40
		Garage	1.08	1.06	0.93	0.74	0.82
		Grocery	1.76	1.75	1.54	0.96	1.15
		Healthcare Clinic	1.73	1.77	1.55	1.05	1.11
		High School	2.02	2.03	1.82	1.30	1.52
		Hospital - CAV no econ	1.93	1.99	1.69	1.46	1.65
		Hospital - CAV econ	1.96	2.03	1.73	1.50	1.70
		Hospital - VAV econ	0.80	0.76	0.57	0.34	0.37
		Hospital - FCU	1.45	1.65	1.35	1.58	2.13
		Hotel/Motel	1.93	1.87	1.69	1.16	1.41
		Hotel/Motel - Common	1.75	1.78	1.69	1.38	1.45
		Hotel/Motel - Guest	1.92	1.86	1.66	1.11	1.37
		Manufacturing Facility	1.15	1.11	1.03	0.62	0.69
		MF - High Rise	1.67	1.65	1.50	1.28	1.28
		MF - High Rise - Common	1.99	1.93	1.73	1.19	1.54
		MF - High Rise - Residential	1.61	1.60	1.46	1.26	1.23
		MF - Mid Rise	1.82	1.84	1.59	1.17	1.33
		Movie Theater	1.99	1.96	1.83	1.39	1.66
		Office - High Rise - CAV no econ	2.21	2.24	2.04	1.37	1.49
		Office - High Rise - CAV econ	2.29	2.33	2.14	1.48	1.63
		Office - High Rise - VAV econ	1.67	1.70	1.40	0.83	0.93
		Office - High Rise - FCU	1.22	1.21	1.04	0.55	0.58
		Office - Low Rise	1.56	1.56	1.24	0.76	0.87
		Office - Mid Rise	1.73	1.74	1.47	0.94	1.04
		Religious Building	1.75	1.65	1.58	1.15	1.32
	Restaurant	1.48	1.48	1.33	1.01	1.19	
	Retail - Department Store	1.52	1.40	1.31	0.85	0.97	
	Retail - Strip Mall	1.46	1.35	1.19	0.82	0.89	
	Warehouse	1.59	1.49	1.53	0.96	1.18	
Unknown	1.70	1.68	1.50	1.07	1.25		
Hot Water with outdoor reset	All buildings, Recirculation heating season only (Hours below 55F)	3.73	3.68	3.33	2.98	3.08	
Hot Water w/o outdoor reset	All buildings, Recirculation heating season only (Hours below 55F)	5.51	5.43	4.92	4.40	4.54	
Hot Water with outdoor reset	All buildings, Recirculation year round (All hours)	4.79	4.79	4.79	4.79	4.79	
Hot Water w/o outdoor reset	All buildings, Recirculation year round (All hours)	9.58	9.58	9.58	9.58	9.58	
Domestic Hot Water	DHW circulation loop	5.02	5.02	5.02	5.02	5.02	

Location	System Type	Building Type	Annual therm Savings per linear foot (therm /ft) (2" pipe / 1" insulation for hot water, 2" insulation for steam)				
			Zone 1 (Rockford)	Zone 2 (Chicago)	Zone 3 (Springfield)	Zone 4 (Belleville)	Zone 5 (Marion)
	LP Steam – non-recirculation	Assembly	4.25	4.36	3.89	2.59	3.97
		Assisted Living	4.01	3.92	3.44	2.53	3.04
		College	3.64	3.40	3.04	1.69	2.02
		Convenience Store	3.52	3.26	2.89	2.07	2.32
		Elementary School	4.24	4.13	3.64	2.52	3.05
		Garage	2.34	2.31	2.03	1.62	1.79
		Grocery	3.83	3.81	3.34	2.08	2.49
		Healthcare Clinic	3.76	3.85	3.36	2.29	2.42
		High School	4.39	4.42	3.96	2.82	3.30
		Hospital - CAV no econ	4.20	4.33	3.69	3.17	3.60
		Hospital - CAV econ	4.25	4.41	3.76	3.26	3.70
		Hospital - VAV econ	1.74	1.65	1.24	0.75	0.81
		Hospital - FCU	3.15	3.60	2.93	3.44	4.63
		Hotel/Motel	4.19	4.07	3.67	2.51	3.07
		Hotel/Motel - Common	3.81	3.87	3.68	3.00	3.15
		Hotel/Motel - Guest	4.18	4.05	3.62	2.42	2.98
		Manufacturing Facility	2.49	2.41	2.23	1.35	1.51
		MF - High Rise	4.52	4.46	4.07	3.46	3.47
		MF - High Rise - Common	5.38	5.22	4.68	3.23	4.17
		MF - High Rise - Residential	4.37	4.34	3.94	3.41	3.33
		MF - Mid Rise	4.94	4.99	4.30	3.16	3.60
		Movie Theater	4.33	4.26	3.98	3.03	3.61
		Office - High Rise - CAV no econ	4.81	4.88	4.45	2.98	3.24
		Office - High Rise - CAV econ	4.97	5.07	4.66	3.21	3.54
		Office - High Rise - VAV econ	3.64	3.71	3.06	1.81	2.01
		Office - High Rise - FCU	2.66	2.62	2.27	1.20	1.26
		Office - Low Rise	3.40	3.39	2.69	1.65	1.89
		Office - Mid Rise	3.77	3.78	3.19	2.03	2.26
		Religious Building	3.82	3.58	3.43	2.51	2.87
		Restaurant	3.21	3.22	2.89	2.19	2.60
	Retail - Department Store	3.31	3.04	2.86	1.86	2.12	
	Retail - Strip Mall	3.17	2.94	2.59	1.79	1.93	
	Warehouse	3.46	3.23	3.33	2.08	2.56	
	Unknown	3.70	3.66	3.26	2.34	2.71	
	LP Steam	All buildings, Recirculation heating season only (Hours below 55F)	11.99	11.81	10.70	9.57	9.88
	LP Steam	All buildings, Recirculation year round (All hours)	20.84	20.84	20.84	20.84	20.84

Location	System Type	Building Type	Annual therm Savings per linear foot (therm /ft) (2" pipe / 1" insulation for hot water, 2" insulation for steam)				
			Zone 1 (Rockford)	Zone 2 (Chicago)	Zone 3 (Springfield)	Zone 4 (Belleville)	Zone 5 (Marion)
	HP Steam – non-recirculation	Assembly	8.02	8.22	7.34	4.89	7.49
		Assisted Living	7.56	7.39	6.49	4.77	5.73
		College	6.87	6.42	5.73	3.18	3.81
		Convenience Store	6.65	6.14	5.45	3.91	4.37
		Elementary School	8.00	7.79	6.87	4.75	5.76
		Garage	4.42	4.35	3.82	3.05	3.38
		Grocery	7.22	7.19	6.30	3.93	4.70
		Healthcare Clinic	7.09	7.27	6.35	4.32	4.57
		High School	8.28	8.34	7.48	5.33	6.23
		Hospital - CAV no econ	7.92	8.16	6.95	5.98	6.79
		Hospital - CAV econ	8.03	8.32	7.09	6.14	6.98
		Hospital - VAV econ	3.28	3.12	2.35	1.41	1.53
		Hospital - FCU	5.95	6.79	5.53	6.50	8.73
		Hotel/Motel	7.91	7.69	6.93	4.74	5.79
		Hotel/Motel - Common	7.18	7.30	6.95	5.65	5.94
		Hotel/Motel - Guest	7.89	7.64	6.83	4.57	5.62
		Manufacturing Facility	4.70	4.55	4.22	2.55	2.84
		MF - High Rise	6.85	6.76	6.16	5.25	5.26
		MF - High Rise - Common	8.15	7.91	7.09	4.89	6.31
		MF - High Rise - Residential	6.62	6.57	5.97	5.17	5.04
		MF - Mid Rise	7.48	7.57	6.51	4.79	5.46
		Movie Theater	8.16	8.04	7.52	5.71	6.80
		Office - High Rise - CAV no econ	9.07	9.20	8.39	5.62	6.12
		Office - High Rise - CAV econ	9.38	9.57	8.80	6.06	6.67
		Office - High Rise - VAV econ	6.86	6.99	5.76	3.41	3.80
		Office - High Rise - FCU	5.02	4.95	4.27	2.27	2.38
		Office - Low Rise	6.41	6.40	5.08	3.11	3.56
		Office - Mid Rise	7.12	7.12	6.03	3.84	4.27
		Religious Building	7.20	6.75	6.46	4.73	5.41
		Restaurant	6.06	6.08	5.46	4.13	4.90
	Retail - Department Store	6.25	5.74	5.39	3.51	4.00	
	Retail - Strip Mall	5.98	5.54	4.89	3.37	3.63	
	Warehouse	6.53	6.09	6.29	3.93	4.84	
	Unknown	6.97	6.91	6.14	4.41	5.11	
	HP Steam	All buildings, Recirculation heating season only (Hours below 55F)	22.62	22.28	20.18	18.05	18.63
	HP Steam	All buildings, Recirculation year round (All hours)	39.32	39.32	39.32	39.32	39.32

**Savings Summary for Outdoor pipe insulation by System Type and Building Type (Δ therms per foot)
(continues for 3.5 pages)**

Location	System Type	Building Type	Annual therm Savings per linear foot (therm /ft) (2" pipe / 1" insulation for hot water, 2" insulation for steam)				
			Zone 1 (Rockford)	Zone 2 (Chicago)	Zone 3 (Springfield)	Zone 4 (Belleville)	Zone 5 (Marion)
Outdoor	Hot Water Space Heating with outdoor reset – non-recirculation	Assembly	5.61	5.75	5.14	3.42	5.24
		Assisted Living	5.28	5.17	4.54	3.34	4.01
		College	4.80	4.49	4.00	2.23	2.66
		Convenience Store	4.65	4.29	3.81	2.74	3.06
		Elementary School	5.59	5.45	4.81	3.32	4.03
		Garage	3.09	3.04	2.67	2.13	2.36
		Grocery	5.05	5.03	4.41	2.75	3.29
		Healthcare Clinic	4.96	5.08	4.44	3.03	3.20
		High School	5.79	5.83	5.23	3.72	4.36
		Hospital - CAV no econ	5.54	5.71	4.86	4.18	4.74
		Hospital - CAV econ	5.62	5.82	4.96	4.30	4.88
		Hospital - VAV econ	2.29	2.18	1.64	0.98	1.07
		Hospital - FCU	4.16	4.75	3.87	4.54	6.11
		Hotel/Motel	5.53	5.37	4.85	3.32	4.05
		Hotel/Motel - Common	5.02	5.11	4.86	3.95	4.15
		Hotel/Motel - Guest	5.52	5.34	4.77	3.20	3.93
		Manufacturing Facility	3.29	3.18	2.95	1.78	1.99
		MF - High Rise	4.80	4.73	4.31	3.67	3.68
		MF - High Rise - Common	5.70	5.54	4.96	3.42	4.41
		MF - High Rise - Residential	4.63	4.60	4.17	3.62	3.53
		MF - Mid Rise	5.23	5.29	4.55	3.35	3.82
		Movie Theater	5.71	5.62	5.25	4.00	4.76
		Office - High Rise - CAV no econ	6.34	6.44	5.87	3.93	4.28
		Office - High Rise - CAV econ	6.56	6.69	6.16	4.24	4.67
		Office - High Rise - VAV econ	4.80	4.89	4.03	2.38	2.66
		Office - High Rise - FCU	3.52	3.46	2.99	1.58	1.67
		Office - Low Rise	4.48	4.48	3.55	2.18	2.49
		Office - Mid Rise	4.98	4.98	4.22	2.69	2.98
		Religious Building	5.03	4.72	4.52	3.31	3.78
		Restaurant	4.24	4.26	3.82	2.89	3.43
	Retail - Department Store	4.37	4.01	3.77	2.45	2.80	
	Retail - Strip Mall	4.18	3.87	3.42	2.36	2.55	
	Warehouse	4.57	4.26	4.40	2.75	3.38	
	Unknown	4.88	4.83	4.30	3.09	3.57	
	Hot Water Space Heating without outdoor reset – non-recirculation	Assembly	7.10	7.27	6.49	4.33	6.63
Assisted Living		6.69	6.53	5.74	4.22	5.08	
College		6.08	5.68	5.07	2.81	3.37	
Convenience Store		5.88	5.43	4.82	3.46	3.86	
Elementary School		7.07	6.90	6.08	4.20	5.10	
Garage		3.91	3.85	3.38	2.70	2.99	
Grocery		6.39	6.36	5.58	3.48	4.16	
Healthcare Clinic		6.27	6.44	5.62	3.83	4.05	
High School		7.33	7.38	6.62	4.71	5.51	
Hospital - CAV no econ		7.01	7.22	6.15	5.29	6.00	

Location	System Type	Building Type	Annual therm Savings per linear foot (therm /ft) (2" pipe / 1" insulation for hot water, 2" insulation for steam)				
			Zone 1 (Rockford)	Zone 2 (Chicago)	Zone 3 (Springfield)	Zone 4 (Belleville)	Zone 5 (Marion)
		Hospital - CAV econ	7.10	7.36	6.28	5.44	6.17
		Hospital - VAV econ	2.91	2.76	2.07	1.24	1.35
		Hospital - FCU	5.26	6.01	4.89	5.75	7.73
		Hotel/Motel	6.99	6.80	6.13	4.20	5.12
		Hotel/Motel - Common	6.36	6.46	6.15	5.00	5.25
		Hotel/Motel - Guest	6.99	6.76	6.04	4.05	4.97
		Manufacturing Facility	4.17	4.03	3.73	2.26	2.52
		MF - High Rise	6.06	5.98	5.45	4.64	4.65
		MF - High Rise - Common	7.21	7.00	6.28	4.33	5.58
		MF - High Rise - Residential	5.86	5.82	5.28	4.57	4.46
		MF - Mid Rise	6.62	6.70	5.76	4.24	4.83
		Movie Theater	7.22	7.11	6.65	5.05	6.02
		Office - High Rise - CAV no econ	8.02	8.15	7.42	4.97	5.42
		Office - High Rise - CAV econ	8.30	8.47	7.78	5.37	5.91
		Office - High Rise - VAV econ	6.07	6.19	5.10	3.01	3.36
		Office - High Rise - FCU	4.44	4.37	3.78	2.01	2.10
		Office - Low Rise	5.68	5.66	4.50	2.75	3.15
		Office - Mid Rise	6.30	6.30	5.34	3.40	3.77
		Religious Building	6.37	5.97	5.72	4.19	4.79
		Restaurant	5.37	5.38	4.83	3.66	4.33
		Retail - Department Store	5.53	5.08	4.77	3.10	3.54
		Retail - Strip Mall	5.29	4.90	4.33	2.98	3.22
		Warehouse	5.78	5.39	5.56	3.47	4.28
		Unknown	6.17	6.11	5.44	3.90	4.52
	Hot Water with outdoor reset	All buildings, Recirculation heating season only (Hours below 55F)	15.82	15.58	14.11	12.62	13.03
	Hot Water without outdoor reset	All buildings, Recirculation heating season only (Hours below 55F)	20.02	19.71	17.86	15.97	16.49
	Hot Water with outdoor reset	All buildings, Recirculation year round (All hours)	23.16	23.16	23.16	23.16	23.16
	Hot Water without outdoor reset	All buildings, Recirculation year round (All hours)	34.79	34.79	34.79	34.79	34.79
	LP Steam – non-recirculation	Assembly	11.11	11.38	10.16	6.77	10.37
		Assisted Living	10.46	10.23	8.99	6.61	7.94
		College	9.51	8.89	7.93	4.40	5.28
		Convenience Store	9.21	8.50	7.55	5.42	6.05
		Elementary School	11.07	10.79	9.52	6.57	7.98
		Garage	6.12	6.02	5.29	4.23	4.68
		Grocery	10.00	9.96	8.73	5.45	6.50
		Healthcare Clinic	9.81	10.07	8.79	5.99	6.33
		High School	11.47	11.54	10.35	7.38	8.63
		Hospital - CAV no econ	10.97	11.30	9.63	8.28	9.40
		Hospital - CAV econ	11.11	11.52	9.82	8.51	9.66
		Hospital - VAV econ	4.54	4.32	3.25	1.95	2.11
		Hospital - FCU	8.24	9.41	7.66	9.00	12.10
		Hotel/Motel	10.95	10.64	9.60	6.56	8.02
		Hotel/Motel - Common	9.95	10.11	9.62	7.83	8.23

			Annual therm Savings per linear foot (therm /ft) (2" pipe / 1" insulation for hot water, 2" insulation for steam)				
Location	System Type	Building Type	Zone 1 (Rockford)	Zone 2 (Chicago)	Zone 3 (Springfield)	Zone 4 (Belleville)	Zone 5 (Marion)
		Hotel/Motel - Guest	10.93	10.57	9.46	6.33	7.78
		Manufacturing Facility	6.51	6.30	5.84	3.53	3.94
		MF - High Rise	11.82	11.66	10.63	9.05	9.07
		MF - High Rise - Common	14.05	13.65	12.23	8.43	10.89
		MF - High Rise - Residential	11.42	11.33	10.30	8.92	8.70
		MF - Mid Rise	12.90	13.05	11.23	8.26	9.41
		Movie Theater	11.30	11.14	10.41	7.91	9.42
		Office - High Rise - CAV no econ	12.56	12.74	11.62	7.78	8.47
		Office - High Rise - CAV econ	12.99	13.25	12.19	8.40	9.24
		Office - High Rise - VAV econ	9.49	9.69	7.98	4.71	5.26
		Office - High Rise - FCU	6.96	6.85	5.92	3.15	3.29
		Office - Low Rise	8.88	8.86	7.04	4.31	4.93
		Office - Mid Rise	9.86	9.86	8.35	5.31	5.91
		Religious Building	9.97	9.35	8.95	6.56	7.50
		Restaurant	8.39	8.42	7.56	5.72	6.78
		Retail - Department Store	8.65	7.95	7.46	4.85	5.54
		Retail - Strip Mall	8.28	7.67	6.77	4.67	5.03
		Warehouse	9.05	8.44	8.71	5.44	6.70
		Unknown	9.66	9.57	8.51	6.11	7.08
	LP Steam	All buildings, Recirculation heating season only (Hours below 55F)	31.32	30.85	27.94	25.00	25.80
	LP Steam	All buildings, Recirculation year round (All hours)	54.46	54.46	54.46	54.46	54.46
	HP Steam – non-recirculation	Assembly	17.20	17.62	15.73	10.48	16.06
		Assisted Living	16.20	15.84	13.91	10.23	12.29
		College	14.73	13.76	12.28	6.82	8.17
		Convenience Store	14.25	13.16	11.68	8.38	9.36
		Elementary School	17.14	16.70	14.73	10.18	12.35
		Garage	9.47	9.32	8.20	6.54	7.24
		Grocery	15.47	15.41	13.51	8.43	10.07
		Healthcare Clinic	15.19	15.59	13.61	9.27	9.81
		High School	17.75	17.87	16.03	11.42	13.36
		Hospital - CAV no econ	16.98	17.49	14.90	12.82	14.55
		Hospital - CAV econ	17.21	17.83	15.20	13.17	14.96
		Hospital - VAV econ	7.04	6.68	5.02	3.02	3.27
		Hospital - FCU	12.76	14.56	11.85	13.93	18.73
		Hotel/Motel	16.95	16.48	14.86	10.17	12.41
		Hotel/Motel - Common	15.40	15.65	14.90	12.12	12.74
		Hotel/Motel - Guest	16.92	16.38	14.64	9.80	12.05
		Manufacturing Facility	10.09	9.75	9.04	5.46	6.10
		MF - High Rise	14.69	14.50	13.22	11.25	11.28
		MF - High Rise - Common	17.46	16.96	15.21	10.48	13.53
		MF - High Rise - Residential	14.19	14.08	12.80	11.09	10.81
		MF - Mid Rise	16.04	16.22	13.96	10.26	11.70
		Movie Theater	17.49	17.23	16.12	12.25	14.59
		Office - High Rise - CAV no econ	19.44	19.73	17.98	12.05	13.12
	Office - High Rise - CAV econ	20.10	20.51	18.86	13.00	14.30	

Location	System Type	Building Type	Annual therm Savings per linear foot (therm /ft) (2" pipe / 1" insulation for hot water, 2" insulation for steam)				
			Zone 1 (Rockford)	Zone 2 (Chicago)	Zone 3 (Springfield)	Zone 4 (Belleville)	Zone 5 (Marion)
		Office - High Rise - VAV econ	14.70	14.99	12.36	7.30	8.14
		Office - High Rise - FCU	10.76	10.60	9.16	4.86	5.10
		Office - Low Rise	13.75	13.71	10.89	6.66	7.63
		Office - Mid Rise	15.25	15.27	12.92	8.23	9.15
		Religious Building	15.43	14.47	13.85	10.15	11.60
		Restaurant	12.99	13.03	11.70	8.85	10.49
		Retail - Department Store	13.39	12.31	11.55	7.52	8.57
		Retail - Strip Mall	12.82	11.87	10.49	7.23	7.79
		Warehouse	14.01	13.06	13.48	8.41	10.37
		Unknown	14.95	14.81	13.17	9.45	10.96
		HP Steam	All buildings, Recirculation heating season only (Hours below 55F)	48.49	47.76	43.25	38.69
HP Steam	All buildings, Recirculation year round (All hours)	84.30	84.30	84.30	84.30	84.30	

For insulation covering elbows and tees that connect straight pipe, a calculated surface area will be assumed based on the dimensions for fittings given by ANSI/ASME B36.19. The surface area is then converted to an equivalent length of pipe, that must be added to the total length of straight pipe to calculate total savings. Equivalent pipe lengths are given in 1" increments in pipe diameter for simplicity. In the case of pipe diameters in between full inch diameters, interpolation should be used to determine the equivalent length. The larger pipe sizes mostly apply to steam header piping, which has the most heat loss per foot.

Calculated Surface Areas of Elbows and Tees

Nominal Pipe Diameter	Calculated Surface Area (ft)	
	90 Degree Elbow ⁷²⁹	Straight Tee ⁷³⁰
1"	0.10	0.13
2"	0.41	0.39
3"	0.93	0.77
4"	1.64	1.21
5"	2.57	1.77
6"	3.70	2.44
8"	6.58	3.95
10"	10.28	5.98
12"	14.80	8.34

Equivalent Length of Other Components – Elbows and Tees (L_{oc})

Nominal Pipe Diameter	Equivalent Length of Other Components (ft)	
	90 Degree Elbow	Straight Tee
1"	0.30	0.38
2"	0.66	0.63
3"	1.01	0.84
4"	1.40	1.03

⁷²⁹ Based on the dimensions for diameter, long radius, and short radius given by ANSI/ASME 36.19.

⁷³⁰ Based on the center to face and diameter dimensions given by ANSI/ASME B36.19.

Nominal Pipe Diameter	Equivalent Length of Other Components (ft)	
	90 Degree Elbow	Straight Tee
5"	1.76	1.22
6"	2.13	1.41
8"	2.91	1.75
10"	3.65	2.13
12"	4.44	2.50

For insulation around valves or flanges, a surface area from ASTM standard C1129-12 will be assumed for 2" pipes. For 1" pipes, which weren't included in the standard, a linear-trended value will be used. The surface area is then converted to an equivalent length of either 1" or 2" straight pipe that must be added to the total length of straight pipe to calculate total savings.

Calculated Surface Areas of Flanges and Valves

Valves				
ANSI Class	150	300	600	900
NPS (in)	ft ²	ft ²	ft ²	ft ²
1	0.69	1.8	1.8	2.4
2	2.21	2.94	2.94	5.2
2.5	2.97	3.51	3.91	6.6
3	3.37	4.39	4.69	6.5
4	4.68	6.06	7.64	9.37
6	7.03	9.71	13.03	15.8
8	10.3	13.5	18.4	23.8
10	13.8	18	26.5	32.1
12	16.1	24.1	31.9	41.9

Flanges				
ANSI Class	150	300	600	900
NPS (in)	ft ²	ft ²	ft ²	ft ²
1	0.36	0.36	0.4	1.23
2	0.71	0.84	0.88	1.54
3	1.06	1.32	1.36	1.85
4	1.44	1.83	2.23	2.64
6	2.04	2.72	3.6	4.37
8	2.92	3.74	4.89	6.4
10	3.68	4.8	6.93	8.47
12	5.01	6.34	7.97	10.43

Equivalent Length of Other Components - Flanges and Valves (L_{oc})

ANSI Class	Equivalent Length of Other Components (ft)			
	1" Valve	1" Flange	2" Valve	2" Flange
150	2.00	1.04	3.56	1.14
300	5.22	1.04	4.73	1.35
600	5.22	1.16	4.73	1.42
900	6.96	3.57	8.37	2.48
ANSI Class	3" Valve	3" Flange	4" Valve	4" Flange
150	3.67	1.16	3.98	1.22
300	4.79	1.44	5.15	1.56
600	5.11	1.48	6.49	1.90
900	7.09	2.02	7.96	2.24

WATER IMPACT DESCRIPTIONS AND CALCULATION

N/A

DEEMED O&M COST ADJUSTMENT CALCULATION

N/A

MEASURE CODE: CI-HVC-PINS-V09-250101

REVIEW DEADLINE: 1/1/2027

4.4.15 Single-Package and Split System Unitary Air Conditioners

DESCRIPTION

This measure promotes the installation of high-efficiency unitary air-, water-, and evaporatively-cooled air conditioning equipment, both single-package and split systems. Air conditioning (AC) systems are a major consumer of electricity and systems that exceed baseline efficiency requirements can significantly reduce energy consumption. This measure could apply to the replacing of an existing unit at the end of its useful life or the installation of a new unit in a new or existing building.

This measure was developed to be applicable to the following program types: TOS, NC, EREP. If applied to other program types, the measure savings should be verified.

DEFINITION OF EFFICIENT EQUIPMENT

The efficient equipment is assumed to be a high-efficiency air-, water-, or evaporatively-cooled air conditioner that exceeds the energy efficiency requirements as prescribed by the program.

DEFINITION OF BASELINE EQUIPMENT

In order for this characterization to apply, the baseline equipment is assumed to be a standard-efficiency air-, water-, or evaporatively-cooled air conditioner that meets the Code energy efficiency requirements (IECC or Code of Federal Regulations whichever is higher) in effect on the date of equipment purchase (if date is unknown, assume current Code minimum).

For Early Replacement programs, use the actual efficiency of the existing unit or assume IECC code base in place at the original time of existing unit installation. To qualify under the early replacement characterization, baseline equipment must meet these additional qualifications:

- The existing unit is operational when replaced or the existing unit would be operational with minor repairs.⁷³¹

In order for this characterization to apply, the baseline equipment is assumed to meet the efficiency requirements within the IECC code in effect on the date of the building permit. As code requirements and adoption can differ from municipality to municipality, the user should verify which version of code is applicable given these constraints.

Note, IECC 2021 became effective statewide on 1/1/2024. IECC 2018 is the requisite code for any projects with permitting dates spanning July 1, 2019 to 12/31/2023. Prior to July 1, 2019, IECC 2015 is the applicable code. If evaluation determines the applicable version of code, given location and timing, isn't an appropriate baseline due to supply constraints, low compliance, or other issues, the previous iteration of code may be used through 2023.

IECC 2021 leverages new DOE testing methods and associated metrics. The following conversion factors are recommended for use if the efficient equipment is not rated under the new testing procedure but the stipulated baseline is:⁷³²

$$\text{SEER2} = X * \text{SEER}$$

$$\text{EER2} = X * \text{EER}$$

$$\text{HSPF2} = X * \text{HSPF}$$

Where:

⁷³¹ Based on ComEd Small Business Trade Ally feedback. For units rated at less than 20 ton units, the cost of common repairs is under \$2,000, significantly less than the cost of purchasing new equipment. Therefore, if the cost of repair is less than \$2,000, it can be considered early replacement because customers would repair instead of replace a failed unit. Repair cost data was not available for units larger than 20 tons.

⁷³² Consortium for Energy Efficiency (CEE), Testing, Testing, M1, 2, 3, Transitioning to New Federal Minimum Standards, CEE Summer Program Meeting, August, 2022.

X	SEER2	EER2	HSPF2
Ducted	0.95	0.95	0.85
Ductless	1.00	1.00	0.90
Packaged	0.95	0.95	0.84

Note: new Federal Standards affecting heat pumps and air conditioning equipment became effective January 1, 2023.

DEEMED LIFETIME OF EFFICIENT EQUIPMENT

The expected measure life is assumed to be 15 years.⁷³³

For early replacement, the remaining life of existing equipment is assumed to be 5 years.⁷³⁴

DEEMED MEASURE COST

The incremental capital cost for this measure is based upon capacity and efficiency level (defined by CEE specifications),⁷³⁵ as outlined in the following table:⁷³⁶

Capacity	Incremental cost (\$/ton)	
	Up to and including CEE Tier 1 units	CEE Tier 2 and above
< 135,000 Btu/hr	\$63	\$127
135,000 Btu/hr to > 250,000 Btu/hr	\$63	\$127
250,000 Btu/hr and greater	\$19	\$38

For early replacement, the full cost of the installed unit should be used. If unknown use defaults below. The assumed deferred cost (after 5 years) of replacing existing equipment with a new baseline unit is also provided. This future cost should be discounted to present value using the real discount rate:

Capacity	Full Install Cost (\$/ton)		
	Base Units	Up to and including CEE Tier 1 units	CEE Tier 2 and above
< 135,000 Btu/hr	\$895	\$958	\$1,021
135,000 Btu/hr to > 250,000 Btu/hr	\$762	\$825	\$889
250,000 Btu/hr and greater	\$673	\$691	\$710

LOADSHAPE

Loadshape C03 - Commercial Cooling

COINCIDENCE FACTOR

The summer peak coincidence factor for cooling is provided in two different ways below. The first is used to estimate peak savings during the utility peak hour and is most indicative of actual peak benefits, and the second represents the *average* savings over the defined summer peak period and is presented so that savings can be bid into PJM’s capacity market. Both values provided are based on analysis of Itron eShape data for Missouri, calibrated to Illinois loads, supplied by Ameren.

⁷³³ Measure Life Report: Residential and Commercial/Industrial Lighting and HVAC Measures, GDS Associates, Inc., June 2007.

⁷³⁴ Assumed to be one third of effective useful life.

⁷³⁵ CEE Commercial Unitary Air-conditioning and Heat Pumps Specification, which provides high efficiency performance specifications for single-package and split system unitary air conditioners.

⁷³⁶ NEEP Incremental Cost Study (ICS) Final Report – Phase 3, May 2014.

- CF_{SSP} = Summer System Peak Coincidence Factor for Commercial cooling (during system peak hour)
 = 91.3% ⁷³⁷
- CF_{PJM} = PJM Summer Peak Coincidence Factor for Commercial cooling (average during peak period)
 = 47.8% ⁷³⁸

Algorithm

CALCULATION OF SAVINGS

ELECTRIC ENERGY SAVINGS

Time of Sale:

For units with cooling capacities less than 65 kBtu/hr:

$$\Delta\text{kWH} = (\text{kBtu/hr}) * [(1/\text{SEER}_{\text{base}}) - (1/\text{SEER}_{\text{ee}})] * \text{EFLH}$$

For units with cooling capacities equal to or greater than 65 kBtu/hr:

$$\Delta\text{kWH} = (\text{kBtu/hr}) * [(1/\text{IEER}_{\text{base}}) - (1/\text{IEER}_{\text{ee}})] * \text{EFLH}$$

Early replacement:⁷³⁹

For units with cooling capacities less than 65 kBtu/hr:

For remaining life of existing unit (1st 5 years):

$$\Delta\text{kWH} = (\text{kBtu/hr}) * [(1/\text{SEER}_{\text{exist}}) - (1/\text{SEER}_{\text{ee}})] * \text{EFLH}$$

For remaining measure life (next 10 years):

$$\Delta\text{kWH} = (\text{kBtu/hr}) * [(1/\text{SEER}_{\text{base}}) - (1/\text{SEER}_{\text{ee}})] * \text{EFLH}$$

For units with cooling capacities equal to or greater than 65 kBtu/hr:

For remaining life of existing unit (1st 5 years):

$$\Delta\text{kWH} = (\text{kBtu/hr}) * [(1/\text{IEER}_{\text{exist}}) - (1/\text{IEER}_{\text{ee}})] * \text{EFLH}$$

NOTE: If the existing equipment age is such that IEER ratings are not available, EER may be substituted when necessary. In such instances both existing and efficient unit efficiencies should be specified in EER.

For remaining measure life (next 10 years):

$$\Delta\text{kWH} = (\text{kBtu/hr}) * [(1/\text{IEER}_{\text{base}}) - (1/\text{IEER}_{\text{ee}})] * \text{EFLH}$$

Where:

- kBtu/hr = capacity of the cooling equipment actually installed in kBtu per hour (1 ton of cooling capacity equals 12 kBtu/hr)
- SEER_{base} = Seasonal Energy Efficiency Ratio of the baseline equipment

⁷³⁷ Based on analysis of Itron eShape data for Missouri, calibrated to Illinois loads, supplied by Ameren. The AC load during the utility's peak hour is divided by the maximum AC load during the year.

⁷³⁸ Based on analysis of Itron eShape data for Missouri, calibrated to Illinois loads, supplied by Ameren. The average AC load over the PJM peak period (1-5pm, M-F, June through August) is divided by the maximum AC load during the year.

⁷³⁹ The two equations are provided to show how savings are determined during the initial phase of the measure (existing to efficient) and the remaining phase (new baseline to efficient). In practice, the screening tools used may either require a First Year savings (using the first equation) and then a "number of years to adjustment" and "savings adjustment" input which would be the (new base to efficient savings)/(existing to efficient savings).

= SEER values from tables below, based on applicable Code on date of equipment purchase (if unknown assume current Code).

SEER_{ee} = Seasonal Energy Efficiency Ratio of the energy efficient equipment (actually installed)

SEER_{exist} = Seasonal Energy Efficiency Ratio of the existing equipment

= Actual, or assume Code base in place at the original time of existing unit installation

IEER_{base} = Integrated Energy Efficiency Ratio of the baseline equipment. See table below based on applicable Code on date of equipment purchase (if unknown assume current Code).

IEER_{ee} = Integrated Energy Efficiency Ratio of the energy efficient equipment (actually installed)

IEER_{exist} = Integrated Energy Efficiency Ratio of the existing equipment

= Actual, or assume Code base in place at the original time of existing unit installation

EFLH = Equivalent Full Load Hours for cooling in Existing Buildings or New Construction are provided in section 4.4 HVAC End Use

The rating conditions for the baseline and efficient equipment efficiencies must be equivalent.

Code of Federal Redulations (baseline effective 1/1/2023):⁷⁴⁰

Equipment type	Cooling capacity	Heating type	Efficiency level	Compliance date
Small Commercial Packaged Air Conditioning and Heating Equipment (Air-Cooled)	≥65,000 Btu/h and <135,000 Btu/h	Electric Resistance Heating or No Heating	IEER = 12.9 IEER = 14.8	1/1/2018 1/1/2023
		All Other Types of Heating	IEER = 12.7 IEER = 14.6	1/1/2018 1/1/2023
Large Commercial Packaged Air Conditioning and Heating Equipment (Air-Cooled)	≥135,000 Btu/h and <240,000 Btu/h	Electric Resistance Heating or No Heating	IEER = 12.4 IEER = 14.2	1/1/2018 1/1/2023
		All Other Types of Heating	IEER = 12.2 IEER = 14.0	1/1/2018 1/1/2023
Very Large Commercial Packaged Air Conditioning and Heating Equipment (Air-Cooled)	≥240,000 Btu/h and <760,000 Btu/h	Electric Resistance Heating or No Heating	IEER = 11.6 IEER = 13.2	1/1/2018 1/1/2023
		All Other Types of Heating	IEER = 11.4 IEER = 13.0	1/1/2018 1/1/2023
Small Commercial Package Air-Conditioning and Heating Equipment (Air-Cooled, 3-Phase, Split-System)	<65,000 Btu/h	All	SEER2 = 14.3	1/1/2023
Small Commercial Package Air-Conditioning and Heating Equipment (Air-Cooled, 3-Phase, Single-Package)	<65,000Btu/h	All	SEER2 = 13.4	1/1/2023

⁷⁴⁰ Code of Federal Regulations: Table 3 to §431.97 – Updates to Minimum Cooling Efficiency Standards for Air Conditioning and Heating Equipment

2015 IECC Minimum Efficiency Requirements (baseline effective 1/1/2016 to 6/30/2019)

TABLE C403.2.3(1)
MINIMUM EFFICIENCY REQUIREMENTS:
ELECTRICALLY OPERATED UNITARY AIR CONDITIONERS AND CONDENSING UNITS

EQUIPMENT TYPE	SIZE CATEGORY	HEATING SECTION TYPE	SUBCATEGORY OR RATING CONDITION	MINIMUM EFFICIENCY		TEST PROCEDURE ^a		
				Before 1/1/2016	As of 1/1/2016			
Air conditioners, air cooled	< 65,000 Btu/h ^b	All	Split System	13.0 SEER	13.0 SEER	AHRI 210/240		
			Single Package	13.0 SEER	14.0 SEER ^c			
Through-the-wall (air cooled)	≤ 30,000 Btu/h ^b	All	Split system	12.0 SEER	12.0 SEER			
			Single Package	12.0 SEER	12.0 SEER			
Small-duct high-velocity (air cooled)	< 65,000 Btu/h ^b	All	Split System	11.0 SEER	11.0 SEER			
Air conditioners, air cooled	≥ 65,000 Btu/h and < 135,000 Btu/h	Electric Resistance (or None)	Split System and Single Package	11.2 EER 11.4 IEER	11.2 EER 12.8 IEER		AHRI 340/360	
			All other	Split System and Single Package	11.0 EER 11.2 IEER	11.0 EER 12.6 IEER		
	≥ 135,000 Btu/h and < 240,000 Btu/h	Electric Resistance (or None)		Split System and Single Package	11.0 EER 11.2 IEER	11.0 EER 12.4 IEER		
			All other	Split System and Single Package	10.8 EER 11.0 IEER	10.8 EER 12.2 IEER		
	≥ 240,000 Btu/h and < 760,000 Btu/h	Electric Resistance (or None)		Split System and Single Package	10.0 EER 10.1 IEER	10.0 EER 11.6 IEER		
			All other	Split System and Single Package	9.8 EER 9.9 IEER	9.8 EER 11.4 IEER		
	≥ 760,000 Btu/h	Electric Resistance (or None)		Split System and Single Package	9.7 EER 9.8 IEER	9.7 EER 11.2 IEER		
			All other	Split System and Single Package	9.5 EER 9.6 IEER	9.5 EER 11.0 IEER		
	Air conditioners, water cooled	< 65,000 Btu/h ^b		All	Split System and Single Package	12.1 EER 12.3 IEER		12.1 EER 12.3 IEER
			≥ 65,000 Btu/h and < 135,000 Btu/h		Electric Resistance (or None)	Split System and Single Package		12.1 EER 12.3 IEER
		All other		Split System and Single Package		11.9 EER 12.1 IEER		11.9 EER 13.7 IEER
			≥ 135,000 Btu/h and < 240,000 Btu/h	Electric Resistance (or None)	Split System and Single Package	12.5 EER 12.5 IEER		12.5 EER 13.9 IEER
All other		Split System and Single Package			12.3 EER 12.5 IEER	12.3 EER 13.7 IEER		
		≥ 240,000 Btu/h and < 760,000 Btu/h	Electric Resistance (or None)	Split System and Single Package	12.4 EER 12.6 IEER	12.4 EER 13.6 IEER		
All other				Split System and Single Package	12.2 EER 12.4 IEER	12.2 EER 13.4 IEER		
		≥ 760,000 Btu/h	Electric Resistance (or None)	Split System and Single Package	12.2 EER 12.4 IEER	12.2 EER 13.5 IEER		
All other				Split System and Single Package	12.0 EER 12.2 IEER	12.0 EER 13.3 IEER		

(continued)

2018 IECC Minimum Efficiency Requirements (baseline effective 7/1/2019 to 9/30/2022)

TABLE C403.3.2(1)
 MINIMUM EFFICIENCY REQUIREMENTS: ELECTRICALLY OPERATED UNITARY AIR CONDITIONERS AND CONDENSING UNITS

EQUIPMENT TYPE	SIZE CATEGORY	HEATING SECTION TYPE	SUBCATEGORY OR RATING CONDITION	MINIMUM EFFICIENCY	TEST PROCEDURE ^a		
Air conditioners, air cooled	< 65,000 Btu/h ^b	All	Split System	13.0 SEER	AHRI 210/240		
			Single Package	14.0 SEER			
Through-the-wall (air cooled)	≤ 30,000 Btu/h ^b	All	Split system	12.0 SEER			
			Single Package	12.0 SEER			
Small-duct high-velocity (air cooled)	< 65,000 Btu/h ^b	All	Split System	11.0 SEER			
Air conditioners, air cooled	≥ 65,000 Btu/h and < 135,000 Btu/h	Electric Resistance (or None)	Split System and Single Package	11.2 EER 12.8 IEER	AHRI 340/360		
		All other	Split System and Single Package	11.0 EER 12.6 IEER			
	≥ 135,000 Btu/h and < 240,000 Btu/h	Electric Resistance (or None)	Split System and Single Package	11.0 EER 12.4 IEER			
		All other	Split System and Single Package	10.8 EER 12.2 IEER			
	≥ 240,000 Btu/h and < 760,000 Btu/h	Electric Resistance (or None)	Split System and Single Package	10.0 EER 11.6 IEER			
		All other	Split System and Single Package	9.8 EER 11.4 IEER			
	≥ 760,000 Btu/h	Electric Resistance (or None)	Split System and Single Package	9.7 EER 11.2 IEER			
		All other	Split System and Single Package	9.5 EER 11.0 IEER			
	Air conditioners, water cooled	< 65,000 Btu/h ^b	All	Split System and Single Package		12.1 EER 12.3 IEER	AHRI 210/240
≥ 65,000 Btu/h and < 135,000 Btu/h		Electric Resistance (or None)	Split System and Single Package	12.1 EER 13.9 IEER	AHRI 340/360		
		All other	Split System and Single Package	11.9 EER 13.7 IEER			
≥ 135,000 Btu/h and < 240,000 Btu/h		Electric Resistance (or None)	Split System and Single Package	12.5 EER 13.9 IEER			
		All other	Split System and Single Package	12.3 EER 13.7 IEER			
≥ 240,000 Btu/h and < 760,000 Btu/h		Electric Resistance (or None)	Split System and Single Package	12.4 EER 13.6 IEER			
		All other	Split System and Single Package	12.2 EER 13.4 IEER			
≥ 760,000 Btu/h		Electric Resistance (or None)	Split System and Single Package	12.2 EER 13.5 IEER			
		All other	Split System and Single Package	12.0 EER 13.3 IEER			

Air conditioners, evaporatively cooled	< 65,000 Btu/h ^b	All	Split System and Single Package	12.1 EER 12.3 IEER	AHRI 210/240
	≥ 65,000 Btu/h and < 135,000 Btu/h	Electric Resistance (or None)	Split System and Single Package	12.1 EER 12.3 IEER	AHRI 340/360
		All other	Split System and Single Package	11.9 EER 12.1 IEER	
	≥ 135,000 Btu/h and < 240,000 Btu/h	Electric Resistance (or None)	Split System and Single Package	12.0 EER 12.2 IEER	
		All other	Split System and Single Package	11.8 EER 12.0 IEER	
	≥ 240,000 Btu/h and < 760,000 Btu/h	Electric Resistance (or None)	Split System and Single Package	11.9 EER 12.1 IEER	
		All other	Split System and Single Package	11.7 EER 11.9 IEER	
	≥ 760,000 Btu/h	Electric Resistance (or None)	Split System and Single Package	11.7 EER 11.9 IEER	
All other		Split System and Single Package	11.5 EER 11.7 IEER		
Condensing units, air cooled	≥ 135,000 Btu/h	—	—	10.5 EER 11.8 IEER	AHRI 365
Condensing units, water cooled	≥ 135,000 Btu/h	—	—	13.5 EER 14.0 IEER	
Condensing units, evaporatively cooled	≥ 135,000 Btu/h	—	—	13.5 EER 14.0 IEER	

For SI: 1 British thermal unit per hour = 0.2931 W.

- a. Chapter 6 contains a complete specification of the referenced test procedure, including the reference year version of the test procedure.
- b. Single-phase, air-cooled air conditioners less than 65,000 Btu/h are regulated by NAECA. SEER values are those set by NAECA.

2021 IECC Minimum Efficiency Requirements (baseline effective 10/1/2022)

**TABLE C403.3.2(1)
ELECTRICALLY OPERATED UNITARY AIR CONDITIONERS AND CONDENSING UNITS—MINIMUM EFFICIENCY REQUIREMENTS^{c, d}**

EQUIPMENT TYPE	SIZE CATEGORY	HEADING SECTION TYPE	SUBCATEGORY OR RATING CONDITION	MINIMUM EFFICIENCY	TEST PROCEDURE ^a
Air conditioners, air cooled	< 65,000 Btu/h ^b	All	Split system, three phase and applications outside US single phase ^b	13.0 SEER before 1/1/2023 13.4 SEER2 after 1/1/2023	AHRI 210/240—2017 before 1/1/2023 AHRI 210/240—2023 after 1/1/2023
			Single-package, three phase and applications outside US single phase ^b	14.0 SEER before 1/1/2023 13.4 SEER2 after 1/1/2023	
Space constrained, air cooled	≤ 30,000 Btu/h ^b	All	Split system, three phase and applications outside US single phase ^b	12.0 SEER before 1/1/2023 11.7 SEER2 after 1/1/2023	AHRI 210/240—2017 before 1/1/2023 AHRI 210/240—2023 after 1/1/2023
			Single package, three phase and applications outside US single phase ^b	12.0 SEER before 1/1/2023 11.7 SEER2 after 1/1/2023	
Small duct, high velocity, air cooled	< 65,000 Btu/h ^b	All	Split system, three phase and applications outside US single phase ^b	12.0 SEER before 1/1/2023 12.1 SEER2 after 1/1/2023	AHRI 210/240—2017 before 1/1/2023 AHRI 210/240—2023 after 1/1/2023
Air conditioners, air cooled	≥ 65,000 Btu/h and < 135,000 Btu/h	Electric resistance (or none)	Split system and single package	11.2 EER 12.9 IEER before 1/1/2023 14.8 IEER after 1/1/2023	AHRI 340/360
		All other		11.0 EER 12.7 IEER before 1/1/2023 14.6 IEER after 1/1/2023	
	Electric resistance (or none)	11.0 EER 12.4 IEER before 1/1/2023 14.2 IEER after 1/1/2023			
	All other	10.8 EER 12.2 IEER before 1/1/2023 14.0 IEER after 1/1/2023			
≥ 135,000 Btu/h and < 240,000 Btu/h					

**TABLE C403.3.2(1)—continued
ELECTRICALLY OPERATED UNITARY AIR CONDITIONERS AND CONDENSING UNITS—MINIMUM EFFICIENCY REQUIREMENTS^{c, d}**

EQUIPMENT TYPE	SIZE CATEGORY	HEADING SECTION TYPE	SUBCATEGORY OR RATING CONDITION	MINIMUM EFFICIENCY	TEST PROCEDURE ^e			
Air conditioners, air cooled <i>(continued)</i>	≥ 240,000 Btu/h and < 760,000 Btu/h	Electric resistance (or none)	Split system and single package	10.0 EER 11.6 IEER before 1/1/2023 13.2 IEER after 1/1/2023	AHRI 340/360			
		All other		9.8 EER 11.4 IEER before 1/1/2023 13.0 IEER after 1/1/2023				
	≥ 760,000 Btu/h	Electric resistance (or none)		9.7 EER 11.2 IEER before 1/1/2023 12.5 IEER after 1/1/2023				
		All other		9.5 EER 11.0 IEER before 1/1/2023 12.3 IEER after 1/1/2023				
		Air conditioners, water cooled		< 65,000 Btu/h		All	12.1 EER 12.3 IEER	AHRI 210/240
						≥ 65,000 Btu/h and < 135,000 Btu/h	Electric resistance (or none)	12.1 EER 13.9 IEER
All other	11.9 EER 13.7 IEER							
≥ 135,000 Btu/h and < 240,000 Btu/h	Electric resistance (or none)		12.5 EER 13.9 IEER					
	All other		12.3 EER 13.7 IEER					
≥ 240,000 Btu/h and < 760,000 Btu/h	Electric resistance (or none)		12.4 EER 13.6 IEER					
	All other	12.2 EER 13.4 IEER						
≥ 760,000 Btu/h	Electric resistance (or none)	12.2 EER 13.5 IEER						
	All other	12.0 EER 13.3 IEER						

TABLE C403.3.2(1)—continued
ELECTRICALLY OPERATED UNITARY AIR CONDITIONERS AND CONDENSING UNITS—MINIMUM EFFICIENCY REQUIREMENTS^{c, d}

EQUIPMENT TYPE	SIZE CATEGORY	HEADING SECTION TYPE	SUBCATEGORY OR RATING CONDITION	MINIMUM EFFICIENCY	TEST PROCEDURE ^a
Air conditioners, evaporatively cooled	< 65,000 Btu/h ^b	All	Split system and single package	12.1 EER 12.3 IEER	AHRI 210/240
	≥ 65,000 Btu/h and < 135,000 Btu/h	Electric resistance (or none)		12.1 EER 12.3 IEER	AHRI 340/360
		All other		11.9 EER 12.1 IEER	
	≥ 135,000 Btu/h and < 240,000 Btu/h	Electric resistance (or none)		12.0 EER 12.2 IEER	
		All other		11.8 EER 12.0 IEER	
	≥ 240,000 Btu/h and < 760,000 Btu/h	Electric resistance (or none)		11.9 EER 12.1 IEER	
		All other		11.7 EER 11.9 IEER	
	≥ 760,000 Btu/h	Electric resistance (or none)		11.7 EER 11.9 IEER	
All other		11.5 EER 11.7 IEER			
Condensing units, air cooled	≥ 135,000 Btu/h	—	—	10.5 EER 11.8 IEER	AHRI 365
Condensing units, water cooled	≥ 135,000 Btu/h	—	—	13.5 EER 14.0 IEER	AHRI 365
Condensing units, evaporatively cooled	≥ 135,000 Btu/h	—	—	13.5 EER 14.0 IEER	AHRI 365

For SI: 1 British thermal unit per hour = 0.2931 W.

- a. Chapter 6 contains a complete specification of the referenced standards, which include test procedures, including the reference year version of the test procedure.
- b. Single-phase, US air-cooled air conditioners less than 65,000 Btu/h are regulated as consumer products by the US Department of Energy Code of Federal Regulations DOE 10 CFR 430. SEER and SEER2 values for single-phase products are set by the US Department of Energy.
- c. DOE 10 CFR 430 Subpart B Appendix M1 includes the test procedure updates effective 1/1/2023 that will be incorporated in AHRI 210/240—2023.
- d. This table is a replica of ASHRAE 90.1 Table 6.8.1-1 Electrically Operated Unitary Air Conditioners and Condensing Units—Minimum Efficiency Requirements.

For example, a 5 ton air cooled split system with a SEER of 15 at an existing retail strip mall in Rockford would save:

$$\begin{aligned} \Delta \text{kWh} &= (60) * [(1/13) - (1/15)] * 697 \\ &= 429 \text{ kWh} \end{aligned}$$

SUMMER COINCIDENT PEAK DEMAND SAVINGS

Time of Sale:

$$\Delta \text{kW} = (\text{kBtu/hr} * (1/\text{EER}_{\text{base}} - 1/\text{EER}_{\text{ee}})) * \text{CF}$$

Early Replacement:

For remaining life of existing unit (1st 5 years):

$$\Delta \text{kW} = (\text{kBtu/hr}) * [(1/\text{EER}_{\text{exist}}) - (1/\text{EER}_{\text{ee}})] * \text{CF}$$

For remaining measure life (next 10 years):

$$\Delta \text{kW} = (\text{kBtu/hr}) * [(1/\text{EER}_{\text{base}}) - (1/\text{EER}_{\text{ee}})] * \text{CF}$$

Where:

- EER_{base} = Energy Efficiency Ratio of the baseline equipment
= EER values from tables above, based on applicable Code on date of equipment purchase (if unknown assume current Code). (For air-cooled units < 65 kBtu/hr, assume the following conversion from SEER to EER for calculation of peak savings:⁷⁴¹ $\text{EER} = (-0.02 * \text{SEER}^2) + (1.12 * \text{SEER})$)
- EER_{ee} = Energy Efficiency Ratio of the energy efficient equipment. If the actual EER_{ee} is unknown, assume the conversion from SEER to EER for calculation of peak savings as above).
= Actual installed
- $\text{EER}_{\text{exist}}$ = Energy Efficiency Ratio of the existing equipment
= Actual, or assume Code base in place at the original time of existing unit installation
- CF_{SSP} = Summer System Peak Coincidence Factor for Commercial cooling (during system peak hour)
= 91.3%⁷⁴²
- CF_{PJM} = PJM Summer Peak Coincidence Factor for Commercial cooling (average during peak period)
= 47.8%⁷⁴³

⁷⁴¹ Based on Wassmer, M. (2003). A Component-Based Model for Residential Air Conditioner and Heat Pump Energy Calculations. Masters Thesis, University of Colorado at Boulder. Note this is appropriate for single speed units only.

⁷⁴² Based on analysis of Itron eShape data for Missouri, calibrated to Illinois loads, supplied by Ameren. The AC load during the utility’s peak hour is divided by the maximum AC load during the year.

⁷⁴³Based on analysis of Itron eShape data for Missouri, calibrated to Illinois loads, supplied by Ameren. The average AC load over the PJM peak period (1-5pm, M-F, June through August) is divided by the maximum AC load during the year.

For example, a 5 ton air cooled split system with a SEER of 15 in Rockford would save:

$$\begin{aligned}\Delta kW_{SSP} &= (60) * [(1/11.2) - (1/12.3)] * 0.913 \\ &= 0.437 \text{ kW}\end{aligned}$$

FOSSIL FUEL SAVINGS

N/A

WATER IMPACT DESCRIPTIONS AND CALCULATION

N/A

MEASURE CODE: CI-HVC-SPUA-V11-250101

REVIEW DEADLINE: 1/1/2026

4.4.16 Steam Trap Replacement or Repair

DESCRIPTION

The measure applies to the repair or replacement of steam traps in the failed open state that allow steam to escape the steam distribution system or return to the condensate receiver leading to increased steam generation. The measure is applicable to commercial applications, commercial HVAC (low pressure steam) including multifamily buildings, low pressure industrial applications, medium pressure industrial applications, and high-pressure industrial applications.

This measure was developed to be applicable to the following program types: TOS, RF. If applied to other program types, the measure savings should be verified.

DEFINITION OF EFFICIENT EQUIPMENT

The efficient condition is a repaired or replaced steam trap that is no longer allowing excess steam to escape.

Customers must have steam traps in the failed open or leaking state to qualify for rebates. However, if a commercial customer opts to replace all traps without inspection, rebates and the savings are discounted to take into consideration the fact that some traps are being replaced that have not yet failed.

DEFINITION OF BASELINE EQUIPMENT

The baseline criterion is a faulty steam trap in the failed open or leaking state. No minimum leak rate is required. Any leaking or blow through trap can be repaired or replaced. If a commercial customer chooses to repair or replace all the steam traps at the facility without verification, the savings are adjusted. Savings for commercial full replacement projects are reduced by the percentage of traps found to be leaking on average from the studies listed. If an audit is performed on a commercial site, then the leaking and blowdown can be adjusted.

DEEMED LIFETIME OF EFFICIENT EQUIPMENT

For standard steam traps the life of this measure is 6 years.⁷⁴⁴

For Venturi steam traps the measure life is 20 years if replacing a faulty mechanical steam trap.⁷⁴⁵ If replacing an operational mechanical steam trap, the measure life is 14 years, having been reduced by the six-year measure life established for standard steam traps. By applying this conservative approach of reducing the measure life by the full estimated useful life of the existing steam trap, there is no need to survey or produce an inventory of the age of existing steam traps.

Venturi steam traps do not contain any moving parts, and their manufacturers cite this feature for the reduced failure rate leading to longer operational life than mechanical steam traps. Venturi steam traps have been observed to operate in excess of 20 years.⁷⁴⁶ Venturi steam traps also typically come with a 10-year warranty that can be extended up to 20 years. Therefore, savings may be claimed on a year-to-year basis for venturi steam traps undergoing annual maintenance that have exhausted their deemed 20-year measure life.

⁷⁴⁴Source paper is the CLEAResult "Steam Traps Revision #1" dated August 2011. Primary studies used to prepare the source paper include Enbridge Steam Trap Survey, KW Engineering Steam Trap Survey, Enbridge Steam Saver Program 2005, Armstrong Steam Trap Survey, DOE Federal Energy Management Program Steam Trap Performance Assessment, Oak Ridge National Laboratory Steam System Survey Guide, KEMA Evaluation of PG&E's Steam Trap Program, Sept. 2007. Communication with vendors suggested an inverted bucket steam trap life typically in the range of 5 - 7 years, float and thermostatic traps 4- 6 years, float and thermodynamic disc traps of 1 - 3 years.

⁷⁴⁵ "Venturi Steam Trap – Functional Laboratory Study, GTI on behalf of Illinois utilities, Nicor Gas, Peoples Gas, and North Shore Gas, and on behalf of contributing utilities from other states, March 26, 2019. This report reflects phase 1 of an ongoing field study that will continue data collection to validate useful life and provide information on proper sizing in various end use applications. Additional data expected in 2021.

⁷⁴⁶ Ibid. Based on reported age for venturi steam traps currently operating in the field.

DEEMED MEASURE COST

Actual measure costs, including survey and installation costs should be used where available. Default costs per trap are provided below to be used in addition to an estimate of survey and installation costs.

Steam System	Cost per trap ⁷⁴⁷ (\$)
Commercial Dry Cleaners	\$77
Commercial Heating (including Multifamily), low pressure steam	\$77
Industrial Medium Pressure: 15 < psig < 30	\$180
Steam Trap, Industrial Medium Pressure: 30 ≤ psig < 75	\$223
Steam Trap, Industrial High Pressure: 75 ≤ psig < 125	\$276
Steam Trap, Industrial High Pressure: 125 ≤ psig < 175	\$322
Steam Trap, Industrial High Pressure: 175 ≤ psig < 250	\$370
Steam Trap, Industrial High Pressure: 250 ≤ psig	\$418

LOADSHAPE

N/A

COINCIDENCE FACTOR

N/A

Algorithm

CALCULATION OF SAVINGS

ENERGY SAVINGS

ELECTRIC ENERGY SAVINGS

Secondary kWh Savings for Water Supply and Wastewater Treatment

The following savings should be included in the total savings for this measure but should not be included in TRC tests to avoid double counting the economic benefit of water savings. These savings only apply to situations in which steam is lost from the steam system.

$$\Delta kWh_{water} = \Delta Water \text{ (gallons)} / 1,000,000 * E_{water \text{ supply}}$$

Where

$$E_{water \text{ supply}} = \text{Water Supply Energy Factor (kWh/Million Gallons)}$$

$$= 2,571^{748}$$

SUMMER COINCIDENT PEAK DEMAND SAVINGS

N/A

FOSSIL FUEL SAVINGS

$$\Delta Therm = Sa * (Hv + Hs * (T_1 - T_{source})) * \text{Hours} * L / (100,000 * \eta_B)$$

Where:

$$Sa = \text{Steam loss per leaking trap (lbs/hr)}$$

⁷⁴⁷ Ibid.

⁷⁴⁸ This factor include 2571 kWh/MG for water supply based on Illinois energy intensity data from a 2012 ISAWWA study. For more information please review Elevate Energy’s ‘IL TRM: Energy per Gallon Factor, May 2018 paper’. Note since the water loss associated with this measure is due to evaporation and does not discharge into the wastewater system, only the water supply factor is used here.

For systems used in space heating applications that operate at 5 psig or lower, use the following equation to calculate S_a^{749} . The condensate return system pressure, P_2 , will typically be atmospheric pressure, 14.696 psia.

$$S_a = 1519.3 * P_1 * D^2 * [(1/T_1) * (\gamma/(\gamma-1)) * ((P_2/P_1)^{(2/\gamma)} - (P_2/P_1)^{((\gamma+1)/\gamma)})^{0.5} * A * FF$$

For all other steam systems and applications, use the following equation.

$$S_a = 24.24 * P_1 * D^2 * A * FF$$

Defaults are provided in table below if custom calculation is not performed.

Where:

$$1519.3 = \text{Constant, } (s^2 * \text{°R}^{0.5})/(\text{ft} * \text{hr})$$

P_1 = Average steam trap inlet pressure (absolute, psia). If not available, use defaults provided in table below (note that defaults are provided in psig, not psia).

D = Diameter of orifice, inches. Actual value should be used wherever possible as this value has a significant impact on steam flowrate value.

T_1 = Temperature of Saturated Steam (°R)
 $= 507.89 * P_1^{0.0962}$

Where:

$$507.89 = \text{Constant, } \text{°R} * (\text{in}^2/\text{lb}_f)^{0.0962}$$

γ = Heat Capacity Ratio (unitless)
 $= 5.071 * 10^{-4} * P_1 + 1.332$

P_2 = Average steam trap outlet pressure (absolute psia). If unknown, assume atmospheric pressure, 14.696 psia.

A = Adjustment factor
 $= 50\%,^{750}$ all steam systems. This factor accounts for reduction in the maximum theoretical steam flow to the average steam flow (the Enbridge factor).

FF = Flow Factor. In addition to the Adjustment factor (A), an additional 50 percent flow factor adjustment is recommended for medium and high-pressure steam systems to address industrial float and thermostatic style traps where additional blockage is possible.

$$24.24 = \text{Constant } \text{lbm}/(\text{hr-psia-in}^2)$$

Default Steam Loss per Trap (S_a) are provided below for different system types:

⁷⁴⁹ See "Derivation of Equation for Subsonic Compressible Flow through an Orifice and Supporting Calculations for Illinois TRM Steam Trap Measure" paper for more information.

⁷⁵⁰Enbridge adjustment factor used as referenced in CLEAResult "Work Paper Steam Traps Revision #2" Revision 3 dated March 2, 2012 and DOE Federal Energy Management Program Steam Trap Performance Assessment.

Steam System	Average Steam Trap Inlet Pressure (psig) ⁷⁵¹	Diameter of Orifice (in)	Adjustment Factor	Flow Factor	Average Actual Steam Loss per Leaking Trap (lbm/hr/trap) ⁷⁵²
Commercial Dry Cleaners	82.8	0.1250	50%	100%	18.5
Multifamily LPS Space Heating – calculate Sa as provided above. If using default value, cap total savings at 20% of building consumption	-	-	50%	100%	6.9
Commercial LPS Space Heating	11.2	0.2100	50%	100%	13.8
Industrial/Process Low Pressure: psig < 15	11.2	0.2100	50%	100%	13.8
Medium Pressure: 15 ≤ psig < 30	16	0.1875	50%	50%	6.5
Medium Pressure: 30 ≤ psig < 75	47	0.2500	50%	50%	23.4
High Pressure: 75 ≤ psig < 125	101	0.2500	50%	50%	43.8
High Pressure: 125 ≤ psig < 175	146	0.2500	50%	50%	60.9
High Pressure: 175 ≤ psig < 250	202	0.2500	50%	50%	82.1
High Pressure: 250 ≤ psig < 300	263	0.2500	50%	50%	105.2
High Pressure: 300 ≤ psig	Custom	Custom	50%	50%	Calculated

Hv = Heat of vaporization of steam, (Btu/lbm)

Steam System	Average Inlet Pressure (psig)	Heat of Vaporization ⁷⁵³ (Btu/lbm)
Commercial Dry Cleaners	82.8	890
Multifamily LPS Space Heating	--	951
Commercial Space Heating (including Multifamily) LPS	11.2	951
Industrial/Process Low Pressure: psig < 15	11.2	951
Medium Pressure: 15 ≤ psig < 30	16	944
Medium Pressure: 30 ≤ psig < 75	47	915
High Pressure: 75 ≤ psig < 125	101	880
High Pressure: 125 ≤ psig < 175	146	859
High Pressure: 175 ≤ psig < 250	202	837
High Pressure: 250 ≤ psig < 300	263	816
High Pressure: 300 ≤ psig	--	Custom

Hs = Specific heat of water, (Btu/(lbm * °R))

⁷⁵¹Commercial and Industrial low pressure steam trap inlet pressure based on Franklin Energy and Opinion Dynamics analysis of data collected by Armstrong for 120,833 steam traps. Data covered coil, process, and radiator steam trap applications on modulating and constant pressure systems less than 15psi.

Medium and high pressure steam trap inlet pressure based on Navigant analysis of source collected during program implementation by Nicor Gas for GPY1 through GPY4. For each steam trap project, the data provided measure savings description, operating pressure, installation Zip code, business building type, program year, and annual operating hours. Dry cleaning steam trap inlet pressure based on C5 Steam Traps – Nicor FINAL 10.27.11.

⁷⁵² For applications where inlet pressures and orifice diameters are provided in the table, default values are directly calculated using the equation above. For the multifamily LPS space heating applications where inlet pressures and orifice diameters are not provided in the table, default values are assumptions based on engineering judgement and will be revisited in future years.

⁷⁵³ Heat of vaporization of steam at the inlet pressure to the steam trap. Implicit assumption that the average boiler nominal pressure where the vaporization occurs, is essentially that same pressure. Referenced in CLEARResult "Work Paper Steam Traps Revision #2" Revision 3 dated March 2, 2012.

= 1.001

T_{source} = Incoming water temperature

= 513.67°R⁷⁵⁴

η_B = Boiler efficiency

= custom, if unknown:

= 80.7% for steam boilers, except multifamily low-pressure ⁷⁵⁵

= 64.8% for multifamily low-pressure steam boilers ⁷⁵⁶

Hours = Annual hours when steam system is pressurized

= custom, if unknown:

Steam System	Zone (where applicable)	Hours/Yr ⁷⁵⁷
Commercial Dry Cleaners	All Climate Zones	2,425
Industrial/Process Low Pressure: psig < 15		8,282
Medium Pressure: 15 ≤ psig < 30		8,282
Medium Pressure: 30 ≤ psig < 75		8,282
High Pressure: 75 ≤ psig < 125		8,282
High Pressure: 125 ≤ psig < 175		8,282
High Pressure: 175 ≤ psig < 250		8,282
High Pressure: 250 ≤ psig < 300		8,282
High Pressure: 300 ≤ psig		8,282
Commercial Space Heating LPS	Rockford	4,272
	Chicago	4,029
	Springfield	3,406
	Belleville	2,515
	Marion	2,546
Multifamily Space Heating LPS	<p>For steam traps that are part of steam systems where the boiler cycles on/off to maintain space setpoint temperature or for steam traps located downstream of a steam control valve that opens/closes to maintain setpoint temperature, use Heating EFLH values in Section 4.4 for High Rise or Mid-Rise MF buildings.</p> <p>For steam traps that are exposed to steam continuously throughout the heating season, use the values listed above for Commercial Space Heating LPS for your appropriate climate zone.</p>	

L = Leaking & blow-thru

L is 1.0 when applied to the replacment of an individual leaking trap. If a number of steam traps are replaced and the system has not been audited, the leaking and blow-thru is applied to reflect the assumed

⁷⁵⁴ US DOE Building America Program. Building America Analysis Spreadsheet. For Chicago, IL.

⁷⁵⁵ Ibid.

⁷⁵⁶ Katrakis, J. and T.S. Zawacki. "Field-Measured Seasonal Efficiency of Intermediate-sized Low-Pressure Steam Boilers". ASHRAE V99, pt. 2, 1993.

⁷⁵⁷ Medium and high-pressure steam trap annual operating hours based on Navigant analysis of source collected during program implementation by Nicor Gas for GPY1 through GPY4. For each steam trap project, the data provided measure savings description, operating pressure, installation Zip code, business building type, program year, and annual operating hours.

percentage of steam traps that were actually leaking and need to be replaced. A custom value can be utilized if a supported by an evaluation.

Steam System	L (%) ⁷⁵⁸
Custom	Custom
Commercial Dry Cleaners	27%
Commercial Heating (including Multifamily) LPS	27%
Industrial/Process Low Pressure: psig < 15	16%
Medium Pressure: 15 ≤ psig < 30	16%
Medium Pressure: 30 ≤ psig < 75	16%
High Pressure: 75 ≤ psig < 125	16%
High Pressure: 125 ≤ psig < 175	16%
High Pressure: 175 ≤ psig < 250	16%
High Pressure: 250 ≤ psig < 300	16%

For example, a commercial dry cleaning facility with the default hours of operation and boiler efficiency;

$$\Delta\text{Therms} = Sa * (Hv + Hs * (T_1 - T_{\text{source}})) * \text{Hours} * L / (100,000 * \eta_B)$$

$$\begin{aligned} T_1 &= 507.89 * p_1^{0.0962} \\ &= 507.89 * (82.8 + 14.696)^{0.0962} \\ &= 789.1^\circ\text{R} \end{aligned}$$

$$\begin{aligned} \Delta\text{Therms} &= 18.5 \text{ lbs/hr/trap} * (890 \text{ Btu/lb} + 1.001 * (789.1^\circ\text{R} - 513.7^\circ\text{R})) * 2,425\text{hrs} * \\ &27\% / (100,000 * 80.7\%) \\ &= 175.0 \text{ therms per trap} \end{aligned}$$

WATER IMPACT DESCRIPTIONS AND CALCULATION

The hourly water volume saved per each repaired or replaced leaking trap is calculated by dividing the “Average Actual Steam Loss per Leaking Trap (lbm/hr/trap)” by the density of water saved, 8.33 lbm/gal, that replaces the lost steam. The average actual steam loss is provided in the table for parameter *Sa*, the “Average actual steam loss per leaking trap” in the Fossil Fuel Savings section above. Annual water savings are calculated using *Hours* and *L*, the leaking and blow through factor, as defined above.

Water savings only apply to situations where condensate is lost from the steam system. If a condensate recovery system is in place, assume zero water savings or provide a custom calculation based on site-specific operation.

The annual water savings for a replaced or repaired trap is given by:

$$\Delta\text{Water} = \text{GAL} * \text{Hours} * L$$

Where:

GAL = average actual water volume saved per leaking trap, as listed in the following table and based on steam system type.

Other variables as defined above.

⁷⁵⁸Dry cleaners survey data as referenced in CLEAResult “Work Paper Steam Traps Revision #2” Revision 3 dated March 2, 2012.

Steam System*	Average Actual Steam Loss per Leaking Trap (lbm/hr/trap)	GAL: Average Actual Water Volume Saved per Leaking Trap Atmospheric Venting (gal/hr/trap)
Commercial Dry Cleaners	18.5	2.22
Multifamily LPS Space Heating	6.9	0.83
Commercial Heating (including Multifamily) LPS	13.8	1.66
Industrial/Process Low Pressure: psig < 15	13.8	1.66
Medium Pressure: 15 ≤ psig < 30	6.5	0.78
Medium Pressure: 30 ≤ psig < 75	23.4	2.81
High Pressure: 75 ≤ psig < 125	43.8	5.26
High Pressure: 125 ≤ psig < 175	60.9	7.31
High Pressure: 175 ≤ psig < 250	82.1	9.86
High Pressure: 250 ≤ psig < 300	105.2	12.63
High Pressure: 300 ≤ psig	Calculated	Calculated Steam Loss / 8.33

DEEMED O&M COST ADJUSTMENT CALCULATION

N/A

MEASURE CODE: CI-HVC-STRE-V11-250101

REVIEW DEADLINE: 1/1/2028

4.4.17 Variable Speed Drives for HVAC Pumps and Cooling Tower Fans

DESCRIPTION

This measure is applied to variable speed drives (VSD) which are installed on the following HVAC system applications: chilled water pump, hot water pumps and cooling tower fans. There is a separate measure for HVAC supply and return fans. All other VSD applications require custom analysis by the program administrator. The VSD will modulate the speed of the motor when it does not need to run at full load. Since the power of the motor is proportional to the cube of the speed for these types of applications, significant energy savings will result.

This measure is not applicable for:

- Cooling towers, chilled or hot water pumps with any process load.
- VSD installation in existing cooling towers with 2-speed motors. (current code requires 2-speed motors for cooling towers with motors greater than 7.5 HP)
- VSD installation in new cooling towers with motors greater than 7.5 HP

This measure was developed to be applicable to the following program types: TOS, RF. If applied to other program types, the measure savings should be verified.

DEFINITION OF EFFICIENT EQUIPMENT

The VSD is applied to a motor which does not have a VSD. This measure is not applicable for replacing failed VSDs. The application must have a variable load and installation is to include the necessary controls. Savings are based on application of VSDs to a range of baseline load conditions including no control, inlet guide vanes, outlet guide vanes and throttling valves.

DEFINITION OF BASELINE EQUIPMENT

The time of sale baseline is a new motor installed without a VSD or other methods of control. Retrofit baseline is an existing motor operating as is. Retrofit baselines may or may not include guide vanes, throttling valves or other methods of control. This information shall be collected from the customer.

Installations of new equipment with VSDs which are required by IECC, state energy code as adopted by the State of Illinois are not eligible for incentives. As code requirements and adoption can differ from municipality to municipality, the user should verify which version of code is applicable given these constraints.

Note, IECC 2021 became effective statewide as of 1/1/2024. IECC 2018 is the requisite code for any projects with permitting dates spanning July 1, 2019 to the 12/31/2023. Prior to July 1, 2019, IECC 2015 is the applicable code.

DEEMED LIFETIME OF EFFICIENT EQUIPMENT

The expected measure life for HVAC application is 15 years;⁷⁵⁹ measure life for process is 15 years.⁷⁶⁰

DEEMED MEASURE COST

Customer provided costs will be used when available. Default measure costs⁷⁶¹ are noted below for up to 75 hp motors. Custom costs must be gathered from the customer for motor sizes not listed below.

⁷⁵⁹ ComEd Effective Useful Life Research Report (2018), Navigant, May 14, 2018

⁷⁶⁰ California Public Utilities Commission (CPUC), Energy Division. 2014. "DEER2014-EUL-table-update_2014-02-05.xlsx"

⁷⁶¹ NEEP Incremental Cost Study Phase Two Final Report dated January 13, 2013 (pg. 32; Table 15). Equipment and labor costs were extrapolated or interpolated as necessary for motor sizes not covered in the incremental cost study.

HP	Cost
5 HP	\$2,250
7.5 HP	\$2,517
10 HP	\$2,784
15 HP	\$3,318
20 HP	\$3,852
25 HP	\$4,386
50 HP	\$6,573
75 HP	\$8,532

LOADSHAPE

- Loadshape C42 - VFD - Boiler feedwater pumps <10 HP
- Loadshape C43 - VFD - Chilled water pumps <10 HP
- Loadshape C44 - VFD Boiler circulation pumps <10 HP
- Loadshape C48 - VFD Boiler draft fans <10 HP
- Loadshape C49 - VFD Cooling Tower Fans <10 HP

COINCIDENCE FACTOR

The demand savings factor (DSF) is already based upon coincident savings, and thus there is no additional coincidence factor for this characterization.

Algorithm

CALCULATION OF SAVINGS

ELECTRIC ENERGY SAVINGS

$$\Delta kWh = BHP / EFFi * Hours * ESF$$

Where:

BHP = System Brake Horsepower
(Nominal motor HP * Motor load factor)

Motors are assumed to have a load factor of 65% for calculating kW if actual values cannot be determined⁷⁶². Custom load factor may be applied if known.

EFFi = Motor efficiency, installed. Actual motor efficiency shall be used to calculate kW. If not known, default motor is a NEMA Premium Efficiency, ODP, 4-pole/1800 RPM fan motor, as detailed in the table below.

⁷⁶² Del Balso, Ryan J. "Investigation into the Reliability of Energy Efficiency/Demand Side Management Savings Estimates for Variable Frequency Drives in Commercial Applications", University of Colorado, Department of Civil, Environmental and Architectural Engineering, 2013.

NEMA Premium Efficiency Motors Default Efficiencies⁷⁶³

Size HP	Open Drip Proof (ODP)			Totally Enclosed Fan-Cooled (TEFC)		
	# of Poles			# of Poles		
	6	4	2	6	4	2
	Speed (RPM)			Speed (RPM)		
	1200	1800 Default	3600	1200	1800	3600
1	0.825	0.855	0.770	0.825	0.855	0.770
1.5	0.865	0.865	0.840	0.875	0.865	0.840
2	0.875	0.865	0.855	0.885	0.865	0.855
3	0.885	0.895	0.855	0.895	0.895	0.865
5	0.895	0.895	0.865	0.895	0.895	0.885
7.5	0.902	0.910	0.885	0.910	0.917	0.895
10	0.917	0.917	0.895	0.910	0.917	0.902
15	0.917	0.930	0.902	0.917	0.924	0.910
20	0.924	0.930	0.910	0.917	0.930	0.910
25	0.930	0.936	0.917	0.930	0.936	0.917
30	0.936	0.941	0.917	0.930	0.936	0.917
40	0.941	0.941	0.924	0.941	0.941	0.924
50	0.941	0.945	0.930	0.941	0.945	0.930
60	0.945	0.950	0.936	0.945	0.950	0.936
75	0.945	0.950	0.936	0.945	0.954	0.936
100	0.950	0.954	0.936	0.950	0.954	0.941
125	0.950	0.954	0.941	0.950	0.954	0.950
150	0.954	0.958	0.941	0.958	0.958	0.950
200	0.954	0.958	0.950	0.958	0.962	0.954
250	0.954	0.958	0.950	0.958	0.962	0.958
300	0.954	0.958	0.954	0.958	0.962	0.958
350	0.954	0.958	0.954	0.958	0.962	0.958
400	0.958	0.958	0.958	0.958	0.962	0.958
450	0.962	0.962	0.958	0.958	0.962	0.958
500	0.962	0.962	0.958	0.958	0.962	0.958

Hours = Default hours are provided for HVAC applications which vary by HVAC application and building type⁷⁶⁴. When available (provided via Energy Management Software or metered), actual hours should be used.

Building Type	Heating Run Hours	Cooling Run Hours	Model Source
Assembly	4888	2150	eQuest
Assisted Living	4711	4373	eQuest
Auto Dealership	5270	1605	OpenStudio
College	7005	4065	OpenStudio
Convenience Store	4136	2084	eQuest

⁷⁶³ Douglass, J. (2005). Induction Motor Efficiency Standards. Washington State University and the Northwest Energy Efficiency Alliance, Extension Energy Program, Olympia, WA, October 2005.

⁷⁶⁴ Hours per year are estimated using the eQuest or OpenStudio models as the total number of hours the heating or cooling system is operating for each building type. "Heating and Cooling Run Hours" are estimated as the total number of hours fans are operating for heating, cooling and ventilation for each building type. This may overclaim certain applications (e.g. pumps) and so where possible actual hours should be used for these applications.

Building Type	Heating Run Hours	Cooling Run Hours	Model Source
Drug Store	4940	1708	OpenStudio
Elementary School	6028	2649	OpenStudio
Emergency Services	3936	3277	OpenStudio
Garage	4849	2102	eQuest
Grocery	7452	5470	OpenStudio
Healthcare Clinic	8760	6364	OpenStudio
High School	5480	3141	eQuest
Hospital - VAV econ	8107	8707	OpenStudio
Hospital - CAV econ	3045	2336	OpenStudio
Hospital - CAV no econ	2927	4948	OpenStudio
Hospital - FCU	4371	8760	OpenStudio
Manufacturing Facility	3821	2805	eQuest
MF - High Rise	5168	6823	OpenStudio
MF - Mid Rise	6011	4996	OpenStudio
Hotel/Motel - Guest	5632	4155	OpenStudio
Hotel/Motel - Common	6340	6227	OpenStudio
Movie Theater	5063	2120	eQuest
Office - High Rise - VAV econ	5646	3414	OpenStudio
Office - High Rise - CAV econ	5361	4849	eQuest
Office - High Rise - CAV no econ	4202	6049	OpenStudio
Office - High Rise - FCU	4600	5341	OpenStudio
Office - Low Rise	3834	3835	OpenStudio
Office - Mid Rise	6119	3040	OpenStudio
Religious Building	5199	2830	eQuest
Restaurant	3476	2305	OpenStudio
Retail - Department Store	4249	2528	eQuest
Retail - Strip Mall	4475	2266	eQuest
Warehouse	4606	770	eQuest
Unknown	5038	2987	n/a

The type of hours to apply depends on the VFD application, according to the table below.

Application	Hours Type
Hot Water Pump	Heating
Chilled Water Pump	Cooling
Cooling Tower Fan	Cooling

ESF = Energy savings factor varies by VFD application. Units are kW/HP.

Application	ESF ⁷⁶⁵
Hot Water Pump	0.249
Chilled Water Pump	0.081
Cooling Tower Fan	0.502

SUMMER COINCIDENT PEAK DEMAND SAVINGS

$$\Delta kW = BHP/EFFi * DSF$$

⁷⁶⁵ Based on OpenStudio Large Office model, finding difference in energy use for each VSD application. See 'VSD ESF Calculation.xls'.

Where:

DSF = Demand Savings Factor varies by VFD application.⁷⁶⁶ Units are kW/HP. Values listed below are based on typical peak load for the listed application.

Application	DSF
Hot Water Pump	0
Chilled Water Pump	0
Cooling Tower Fan	0.407

FOSSIL FUEL IMPACT DESCRIPTIONS AND CALCULATION

There are no expected fossil fuel impacts for this measure.

WATER IMPACT DESCRIPTIONS AND CALCULATION

N/A

DEEMED O&M COST ADJUSTMENT CALCULATION

N/A

MEASURE CODE: CI-HVC-VSDHP-V11-250101

REVIEW DEADLINE: 1/1/2028

⁷⁶⁶Based on OpenStudio Large Office model, finding difference in maximum demand for each VSD application. See 'VSD ESF Calculation.xls'.

4.4.18 Small Commercial Programmable Thermostats – Retired 12/31/2019. Replaced with
4.4.48 Small Commercial Thermostats

4.4.19 Demand Controlled Ventilation

DESCRIPTION

Demand control ventilation (DCV) adjusts outside ventilation air based on the number of occupants and the ventilation demands that those occupants create. DCV is part of a building's ventilation system control strategy. It may include hardware, software, and controls as an integral part of a building's ventilation design. Active control of the ventilation system provides the opportunity to reduce heating and cooling energy use.

The primary component is a control sensor to communicate either directly with the economizer or with a central computer. The component is most typically a carbon dioxide (CO₂) sensor, occupancy sensor, or turnstile counter. This measure is applicable to multiple building types, and savings are classified by the specific building types defined in the Illinois TRM. This measure is modeled to assume night time set backs are in operation and minimum outside air is being used when the building is unoccupied. Systems that have static louvers or that are open at night will likely have greater savings by using the custom program.

Demand controlled ventilation controls can also be added to the exhaust fans to enclosed parking garages. The fans modulate the ventilation airflow based on pollutant concentrations (primarily carbon monoxide) in the space.

This measure does not apply to packaged single-zone (PSZ) rooftop units with functioning economizers. For PSZ with functioning economizers, see 4.4.41 Advanced Rooftop Controls.

This measure was developed to be applicable to the following program types: RF. If applied to other program types, the measure savings should be verified.

DEFINITION OF EFFICIENT EQUIPMENT

The efficient equipment condition is defined by new CO₂ sensors installed on return air systems where no other sensors were previously installed. For heating savings, this measure does not apply to any system with terminal reheat (constant volume or variable air volume). For terminal reheat system a custom savings calculation should be used.

DEFINITION OF BASELINE EQUIPMENT

The base case for this measure is a space with no demand control capability. The current code minimum for outside air (OA) is 5 CFM per occupant (ASHRAE 62.1 - 2016) which is the value for office space assumed in this measure.

This measure does not apply to packaged single-zone (PSZ) rooftop units with functioning economizers. For PSZ with functioning economizers, see 4.4.41 Advanced Rooftop Controls.

DEEMED LIFETIME OF EFFICIENT EQUIPMENT

The deemed measure life is 10 years and based on CO₂ sensor estimated life.⁷⁶⁷

DEEMED MEASURE COST

The deemed measure cost is assumed to be the full cost of installation of a DCV retrofit including sensor cost (\$278) and RTU integration cost(\$900per zone) for a total of \$1,178.⁷⁶⁸

⁷⁶⁷ During conversations with vendors and Building Automation System (BAS) contractors, it was determined that sensors must be functional for up to 10 years. It is recommended that they are part of a normal preventive maintenance program in which calibration is an important part of extending useful life. Although they are not subject to mechanical failure, they do fall out of tolerance over time.

⁷⁶⁸ [Business Energy Advisor | Demand-Controlled Ventilation \(bizenergyadvisor.com\)](https://www.bizenergyadvisor.com), 2017. Average sensor cost used from list of eight different vendors and CO₂ sensors. RTU integration costs assume high end of estimated range (\$300-\$900) for implementing DCV on a newer DCV-ready RTU with existing economizer.

Adding demand controlled ventilation to parking garages is assumed to cost \$500 per sensor including the cost of the controller. The installation cost is estimated at \$1,000 for labor.⁷⁶⁹

LOADSHAPE

Commercial ventilation C23

COINCIDENCE FACTOR

N/A

Algorithm

CALCULATION OF ENERGY SAVINGS

ELECTRIC ENERGY SAVINGS

For facilities heated by natural gas,

$$\Delta kWh = \text{Condition Space}/1000 * SF_{cooling}$$

For facilities heated by heat pumps,

$$\Delta kWh = \text{Condition Space}/1000 * SF_{cooling} + \text{Condition Space}/1000 * SF_{Heat HP}$$

For facilities heated by electric resistance,

$$\Delta kWh = \text{Condition Space}/1000 * SF_{cooling} + \text{Condition Space}/1000 * SF_{Heat ER}$$

Where:

- Conditioned Space = actual square footage of conditioned space controlled by sensor
- SF_{cooling} = Cooling Savings Factor
= value in table below based on building type and weather zone
- SF_{Heat HP} = Heating Savings factor for facilities heated by Heat Pump (HP)
= value in table below based on building type and weather zone
- SF_{Heat ER} = Heating Savings factor for facilities heated by Electric Resistance (ER)
= value in table below based on building type and weather zone

Saving Factor Tables⁷⁷⁰

Building Type	SF _{cooling} (kWh/1000 SqFt)				
	Zone 1 (Rockford)	Zone 2 (Chicago)	Zone 3 (Springfield)	Zone 4 (Belleville)	Zone 5 (Marion)
Office - Low-rise	285	289	299	298	305
Office - Mid-rise	225	228	234	233	237
Office - High-rise	267	271	279	279	284
Religious Building	763	780	886	889	910
Restaurant	498	510	573	593	615

⁷⁶⁹ California Utilities Statewide Codes and Standards Team. 2011. "2013 California Building Energy Efficiency Standards", Garage Exhaust, Section 4.2 Page 14.

⁷⁷⁰ The electric energy savings was calculated using TMY3 weather data and methodology consistent with ASHRAE standards. Savings are calculated on an annual basis for each given temperature zone in Illinois. Energy savings for DCV were developed utilizing standards, inputs and approaches as set forth by ASHRAE 90.1 -2010 (code level up until Dec 31, 2015). Building input parameters like square footage, equipment efficiencies and occupancy match those used in the EFLH calculations. Reference calculation found in Demand Control Ventilation 12-30-13.xls.

Building Type	SF _{cooling} (kWh/1000 SqFt)				
	Zone 1 (Rockford)	Zone 2 (Chicago)	Zone 3 (Springfield)	Zone 4 (Belleville)	Zone 5 (Marion)
Retail - Department Store	388	393	410	415	423
Retail - Strip Mall	269	272	285	285	290
Convenience Store	355	357	368	370	374
Elementary School	358	367	410	405	415
High School	350	359	401	396	406
College/University	400	426	472	488	519
Healthcare Clinic	349	354	389	392	398
Lodging	407	409	423	424	428
Manufacturing	175	177	183	248	185
Special Assembly Auditorium	563	581	668	677	711
Default (non-garage)	377	385	419	426	433
Enclosed Parking Garage ⁷⁷¹	925	925	925	925	925

Building Type	SF _{Heat HP} (kWh/1000 SqFt)				
	Zone 1 (Rockford)	Zone 2 (Chicago)	Zone 3 (Springfield)	Zone 4 (Belleville)	Zone 5 (Marion)
Office - Low-rise	234	205	181	171	147
Office - Mid-rise	157	138	121	115	99
Office - High-rise	211	185	163	154	133
Religious Building	1,508	1,333	1,180	1,125	1,008
Restaurant	1,067	962	837	816	720
Retail - Department Store	368	329	291	285	249
Retail - Strip Mall	246	215	195	186	165
Convenience Store	180	163	141	138	121
Elementary School	657	572	508	473	418
High School	641	558	495	461	406
College/University	1,267	1,114	980	945	798
Healthcare Clinic	447	396	348	334	299
Lodging	205	184	159	154	135
Manufacturing	130	114	101	172	83
Special Assembly Auditorium	1,773	1,564	1,414	1,378	1,212
Default (non-garage)	606	535	474	460	400

Building Type	SF _{Heat ER} (kWh/1000 SqFt)				
	Zone 1 (Rockford)	Zone 2 (Chicago)	Zone 3 (Springfield)	Zone 4 (Belleville)	Zone 5 (Marion)
Office - Low-rise	703	615	542	512	441
Office - Mid-rise	471	413	364	345	298
Office - High-rise	633	554	489	462	398
Religious Building	4,523	3,999	3,541	3,376	3,024
Restaurant	3,201	2,886	2,511	2,449	2,159
Retail - Department Store	1,103	987	874	855	748
Retail - Strip Mall	738	646	584	559	495

⁷⁷¹ Savings are estimated based on a study done by California Utilities Statewide Codes and Standards Team, “2013 California Building Energy Efficiency Standards”, 2013, Section 2.4, Table 1. The savings are primarily fan savings, and are not dependent on climate zone.

Building Type	SF _{Heat ER} (kWh/1000 SqFt)				
	Zone 1 (Rockford)	Zone 2 (Chicago)	Zone 3 (Springfield)	Zone 4 (Belleville)	Zone 5 (Marion)
Convenience Store	541	488	423	413	364
Elementary School	1,972	1,715	1,523	1,420	1,254
High School	1,924	1,673	1,484	1,383	1,219
College/University	3,801	3,341	2,940	2,834	2,394
Healthcare Clinic	1,341	1,188	1,044	1,001	896
Lodging	616	551	477	462	406
Manufacturing	390	343	303	516	250
Special Assembly Auditorium	5,320	4,691	4,243	4,133	3,636
Default (non-garage)	1,819	1,606	1,423	1,381	1,199

For example, for a 7,500 SqFt of low-rise office space in Chicago with gas heat.

$$\begin{aligned} \Delta kWh &= 7,500 / 1000 * 289 \\ &= 2,168 \text{ kWh} \end{aligned}$$

SUMMER COINCIDENT PEAK DEMAND SAVINGS

NA

FOSSIL FUEL SAVINGS

$$\Delta \text{therms} = \text{Condition Space} / 1000 * SF_{\text{Heat Gas}}$$

Where:

SF_{Heat Gas} = value in table below based on building type and weather zone.⁷⁷²

Building Type	SF _{Heat Gas} (Therm/1000 sq ft)				
	Zone 1 (Rockford)	Zone 2 (Chicago)	Zone 3 (Springfield)	Zone 4 (Belleville)	Zone 5 (Marion)
Office - Low-rise	30	26	23	22	19
Office - Mid-rise	20	18	16	15	13
Office- High-rise	27	24	21	20	17
Religious Building	193	171	151	144	129
Restaurant	137	123	107	104	92
Retail - Department Store	47	42	37	36	32
Retail - Strip Mall	31	28	25	24	21
Convenience Store	23	21	18	18	16
Elementary School	84	73	65	61	53
High School	82	71	63	59	52
College/ University	162	143	125	121	102
Healthcare Clinic	57	51	45	43	38
Lodging	26	23	20	20	17
Manufacturing	17	15	13	22	11
Special Assembly Auditorium	227	200	181	176	155
De-fault	78	68	61	59	51

⁷⁷² The natural gas energy savings was calculated using TMY3 weather data and methodology consistent with ASHRAE standards. Savings are calculated on an annual basis for each given temperature zone in Illinois. Energy savings for DCV were developed utilizing standards, inputs and approaches as set forth by ASHRAE 62.1 and 90.1, respectively. Building input parameters like square footage, equipment efficiencies and occupancy match those used in the EFLH calculations. Reference calculation found in Demand Control Ventilation 12-30-13.xls.

For example, for a 7500 SqFt of low-rise office space in Chicago.

$$\begin{aligned}\Delta\text{Therms} &= 7,500/1,000 * 26 \\ &= 195 \text{ Therms}\end{aligned}$$

WATER IMPACT DESCRIPTIONS AND CALCULATION

N/A

DEEMED O&M COST ADJUSTMENT CALCULATION

N/A

MEASURE CODE: CI-HVC-DCV-V07-240101

REVIEW DEADLINE: 1/1/2027

4.4.20 High Turndown Burner for Space Heating Boilers

DESCRIPTION

This measure is for a non-residential boilers equipped with linkageless controls providing space heating with burners having a turndown less than 6:1.⁷⁷³ Turndown is the ratio of the high firing rate to the low firing rate. When boilers are subjected to loads below the low firing rate, the boiler must cycle on/off to meet the load requirements. A higher turndown ratio reduces burner startups, provides better load control, saves wear-and-tear on the burner, and reduces purge-air requirements, all of these benefits result in better overall efficiency.

This measure was developed to be applicable to the following program types: NC, TOS, RF.

If applied to other program types, the measure savings should be verified.

DEFINITION OF EFFICIENT EQUIPMENT

To qualify the boiler linkageless burner must operate with a turndown greater than or equal to 10:1 and be subjected to loads less than or equal to 30% of the full fire input MBH⁷⁷⁴ for greater than 60% of the operating hours.⁷⁷⁵

DEFINITION OF BASELINE EQUIPMENT

The baseline boiler utilizes a linkageless burner with a turndown ration of 6:1 or less and is used primarily for space heating. Redundant boilers do not qualify. Code requirements must be considered.

Note: beginning with the 2015 edition, and continuing through the 2021 edition, IECC makes the following requirements for boiler turndown:

Boiler Systems with design input of greater than 1,000,000 Btu/h shall comply with the turndown ratio specified in the following table.

The system turndown requirement shall be met through the use of multiple single-input boilers, one or more *modulating boilers* or a combination of single-input and *modulating boilers*.

BOILER SYSTEM DESIGN INPUT	MINIMUM TURNDOWN RATIO
≥ 1,000,000 and less than or equal to 5,000,000	3 to 1
> 5,000,000 and less than or equal to 10,000,000	4 to 1
> 10,000,000	5 to 1

DEEMED LIFETIME OF EFFICIENT EQUIPMENT

The expected measure life is assumed to be the lower of remaining useful life of the boiler, or 21 years.⁷⁷⁶

DEEMED MEASURE COST

Actual costs shall be used as available. When unknown, the deemed installed measure cost including labor is approximately \$2.53/MBtu/hr.⁷⁷⁷

⁷⁷³ The standard turndown ratio for boilers is 6:1. Understanding Fuel Savings in the Boiler Room, ASHRAE Journal, David Eoff, December, 2008 p 38.

⁷⁷⁴ Focus on Energy Evaluation, Business Programs: Deemed Savings Manual V1.0, March 22, 2010. This factor implies that boilers are 30% oversized on average.

⁷⁷⁵ FES Analysis of bin hours based upon a 30% oversizing factor.

⁷⁷⁶ "American Society of Heating, Refrigeration, and Air-Conditioning Engineers, Inc. ASHRAE Handbook, HVAC Applications. Chapter 38, "Owning and Operating Costs", Table 4. 2019.

⁷⁷⁷ FES review of PY2/PY3 costs for custom People's and North Shore high turndown burner projects. See High Turndown Costs.xlsx for details.

DEEMED O&M COST ADJUSTMENTS

N/A

LOADSHAPE

N/A

COINCIDENCE FACTOR

N/A

Algorithm

CALCULATION OF SAVINGS

ELECTRIC ENERGY SAVINGS

N/A

SUMMER COINCIDENT PEAK DEMAND SAVINGS

N/A

FOSSIL FUEL SAVINGS

$$\Delta\text{therms} = \text{Ngi} * \text{SF} * \text{EFLH} / 100$$

Where:

- Ngi = Boiler gas input size (kBtu/hr) = custom
- SF = Savings Factor, based on the percentage of energy loss per hour
 $= (\sum ((\text{EL_base} - \text{EL_eff}) * \text{H_cycling})) / \text{H}) * 100$

Where:

EL_base = Base Boiler Percentage of energy loss due to cycling at % of Base Boiler Load where
 BL_base ≤ TDR_base

$$= 0.003 * (\text{Cycles_base})^2 - 0.001 * \text{Cycles_base}^{778}$$

Where:

$$\begin{aligned} \text{Cycles_base} &= \text{Number of Cycles/hour of base boiler} \\ &= \text{TDR_base} / \text{BL} \end{aligned}$$

Where:

BL = % of full boiler load at bin hours being evaluated. This is assumed to be a straight line based on 0% load at the building balance point (assumed to be 55F), and full load corrected for the oversizing (OSF) at the lowest temperature bin of -10 to -5F. (See table below for summary of values at different temperature bins.)

$$\text{OSF} = \text{Oversizing Factor} = 1.3,^{779} \text{ or custom}$$

⁷⁷⁸ Release 3.0 Operations & Maintenance Best Practices A Guide to Achieving Operational Efficiency, August 2010, Federal Energy Management Program, US Department of Energy. The equation was determined by plotting the values in Table 9.2.1 – Boiler Cycling Energy Loss.

⁷⁷⁹ PA Consulting, KEMA, Focus on Energy Evaluation, Business Programs: Deemed Savings Manual V1.0, March 22, 2010, Page 4-12.

TDR_base = Turndown ratio = 0.33,⁷⁸⁰ or custom

EL_eff = Efficient Boiler Percentage of energy loss due to cycling at % of Efficient Boiler Load
 = 0.003 * (Cycles_eff)² – 0.001 * Cycles_eff

Where:

Cycles_eff = Number of Cycles/hour
 = TDR_eff / BL

Where:

TDR_eff = Turndown ratio = 0.10,⁷⁸¹ or custom

H_cycling = Hours base boiler is cycling at % of base boiler load
 = see table below or custom

H = Total Number of Hours in Heating Season
 = 4,725⁷⁸² or custom

100 = convert to a percentage

SF = 65.7 / 4725 * 100 = 1.4% or custom (see table below for summary of values)

Temperature	H_cycling	BL	EL_base	EL_eff	(EL_base-EL_eff)* Hours Cycling
50 to 55	574	6.0%	8.5%	0.7%	44.5
45 to 50	576	12.0%	2.0%	0.0%	11.5
40 to 45	435	18.0%	0.8%	0.0%	3.5
35 to 40	884	24.0%	0.4%	0.0%	3.5
30 to 35	778	30.0%	0.3%	0.0%	2.3
Total					65.7

EFLH = Equivalent Full Load Hours for heating in Existing Buildings or New Construction are provided in section 4.4 HVAC End Use.

100 = convert kBtu to therms

Water IMPACT DESCRIPTIONS AND CALCULATION

N/A

DEEMED O&M COST ADJUSTMENT CALCULATION

N/A

MEASURE CODE: CI-HVC-HTBC-V07-250101

REVIEW DEADLINE: 1/1/2028

⁷⁸⁰ Ibid.

⁷⁸¹ 10:1 ratio used to qualify for efficient equipment.

⁷⁸² TMYx weather data for the weighted average heating hours for the state of Illinois

4.4.21 Linkageless Boiler Controls for Space Heating

DESCRIPTION

This measure is for a non-residential boiler providing space heating with single point positioning combustion control. In single-point positioning control, the fuel valve is linked to the combustion air damper via a jackshaft mechanism to maintain correspondence between fuel and combustion air input. Most boilers with single point positioning control do not maintain low excess air levels over their entire firing range. Generally, these boilers are calibrated at high fire, but due to the non-linearity required for efficient combustion, excess air levels tend to dramatically increase as the firing rate decreases. Boiler efficiency drops as the excess air levels are increased.

This measure was developed to be applicable to the following program types: TOS, NC, RF. If applied to other program types, the measure savings should be verified.

DEFINITION OF EFFICIENT EQUIPMENT

To qualify the boiler burner must have a linkageless control system allowing the combustion air damper position to be adjusted and set for optimal efficiency at several firing rates throughout the burner’s firing range. This requires the fuel valve and combustion air damper to each be powered by a separate actuator. An alternative to the combustion air damper is a Variable Speed Drive on the combustion air fan.

DEFINITION OF BASELINE EQUIPMENT

The baseline boiler utilizes single point positioning for the burner combustion control.

DEEMED LIFETIME OF EFFICIENT EQUIPMENT

The expected measure life is assumed to be 20 years.⁷⁸³

DEEMED MEASURE COST

The deemed measure cost is estimated at \$8,500.⁷⁸⁴

DEEMED O&M COST ADJUSTMENTS

N/A

LOADSHAPE

N/A

COINCIDENCE FACTOR

N/A

Algorithm

CALCULATION OF SAVINGS

ELECTRIC ENERGY SAVINGS

When a Variable Speed Drive is incorporated, electrical savings are calculated according to the “4.4.17 Variable Speed Drive for HVAC Pumps and Cooling Tower Fans” measure.

⁷⁸³ Ontario Energy Board, “Final Report: Custom Measure Life”, Michaels Energy, May 10, 2018, burner modification measure life is estimated at 20 years.

⁷⁸⁴ Codes and Standards Enhancement Initiative (CASE) – Commercial Boilers; 2013 California Building Energy Efficiency Standards, California Utilities Statewide Codes and Standards Team, October 2011 (pg. 19). The estimated incremental costs were provided by boiler control representatives and did not vary with boiler capacity. The \$8,500 estimated incremental cost represents the mid-point of the estimated price range.

SUMMER COINCIDENT PEAK DEMAND SAVINGS

N/A

FOSSIL FUEL SAVINGS

$$\Delta\text{Therms} = \text{Ngi} * \text{SF} * \text{EFLH} / 100$$

Where:

Ngi = Boiler gas input size (kBtu/hr) = custom

SF = Savings factor

Note: Savings factor is the percentage increase in efficiency as a result of the addition of linkageless burner controls. At an average boiler load of 35%, single point controls are assumed to have excess air of 91%, while linkageless controls are assumed to have 34% excess air.⁷⁸⁵ The difference between controls types is 57% at this average operating condition. A 15% reduction in excess air is approximately a 1% increase in efficiency.⁷⁸⁶ Therefore the nominal combustion efficiency increase is $57 / 15 * 1\% = 3.8\%$.

$$= 3.8\%$$

EFLH = Equivalent Full Load Hours for heating in Existing Buildings or New Construction are provided in section 4.4 HVAC End Use

100 = convert kBtu to therms

WATER IMPACT DESCRIPTIONS AND CALCULATION

N/A

DEEMED O&M COST ADJUSTMENT CALCULATION

N/A

MEASURE CODE: CI-HVC-LBC-V06-220101

REVIEW DEADLINE: 1/1/2027

⁷⁸⁵ Available and Emerging Technologies for Reducing Greenhouse Gas Emissions from Industrial, Commercial, and Institutional Boilers, Prepared by the Sector Policies and Programs Division Office of Air Quality Planning and Standards U.S. Environmental Protection Agency Research Triangle Park, North Carolina 27711, October 2010, Table 1. ICI Boilers – Summary of Greenhouse Gas Emission Reduction Measures, pg. 8.

⁷⁸⁶ Department of Energy (DOE). January 2012, Steam Tip Sheet #4, Improve Your Boiler’s Combustion Efficiency. Advanced Manufacturing Office. Washington, DC: U.S. Department of Energy. This value was determined as an appropriate average over the stack temperatures and excess air levels indicated.

4.4.22 Oxygen Trim Controls for Space Heating Boilers

DESCRIPTION

This measure is for a non-residential boiler providing space heating without oxygen trim combustion controls. Oxygen (O₂) trim controls limit the amount of excess oxygen provided to the burner for combustion. This oxygen level is dependent upon the amount of air provided. Oxygen trim control converts parallel positioning, linkageless controls, into a closed-loop control configuration with the addition of an exhaust gas analyzer and PID controller. Boilers with oxygen trim controls can maintain a predetermined excess air rate (generally 15% to 30% excess air) over the entire burner firing rate. Boilers without these controls typically have excess air rates around 30% over the entire firing rate. Boiler efficiency drops as the excess air levels are increased.

This measure was developed to be applicable to the following program types: NC, TOS, RF.

If applied to other program types, the measure savings should be verified.

DEFINITION OF EFFICIENT EQUIPMENT

To qualify the boiler burner must have an oxygen control system allowing the combustion air to be adjusted to maintain a predetermined excess oxygen level in the flue exhaust at all firing rates throughout the burner’s firing range. This requires an oxygen sensor in the flue exhaust and linkageless fuel valve and combustion air controls.

DEFINITION OF BASELINE EQUIPMENT

The baseline boiler utilizes single point positioning for the burner combustion control.

DEEMED LIFETIME OF EFFICIENT EQUIPMENT

The measure life for the O₂ Trim controls is 20 years.⁷⁸⁷

DEEMED MEASURE COST

The deemed measure cost is approximately \$23,250.⁷⁸⁸

LOADSHAPE

N/A

COINCIDENCE FACTOR

N/A

Algorithm

CALCULATION OF SAVINGS

ELECTRIC ENERGY SAVINGS

N/A

SUMMER COINCIDENT PEAK DEMAND SAVINGS

N/A

FOSSIL FUEL SAVINGS

$$\Delta\text{Therms} = N_{gi} * SF * EFLH / 100$$

⁷⁸⁷ Ontario Energy Board, “Final Report: Custom Measure Life”, Michaels Energy, May 10, 2018, burner modification measure life is estimated at 20 years.

⁷⁸⁸ CODES AND STANDARDS ENHANCEMENT INITIATIVE (CASE) PROCESS BOILERS, 2013 California Building Energy Efficiency Standards, California Utilities Statewide Codes and Standards Team, October 2011, pg. 22.

Where:

Ng_i = Boiler gas input size (kBtu/hr)
= Custom

SF = Savings factor

Note: Savings factor is the percentage reduction in gas consumption as a result of the addition of O₂ trim controls. Linkageless controls have an excess air rate of 28% over the entire firing range.⁷⁸⁹ O₂ trim controls have an excess air rate of 15%.⁷⁹⁰ The average difference is 13%. A 15% reduction in excess air is approximately a 1% increase in efficiency.⁷⁹¹ Therefore, the nominal combustion efficiency increase is $13 / 15 * 1\% = 0.87\%$.

= 0.87%

EFLH = Default Equivalent Full Load Hours for heating in Existing Buildings or New Construction are provided in section 4.4 HVAC End Use. When available, actual hours should be used.

100 = convert kBtu to therms

WATER IMPACT DESCRIPTIONS AND CALCULATION

N/A

DEEMED O&M COST ADJUSTMENT CALCULATION

The deemed annual Operations and Maintenance cost is \$800.⁷⁹²

MEASURE CODE: CI-HVC-O2TC-V02-220101

REVIEW DEADLINE: 1/1/2026

⁷⁸⁹ Department of Energy (DOE). 2009. Energy Matters newsletter. Fall 2009- Vol. 1, Iss. 1. Washington, DC: U.S. Department of Energy, Office of Energy Efficiency and Renewable Energy, Industrial Technologies Program.

⁷⁹⁰ Ibid.

⁷⁹¹ Department of Energy (DOE), January 2012, Steam Tip Sheet #4, Improving Your Boiler's Combustion Efficiency. Advanced Manufacturing Office. Washington, DC: U.S. Department of Energy. This value was determined as an appropriate average over the stack temperatures and excess air levels indicated.

⁷⁹² CODES AND STANDARDS ENHANCEMENT INITIATIVE (CASE) PROCESS BOILERS, 2013 California Building Energy Efficiency Standards, California Utilities Statewide Codes and Standards Team, October 2011, pg. 22.

4.4.23 Shut Off Damper for Space Heating Boilers or Furnaces

DESCRIPTION

This measure is for non-residential atmospheric boilers or furnaces providing space heating without a shut off damper. When appliances are on standby mode warm room air is drawn through the stack via the draft hood or dilution air inlet at a rate proportional to the stack height, diameter and outdoor temperature. More air is drawn through the vent immediately after the appliance shuts off and the flue is still hot. Installation of a new shut off damper can prevent heat from being drawn up the warm vent and reducing the amount of air that passes through the furnace or boiler heat exchanger. This reduction in air can slightly increase overall operating efficiency by reducing the time needed to achieve steady-state operating conditions.

This measure was developed to be applicable to the following program types: RF.

If applied to other program types, the measure savings should be verified.

DEFINITION OF EFFICIENT EQUIPMENT

To qualify the space heating boiler or furnace must have a new electrically or thermally activated shut off damper installed on either the exhaust flue or combustion air intake. Barometric dampers do not qualify. The damper actuation shall be interlocked with the firing controls.

DEFINITION OF BASELINE EQUIPMENT

The baseline boiler or furnace incorporates no shut off damper on the combustion air intake or flue exhaust.

DEEMED LIFETIME OF EFFICIENT EQUIPMENT

The measure life for the shut off damper is 15 years,⁷⁹³ or for the remaining lifetime of the heating equipment, whichever is less.

DEEMED MEASURE COST

Given the variability in cost associated with differences in system specifications and design, as well as choice of measure technology, actual installed costs should be used as available or based on program-specific qualification requirements. When unavailable, a deemed measure cost of \$1,500 shall be assumed.⁷⁹⁴

LOADSHAPE

N/A

COINCIDENCE FACTOR

N/A

Algorithm

CALCULATION OF SAVINGS

ELECTRIC ENERGY SAVINGS

N/A

SUMMER COINCIDENT PEAK DEMAND SAVINGS

N/A

⁷⁹³ State of Wisconsin Public Service Commission of Wisconsin Focus on Energy Evaluation Business Programs: Measure Life Study Final Report: August 25, 2009, Table 1-2. Recommended Measure Life by WISEerts Group Description, pg. 1-4.

⁷⁹⁴ CODES AND STANDARDS ENHANCEMENT INITIATIVE (CASE) PROCESS BOILERS, 2013 California Building Energy Efficiency Standards, California Utilities Statewide Codes and Standards Team, October 2011, pg. 22.

FOSSIL FUEL SAVINGS

$$\Delta\text{Therms} = \text{Ngi} * \text{SF} * \text{EFLH} / 100$$

Where:

Ngi = Boiler gas input size (kBtu/hr)

= Custom

SF = Savings factor

= 1%⁷⁹⁵

Note: The savings factor assumes the boiler or furnace is located in an unconditioned space. The savings factor can be higher for those units located within conditioned space.

EFLH = Default Equivalent Full Load Hours for heating in Existing Buildings are provided in section 4.4 HVAC End Use. When available, actual hours should be used.

100 = convert kBtu to therms

WATER IMPACT DESCRIPTIONS AND CALCULATION

N/A

DEEMED O&M COST ADJUSTMENT CALCULATION

A deemed, one-time Operations and Maintenance cost of \$150⁷⁹⁶ shall be included in cost-effectiveness calculations and occur in year 10 of the measure life to account for controller replacement.

MEASURE CODE: CI-HVC-SODP-V03-240101

REVIEW DEADLINE: 1/1/2029

⁷⁹⁵ Based on internet review of savings potential;

“Up to 4%”: Use of Automatic Vent Dampers for New and Existing Boilers and Furnaces, Energy Innovators Initiative Technical Fact Sheet, Office of Energy Efficiency, Canada, 2002

“Up to 1%”: Page 9, The Carbon Trust, “Steam and high temperature hot water boilers”, March 2012,

“1 - 2%”: Page 2, Sustainable Energy Authority of Ireland “Steam Systems Technical Guide”.

⁷⁹⁶ CODES AND STANDARDS ENHANCEMENT INITIATIVE (CASE) PROCESS BOILERS, 2013 California Building Energy Efficiency Standards, California Utilities Statewide Codes and Standards Team, October 2011, pg. 22.

4.4.24 Small Pipe Insulation

DESCRIPTION

This measure provides rebates for adding insulation to bare pipes with inner diameters of ½” and ¾”. Insulation must be at least one inch thick. Since new construction projects are required by code to have pipe insulation, this measure is only for retrofits of existing facilities. This covers bare straight pipe as well as all fittings.

Default savings are provided on a per linear foot basis. It is assumed that the majority of pipes less than one inch in commercial facilities are used for domestic hot water. However, this measure can cover hydronic heating systems as well as low and high pressure steam systems.

This measure was developed to be applicable to the following program types: RF.

If applied to other program types, the measure savings should be verified.

DEFINITION OF EFFICIENT EQUIPMENT

The efficient case is a ½” or ¾” diameter pipe with at least one inch of insulation. Insulation must be protected from damage which includes moisture, sunlight, equipment maintenance and wind. Outdoor pipes should have a weather protective jacket. Insulation must be continuous over straight pipe, elbows and tees.

DEFINITION OF BASELINE EQUIPMENT

The base case for savings estimates is a bare hot water or steam pipe with a fluid temperature of 105 degrees Fahrenheit or greater. Current new construction code requires insulation amounts similar to this measure, though this base case is commonly found in older existing buildings.

DEEMED LIFETIME OF EFFICIENT EQUIPMENT

The measure life is assumed to be 15 years.⁷⁹⁷

DEEMED MEASURE COST

The incremental measure cost for insulation is the full cost of adding insulation to the pipe. Actual installation costs should be used for the measure cost. For planning purposes, the following costs can be used to estimate the full cost of materials and labor.⁷⁹⁸

Insulation Thickness	¾” pipe	½” pipe
1”	\$4.45	\$4.15

LOADSHAPE

N/A

COINCIDENCE FACTOR

N/A

⁷⁹⁷ Measure Life Report, Residential and Commercial/Industrial Lighting and HVAC Measures, GDS Associates, June 2007.

⁷⁹⁸ A market survey was performed to determine these costs.

Algorithm

CALCULATION OF ENERGY SAVINGS

ELECTRIC ENERGY SAVINGS

N/A

SUMMER COINCIDENT PEAK DEMAND SAVINGS

N/A

FOSSIL FUEL SAVINGS

$$\begin{aligned} \Delta\text{Therms per foot}^{799} &= [((Q_{\text{base}} - Q_{\text{eff}}) * \text{EFLH}) / (100,000 * \eta_{\text{Boiler}})] * \text{TRF} \\ &= [\text{Modeled or provided by tables below}] * \text{TRF} \\ \Delta\text{Therms} &= (L_{\text{sp}} + L_{\text{oc,i}}) * \Delta\text{therms per foot} \end{aligned}$$

Where:

EFLH = Equivalent Full Load Hours for Heating
 = Actual or defaults by building type in Existing Buildings provided in Section 4.4, HVAC end use

For year round recirculation or domestic hot water:
 = 8,766

For heating season recirculation, hours with the outside air temperature below 55°F:

Zone	Hours
Zone 1 (Rockford)	5,039
Zone 2 (Chicago)	4,963
Zone 3 (Springfield)	4,495
Zone 4 (Belleville/	4,021
Zone 5 (Marion)	4,150

Q_{base} = Heat Loss from Bare Pipe (Btu/hr/ft)
 = Calculated where possible using 3E Plusv4.0 software. For defaults see table below

Q_{eff} = Heat Loss from Insulated Pipe (Btu/hr/ft)
 = Calculated where possible using 3E Plusv4.0 software. For defaults see table below

100,000 = conversion factor (1 therm = 100,000 Btu)

η_{Boiler} = Efficiency of the boiler being used to generate the hot water or steam in the pipe
 = 81.9% for water boilers⁸⁰⁰
 = 80.7% for steam boilers, except multifamily low-pressure⁸⁰¹

⁷⁹⁹This value comes from the reference table “Savings Summary by Building Type and System Type.” The formula and the input tables in this section document assumptions used in calculation spreadsheet “Pipe Insulation Savings 2013-11-12.xlsx”.

⁸⁰⁰ Average efficiencies of units from the California Energy Commission (CEC).

⁸⁰¹ Ibid.

= 64.8% for multifamily low-pressure steam boilers.⁸⁰²

TRF = Thermal Regain Factor for pipe location and use, see table below. The Custom TRF option may be used on any pipe location, including pipe locations with deemed TRFs specifically listed in the table below, if supporting justification and calculations for the Custom TRF are provided.

May vary seasonally such as: $TRF[summer] * \text{summer hours} + TRF[winter] * \text{winter hours}$ where TRF values reflecting summer and winter conditions are apportioned by the hours for those conditions. TRF may also be adjusted by building specific balance point temperature (BPT) and operating hours above and below that BPT.⁸⁰³

Pipe Location	Assumed Regain	TRF, Thermal Regain Factor
Outdoor	0%	1.0
Indoor, conditioned space during the heating season, 55°F BPT	85%	0.15
Indoor, conditioned space, not during the heating season, 55°F BPT	0%	1.0
Indoor, conditioned, annual use (e.g. hot water or process loads), 55°F BPT	45%	0.55
Indoor, semi- conditioned, (unconditioned space, with heat transfer to conditioned space. E.g., boiler room, ceiling plenum, basement, crawlspace, wall), during the heating season, 55°F BPT	30%	0.70
Indoor, semi-conditioned, not during the heating season, 55°F BPT	0%	1.0
Indoor, semi-conditioned, annual use, 55°F BPT	16%	0.84
Indoor, unconditioned spaces, (no heat transfer to conditioned space)	0%	1.0
Location not specified - Commercial	23%	0.77
Location not specified – Industrial	16%	0.84
Custom	Custom	1 – assumed regain

L_{sp} = Length of straight pipe to be insulated (linear foot)

$L_{oc,i}$ = Total equivalent length of (elbows and tees) of pipe to be insulated. Use table below to determine equivalent lengths.

Nominal Pipe Diameter	Equivalent Length (ft)	
	90 Degree Elbow	Straight Tee
1/2"	0.04	0.03
3/4"	0.06	0.05

⁸⁰² Katrakis, J. and T.S. Zawacki. "Field-Measured Seasonal Efficiency of Intermediate-sized Low-Pressure Steam Boilers". ASHRAE V99, pt. 2, 1993.

⁸⁰³ Zimmerman, Cliff, Franklin Energy, "Thermal Regain Factor_4-30-14.docx", 2014. Based on climate zone 2. Note 'Location not specified – Commercial' assumes semi-conditioned spaces with 50% pipes providing space heating and 50% providing DHW. 'Location not specified – Commercial' assumes semi-conditioned annual usage.

The table below shows the deemed therm savings by building type and region on a per linear foot basis for both ½” and ¾” copper pipe.

The following table provides deemed values for 1/2" copper pipe, temperatures are assumed by category below, and insulation is assumed to be one inch fiberglass.

Piping Use	Building Type	Annual Therms Saved / Linear Foot				
		Zone 1 (Rockford)	Zone 2 (Chicago)	Zone 3 (Springfield)	Zone 4 (Belleville)	Zone 5 (Marion)
Space Heating - Non-recirculating	Assembly	0.117	0.120	0.107	0.071	0.109
	Assisted Living	0.110	0.107	0.094	0.069	0.083
	College	0.100	0.093	0.083	0.046	0.055
	Convenience Store	0.097	0.089	0.079	0.057	0.064
	Elementary School	0.116	0.113	0.100	0.069	0.084
	Garage	0.064	0.063	0.056	0.044	0.049
	Grocery	0.105	0.105	0.092	0.057	0.068
	Healthcare Clinic	0.103	0.106	0.092	0.063	0.066
	High School	0.120	0.121	0.109	0.077	0.091
	Hospital - CAV no econ	0.115	0.119	0.101	0.087	0.099
	Hospital - CAV econ	0.117	0.121	0.103	0.089	0.101
	Hospital - VAV econ	0.048	0.045	0.034	0.020	0.022
	Hospital - FCU	0.087	0.099	0.080	0.094	0.127
	Hotel/Motel	0.115	0.112	0.101	0.069	0.084
	Hotel/Motel - Common	0.104	0.106	0.101	0.082	0.086
	Hotel/Motel - Guest	0.115	0.111	0.099	0.066	0.082
	Manufacturing Facility	0.068	0.066	0.061	0.037	0.041
	MF - High Rise	0.100	0.098	0.090	0.076	0.076
	MF - High Rise - Common	0.118	0.115	0.103	0.071	0.092
	MF - High Rise - Residential	0.096	0.096	0.087	0.075	0.073
	MF - Mid Rise	0.109	0.110	0.095	0.070	0.079
	Movie Theater	0.119	0.117	0.109	0.083	0.099
	Office - High Rise - CAV no econ	0.132	0.134	0.122	0.082	0.089
	Office - High Rise - CAV econ	0.136	0.139	0.128	0.088	0.097
	Office - High Rise - VAV econ	0.100	0.102	0.084	0.050	0.055
	Office - High Rise - FCU	0.073	0.072	0.062	0.033	0.035
	Office - Low Rise	0.093	0.093	0.074	0.045	0.052
	Office - Mid Rise	0.103	0.104	0.088	0.056	0.062
	Religious Building	0.105	0.098	0.094	0.069	0.079
	Restaurant	0.088	0.088	0.079	0.060	0.071
Retail - Department Store	0.091	0.083	0.078	0.051	0.058	
Retail - Strip Mall	0.087	0.081	0.071	0.049	0.053	
Warehouse	0.095	0.089	0.091	0.057	0.070	
Unknown	0.101	0.100	0.089	0.064	0.074	
Space Heating - recirculation heating season only	All buildings (Hours below 55°F)	0.329	0.324	0.293	0.262	0.271
Space Heating -	All buildings (All hours)	0.572	0.572	0.572	0.572	0.572

Piping Use	Building Type	Annual Therms Saved / Linear Foot				
		Zone 1 (Rockford)	Zone 2 (Chicago)	Zone 3 (Springfield)	Zone 4 (Belleville)	Zone 5 (Marion)
recirculation year round						
DHW	Recirculation loop	0.572	0.572	0.572	0.572	0.572
Process	Custom	Custom				

The following table provides deemed savings values for 3/4" copper pipe with temperatures assumed by category below, insulation is assumed to be one inch fiberglass.

Piping Use	Building Type	Annual Therms Saved / Linear Foot				
		Zone 1 (Rockford)	Zone 2 (Chicago)	Zone 3 (Springfield)	Zone 4 (Belleville)	Zone 5 (Marion)
Space Heating Non-recirculating	Assembly	0.142	0.145	0.129	0.086	0.132
	Assisted Living	0.133	0.130	0.115	0.084	0.101
	College	0.121	0.113	0.101	0.056	0.067
	Convenience Store	0.117	0.108	0.096	0.069	0.077
	Elementary School	0.141	0.137	0.121	0.084	0.102
	Garage	0.078	0.077	0.067	0.054	0.060
	Grocery	0.127	0.127	0.111	0.069	0.083
	Healthcare Clinic	0.125	0.128	0.112	0.076	0.081
	High School	0.146	0.147	0.132	0.094	0.110
	Hospital - CAV no econ	0.140	0.144	0.123	0.105	0.120
	Hospital - CAV econ	0.142	0.147	0.125	0.108	0.123
	Hospital - VAV econ	0.058	0.055	0.041	0.025	0.027
	Hospital - FCU	0.105	0.120	0.098	0.115	0.154
	Hotel/Motel	0.140	0.136	0.122	0.084	0.102
	Hotel/Motel - Common	0.127	0.129	0.123	0.100	0.105
	Hotel/Motel - Guest	0.139	0.135	0.120	0.081	0.099
	Manufacturing Facility	0.083	0.080	0.074	0.045	0.050
	MF - High Rise	0.121	0.119	0.109	0.093	0.093
	MF - High Rise - Common	0.144	0.140	0.125	0.086	0.111
	MF - High Rise - Residential	0.117	0.116	0.105	0.091	0.089
	MF - Mid Rise	0.132	0.134	0.115	0.085	0.096
	Movie Theater	0.144	0.142	0.133	0.101	0.120
	Office - High Rise - CAV no econ	0.160	0.162	0.148	0.099	0.108
	Office - High Rise - CAV econ	0.165	0.169	0.155	0.107	0.118
	Office - High Rise - VAV econ	0.121	0.123	0.102	0.060	0.067
	Office - High Rise - FCU	0.089	0.087	0.075	0.040	0.042
	Office - Low Rise	0.113	0.113	0.090	0.055	0.063
	Office - Mid Rise	0.126	0.126	0.106	0.068	0.075
	Religious Building	0.127	0.119	0.114	0.084	0.095
	Restaurant	0.107	0.107	0.096	0.073	0.086
	Retail - Department Store	0.110	0.101	0.095	0.062	0.071
	Retail - Strip Mall	0.106	0.098	0.086	0.059	0.064
Warehouse	0.115	0.108	0.111	0.069	0.085	
Unknown	0.123	0.122	0.108	0.078	0.090	
Space Heating - recirculation	All buildings (Hours below 55°F)	0.399	0.393	0.356	0.319	0.329

Piping Use	Building Type	Annual Therms Saved / Linear Foot				
		Zone 1 (Rockford)	Zone 2 (Chicago)	Zone 3 (Springfield)	Zone 4 (Belleville)	Zone 5 (Marion)
heating season only						
Space Heating - recirculation year round	All buildings (All hours)	0.694	0.694	0.694	0.694	0.694
DHW	Recirculation loop	0.694	0.694	0.694	0.694	0.694
Process	Custom	Custom				

WATER IMPACT DESCRIPTIONS AND CALCULATION

N/A

DEEMED O&M COST ADJUSTMENT CALCULATION

N/A

MEASURE CODE: CI-HVC-SPIN-V04-240101

REVIEW DEADLINE: 1/1/2027

4.4.25 Small Commercial Programmable Thermostat Adjustments – Retired 12/31/2019.

4.4.26 Variable Speed Drives for HVAC Supply and Return Fans

DESCRIPTION

This measure is applied to variable speed drives (VSD) which are installed on HVAC supply fans and return fans. The VSD will modulate the speed of the motor when it does not need to run at full load. Since the power of the motor is proportional to the cube of the speed for these types of applications, significant energy savings will result.

Note this measure should be used for evaluating control system modifications. If combined with the evaluation of a more efficient over a baseline fan, measure '4.4.53 HVAC Supply, Return and Exhaust Fans – Fan Energy Index' should be utilized. The FEPnew value from measure 4.4.53 should be used to replace the $\left(0.746 \times HP \times \frac{LF}{\eta_{motor}}\right)$ term in this measure.

This measure was developed to be applicable to the following program types: TOS, RF. If applied to other program types, the measure savings should be verified.

DEFINITION OF EFFICIENT EQUIPMENT

The VSD is applied to a motor which does not have a VSD. The application must have a variable load and installation is to include the necessary controls. Savings are based on application of VSDs to a range of baseline load conditions including no control, inlet guide vanes, outlet guide vanes and throttling valves.

DEFINITION OF BASELINE EQUIPMENT

The time of sale baseline is a new motor installed without a VSD or other methods of control. Retrofit baseline is an existing motor operating as is. Retrofit baselines may or may not include guide vanes, throttling valves or other methods of control. This information shall be collected from the customer.

Installations of new equipment with VSDs which are required by IECC, state energy code as adopted by the State of Illinois are not eligible for incentives. As code requirements and adoption can differ from municipality to municipality, the user should verify which version of code is applicable given these constraints.

Note, IECC 2021 became effective statewide on 1/1/2024. IECC 2018 is the requisite code for any projects with permitting dates spanning July 1, 2019 to 12/31/2023. Prior to July 1, 2019, IECC 2015 is the applicable code.

DEEMED LIFETIME OF EFFICIENT EQUIPMENT

The expected measure life for all VSDs is 15 years.⁸⁰⁴

DEEMED MEASURE COST

Customer provided costs will be used when available. Default measure costs are noted below for up to 75 hp motors.⁸⁰⁵ Custom costs must be gathered from the customer for motor sizes not listed below.

HP	Cost
5 HP	\$ 2,250
15 HP	\$ 3,318
25 HP	\$ 4,386
50 HP	\$ 6,573
75 HP	\$ 8,532

LOADSHAPE

Loadshape C39 - VFD - Supply fans <10 HP

Loadshape C40 - VFD - Return fans <10 HP

Loadshape C41 - VFD - Exhaust fans <10 HP

⁸⁰⁴ Efficiency Vermont TRM 10/26/11 for HVAC VSD motors.

⁸⁰⁵ NEEP Incremental Cost Study Phase Two Final Report dated January 13, 2013.

COINCIDENCE FACTOR

The demand savings factor (DSF) is already based upon coincident savings, and thus there is no additional coincidence factor for this characterization.

Algorithm

CALCULATION OF SAVINGS

ELECTRIC ENERGY SAVINGS⁸⁰⁶

Note this measure should be used for evaluating control system modifications. If combined with the evaluation of a more efficient over a baseline fan, measure ‘4.4.53 HVAC Supply, Return and Exhaust Fans – Fan Energy Index’ should be utilized. The FEP_{new} value from measure 4.4.53 should be used to replace the $\left(0.746 \times HP \times \frac{LF}{\eta_{motor}}\right)$ term in this measure.

$$kWh_{Base} = \left(0.746 \times HP \times \frac{LF}{\eta_{motor}}\right) \times RHRS_{Base} \times \sum_{0\%}^{100\%} (\%FF \times PLR_{Base})$$

$$kWh_{Retrofit} = \left(0.746 \times HP \times \frac{LF}{\eta_{motor}}\right) \times RHRS_{base} \times \sum_{0\%}^{100\%} (\%FF \times PLR_{Retrofit})$$

$$\Delta kWh_{fan} = kWh_{Base} - kWh_{Retrofit}$$

$$\Delta kWh_{total} = \Delta kWh_{fan} \times (1 + IE_{energy})$$

Where:

- kWh_{Base} = Baseline annual energy consumption (kWh/yr)
 - $kWh_{Retrofit}$ = Retrofit annual energy consumption (kWh/yr)
 - ΔkWh_{fan} = Fan-only annual energy savings
 - ΔkWh_{total} = Total project annual energy savings
 - 0.746 = Conversion factor for HP to kWh
 - HP = Nominal horsepower of controlled motor
 - LF = Load Factor; Motor Load at Fan Design CFM (Default = 65%)⁸⁰⁷
 - η_{motor} = Installed nominal/nameplate motor efficiency
- Default motor is a NEMA Premium Efficiency, ODP, 4-pole/1800 RPM fan motor

⁸⁰⁶ Methodology developed and tested in Del Balso, Ryan Joseph. “Investigation into the Reliability of Energy Efficiency/Demand Side Management Savings Estimates for Variable Frequency Drives in Commercial Applications”. A project report submitted to the Faculty of the Graduate School of the University of Colorado, 2013.

⁸⁰⁷ Lawrence Berkeley National Laboratory, and Resource Dynamics Corporation. (2008). “Improving Motor and Drive System Performance; A Sourcebook for Industry”. U.S. Department of Energy, Office of Energy Efficiency and Renewable Energy. Golden, CO: National Renewable Energy Laboratory.

NEMA Premium Efficiency Motors Default Efficiencies⁸⁰⁸

Size HP	Open Drip Proof (ODP)			Totally Enclosed Fan-Cooled (TEFC)		
	# of Poles			# of Poles		
	6	4	2	6	4	2
	Speed (RPM)			Speed (RPM)		
	1200	1800 Default	3600	1200	1800	3600
1	0.825	0.855	0.770	0.825	0.855	0.770
1.5	0.865	0.865	0.840	0.875	0.865	0.840
2	0.875	0.865	0.855	0.885	0.865	0.855
3	0.885	0.895	0.855	0.895	0.895	0.865
5	0.895	0.895	0.865	0.895	0.895	0.885
7.5	0.902	0.910	0.885	0.910	0.917	0.895
10	0.917	0.917	0.895	0.910	0.917	0.902
15	0.917	0.930	0.902	0.917	0.924	0.910
20	0.924	0.930	0.910	0.917	0.930	0.910
25	0.930	0.936	0.917	0.930	0.936	0.917
30	0.936	0.941	0.917	0.930	0.936	0.917
40	0.941	0.941	0.924	0.941	0.941	0.924
50	0.941	0.945	0.930	0.941	0.945	0.930
60	0.945	0.950	0.936	0.945	0.950	0.936
75	0.945	0.950	0.936	0.945	0.954	0.936
100	0.950	0.954	0.936	0.950	0.954	0.941
125	0.950	0.954	0.941	0.950	0.954	0.950
150	0.954	0.958	0.941	0.958	0.958	0.950
200	0.954	0.958	0.950	0.958	0.962	0.954
250	0.954	0.958	0.950	0.958	0.962	0.958
300	0.954	0.958	0.954	0.958	0.962	0.958
350	0.954	0.958	0.954	0.958	0.962	0.958
400	0.958	0.958	0.958	0.958	0.962	0.958
450	0.962	0.962	0.958	0.958	0.962	0.958
500	0.962	0.962	0.958	0.958	0.962	0.958

$RHRS_{Base}$ = Annual operating hours for fan motor based on building type

Default hours are provided for HVAC applications which vary by HVAC application and building type.⁸⁰⁹ When available (provided via Energy Management Software or metered), actual hours should be used.

Building Type	Total Fan Run Hours	Model Source
Assembly	7235	eQuest
Assisted Living	8760	eQuest
Auto Dealership	7451	OpenStudio
College	4836	OpenStudio
Convenience Store	7004	eQuest

⁸⁰⁸ Douglass, J. (2005). Induction Motor Efficiency Standards. Washington State University and the Northwest Energy Efficiency Alliance, Extension Energy Program, Olympia, WA, October 2005.

⁸⁰⁹ Hours per year are estimated using the eQuest or OpenStudio models as the total number of hours the fans are operating for heating, cooling and ventilation for each building type.

Building Type	Total Fan Run Hours	Model Source
Drug Store	7156	OpenStudio
Elementary School	3765	OpenStudio
Emergency Services	8760	OpenStudio
Garage	7357	eQuest
Grocery	8543	OpenStudio
Healthcare Clinic	4314	OpenStudio
High School	3460	OpenStudio
Hospital - VAV econ	4666	OpenStudio
Hospital - CAV econ	8021	OpenStudio
Hospital - CAV no econ	7924	OpenStudio
Hospital - FCU	4055	OpenStudio
Manufacturing Facility	8706	eQuest
MF - High Rise	8760	OpenStudio
MF - Mid Rise	8760	OpenStudio
Hotel/Motel - Guest	2409	OpenStudio
Hotel/Motel - Common	8683	OpenStudio
Movie Theater	7505	eQuest
Office - High Rise - VAV econ	2369	OpenStudio
Office - High Rise - CAV econ	2279	OpenStudio
Office - High Rise - CAV no econ	5303	OpenStudio
Office - High Rise - FCU	1648	OpenStudio
Office - Low Rise	6345	OpenStudio
Office - Mid Rise	3440	OpenStudio
Religious Building	7380	eQuest
Restaurant	7302	OpenStudio
Retail - Department Store	7155	OpenStudio
Retail - Strip Mall	6921	OpenStudio
Warehouse	6832	OpenStudio
Unknown	6241	n/a

%FF = Percentage of run-time spent within a given flow fraction range

Default Fan Duty Cycle Based on 2012 ASHRAE Handbook; HVAC Systems and Equipment, page 45.11, Figure 12.

Flow Fraction (% of design cfm)	Percent of Time at Flow Fraction
0% to 10%	0.0%
10% to 20%	1.0%
20% to 30%	5.5%
30% to 40%	15.5%
40% to 50%	22.0%
50% to 60%	25.0%
60% to 70%	19.0%
70% to 80%	8.5%
80% to 90%	3.0%
90% to 100%	0.5%

PLR_{Base} = Part load ratio for a given flow fraction range based on the baseline flow control type

$PLR_{Retrofit}$ = Part load ratio for a given flow fraction range based on the retrofit flow control type

Control Type	Flow Fraction									
	10%	20%	30%	40%	50%	60%	70%	80%	90%	100%
No Control or Bypass Damper	1.00	1.00	1.00	1.00	1.00	1.00	1.00	1.00	1.00	1.00
Discharge Dampers	0.46	0.55	0.63	0.70	0.77	0.83	0.88	0.93	0.97	1.00
Outlet Damper, BI & Airfoil Fans	0.53	0.53	0.57	0.64	0.72	0.80	0.89	0.96	1.02	1.05
Inlet Damper Box	0.56	0.60	0.62	0.64	0.66	0.69	0.74	0.81	0.92	1.07
Inlet Guide Vane, BI & Airfoil Fans	0.53	0.56	0.57	0.59	0.60	0.62	0.67	0.74	0.85	1.00
Inlet Vane Dampers	0.38	0.40	0.42	0.44	0.48	0.53	0.60	0.70	0.83	0.99
Outlet Damper, FC Fans	0.22	0.26	0.30	0.37	0.45	0.54	0.65	0.77	0.91	1.06
Eddy Current Drives	0.17	0.20	0.25	0.32	0.41	0.51	0.63	0.76	0.90	1.04
Inlet Guide Vane, FC Fans	0.21	0.22	0.23	0.26	0.31	0.39	0.49	0.63	0.81	1.04
VFD with duct static pressure controls	0.09	0.10	0.11	0.15	0.20	0.29	0.41	0.57	0.76	1.01
VFD with low/no duct static pressure	0.05	0.06	0.09	0.12	0.18	0.27	0.39	0.55	0.75	1.00

Provided below is the resultant values based upon the defaults provided above:

Control Type	$\sum_{0\%}^{100\%} (\%FF \times PLR_{Base})$
No Control or Bypass Damper	1.00
Discharge Dampers	0.80
Outlet Damper, BI & Airfoil Fans	0.78
Inlet Damper Box	0.69
Inlet Guide Vane, BI & Airfoil Fans	0.63
Inlet Vane Dampers	0.53
Outlet Damper, FC Fans	0.53
Eddy Current Drives	0.49
Inlet Guide Vane, FC Fans	0.39
VFD with duct static pressure controls	0.30
VFD with low/no duct static pressure	0.27

IE_{energy} = HVAC interactive effects factor for energy (default = 15.7%)

SUMMER COINCIDENT PEAK DEMAND SAVINGS

$$kW_{Base} = \left(0.746 \times HP \times \frac{LF}{\eta_{motor}} \right) \times PLR_{Base,FFpeak}$$

$$kW_{Retrofit} = \left(0.746 \times HP \times \frac{LF}{\eta_{motor}} \right) \times PLR_{Retrofit,FFpeak}$$

$$\Delta kW_{fan} = kW_{Base} - kW_{Retrofit}$$

$$\Delta kW_{total} = \Delta kW_{fan} \times (1 + IE_{demand})$$

Where:

kW_{Base} = Baseline summer coincident peak demand (kW)

$kW_{Retrofit}$	= Retrofit summer coincident peak demand (kW)
ΔkW_{fan}	= Fan-only summer coincident peak demand impact
ΔkW_{total}	= Total project summer coincident peak demand impact
$PLR_{Base,FFpeak}$	= The part load ratio for the average flow fraction between the peak daytime hours during the weekday peak time period based on the baseline flow control type (default average flow fraction during peak period = 90%)
$PLR_{Retrofit,FFpeak}$	= The part load ratio for the average flow fraction between the peak daytime hours during the weekday peak time period based on the retrofit flow control type (default average flow fraction during peak period = 90%)
IE_{demand}	= HVAC interactive effects factor for summer coincident peak demand (default = 15.7%)

FOSSIL FUEL IMPACT DESCRIPTIONS AND CALCULATION

There are no expected fossil fuel impacts for this measure.

WATER IMPACT DESCRIPTIONS AND CALCULATION

N/A

DEEMED O&M COST ADJUSTMENT CALCULATION

N/A

MEASURE CODE: CI-HVC-VSDF-V10-250101

REVIEW DEADLINE: 1/1/2026

4.4.27 Energy Recovery Ventilator

DESCRIPTION

This measure includes the addition of energy recovery equipment on existing or new unitary equipment, where energy recovery is not required by the IECC 2012/2015/2018/2021. This measure analyzes the heating and cooling savings potential from recovering energy from exhaust or relief building air. This measure assumes that during unoccupied hours of the building no exhaust or relief air is available for energy recovery.

This measure was developed to be applicable to the following program types: TOS, NC, RF.

If applied to other program types, the measure savings should be verified.

DEFINITION OF EFFICIENT EQUIPMENT

Efficient equipment is unitary equipment that incorporates energy recovery not required by the IECC 2012/2015/2018/2021.

DEFINITION OF BASELINE EQUIPMENT

The baseline is unitary equipment not required by IECC 2012/2015/2018/2021 to incorporate energy recovery.

Note, IECC 2021 became effective statewide on 1/1/2024. IECC 2018 is the requisite code for any projects with permitting dates spanning July 1, 2019 to 12/31/2023. Prior to July 1, 2019, IECC 2015 is the applicable code. As code requirements and adoption can differ from municipality to municipality, the user should verify which version of code is applicable given these constraints.

DEEMED LIFETIME OF EFFICIENT EQUIPMENT

The measure life for the domestic energy recovery equipment is 15 years.⁸¹⁰

DEEMED MEASURE COST

The incremental cost for this measure assumes cost of cabinet and controls incorporated into packaged and built up air handler units. Additionally, it assumes a 1 to 1 ratio of fresh and exhausted air.

Energy Recovery Equipment Type	Incremental Cost \$/CFM ⁸¹¹
Plate Heat Exchanger	\$3.75
Rotary Wheel	\$3.75
Heat Pipe	\$3.75

DEEMED O&M COST ADJUSTMENTS

There are no expected O&M savings associated with this measure.

LOADSHAPE

N/A

COINCIDENCE FACTOR

N/A

⁸¹⁰ Assumed service life limited by controls - "Demand Control Ventilation Using CO₂ Sensors", pg. 19, by US Department of Energy Efficiency and Renewable Energy.

⁸¹¹ "National Cost-Effectiveness of ASHRAE Standard 90.1-2010 Compared to ASHRAE Standard 90.1-2007", PNNL, November 2007 (page 4-16).

Algorithm

CALCULATION OF ENERGY SAVINGS ELECTRIC ENERGY SAVINGS

The electric energy savings calculation here represents the net electric energy savings from reduced cooling requirements after accounting for increased fan power caused by additional pressure drop from the ERV device. These savings do not account for heating energy savings in HVAC systems using heat pumps or electric resistance heat. This calculation does not apply to wheel-type devices with purge sections, or to sensible-only devices such as heat pipes.

- ΔkWh = (cfm) * Normalized Electric Energy Savings
- cfm = design supply air flow of energy recovery ventilator in cubic feet per minute
= rated energy recovery ventilator supply air flow * (1 – Exhaust Air Transfer Ratio)
- Exhaust Air Transfer Ratio = percentage of supply air made up of cross-leakage from exhaust air; value provided by vendor
= 0.05 (default)

Normalized Electric Energy Savings

= kWh/cfm savings value for the expected energy savings (net of fan energy penalty) as detailed in Table 1 – Electric Energy Savings Summary (kWh/cfm)

Table 1 – Electric Energy Savings Summary (kWh/cfm)⁸¹²

Building Type	Normalized Electricity Savings (kWh/OA cfm)				
	Zone 1 - Rockford	Zone 2 - Chicago	Zone 3 - Springfield	Zone 4 - Mt. Vernon/Belleville	Zone 5 - Marion
Enthalpy Wheel - 75% sensible and latent effectiveness					
Assembly	NA	NA	NA	0.107	0.229
Education	NA	NA	0.371	0.245	0.369
Grocery	NA	NA	0.239	0.523	0.630
Healthcare	1.551	1.594	2.508	2.999	3.077
Multifamily	2.178	2.566	3.781	4.746	5.029
Office	0.974	1.169	2.379	2.998	3.194
Retail	0.048	0.124	0.389	1.027	1.063
Enthalpy Plate - 50% sensible and latent effectiveness					
Assembly	NA	NA	NA	NA	NA
Education	NA	NA	NA	NA	0.035
Grocery	NA	NA	NA	0.002	0.102
Healthcare	0.923	0.963	1.548	1.841	1.908
Multifamily	0.627	0.908	1.450	2.341	2.509
Office	0.309	0.487	1.321	1.705	1.918
Retail	NA	NA	NA	0.398	0.435

SUMMER COINCIDENT PEAK DEMAND SAVINGS

- ΔkW = (cfm) * Normalized Electric Peak Demand Savings * CF
- = design supply air flow of energy recovery ventilator in cubic feet per minute

⁸¹² Energy savings modeled using IL TRM energy models with added energy recovery wheels or enthalpy plates. Energy recovery device specifications based on product data from the AHRI Certification Directory (<https://www.ahridirectory.org/Search/SearchHome?ReturnUrl=%2f>). See reference “ERV Effectiveness AHRI Directory Survey.”

= rated energy recovery ventilator supply air flow * (1 – Exhaust Air Transfer Ratio)

Exhaust Air Transfer Ratio = percentage of supply air made up of cross-leakage from exhaust air; value provided by vendor

= 0.05 (default)

CF = 1.0

Normalized Electric Peak Demand Savings

= kW/cfm savings value for the appropriate combination of building type, climate zone, and measure scenario per Table 2 – Electric Peak Demand Savings Summary (kW/cfm)

Table 2 – Electric Peak Demand Savings Summary (kW/cfm)⁸¹³

Building Type	Normalized Electric Demand Savings (kW/OA cfm)				
	Zone 1 - Rockford	Zone 2 - Chicago	Zone 3 - Springfield	Zone 4 - Mt. Vernon/Belleville	Zone 5 - Marion
Enthalpy Wheel - 75% sensible and latent efficiency					
Assembly	0.00127	0.00092	0.00111	0.00213	0.00209
Education	0.00159	0.00164	0.00282	0.00202	0.00308
Grocery	0.00115	0.00159	0.00152	0.00153	0.00187
Healthcare	0.00465	0.00433	0.00480	0.00443	0.00443
Multifamily	0.00210	0.00325	0.00298	0.00370	0.00381
Office	0.00538	0.00518	0.00527	0.00529	0.00589
Retail	0.00156	0.00195	0.00020	0.00217	0.00223
Enthalpy Plate - 50% sensible and latent efficiency					
Assembly	NA	NA	0.00024	0.00115	0.00113
Education	0.00114	0.00118	0.00201	0.00142	0.00218
Grocery	0.00059	0.00089	0.00083	0.00079	0.00102
Healthcare	0.00287	0.00284	0.00306	0.00292	0.00275
Multifamily	NA	0.00128	0.00111	0.00172	0.00167
Office	0.00351	0.00344	0.00344	0.00345	0.00384
Retail	0.00087	0.00123	0.00001	0.00119	0.00124

FOSSIL FUEL SAVINGS

Gas savings algorithm is derived from the following:

$$\Delta\text{Therms} = (\text{Design Heating Load} * \text{TE_ERV} * \text{EFLH} * \text{OccHours}/24) / (100,000 * \eta_{\text{Heat}})$$

Where:

$$\text{Design Heating Load} = (1.08 * \text{CFM} * \Delta\text{T})$$

1.08 = A constant for sensible heat equations (BTU/h/CFM.°F)

CFM = Cubic Feet per Minute of Energy Recovery Ventilator

$$\Delta\text{T} = \text{T_RA} - \text{T_DD}$$

T_RA = Temperature of the Return Air = 70°F or custom

⁸¹³ Demand savings modeled using IL TRM energy models with added energy recovery wheels or enthalpy plates. Energy recovery device specifications based on product data from the AHRI Certification Directory (<https://www.ahridirectory.org/Search/SearchHome?ReturnUrl=%2f>). Coincident demand measured according to TRM guidelines, though in 1-hour increments as established by the eQUEST simulation.

T_DD = Temperature on design day of outside air⁸¹⁴
 = (see Table below) or custom

Zone	Weather Station	T_DD, Temperature, °F
1	Greater Rockford	-5.4
2	Chicago/O’Hare ARPT.	-1.0
3	Springfield/Capital	1.1
4	Scott AFB MidAmerica	7.2
5	Cape Girardeau Regional	10.1
Average	-	2.4

TE_ERV = Thermal Effectiveness of Energy Recovery Equipment⁸¹⁵
 = (see Table below) or custom

Heat Recovery Equipment Type	TE_ERV (%)
Fixed Plate	0.65
Rotary Equipment	0.68
Heat Pipe	0.55

EFLH = Equivalent Full Load Hours for heating in Existing Buildings or New Construction are provided in section 4.4 HVAC End Use

OccHours = Average Hours per day facility is occupied
 = custom or use Modeling Inputs in eQuest models:

Building Type	Weekday	Saturday	Sunday	Holiday	Annual Operating Hours	OccHours
Assembly/Convention Center	10am-9pm	10am-9pm	10am-9pm	closed	3905	10.7
Assisted Living	24/7	24/7	24/7	24/7	8760	24.0
College	8am-9pm	closed	closed	closed	3263	8.9
Convenience Store	7am-10pm	9am-9pm	10am-5pm	10am-5pm	4823	13.2
Elementary School	8am-4pm (20% in summer)	closed	closed	closed	1606	4.4
Garage	7am-5pm	8am-12pm	closed	closed	3342	9.1
Grocery	7am-9pm	7am-9pm	9am-8pm	closed	4814	13.2
Healthcare Clinic	7am-7pm	9am-5pm	closed	closed	3428	9.4
High School	8am-4pm (20% in summer)	closed	closed	closed	1606	4.4
Hospital	24/7	24/7	24/7	24/7	8760	24.0
Motel	24/7	24/7	24/7	24/7	8760	24.0
Manufacturing Facility (Light Industry)	Mfg: 6am-10pm, Office: 8am-5pm	Mfg: 6am-10pm, Office: closed	closed	closed	4848	13.3
Multi-Family Mid-Rise	24/7; Reduced occupancy 7am - 5pm	24/7; Reduced occupancy 9am - 3pm	24/7; Reduced occupancy 9am - 3pm	24/7; Reduced occupancy 9am - 3pm	7038	19.3

⁸¹⁴Weather Station Data, 99.6% Heating DB - 2021 Fundamentals, ASHRAE Handbook. The following weather stations were referenced: Climate Zone 1: Chicago Rockford Int’l, Climate Zone 2: Chicago O’Hare Int’l, Climate Zone 3: Abraham Lincoln Capital, Climate Zone 4: Scott AFB, Climate Zone 5: Cape Girardeau Regional.

⁸¹⁵Energy Recovery Fact Sheet - Center Point Energy, MN

Building Type	Weekday	Saturday	Sunday	Holiday	Annual Operating Hours	OccHours
Multi-Family High-Rise	24/7; Reduced occupancy 7am - 5pm	24/7; Reduced occupancy 9am - 3pm	24/7; Reduced occupancy 9am - 3pm	24/7; Reduced occupancy 9am - 3pm	7038	19.3
Movie Theater	10am-Midnight	10am-Midnight	10am-Midnight	10am-Midnight	5110	14.0
Office - Low-rise	8am-5pm	closed	closed	closed	2259	6.2
Office - Mid-rise	8am-5pm	20% 8am-noon	closed	closed	2301	6.3
Office - High-rise	8am-5pm	20% 8am-noon	closed	closed	2301	6.3
Religious Building	Office: 8am-5pm, other: closed	closed	8am-1pm	closed	260	0.7
Restaurant	7am-8pm	7am-8pm	7am-8pm	closed	4615	12.6
Retail - Department Store	9am-9pm	9am-9pm	10am-5pm	10am-5pm	4070	11.1
Retail - Strip Mall	9am-9pm	9am-9pm	10am-5pm	10am-5pm	4070	11.1
Warehouse (Conditioned Storage)	7am-7pm	7am-7pm (reduced occupancy)	closed	closed	3324	9.1

η_{Heat} = Efficiency of heating system
 = Actual

WATER IMPACT DESCRIPTIONS AND CALCULATION

N/A

DEEMED O&M COST ADJUSTMENT CALCULATION

N/A

MEASURE CODE: CI-HVC-ERVE-V07-250101

REVIEW DEADLINE: 1/1/2026

4.4.28 Stack Economizer for Boilers Serving HVAC Loads

MEASURE DESCRIPTION

Stack economizers are designed to recover heat from hot boiler flue gasses. Recovered heat is used to preheat boiler feed water. This measure describes the retrofit of HVAC boilers with stack economizers. HVAC boilers are defined as those used for space heating applications. There is another, similar measure for boilers that serve process loads.

This measure was developed to be applicable to the following program types: NC, TOS, RF.

If applied to other program types, the measure savings should be verified.

DEFINITION OF EFFICIENT EQUIPMENT

To qualify the economizer must be installed on a boiler exhaust stack. Heat captured by the economizer is to be used to pre-heat boiler feed water.

DEFINITION OF BASELINE EQUIPMENT

The baseline boiler does not have an economizer installed.

DEEMED LIFETIME OF EFFICIENT EQUIPMENT

The measure life is assumed to be the lower of the remaining useful life of the boiler or 15 years.⁸¹⁶

DEEMED MEASURE COST

The incremental and full measure cost for this measure is custom.

DEEMED O&M COST ADJUSTMENTS

The O&M cost for this measure is custom.

LOADSHAPE

N/A

COINCIDENCE FACTOR

N/A

Algorithm

CALCULATION OF ENERGY SAVINGS

ELECTRIC ENERGY SAVINGS

N/A

SUMMER COINCIDENT PEAK DEMAND SAVINGS

N/A

FOSSIL FUEL SAVINGS

$$\Delta\text{therms} = \text{SF} * \text{MBH}_{\text{In}} * \text{EFLH} / 100$$

Where:

SF = Savings factor
 = calculated custom as $(T_{\text{existing}} - T_{\text{eff}}) / 40^{\circ}\text{F} * \text{TRE}$ or when not possible a default value based on the table below

⁸¹⁶ PA Consulting, Focus on Energy Evaluation, Business Programs: Measure Life Study, August 25, 2009.

Where:

- T_{existing} = Existing Full Fire Boiler Flue Gas Temperature as it exits the Stack⁸¹⁷
 = 425°F (water, 81.9% eff) or custom
 = 480°F (steam, 80.7% eff) or custom
- T_{eff} = Efficient Full Fire Boiler Flue Gas Temperature as it exits the Stack
 = 338°F (conventional economizer – Water Boiler)⁸¹⁸ or custom
 = 365°F (conventional economizer – Steam Boiler)⁸¹⁹ or custom
 = 280°F (condensing economizer – Water Boiler)⁸²⁰ or custom
 = 308°F (condensing economizer – Steam Boiler)⁸²¹ or custom
- TRE = % efficiency increase for 40°F of stack temperature reduction
 = 1%,⁸²² or custom

Based on defaults provided above:

Boiler Type	SF ⁸²³	
	Conventional Economizer	Condensing Economizer
Hot Water Boiler	2.19% average SF or custom	3.63% average SF or custom
Steam Boiler	2.88% average SF or custom	4.31% average SF or custom

MBH_{In} = Rated boiler input capacity, in MBH

= Actual

EFLH = Equivalent Full Load Hours for heating are provided in Section 4.4 HVAC End Use

WATER IMPACT DESCRIPTIONS AND CALCULATION

N/A

⁸¹⁷ Cleaver Brooks. March 2012, Boiler Efficiency Guide, Pg. 7, Figure 1.

⁸¹⁸ The minimum stack temperature for a non-condensing economizer is 250°F from Department of Energy (DOE). January 2012, Steam Tip Sheet #26A, Consider Installing a Condensing Economizer. Advanced Manufacturing Office. Washington, DC: U.S. Department of Energy. The average temperature drop is assumed to be ½ way between the existing and efficient temperature minimum, (425°F + 250°F) / 2 = 338°F.

⁸¹⁹ The minimum stack temperature for a non-condensing economizer is 250°F from Department of Energy (DOE). January 2012, Steam Tip Sheet #26A, Consider Installing a Condensing Economizer. Advanced Manufacturing Office. Washington, DC: U.S. Department of Energy. The average temperature drop is assumed to be ½ way between the existing and efficient temperature minimum, (480°F + 250°F) / 2 = 365°F.

⁸²⁰ The minimum stack temperature for a condensing economizer is 250°F from Department of Energy (DOE). January 2012, Steam Tip Sheet #26A, Consider Installing a Condensing Economizer. Advanced Manufacturing Office. Washington, DC: U.S. Department of Energy. The average temperature drop is assumed to be ½ way between the existing and efficient temperature minimum, (425°F + 135°F) / 2 = 280°F.

⁸²¹ The minimum stack temperature for a condensing economizer is 250°F from Department of Energy (DOE). January 2012, Steam Tip Sheet #26A, Consider Installing a Condensing Economizer. Advanced Manufacturing Office. Washington, DC: U.S. Department of Energy. The average temperature drop is assumed to be ½ way between the existing and efficient temperature minimum, (480°F + 135°F) / 2 = 308°F.

⁸²² United States EPA, Climate Wise: Wise Rules for Industrial Efficiency, July 1998. The Wise Rules indicate savings range of 1-2% per 40°F reduction, so utilizing 1% is a conservative approach.

⁸²³ These average values should be utilized in absence of actual temperature data. An economizer with a zero temperature change between the existing and the efficient temperatures would not be installed, so these average values are conservative.

DEEMED O&M COST ADJUSTMENT CALCULATION

Depending on design, stack economizers may require routine maintenance for optimal performance. A custom calculation should be used as necessary.

MEASURE CODE: CI-HVC-BECO-V03-250101

REVIEW DEADLINE: 1/1/2028

4.4.29 Stack Economizer for Boilers Serving Process Loads

MEASURE DESCRIPTION

Stack economizers are designed to recover heat from hot boiler flue gasses. Recovered heat is used to preheat boiler feed water. This measure describes the retrofit of process boilers with stack economizers. Process boilers are defined as those used for industrial, manufacturing, or other non-HVAC applications. There is another, similar measure for boilers that serve HVAC loads.

This measure was developed to be applicable to the following program types: NC, TOS, RF.

If applied to other program types, the measure savings should be verified.

DEFINITION OF EFFICIENT EQUIPMENT

To qualify the economizer must be installed on a boiler exhaust stack. Heat captured by the economizer is to be used to pre-heat boiler feed water.

DEFINITION OF BASELINE EQUIPMENT

The baseline boiler does not have an economizer installed.

DEEMED LIFETIME OF EFFICIENT EQUIPMENT

The measure life is assumed to be the lower of the remaining useful life of the for the boiler or 15 years.⁸²⁴

DEEMED MEASURE COST

The incremental and full measure cost for this measure is custom.

DEEMED O&M COST ADJUSTMENTS

The O&M cost for this measure is custom.

LOADSHAPE

N/A

COINCIDENCE FACTOR

N/A

Algorithm

CALCULATION OF ENERGY SAVINGS

ELECTRIC ENERGY SAVINGS

N/A

SUMMER COINCIDENT PEAK DEMAND SAVINGS

N/A

FOSSIL FUEL SAVINGS

$$\Delta \text{therms} = \text{SF} * \text{MBH}_{\text{In}} * 8766 * \text{UF} / 100$$

Where:

$$\text{SF} = (\text{T}_{\text{existing}} - \text{T}_{\text{eff}}) / 40^{\circ}\text{F} * \text{TRE}$$

⁸²⁴ PA Consulting, Focus on Energy Evaluation, Business Programs: Measure Life Study, August 25, 2009.

= see default Savings Factor table below

- T_{existing} = Existing Full Fire Boiler Flue Gas Temperature as it exits the Stack⁸²⁵
 = 425°F (water, 81.9% eff per IL TRM) or custom
 = 480°F (steam, 80.7% eff per IL TRM) or custom
- T_{eff} = Efficient Full Fire Boiler Flue Gas Temperature as it exits the Stack
 = 338°F (conventional economizer – Water Boiler)⁸²⁶ or custom
 = 365°F (conventional economizer – Steam Boiler)⁸²⁷ or custom
 = 280°F (condensing economizer – Water Boiler)⁸²⁸ or custom
 = 308°F (condensing economizer – Water Boiler)⁸²⁹ or custom
- TRE = % efficiency increase for 40°F of stack temperature reduction
 = 1%,⁸³⁰ or custom

Based on defaults provided above:

Boiler Type	SF ⁸³¹	
	Conventional Economizer	Condensing Economizer
Hot Water Boiler	2.19% average SF or custom	3.63% average SF or custom
Steam Boiler	2.88% average SF or custom	4.31% average SF or custom

- MBH_{In} = Rated boiler input capacity, in MBH
 = Actual
- 8766 = Hours a year
- UF = Utilization Factor
 = 41.9%,⁸³² or custom

⁸²⁵ Cleaver Brooks. March 2012, Boiler Efficiency Guide, Pg. 7, Figure 1.

⁸²⁶ The minimum stack temperature for a non-condensing economizer is 250°F from Department of Energy (DOE). January 2012, Steam Tip Sheet #26A, Consider Installing a Condensing Economizer. Advanced Manufacturing Office. Washington, DC: U.S. Department of Energy. The average temperature drop is assumed to be ½ way between the existing and efficient temperature minimum, (425°F + 250°F) / 2 = 338°F.

⁸²⁷ The minimum stack temperature for a non-condensing economizer is 250°F from Department of Energy (DOE). January 2012, Steam Tip Sheet #26A, Consider Installing a Condensing Economizer. Advanced Manufacturing Office. Washington, DC: U.S. Department of Energy. The average temperature drop is assumed to be ½ way between the existing and efficient temperature minimum, (480°F + 250°F) / 2 = 365°F.

⁸²⁸ The minimum stack temperature for a condensing economizer is 250°F from Department of Energy (DOE). January 2012, Steam Tip Sheet #26A, Consider Installing a Condensing Economizer. Advanced Manufacturing Office. Washington, DC: U.S. Department of Energy. The average temperature drop is assumed to be ½ way between the existing and efficient temperature minimum, (425°F + 135°F) / 2 = 280°F.

⁸²⁹ The minimum stack temperature for a condensing economizer is 250°F from Department of Energy (DOE). January 2012, Steam Tip Sheet #26A, Consider Installing a Condensing Economizer. Advanced Manufacturing Office. Washington, DC: U.S. Department of Energy. The average temperature drop is assumed to be ½ way between the existing and efficient temperature minimum, (480°F + 135°F) / 2 = 308°F.

⁸³⁰ United States EPA, Climate Wise: Wise Rules for Industrial Efficiency, July 1998. The Wise Rules indicate savings range of 1-2% per 40°F reduction, so utilizing 1% is a conservative approach.

⁸³¹ These average values should be utilized in absence of actual temperature data. An economizer with a zero temperature change between the existing and the efficient temperatures would not be installed, so these average values are conservative.

⁸³² Work Paper – Tune up for Boilers serving Space Heating and Process Load by Resource Solutions Group, January 2012

WATER IMPACT DESCRIPTIONS AND CALCULATION

N/A

DEEMED O&M COST ADJUSTMENT CALCULATION

N/A

MEASURE CODE: CI-HVC-PECO-V03-250101

REVIEW DEADLINE: 1/1/2026

4.4.30 Notched V Belts for HVAC Systems

MEASURE DESCRIPTION

This measure is for replacement of smooth v-belts in non-residential package and split HVAC systems with notched v-belts or for installing new equipment with synchronous belts instead of smooth v-belts. Typically there is a v-belt between the motor and the supply air fan and/or return air fan in larger package and split HVAC systems (RTU).

In general there are two styles of grooved v-belts, notched and synchronous. The DOE defines each as follows;

Notched V-Belts - A notched belt has grooves or notches that run perpendicular to the belt's length, which reduces the bending resistance of the belt. Notched belts can use the same pulleys as cross-section standard V-belts. They run cooler, last longer, and are about 2% more efficient than standard V-belts.

Synchronous Belts - Synchronous belts (also called cogged, timing, positive-drive, or high-torque drive belts) are toothed and require the installation of mating grooved sprockets. These belts operate with a consistent efficiency of 98% and maintain their efficiency over a wide load range.

- Smooth v-belts are usually referred to in five basic groups:
- "L" belts are low end belts that are for small, fractional horsepower motors and these are not used in RTUs.
- "A" and "B" belts are the two types typically used in RTUs. The "A" belt is a ½ inch width by 5/16 inch thickness and the "B" belt is larger, 21/32 inch wide and 12/32 inch thick so it can carry more power. V-belts come in a wide variety of lengths where 20 to 100 inches is typical.
- "C" and "D" belts are primarily for industrial applications with high power transmission requirements.
- V-belts are provided by various vendors. The notched version of these belts typically have an "X" added to the designation. For this HVAC fans notched v-belt Replacement measure, only the "A" and "B" v-belts are considered. A typical "A" v-belt is replaced by a notched "AX" v-belt and a "B" is replaced by a "BX." In general, smooth v-belts have an efficiency of 90% to 98% while notched v-belts have an efficiency of 95% to 98%. Because notched v-belts are more flexible they work with smaller diameter pulleys and they have less resistance to bending. Lower bending resistance increases the power transmission efficiency, lowers the waste heat, and allows the belt to last longer than a smooth belt.

Three research papers^{833 834 835} show that the notched v-belt efficiency is 2% to 5% better than a typical smooth v-belt. A fourth paper by USDOE's Energy Efficiency and Renewable Energy⁸³⁶ group reviewed most of the earlier literature and recommended using a conservative 2% efficiency improvement for energy savings for calculations.

For this measure it is assumed that upgrading a standard smooth v-belt with a new notched v-belt will result in a fan energy reduction of 2%.

DEFINITION OF EFFICIENT EQUIPMENT

For the Notched V-Belt characterization to apply, the Efficient Equipment is HVAC RTUs that have notched v-belts installed on the supply and/or return air fans. This can be done as a retrofit, TOS, or NC project.

For the Synchronous Belt characterization to apply, the Efficient Equipment is HVAC RTUs that have synchronous belts installed on the supply and/or return air fans. This can be done as a TOS or NC project. Retrofit projects can also claim savings, but costs should be verified independently (typically the cost of installing synchronous belts as a retrofit is not economically viable).

⁸³³ "Gates Corporation Announces New EPDM Molded Notch V-Belts," The Gates Rubber Co., June 2010 (Assumed 3% efficiency improvement).

⁸³⁴ "Synchronous Belt Drives Offer Low Cost Energy Savings," Baldor. February 2009. (attached in Reference Documents).

⁸³⁵ "Energy Savings from Synchronous Belts," The Gates Rubber Co., February 2014. (Assumed 5% efficiency improvement).

⁸³⁶ "Motor System Tip Sheet #5, Replace V-Belts with Cogged or Synchronous Belt Drives," USDOE-EERE, September 2005. (Assumed 2% efficiency improvement).

DEFINITION OF BASELINE EQUIPMENT

The Baseline Equipment is HVAC RTUs that have smooth v-belts installed on the supply and/or return air fans (i.e., RTU does not already have a notched v-belt installed).

DEEMED LIFETIME OF EFFICIENT EQUIPMENT

A v-belt has a life based on fan run hours which varies by building type based primarily on occupancy schedule because the fans are required by code to operate continuously during occupied hours. The supply and return fans will also run a few hours during unoccupied hours for heating and cooling as needed. For the notched v-belt EUL calculation, the default hours in the following table are used for a variety of building types and HVAC applications.⁸³⁷

$$EUL = \text{Belt Life} / \text{Occupancy Hours per year}$$

Where:

$$\text{Belt Life} = 24,000 \text{ hours}^{838}$$

$$\text{Occupancy Hours per year} = \text{values from Table below}$$

The notched v-belt measure EUL is summarized by building type in the following table.

Notched v-belt Effective Useful Life (EUL)

Building Type	Total Fan Run Hours	EUL (Years)	Model Source
Assembly	7235	3.3	eQuest
Assisted Living	8760	2.7	eQuest
Auto Dealership	7451	3.2	OpenStudio
College	4836	5.0	OpenStudio
Convenience Store	7004	3.4	eQuest
Drug Store	7156	3.4	OpenStudio
Elementary School	3765	6.4	OpenStudio
Emergency Services	8760	2.7	OpenStudio
Garage	7357	3.3	eQuest
Grocery	8543	2.8	OpenStudio
Healthcare Clinic	4314	5.6	OpenStudio
High School	3460	6.9	OpenStudio
Hospital - VAV econ	4666	5.1	OpenStudio
Hospital - CAV econ	8021	3.0	OpenStudio
Hospital - CAV no econ	7924	3.0	OpenStudio
Hospital - FCU	4055	5.9	OpenStudio
Manufacturing Facility	8706	2.8	eQuest
MF - High Rise	8760	2.7	OpenStudio
MF - Mid Rise	8760	2.7	OpenStudio
Hotel/Motel - Guest	2409	10.0	OpenStudio
Hotel/Motel - Common	8683	2.8	OpenStudio
Movie Theater	7505	3.2	eQuest
Office - High Rise - VAV econ	2369	10.1	OpenStudio
Office - High Rise - CAV econ	2279	10.5	OpenStudio
Office - High Rise - CAV no econ	5303	4.5	OpenStudio

⁸³⁷ ComEd Trm June 1, 2010 page 139. The Office hours is based upon occupancy from the eQuest model developed for EFLH, since it was agreed the ComEd value was too low.

⁸³⁸ "DEER2014-EUL-table-update_2014-02-05.xlsx," Database for Energy Efficiency Resources (DEER), DEER2014 EUL Table. (attached in Reference Documents).

Building Type	Total Fan Run Hours	EUL (Years)	Model Source
Office - High Rise - FCU	1648	14.6	OpenStudio
Office - Low Rise	6345	3.8	OpenStudio
Office - Mid Rise	3440	7.0	OpenStudio
Religious Building	7380	3.3	eQuest
Restaurant	7302	3.3	OpenStudio
Retail - Department Store	7155	3.4	OpenStudio
Retail - Strip Mall	6921	3.5	OpenStudio
Warehouse	6832	3.5	OpenStudio
Unknown	6241	3.8	n/a

The lifetime of a synchronous belt system is the same as the lifetime of the equipment it is installed on because it is a permanent upgrade, involving the installation of toothed pulleys. Typical HVAC RTU lifetime is 15 years, which applies to synchronous belts as well. This is not to suggest that the actual belt component has an equivalent lifetime because they do require replacement. However, their O&M cost savings (derived from not having to tension, etc.) are assumed to offset the replacement cost of the belt, resulting in a net cost of zero. As a result, neither a separate lifetime nor O&M savings are quantified for synchronous belts and lifetime can therefore be considered as the lifetime of the equipment they’re installed on because it would not be possible to install a traditional or notched belt on the synchronous pulleys.

DEEMED MEASURE COST

Costs of belts and pulleys are known to vary substantially based on belt length and pulley diameter. Two cost estimations are provided below; a fully deemed approach for applications such as an upstream program where limited information is known, and a semi-custom approach that is useful when more accurate cost estimates are desired.

Fully Deemed:

A review of the Grainger online pricing for “A,” “B,” “AX,” and “BX” v-belts⁸³⁹ revealed the incremental costs to upgrade to notched v-belts as summarized in the table below:

Notched V-belt Incremental Cost Summary

Smooth V-Belt Industry Number	Outside Length (Inches)	Dayton Smooth V-Belt*	Notched V-belt Industry Number	Dayton Notched v-belt*	Price Increase	% Increase
A30 (Item # 1A095)	32	\$10.38	AX30 (Item # 3GWU4)	\$14.64	\$4.26	41%
B29 (Item # 6L208)	32	\$14.38	BX29 (Item # 5TXL4)	\$20.80	\$6.42	45%

* Pricing based on Dayton Belts as found on Grainger Website 10/30/14

Note that the incremental cost for notched V-Belts assumes that the notched belt is purchased and installed instead of a smooth v-belt. There is no difference in the cost of installation, only the material.

Synchronous Belt Incremental Cost Summary

Smooth V-Belt Industry Number	Smooth belt system Price*	Synchronous Belt Industry Number	Synchronous System Price*	Price Difference
Belt A30 (Item # 1A095)	\$10.38	Belt 1DHL5 (Item # 322L050)	\$15.37	\$4.99

⁸³⁹ Grainger catalog on-line web-site for Dayton v-belt pricing.

Smooth V-Belt Industry Number	Smooth belt system Price*	Synchronous Belt Industry Number	Synchronous System Price*	Price Difference
Gearbelt pulley BK47 (Item #5UHD5)	\$47.98	Gearbelt sprocket GTR-36G-8M-12 (Item # 2UWH6)	\$113.91	\$65.93
* Costs based on Grainger pricing.				

Incremental cost for a NC or TOS project is \$136.85. This is the price of synchronous equipment (belt, two sprockets) subtract v-belt equipment (belt, two pulleys). Labor cost is assumed to be equal in the baseline and efficient cases.

Incremental cost for a RF project is \$380.49. This is the price of synchronous equipment and labor to install it⁸⁴⁰ (not including a trip charge), less the cost of the v-belt (but not the pulleys).

Semi-Custom⁸⁴¹

Use the following relationships along with NC, TOS and RF assumptions outlined above to estimate semi-custom costs.

Component	Type	Cost Function (per inch)	Inch Measurement
Standard V-Belt	A	\$0.28/in + \$0.96	Outside Length
Standard V-Belt	B	\$0.29/in + \$9.15	Outside Length
Standard Pulley	A, B, AX, BX	\$11.85/in - \$9.47	Outside Diameter
Notched Belt	AX	\$0.36/in + \$1.07	Outside Length
Notched Belt	BX	\$0.49/in + \$2.33	Outside Length
Synchronous Belt	1/2 inch	\$0.58/in + \$8.90	Pitch Length
Synchronous Belt	1 inch	\$0.26/in + \$5.67	Pitch Length
Synchronous Pulley	for use with 1/2 inch belt	\$27.20/in - \$21.19	Pitch Diameter
Synchronous Pulley	for use with 1 inch belt	\$25.04/in - \$27.23	Pitch Diameter

DEEMED O&M COST ADJUSTMENTS

N/A

LOADSHAPE

Loadshape C05 - Commercial Electric Heating and Cooling

COINCIDENCE FACTOR

N/A

Algorithm

CALCULATION OF ENERGY SAVINGS

ELECTRIC ENERGY SAVINGS

$$\Delta kWh = kW_{connected} * Hours * ESF$$

⁸⁴⁰ Assumed to be \$150 based on mechanical contractor estimate.

⁸⁴¹ Based on review and trend fitting cost data from Grainger online. See reference document “Notched V Belts costs.xlsx” for derivation.

Where:

$kW_{Connected}$ = kW of equipment is calculated using motor efficiency⁸⁴²
 = (HP * 0.746 kW/HP * Load Factor) / Motor Efficiency

Load Factor = Motors are assumed to have a load factor of 80% for calculating KW if actual values cannot be determined.⁸⁴³ Custom load factor may be applied if known.

Motor Efficiency = Actual motor efficiency shall be used to calculate KW. If not known a value from the motor efficiency reference tables below should be used.⁸⁴⁴ Default motor is a NEMA Premium Efficiency, ODP, 4-pole/1800 RPM fan motor.

Baseline Motor Efficiencies (EPACT)						
Size HP	Open Drip Proof (ODP)			Totally Enclosed Fan-Cooled (TEFC)		
	# of Poles					
	6	4	2	6	4	2
	Speed (RPM)					
	1200	1800	3600	1200	1800	3600
1/8	-	44.00%	-	-	-	-
1/6	57.50%	62.00%	-	-	-	-
1/4	68.00%	68.00%	-	68.00%	64.00%	-
1/3	70.00%	70.00%	72.00%	70.00%	68.00%	72.00%
1/2	78.50%	80.00%	68.00%	72.00%	74.00%	68.00%
3/4	77.00%	78.50%	74.00%	77.00%	75.50%	74.00%
1	80.00%	82.50%	75.50%	80.00%	82.50%	75.50%
1.5	84.00%	84.00%	82.50%	85.50%	84.00%	82.50%
2	85.50%	84.00%	84.00%	86.50%	84.00%	84.00%
3	86.50%	86.50%	84.00%	87.50%	87.50%	85.50%
5	87.50%	87.50%	85.50%	87.50%	87.50%	87.50%
7.5	88.50%	88.50%	87.50%	89.50%	89.50%	88.50%
10	90.20%	89.50%	88.50%	89.50%	89.50%	89.50%
15	90.20%	91.00%	89.50%	90.20%	91.00%	90.20%
20	91.00%	91.00%	90.20%	90.20%	91.00%	90.20%
25	91.70%	91.70%	91.00%	91.70%	92.40%	91.00%

Efficient Motor Efficiencies (NEMA Premium)						
Size HP	Open Drip Proof (ODP)			Totally Enclosed Fan-Cooled (TEFC)		
	# of Poles					
	2	4	6	2	4	6
	Speed (RPM)					
	1200	1800 (Default)	3600	1200	1800	3600
0.125 *	-	44.00%	-	-	-	-
1/6	57.50%	62.00%	-	-	-	-
1/4	68.00%	68.00%	-	68.00%	64.00%	-
1/3	70.00%	70.00%	72.00%	70.00%	68.00%	72.00%

⁸⁴² Note that kW_{Connected} may be determined using various methodologies. The examples provided use rated HP and assumed load factor. Other methodologies include rated voltage and full load current with assumed load factor, or actual measured voltage and current.

⁸⁴³ Com Ed TRM June 1, 2010.

⁸⁴⁴ Efficiency values for motors less than one HP taken from Baldor Electric Catalog 501, standard motor product catalog.

Efficient Motor Efficiencies (NEMA Premium)						
1/2	78.50%	80.00%	68.00%	72.00%	74.00%	68.00%
3/4	77.00%	78.50%	74.00%	77.00%	75.50%	74.00%
1	82.50%	85.50%	77.00%	82.50%	85.50%	77.00%
1.5	86.50%	86.50%	84.00%	87.50%	86.50%	84.00%
2	87.50%	86.50%	85.50%	88.50%	86.50%	85.50%
3	88.50%	89.50%	85.50%	89.50%	89.50%	86.50%
5	89.50%	89.50%	86.50%	89.50%	89.50%	88.50%
7.5	90.20%	91.00%	88.50%	91.00%	91.70%	89.50%
10	91.70%	91.70%	89.50%	91.00%	91.70%	90.20%
15	91.70%	93.00%	90.20%	91.70%	92.40%	91.00%
20	92.40%	93.00%	91.00%	91.70%	93.00%	91.00%
25	93.00%	93.60%	91.70%	93.00%	93.60%	91.70%

Hours = When available, actual hours should be used. If actual hours are not available, default hours are provided in table below for HVAC fan operation⁸⁴⁵, which varies by building type:

Building Type	Total Fan Run Hours	Model Source
Assembly	7235	eQuest
Assisted Living	8760	eQuest
Auto Dealership	7451	OpenStudio
College	4836	OpenStudio
Convenience Store	7004	eQuest
Drug Store	7156	OpenStudio
Elementary School	3765	OpenStudio
Emergency Services	8760	OpenStudio
Garage	7357	eQuest
Grocery	8543	OpenStudio
Healthcare Clinic	4314	OpenStudio
High School	3460	OpenStudio
Hospital - VAV econ	4666	OpenStudio
Hospital - CAV econ	8021	OpenStudio
Hospital - CAV no econ	7924	OpenStudio
Hospital - FCU	4055	OpenStudio
Manufacturing Facility	8706	eQuest
MF - High Rise	8760	OpenStudio
MF - Mid Rise	8760	OpenStudio
Hotel/Motel - Guest	2409	OpenStudio
Hotel/Motel - Common	8683	OpenStudio
Movie Theater	7505	eQuest
Office - High Rise - VAV econ	2369	OpenStudio
Office - High Rise - CAV econ	2279	OpenStudio
Office - High Rise - CAV no econ	5303	OpenStudio
Office - High Rise - FCU	1648	OpenStudio
Office - Low Rise	6345	OpenStudio

⁸⁴⁵ Hours per year are estimated using the eQuest models as the total number of hours the fans are operating for heating, cooling and ventilation for each building type.

Building Type	Total Fan Run Hours	Model Source
Office - Mid Rise	3440	OpenStudio
Religious Building	7380	eQuest
Restaurant	7302	OpenStudio
Retail - Department Store	7155	OpenStudio
Retail - Strip Mall	6921	OpenStudio
Warehouse	6832	OpenStudio
Unknown	6241	n/a

ESF = Energy Savings Factor, the ESF for notched v-belt Installation is assumed to be 2%
 = the ESF for notched Synchronous Belt Installation is assumed to be 3.1%⁸⁴⁶

For example, a notched v-belt installation in an low rise office building RTU with a 5 HP NEMA premium efficiency motor using the default hours of operation, motor load and 89.5% motor efficiency;

$$\begin{aligned} \Delta kWh &= kW_{\text{connected}} * \text{Hours} * \text{ESF} \\ &= ((\text{HP} * 0.746 \text{ kW/HP} * \text{Load Factor}) / \text{Motor Efficiency}) * \text{Hours} * \text{ESF} \\ &= ((5 \text{ HP} * 0.746 \text{ kW/HP} * 80\%) / 89.5\%) * 6288 * 2\% \\ &= 419 \text{ kWh Savings} \end{aligned}$$

SUMMER COINCIDENT PEAK DEMAND SAVINGS

$$\Delta kW = kW_{\text{connected}} * \text{ESF} * \text{CF}$$

Where:

$kW_{\text{Connected}}$ = kW of equipment is calculated using motor efficiency.
 = (HP * 0.746 kW/HP * Load Factor) / Motor Efficiency

CF_{SSP} = Summer System Peak Coincidence Factor for Commercial cooling (during system peak hour)
 = 91.3%⁸⁴⁷

CF_{PJM} = PJM Summer Peak Coincidence Factor for Commercial cooling (average during peak period)
 = 47.8%⁸⁴⁸

Variables as provided above

⁸⁴⁶ Based on information found in Advanced Manufacturing Office, US DOE, “Replace V-Belts with Notched or Synchronous Drives”, (US Department of Energy Motor Systems Tip Sheet #5, DOE/GO-102012-3740, November 2012). V-belt drives can have a peak efficiency of 95% and synchronous belts operate at 98%, therefore ESF is (1-95%/98%) = 3.1%.

⁸⁴⁷ Based on analysis of Itron eShape data for Missouri, calibrated to Illinois loads, supplied by Ameren. The AC load during the utility’s peak hour is divided by the maximum AC load during the year.

⁸⁴⁸Based on analysis of Itron eShape data for Missouri, calibrated to Illinois loads, supplied by Ameren. The average AC load over the PJM peak period (1-5pm, M-F, June through August) is divided by the maximum AC load during the year.

For example, an office building RTU with a 5 HP NEMA premium efficiency motor using the default motor load and 89.5% motor efficiency;

$$\begin{aligned}\Delta kW_{SSP} &= kW_{connected} * ESF * CF \\ &= ((HP * 0.746 \text{ kW/HP} * \text{Load Factor}) / \text{Motor Efficiency}) * ESF * CF \\ &= ((5 \text{ HP} * 0.746 \text{ kW/HP} * 80\%) / 89.5\%) * 2\% * 0.913 \\ &= 0.0609 \text{ kW Savings}\end{aligned}$$

FOSSIL FUEL SAVINGS

N/A

WATER IMPACT DESCRIPTIONS AND CALCULATION

N/A

DEEMED O&M COST ADJUSTMENT CALCULATION

N/A

MEASURE CODE: CI-HVC-NVBE-V06-210101

REVIEW DEADLINE: 1/1/2026

4.4.31 Small Business Furnace and Rooftop Unit Tune-Up

DESCRIPTION

This measure is for a fossil fuel Small Business furnace or Gas-Fired Rooftop Unit that provides space heating. The tune-up will improve furnace or gas-fired rooftop unit performance by inspecting, cleaning, and adjusting the furnace or rooftop unit and appurtenances for correct and efficient operation. Additional savings may be realized through a complete system tune-up.

This measure was developed to be applicable to the following program types: RF (small businesses).

If applied to other program types, the measure savings should be verified.

DEFINITION OF EFFICIENT EQUIPMENT

To qualify for this measure an approved technician must complete the tune-up requirements listed below:⁸⁴⁹

- Measure combustion efficiency using an electronic flue gas analyzer
- Check and clean blower assembly and components per manufacturer's recommendations
- Where applicable lubricate motor and inspect and replace fan belt, if required
- Inspect for gas leaks
- Clean burner per manufacturer's recommendations and adjust as needed
- Check ignition system and safety systems and clean and adjust as needed
- Check and clean heat exchanger per manufacturer's recommendations
- Inspect exhaust/flue for proper attachment and operation
- Inspect control box, wiring and controls for proper connections and performance
- Check air filter and clean or replace per manufacturer's recommendations
- Inspect duct work connected to furnace for leaks or blockages
- Measure temperature rise and adjust flow as needed
- Check for correct line and load volts/amps
- Check thermostat operation is per manufacturer's recommendations (if adjustments made, refer to 'Small Commercial Programmable Thermostat Adjustment' measure for savings estimate)
- Perform Carbon Monoxide test and adjust heating system until results are within standard industry acceptable limits

DEFINITION OF BASELINE EQUIPMENT

The baseline equipment is a furnace or a gas-fired rooftop unit assumed not to have had a tune-up in the past 3 years.

DEEMED LIFETIME OF EFFICIENT EQUIPMENT

The measure life for the tune up is 3 years.⁸⁵⁰

DEEMED MEASURE COST

The incremental cost for this measure should be the actual invoiced cost of the tune-up.

⁸⁴⁹ American Standard Heating & Air Conditioning, Maintenance for Indoor Units

⁸⁵⁰ Assumed consistent with other tune-up measures. For more detail, see: 4.4.1 Air Conditioner Tune-Up (3 years is given for "Clean Condenser Coils – Commercial" and "Clean Evaporator Coils". DEER2014 EUL Table.) and 4.4.2 Space Heating Boiler Tune-Up (Act on Energy Commercial Technical Reference Manual No. 2010-4, 9.2.2 Gas Boiler Tune-up.)

DEEMED O&M COST ADJUSTMENTS

There are no expected O&M savings associated with this measure.

LOADSHAPE

Loadshape C04 - Commercial Electric Heating

COINCIDENCE FACTOR

N/A

Algorithms

CALCULATION OF ENERGY SAVINGS

ELECTRIC ENERGY SAVINGS

$$\Delta\text{kWh} = \Delta\text{Therms} * F_e * 29.3$$

Where:

ΔTherms = as calculated below

F_e = Furnace or rooftop fan energy consumption as a percentage of annual fuel consumption
 = 7.7%⁸⁵¹

29.3 = kWh per therm

SUMMER COINCIDENT PEAK DEMAND SAVINGS

N/A

FOSSIL FUEL SAVINGS

$$\Delta\text{Therms} = (\text{Capacity} * \text{EFLH} * (((\text{Eff}_{\text{before}} + E_i) / \text{Eff}_{\text{before}}) - 1)) / 100,000$$

Where:

Capacity = Furnace gas input size (Btu/hr)
 = Actual

EFLH = Equivalent Full Load Hours for heating in Existing Buildings are provided in section 4.4 HVAC End Use

$\text{Eff}_{\text{before}}$ = Efficiency of the furnace before the tune-up
 = Actual

Note: Contractors should select a mid-level firing rate that appropriately represents the average building operating condition over the course of the heating season and take readings at a consistent firing rate for pre and post tune-up.

E_i = Efficiency Improvement of the furnace tune-up measure
 = Actual

100,000 = Converts Btu to therms

⁸⁵¹ F_e is estimated using TRM models for the three most popular building types for programmable thermostats: low-rise office (10.2%), sit-down restaurant (8.6%), and retail – strip mall (4.4%). 7.7% reflects the average F_e of the three building types. See “Fan Energy Factor Example Calculation 2021-06-23.xlsx” for reference.

For example, a 200 kBtu furnace in a Rockford low rise office records an efficiency prior to tune up of 82% AFUE and a 1.8% improvement in efficiency are tune up:

$$\begin{aligned}\Delta\text{therms} &= (200,000 * 1428 * (((0.82 + 0.018)/ 0.82) - 1)) / 100,000 \\ &= 62.3 \text{ therms}\end{aligned}$$

WATER IMPACT DESCRIPTIONS AND CALCULATION

N/A

DEEMED O&M COST ADJUSTMENT CALCULATION

N/A

O&M COST ADJUSTMENT CALCULATION

N/A

MEASURE CODE: CI-HVC-FTUN-V05-230101

REVIEW DEADLINE: 1/1/2028

4.4.32 Combined Heat and Power

DESCRIPTION

During 2021 and 2022, a TAC CHP Working Group held multiple discussions with a view to updating this measure. While some progress was made, including moving towards a more custom approach, a difference in policy interpretation relating to the appropriate calculation of gas savings, and the appropriate data for determining emission rates over the lifetime of the measure, has prevented reaching consensus. Discussions will continue in 2023 and if required a non-consensus exhibit will be completed and filed in order that the Commission can provide a ruling on the appropriate methodology. Until then, the existing version of this measure is maintained.

The Combined Heat and Power (CHP) measure can provide energy savings within the State of Illinois through the development and operation of CHP projects. This measure is applicable for Conventional or Topping Cycle CHP systems, as well as Waste Heat-to-Power (WHP) or Bottoming Cycle CHP systems. The measure will reduce the total Btu’s of energy required to meet the end use needs of the facility.

It is recognized that CHP system design and configuration may be complex, and as such the calculation of energy savings may not be reducible to the equations within this measure. In such cases a more comprehensive engineering and financial analysis may be developed that more accurately incorporates the attributes of complex CHP configurations such as variable-capacity systems, and partial combined-cycle CHP systems. Where noted, the use of values that are determined through an external engineering analysis may be substituted by agreement between the participant, the program administrator and independent evaluator. This substitution of values does not eliminate ex post evaluation risk (retroactive adjustments to savings claims) that exists when using custom inputs.

Due to the long planning horizon for CHP projects, CHP projects will use the project permit date to determine the version of the IL-TRM the implementation teams will follow. The purpose of this is to confirm the savings calculation methodologies for projects as early as possible due to the long planning horizon for the measure.

This measure was developed to be applicable to the following program types: Retrofit (RF), New Construction (NC). If applied to other program types, the measure savings should be verified.

DEFINITION OF EFFICIENT EQUIPMENT

Conventional or Topping Cycle CHP is defined as an integrated system that is located at or near the building or facility (on-site, on the customer side of the meter) that utilizes a prime mover (reciprocating engine, gas turbine, micro-turbine, fuel cell, boiler/steam turbine combination) for the purpose of generating electricity and useful thermal energy (such as steam, hot water, or chilled water) where the primary function of the facility where the CHP is located is not to generate electricity for use on the grid. An eligible system must demonstrate a minimum total system efficiency of 60% (HHV),⁸⁵² with at least 20% of the system’s total useful energy output in the form of useful thermal energy on an annual basis.

Measuring and Calculating Conventional CHP Total System Efficiency:

CHP efficiency is calculated using the following equation:

$$CHP_{Efficiency(HHV)} = \frac{\left[CHP_{thermal} \left(\frac{kBtu}{yr} \right) + E_{CHP} \left(\frac{kWh}{yr} \right) * 3.412 \left(\frac{kBtu}{kWh} \right) \right]}{F_{totalCHP} \left(\frac{kBtu}{yr} \right)}$$

Where:

⁸⁵² Higher Heating Value (HHV): refers to the heating value of the fuel and is defined as the total thermal energy available, including the heat of condensation of water vapors, resulting from complete combustion of the fuel versus the Lower Heating Value (LHV), which assumes the heat of condensation is not available.

$CHP_{thermal}$ = Useful annual thermal energy output from the CHP system, defined as the annual thermal energy output of the CHP system that is actually recovered and utilized in the facility/process.

E_{CHP} = Useful annual electricity output produced by the CHP system, defined as the annual electric energy output of the CHP system that is actually utilized to replace purchased electricity required to meet the requirements of the facility/process.

$F_{totalCHP}$ = Total annual fuel consumed by the CHP system

For further definition of the terms, please see “Calculation of Energy Savings” Section below.

Waste Heat-to-Power or Bottoming Cycle CHP is defined as an integrated system that is located at or near the building or facility (on-site, on the customer side of the meter) that does one of the following:

- Utilizes exhaust heat from an industrial/commercial process to generate electricity (except for exhaust heat from a facility whose primary purpose is the generation of electricity for use on the grid); or
- Utilizes the pressure drop in an industrial/commercial facility to generate electricity through a backpressure steam turbine where the facility normally uses a pressure reducing valve (PRV) to reduce the pressure in their facility; or
- Utilizes the pressure reduction in natural gas pipelines (located at natural gas compressor stations) before the gas is distributed through the pipeline to generate electricity, provided that the conversion of energy to electricity is achieved without using additional fossil fuels.

Since these types of systems utilize waste heat as their fuel, they do not have to meet any specific total system efficiency level (assuming they use no additional fossil fuel in their operation) If additional fuel is used onsite, it should be accounted for using the following methodology:

- Treat the portion of Waste-Heat-to-Power that does not require any additional fuel using the Waste-Heat-to-Power methodology outlined in this document.
- Treat the portion of Waste-Heat-to-Power that requires additional fuel (if natural gas) using the Conventional CHP methodology outlined in this document. If the additional fuel is not natural gas, custom carbon equivalency calculations would be needed – refer to section “Calculation of Energy Savings” for more details.
- Add the energy savings together.

These systems may export power to the grid.

DEFINITION OF BASELINE EQUIPMENT

Electric Baseline: The baseline facility would be a facility that purchases its electric power from the grid.

Heating Baseline (for CHP applications that displace onsite heat): The baseline equipment would be the boiler/furnace operating onsite, or a boiler/furnace meeting the baseline equipment defined in the High Efficiency Boiler (Section 4.4.10)/Furnace (Section 4.4.11) measures of this TRM.

Cooling Baseline (for CHP applications that displace onsite cooling demands): The baseline equipment would be the chiller (or chillers) operating onsite, or a chiller (or chillers) meeting the definition of baseline equipment defined in the Electric Chiller (Section 4.4.6) measure of this TRM.

Facilities that use biogas or waste gas: Facilities that use (but are not purchasing) biogas or waste gas that is not otherwise used, whether they are using biogas or waste gas only or a combination of biogas or waste gas and natural gas to meet their energy demands are also eligible for this measure. If additional fuel is purchased to power the CHP system, then the additional natural gas should be taken into account using the following methodology:

- Treat the portion of CHP system that does not require any additional fuel, or that requires additional fuel that would otherwise be wasted (e.g., flared), using the Waste-Heat-to-Power methodology outlined in this document.

- Treat the portion of CHP that requires additional fuel (if natural gas) using the Conventional CHP methodology outlined in this document. If the additional fuel is not natural gas, custom carbon equivalency calculations would be needed – refer to section “Calculation of Energy Savings” for more details.
- Add the energy savings together.

Consumption of any biogas or waste gas that would not otherwise being wasted (e.g., flared) will be accounted for in the overall net BTU savings calculations the same as for purchased natural gas.

DEEMED LIFETIME OF EFFICIENT EQUIPMENT

Measure life is a custom assumption, dependent on the technology selected and the system installation.

DEEMED MEASURE COST

Custom installation and equipment cost will be used. These costs should include the cost of the equipment and the cost of installing the equipment. Equipment costs include, but are not limited to: prime mover, heat recovery system(s), exhaust gas treatment system(s), controls, and any interconnection/electrical connection costs.

The installations costs include labor and material costs such as, but not limited to: labor costs, materials such as ductwork, piping, and wiring, project and construction management, engineering costs, commissioning costs, and other fees.

Measure costs will also include the present value of expected maintenance costs over the life of the CHP system.

LOADSHAPE

Use Custom Loadshape. The loadshape should be obtained from the actual CHP operation strategy, based on the On-Peak and Off-Peak Energy definitions specified in Table 3.3 of “Section 3.5 Electrical Loadshapes” of the TRM.

COINCIDENCE FACTOR

Custom coincidence factor will be used. Actual value based on the CHP operation strategy will be used.

Algorithm

CALCULATION OF ENERGY SAVINGS

i) Conventional or Topping Cycle CHP Systems:

Step 1: (Calculating Total Annual Source Fuel Savings in Btus)

The first step is to calculate the total annual source fuel savings associated with the CHP installation, in order to ensure the CHP project produces positive total annual source fuel savings (i.e., reduction in source Btus):

$$S_{\text{FuelCHP}} = \text{Annual fuel savings (Btu) associated with the use of a Conventional CHP system to generate the useful electricity output (kWh, converted to Btu) and useful thermal energy output (Btu) versus the use of the equivalent electricity generated and delivered by the local grid and the equivalent thermal energy provided by the onsite boiler/furnace.}$$

$$= (F_{\text{grid}} + F_{\text{thermalCHP}}) - F_{\text{total CHP}}$$

Where:

$$F_{\text{grid}} = \text{Annual fuel in Btu that would have been used to generate the useful electricity output of the CHP system if that useful electricity output was provided by the local utility grid.}$$

$$= E_{\text{CHP}} * H_{\text{grid}}$$

Where:

- E_{CHP} = Useful annual electricity output produced by the CHP system, defined as the annual electric energy output of the CHP system that is actually utilized to replace purchased electricity required to meet the requirements of the facility/process. ⁸⁵³
- $$= (CHP_{capacity} * Hours) - E_{Parasitic}$$
- $CHP_{capacity}$ = CHP nameplate capacity
= Custom input
- Hours = Annual operating hours of the system
= Custom input
- $E_{parasitic}$ = The electricity required to operate the CHP system that would otherwise not be required by the facility/process
= Custom input
- H_{grid} = Heat rate of the grid in Btu/kWh, based on the average fossil heat rate for the EPA eGRID subregion, adjusted to take into account T&D losses.

For systems operating less than 6,500 hrs per year:

Use the Non-baseload heat rate provided by EPA eGRID for RFC West region for ComEd territory (including independent providers connected to RFC West), and SERC Midwest region for Ameren territory (including independent providers connected to SERC Midwest).⁸⁵⁴ Also include any line losses.

For systems operating more than 6,500 hrs per year:

Use the All Fossil Average heat rate provided by EPA eGRID for RFC West region for ComEd territory (including independent providers connected to RFC West), and SERC Midwest region for Ameren territory (including independent providers connected to SERC Midwest). Also include any line losses.

$F_{thermalCHP}$ = Annual fuel in Btu that would have been used on-site by a boiler/furnace to provide the useful thermal energy output of the CHP system. ⁸⁵⁵

$$= CHP_{thermal} / Boiler_{eff} \text{ (or } CHP_{thermal} / Furnace_{eff} \text{)}$$

$CHP_{thermal}$ = Useful annual thermal energy output from the CHP system, defined as the annual thermal energy output of the CHP system that is actually recovered and utilized in the facility/process.

= Custom input

$Boiler_{eff} / Furnace_{eff}$ = Efficiency of the on-site Boiler/Furnace that is displaced by the CHP system or if unknown, the baseline equipment value stated in the High Efficiency Boiler (Section 4.4.10) measure or High Efficiency Furnace (Section 4.4.11) measure in this TRM.

= Custom input

⁸⁵³ For complex systems this value may be obtained from a CHP System design/financial analysis study.

⁸⁵⁴ These values are subject to regular updates so should be reviewed regularly to ensure the current assumptions are correct. Refer to the latest EPA eGRID data. Current values, based on eGrid 2018 are:

Non-Baseload RFC West: 10,024 Btu/kWh * (1 + Line Losses)

Non-Baseload SERC Midwest: 9,871 Btu/kWh * (1 + Line Losses)

All Fossil Average RFC West: 9,575 Btu/kWh * (1 + Line Losses)

All Fossil Average SERC Midwest: 10,369 Btu/kWh * (1 + Line Losses)

⁸⁵⁵ For complex systems this value may be obtained from a CHP System design/financial analysis study.

$F_{\text{total CHP}}$ = Total fuel in Btus consumed by the CHP system
 = Custom input

Step 2: (Savings Allocation to Program Administrators for Purposes of Assessing Compliance with Energy Savings Goals (Not for Use in Load Reduction Forecasting))

Savings claims are a function of the electric output of the CHP system (E_{CHP}), the used thermal output of the CHP system ($F_{\text{thermalCHP}}$), and the CHP system efficiency ($\text{CHP}_{\text{Eff}}(\text{HHV})$). The percentages of electric output and used thermal output that can be claimed also differ slightly depending on whether the project was included in both electric⁸⁵⁶ and gas⁸⁵⁷ Energy Efficiency Portfolio Standard (EEPS)⁸⁵⁸ efficiency programs, only an electric EEPS program or only a gas EEPS program. The tables below provide the specific percentages of electric and/or thermal output that can be claimed under each of those three scenarios. These percentages apply only to cases in which natural gas is the fuel used by the CHP system. Saving estimates for systems using other fuels should be calculated on a custom basis. If the waste heat recovered from the CHP system is offsetting electric equipment, such as an absorption chiller offsetting an electric chiller, then the net change in electricity consumption associated with the electric equipment should be added to the allocated electric savings.

1) For systems participating in both electric EEPS and gas EEPS programs:

CHP Annual System Efficiency (HHV)	Allocated Electric Savings	Allocated Gas Savings
60%	65% of E_{CHP} (kWh)	No gas savings
>60% to 65%	65% of E_{CHP} (kWh) + one percentage point increase for every one percentage point increase in CHP system efficiency (max 70% of E_{CHP} in kWh)	No gas Savings
>65%	70% of E_{chp} (kWh)	2.5% of F_{thermal} (Boiler Natural Gas offset by CHP thermal) for every one percentage point increase in CHP system efficiency above 65%.

Example: System with measured annual system efficiency (HHV) of 70%: Electric savings (kWh) = 70% of E_{CHP} measured over 12 months, and Gas savings (therms) = 12.5% of F_{thermal} measured over 12 months (70% - 65% = 5 X 2.5% = 12.5%).

2) For systems participating in only an electric EEPS program:

CHP Annual System Efficiency (HHV)	Allocated Electric Savings	Allocated Gas Savings
60%	65% of E_{CHP} (useful electric output of CHP system in kWh)	No gas Savings
Greater than 60%	65% + one percentage point increase for every one percentage point increase in CHP system efficiency (no max)	No gas Savings

Example: System with measured annual fuel use efficiency of 75%: Electric savings (kWh) = 65% + 15% = 80% of E_{CHP} measured over 12 months (15% = 1% for every 1% increase in system efficiency). No gas savings (therms).

3) For systems participating in only a gas EEPS program:

CHP Annual System Efficiency (HHV)	Allocated Electric Savings	Allocated Gas Savings
60% or greater	No electric savings	2.5% of $F_{thermal}$ (Boiler Natural Gas offset by CHP thermal) for every one percentage point increase in CHP system efficiency above 60%.

Example: System with measured annual system efficiency (HHV) of 70%: No Electric savings (kWh). Gas savings (therms) = 25% of $F_{thermal}$ measured over 12 months (70% - 60% = 10 X 2.5% = 25%).

Conventional or topping cycle CHP systems virtually always require an increase in the use of fuel on-site in order to produce electricity. Different jurisdictions and experts across the country have employed and/or put forward a variety of approaches to address how increased on-site fuel consumption should be reflected in the attribution of electric savings to CHP systems.⁸⁵⁹ The approach reflected in the tables above is generally consistent – for CHP systems consuming natural gas – with approaches recently put forward by the Southwest Energy Efficiency Project (SWEET) and Institute for Industrial Productivity (IIP) that determine reduced electric savings based on the equivalent amount of carbon dioxide generated from the increased fuel used.⁸⁶⁰

There are a variety of ways one could treat the potential for gas utilities to claim savings from CHP projects in their EEPS portfolios. For projects in which a natural gas EEPS program is involved, the tables above treat savings from CHP installations in two steps: (1) a fuel-switch from electricity to natural gas (i.e., using more natural gas to eliminate the need to generate as much electricity on the grid); and (2) possible increases in CHP efficiency above a “benchmark” level. When both electric EEPS and natural gas EEPS programs are involved in a project, the program administrator claims all the electricity savings associated with a fuel-switch up to a “benchmark” 65% efficient CHP system. All the savings associated with increasing CHP efficiencies above that benchmark level are allocated to natural gas (e.g., if the CHP efficiency is 75%, the natural gas savings associated with an increase in CHP efficiency from 65% to 75% are allocated to natural gas). That is consistent with the notion that CHP efficiency typically increases primarily by increasing the use of the thermal output of the system (increasing the displacement of baseline gas use). For projects that involve only a natural gas EEPS program, the “benchmark” above which the gas utility can claim savings is lowered to 60%.

ii) **Waste-Heat-to-Power CHP Systems :**

ELECTRIC ENERGY SAVINGS:

$$\Delta kWh = E_{CHP}$$

Where:

E_{CHP} = Useful annual electricity output produced by the CHP system, defined as the annual electric energy output of the CHP system that is actually utilized to replace purchased electricity required to meet the requirements of the facility/process.

= Custom input

SUMMER COINCIDENT PEAK DEMAND SAVINGS

$$\Delta kW = CF * CHP_{capacity}$$

Where:

- CF = Summer Coincidence factor. This factor should also consider any displaced chiller capacity.⁸⁶¹
- = Custom input
- CHP_{Capacity} = CHP nameplate capacity
- = Custom input

FOSSIL FUEL ENERGY SAVINGS:

$$\Delta\text{Therms} = F_{\text{thermalCHP}} \div 100,000$$

Where:

- F_{thermalCHP} = Net savings in annual purchased fuel in Btu, if any, that would have been used on-site by a boiler/furnace to provide some or all of the useful thermal energy output of the CHP system.⁸⁶²
- 100,000 = Conversion factor for Btu to therms

WATER IMPACT DESCRIPTIONS AND CALCULATION

N/A

DEEMED O&M COST ADJUSTMENT CALCULATION

Custom estimates of maintenance costs that will be incurred for the life of the measure will be used. Maintenance costs vary with type and size of the prime mover. These costs include, but are not limited to:

- Maintenance labor
- Engine parts and materials such as oil filters, air filters, spark plugs, gaskets, valves, piston rings, electronic components, etc. and consumables such as oil
- Minor and major overhauls

For screening purposes, the US EPA has published resource guides that provide average maintenance costs based on CHP technology and system size.⁸⁶³

COST-EFFECTIVENESS SCREENING AND LOAD REDUCTION FORECASTING

For the purposes of forecasting load reductions due to CHP projects, changes in site energy use at the customer’s meter – reduced consumption of utility provided electricity – adjusted for utility line losses (at-the-busbar savings), customer switching estimates, NTG, and any other adjustment factors deemed appropriate, should be used.

For the purposes of screening a CHP measure application for cost-effectiveness, changes in site energy use – reduced consumption of utility provided electricity and the net change in consumption of fuel – should be used. In general, the benefit and cost components used in evaluating the cost-effectiveness of a CHP project would include at least the following terms:

⁸⁶¹ If some or all of the existing electric chiller peak demand is no longer needed due to new waste heat powered chillers (e.g., absorption), the coincidence factor should be adjusted appropriately.

⁸⁶² In most cases, it is expected that waste-heat-to-power systems will not provide any new net useful thermal energy output, since the CHP system will be driven by thermal energy that was otherwise being wasted. If additional natural gas or other purchased energy is used onsite, it should be properly accounted for.

⁸⁶³ “EPA Combined Heat and Power Partnership Resources” Oct 07, 2014, in the document “Catalog of CHP Technologies”, US EPA, September 2017, pages 2-16,, 3-14, 4-14, 5-14, and 6-16.

MEASURE CODE: CI-HVC-CHAP-V07-230101

REVIEW DEADLINE: 1/1/2025

4.4.33 Commercial & Industrial Air Curtain

DESCRIPTION

This measure applies to buildings with exterior entryways that utilize overhead doors. All other air curtain applications, such as through sliding door entryways or conventional foot-traffic entryways, require custom analysis as air curtain designs must often accommodate other factors that may change their effectiveness.

The use of overhead doors within exterior entryways during the heating season leads to the exfiltration of warm air from the upper portion of the door opening and the infiltration of colder air from the lower portion of the door opening. This results in increase heating energy use to compensate for heat losses every time a door is opened. By reducing heat losses, air curtains can also enhance the physical comfort of employees or customers near the entryway as there will be reduced temperature fluctuations when the door is opened and closed. In addition, in some cases excess heating capacity may be installed in buildings to meet this larger heating load. The addition of air curtains to exterior entryways that currently utilize overhead doors will result in energy savings and enhanced personal comfort, and also possibly in reduced equipment sizing and corresponding costs.

The primary markets for this measure are commercial and industrial facilities with overhead doors in exterior entryways, including but not limited to the following building types: retail, manufacturing, and warehouse (non-refrigerated).

Limitations

- For use in conditioned spaces with an overhead door in an exterior entryway.
- This measure should only be applied to spaces in which the overhead door separates a conditioned space and an unconditioned space.
- Installation must follow manufacturer recommendations to attain proper air velocity, discharge angle down to the floor level, and unit position.
- Certain heating systems may not be a good fit for air curtains, such as locations with undersized heating capacity. In these cases, the installation of an air curtain may not effectively reduce heating system cycling given the inappropriately sized heating capacity.
- Buildings with slightly positive to slightly negative (~5 Pa to -10 Pa). For all other scenarios, custom analysis is recommended.
- Measure assumes that wind speeds at near ground level are less than or equal to 12 mph for 90% of the heating or cooling season. For areas with more extreme weather, custom analysis is necessary.
- Note: for cost effectiveness, it is recommended that minimum door open times should be approximately 15 hours per week.⁸⁶⁴

This measure was developed to be applicable to the following program types: NC, RF. If applied to other program types, the measure savings should be verified.

The following methodology is highly complex and requires significant data collection. It is hoped that simplifying steps can be made in future iterations based on continued metering and evaluation of installations. Also the data collected through implementing the measure in the way currently drafted will aid in simplifying efforts at a future date.

DEFINITION OF EFFICIENT EQUIPMENT

Overhead air curtains designed for commercial and industrial applications that have been tested and certified in accordance with ANSI/AMCA 220 and installed following manufacturer guidelines. Measure is for standard models without added heating.

⁸⁶⁴ Spentzas, Steve, et. al, “1009: Commercial and Industrial Air Curtains – Public Project Report,” Nicor Gas Emerging Technology Program (Oct 2014): 9.

DEFINITION OF BASELINE EQUIPMENT

No air curtain or other currently installed means to effectively reduce heat loss and air mixing during door openings, such as a vestibule or strip curtain.

DEEMED LIFETIME OF EFFICIENT EQUIPMENT

The expected measure life is assumed to be 15 years.⁸⁶⁵

DEEMED MEASURE COST

The incremental capital cost for overhead air curtains for exterior entryways are as follows, with an added average installation cost approximately equal to the capital cost.⁸⁶⁶

Door Size	Capital Cost
3.5’w x 7’h	\$1,500
6’w x 7’h	\$2,500
8’w x 8’h	\$3,600
10’w x 10’h	\$4,500
10’w x 12’h	\$5,400
12’w x 14’h	\$8,000
16’w x 16’h	\$13,300

LOADSHAPE

Heating Season: If electric heating, use Commercial Electric Heating Loadshape: C04. Otherwise, N/A

Cooling Season: Commercial Cooling Loadshape C03. Or, if applicable, use Commercial Electric Heating and Cooling Loadshape C05.

COINCIDENCE FACTOR

- CF_{SSP} = Summer System Peak Coincidence Factor for Commercial cooling (during system peak hour)
= 91.3%⁸⁶⁷
- CF_{PJM} = PJM Summer Peak Coincidence Factor for Commercial cooling (average during peak period)
= 47.8%⁸⁶⁸

Algorithm

CALCULATION OF ENERGY SAVINGS

The following formulas provide a methodology for estimating cooling load (kWh) and heating load (therm) savings associated with the installation of air curtains on exterior entryways such as a single door or loading bay. This algorithm is based on the assumption that therm savings are directly related to the difference in cooling or heating losses due to infiltration or exfiltration through an entryway before and after the installation of an AMCA certified

⁸⁶⁵ Navigant Consulting Inc, Measures and Assumptions for Demand Side Management (DSM) Planning: Appendix C: Substantiation Sheets, “Air Curtains – Single Door,” Ontario Energy Board, (April 2009): C-137. 2014 Database for Energy-Efficient Resources, EUL/RUL (Effective/Remaining Useful Life) Values, February 4, 2014.

⁸⁶⁶ Based on manufacturer interviews and air curtain specification sheets. Smaller doors are estimated based on interpolation of larger door costs.

⁸⁶⁷ Based on analysis of Itron eShape data for Missouri, calibrated to Illinois loads, supplied by Ameren. The AC load during the utility’s peak hour is divided by the maximum AC load during the year.

⁸⁶⁸Based on analysis of Itron eShape data for Missouri, calibrated to Illinois loads, supplied by Ameren. The average AC load over the PJM peak period (1-5pm, M-F, June through August) is divided by the maximum AC load during the year.

air curtain. Energy savings are assumed to be the result of a reduction of natural infiltration effects due to wind and thermal forces and follow the calculation methodology outlined by the ASHRAE Handbook.⁸⁶⁹ The calculation assumes that the air curtain is appropriately sized and commissioned to be effective in mitigating infiltration of winds of up to 12 mph for at a least 90% of the year (based on manufacturer literature and TMY3 wind speed ranges at near ground level for Illinois).⁸⁷⁰ Additionally, this measure assumes the HVAC systems are appropriately balanced such that the maximum pressure differential between indoor air and outdoor air is within the range of 5 Pa < ΔP < -10 Pa.⁸⁷¹ Custom analysis is necessary if building pressurization exceeds this range. However, while effectiveness decreases, some studies suggest that air curtains outperform vestibules and single door construction for negatively pressurized buildings with a ΔP of above -30 Pa.⁸⁷²

This algorithm allows either actual inputs or provides estimates if actual data is not available. All weather dependent values are derived from TMY3 data for the closest weather station to those locations defined elsewhere in the Illinois TRM (which are based on 30 year climate normals). If TMY3 weather station data was not available for the data used in the Illinois TRM, the next closest weather station was used. It is assumed that weather variations are negligible between the weather stations located within the same region. This approach was followed as the air curtain algorithm has a number of weather dependent variables, which are all calculated in relation to the heating season or cooling season as defined by the balance point temperature deemed appropriate for the facility. All weather dependent data is based on TMY3 data and is listed in tables by both climate zone and balance point temperature, which is then normalized to the Illinois TRM climate zoned HDD/CDD definitions unless otherwise noted.

ELECTRIC ENERGY SAVINGS

$$\Delta kWh_{cooling} = [(Q_{tbc} - Q_{tac}) / EER - (HP * 0.7457)] * t_{open} * CD$$

$$\Delta kWh_{HPheating} = [(Q_{tbc} - Q_{tac}) / HSPF - (HP * 0.7457)] * t_{open} * HD$$

$$\Delta kWh_{Gasheating} = - (HP * 0.7457) * t_{open} * HD$$

Where:

Q_{tbc} = rate of total heat transfer through the open entryway, before air curtain (kBtu/hr)

Q_{tac} = rate of total heat transfer through the open entryway, after air curtain (kBtu/hr)

(see calculation in ‘Heat Transfer Through Open Entryway with/without Air Curtain’ sections below)

EER = energy efficiency ratio of the cooling equipment (kBtu/kWh)

= Actual. If unknown, use the table C403.2.3(2) in IECC 2012 (or IECC 2021 if through new construction) or as deemed from table below⁸⁷³:

Space Cooling / Heating Source	Deemed Cooling EER	Deemed Cooling SEER
No Cooling	N/A	N/A
Unknown Cooling Source	11	13

⁸⁶⁹ ASHRAE, “Ventilation and Infiltration,” in 2013 ASHRAE Handbook – Fundamentals (2013): Ch 16.1 - 16.37.

⁸⁷⁰ National Solar Radiation Data Base – 1991 – 2005 Update: Typical Meteorological Year 3, NREL.

⁸⁷¹ Spentzas, Steve, et. al, “1009: Commercial and Industrial Air Curtains – Public Project Report,” Nicor Gas Emerging Technology Program (Oct 2014): 10.

Wang, Liangzhu, “Investigation of the Impact of Building Entrance Air Curtain on Whole Building Energy Use,” Air Movement and Control International, Inc. (2013). 4.

⁸⁷² Wang, Liangzhu, “Investigation of the Impact of Building Entrance Air Curtain on Whole Building Energy Use,” Air Movement and Control International, Inc. (2013). 4.

⁸⁷³ Simplified version of IECC 2012 as a conservative estimate of what is existing.

HP = Input power for air curtain (hp)

= Actual value. If actual value not available, use the following estimates based on manufacturer specs

Door Size	Fan HP
3.5'w x 7'h	0.5
6'w x 7'h	0.75
8'w x 8'h	1
10'w x 10'h	1.5
10'w x 12'h	4
12'w x 14'h	6
16'w x 16'h	12

0.7457 = unit conversion factor, brake horsepower to electric power (kW/HP)

t_{open} = average hours per day the door is open (hr/day)

= Actual or user defined estimated value.

CD = cooling days per year, total days in year above balance point temperature (day)

= use table below to select the best value for location:⁸⁷⁴

Climate Zone -Weather Station/City	CD (Balance Point Temperature)				
	45 °F	50 °F	55 °F	60 °F	65 °F
1 - Rockford AP / Rockford	194	168	148	124	97
2 - Chicago O'Hare AP / Chicago	194	173	153	127	95
3 - Springfield #2 / Springfield	214	194	174	148	114
4 - Belleville SIU RSCH / Belleville	258	229	208	174	138
5 - Carbondale Southern IL AP / Marion	222	201	181	158	130

HSPF = Heating System Performance Factor of heat pump equipment

= Actual. If unknown, use the table C403.2.3(2) in IECC 2012 (or IECC 2021 if through new construction)

Alternatively, as deemed from table below:

System Type	Cooling Capacity of Equipment	Age of Equipment	HSPF Estimate
Heat Pump ⁸⁷⁵	All	Before 2009	6.8

⁸⁷⁴ National Solar Radiation Data Base – 1991 – 2005 Update: Typical Meteorological Year 3, NREL.

Note that cooling days (CD) are calculated by first determining its value from the TMY3 data associated with the appropriate weather station as defined by and used elsewhere in the Illinois TRM. Using the TMY3 outdoor air dry bulb hourly data, the annual hours are totaled for every hour that the outdoor air dry bulb temperature is above a designated zero heat loss balance point temperature or base temperature for cooling. For commercial and industrial (C&I) buildings, a base temperature for heating of 55 °F is designated in the Illinois TRM, but building specific base temperatures are recommended for large C&I projects. Additionally, the TRM uses a 30-year normal data for degree-days while the CD calculation was based on TMY3 data; in order to account for this, calculations of CD were also normalized by the ratio of CDD to align the calculated values more closely with the TRM.

⁸⁷⁵ Minimum heating efficiency standards for heat pumps are sourced from the Code of Federal Standards for Small and Large Commercial Package Air Conditioning and Heating Equipment (Air Cooled), 10 CFR 431.97 with compliance dates of June 16,

System Type	Cooling Capacity of Equipment	Age of Equipment	HSPF Estimate
	< 65,000 Btu/h	2009 - 2017	7.7
		2017 on	8.2
	≥ 65,000 Btu/h and < 135,000 Btu/h	2010 on	11.3
	≥ 135,000 Btu/h and < 240,000 Btu/h	2010 on	10.9
	≥ 240,000 Btu/h and < 760,000 Btu/h	2010 on	10.9
Resistance	N/A	N/A	N/A

HD = heating days per year, total days in year above balance point temperature (day)
 = use table below to select an appropriate value:⁸⁷⁶

Climate Zone Weather Station/City	HD				
	45 °F	50 °F	55 °F	60 °F	65 °F
1 - Rockford AP / Rockford	142	160	183	204	228
2 - Chicago O'Hare AP / Chicago	150	166	192	219	253
3 - Springfield #2 / Springfield	125	142	167	194	230
4 - Belleville SIU RSCH / Belleville	101	115	134	156	180
5 - Carbondale Southern IL AP / Marion	103	123	148	174	205

Heat Transfer Through Open Entryway without Air Curtain (Cooling Season)

$$Q_{tbc} = 4.5 * CFM_{tot} * (h_{oc} - h_{ic}) / (1,000 \text{ Btu/kBtu})$$

Where:

4.5 = unit conversion factor with density of air: 60 min/hr * 0.075 lbm/ft3 (lb*min/(ft*hr))

CFM_{tot} = Total air flow through entryway (cfm), see calculation below

h_{oc} = average enthalpy of outside air during the cooling season (Btu/lb)

= use the below table to determine the approximate outdoor air enthalpy associated with an indoor temperature setpoint and climate zone.⁸⁷⁷

Climate Zone -Weather Station/City	h _{oc}		
	67 °F	72 °F	77 °F
1 - Rockford AP / Rockford	31.6	33.0	35.3
2 - Chicago O'Hare AP / Chicago	32.0	33.6	35.4
3 - Springfield #2 / Springfield	32.9	34.6	36.6

2008; January 1, 2010; January 1, 2017; and January 1, 2018. As the first federal appliance standards for heating efficiency for commercial heat pumps went into effect in June 2008, assuming efficiency standards equivalent to residential heat pumps prior to that date.

⁸⁷⁶ Note that Heating Days (HD) are calculated following the same approach outlined in the Cooling Days section.

⁸⁷⁷ Average enthalpies were estimated following ASHRAE guidelines for perfect gas relationships for dry air associated with hourly TMY3 data. Enthalpies were then averaged for all values associated with a dry-bulb outdoor air temperature that exceeded the indoor air temperature setpoint. Other enthalpy values may be interpolated for indoor air temperature setpoints not represented in the table. Note that while outdoor air enthalpies increase with higher temperature setpoints, the change in enthalpy from indoor to outdoor will decrease.

Climate Zone -Weather Station/City	h _{oc}		
	67 °F	72 °F	77 °F
4 - Belleville SIU RSCH / Belleville	33.5	35.0	36.4
5 - Carbondale Southern IL AP / Marion	34.6	36.2	37.7

h_{ic} = average enthalpy of indoor air, cooling season (Btu/lb)

= use the below table to determine the approximate indoor air enthalpy associated with an indoor temperature setpoint in indoor relative humidity.

Relative Humidity (%)	h _{ic}		
	67 °F	72 °F	77 °F
60	25.5	28.5	31.8
50	23.9	26.6	29.5
40	22.3	24.7	27.3

= an estimate 26.6 Btu/lb associated with the 72 °F and 50% indoor relative humidity case can be used as an approximation if no other data is available. For other indoor temperature setpoints and RH, enthalpies may be interpolated or a psychrometric chart may be referenced.

The total airflow through the entryway, CFM_{tot}, includes both infiltration due to wind as well as thermal forces, as follows:

$$CFM_{tot} = \sqrt{ (CFM_w)^2 + (CFM_t)^2 }$$

Where:

CFM_w = Infiltration due to the wind (cfm)

CFM_t = Infiltration due to thermal forces (cfm)

The infiltration due to the wind is calculated as follows:

$$CFM_w = (v_{wc} * C_{wc}) * C_v * A_d * (88 \text{ fpm/mph})$$

Where:

v_{wc} = average wind speed during the cooling season based on entryway orientation (mph)

= use the below table to for the wind speed effects based on climate zone and entryway orientation:⁸⁷⁸

Climate Zone -Weather Station /City	Entryway Orientation			
	N	E	S	W
1 - Rockford AP / Rockford	4.2	4.1	4.7	4.8
2 - Chicago O'Hare AP / Chicago	4.7	4.5	5.4	4.6
3 - Springfield #2 / Springfield	4.1	3.7	6.0	5.0
4 - Belleville SIU RSCH / Belleville	3.3	2.7	3.8	4.2
5 - Carbondale Southern IL AP / Marion	3.1	2.9	4.4	3.8

C_{wc} = wind speed correction factor due to wind direction in cooling season (%)

⁸⁷⁸ Average wind speeds are calculated based on the TMY3 wind speed data. Because this data is collected at an altitude of 33 ft, wind speed is approximated for a 5 ft level based on ASHRAE Handbook guidelines using the urban/suburban parameters for adjusting wind speed based on altitude (Layer thickness (ft) δ = 1200, Exponent a = 0.22). ASHRAE, "Airflow Around Buildings," in 2013 ASHRAE Handbook – Fundamentals (2013): p 24.3.

= because wind direction is not constant, a wind speed correction factor is used to adjust for the amount of time during the cooling season prevailing winds can be expected to impact the entryway. Use the following table to determine the correct wind speed correction factor for cooling applications.

Climate Zone -Weather Station/City	Entryway Orientation			
	N	E	S	W
1 - Rockford AP / Rockford	0.18	0.13	0.30	0.31
2 - Chicago O'Hare AP / Chicago	0.18	0.17	0.36	0.26
3 - Springfield #2 / Springfield	0.17	0.12	0.46	0.21
4 - Belleville SIU RSCH / Belleville	0.21	0.15	0.35	0.16
5 - Carbondale Southern IL AP / Marion	0.18	0.15	0.37	0.11

Note that correction factors do not add up to 1 (100%). This is attributed to periods of calm winds.

- C_v = effectiveness of openings,
= 0.3, assumes diagonal wind⁸⁷⁹
- A_d = area of the doorway (ft²)
= user defined

The infiltration due to thermal forces is calculated as follows:

$$CFM_t = A_d * C_{dc} * (60 \text{ sec/min}) * \sqrt{2 * g * H/2 * (T_{oc} - T_{ic}) / (459.7 + T_{oc})}$$

Where:

- C_{dc} = the discharge coefficient during the cooling season⁸⁸⁰
= $0.4 + 0.0025 * |T_{ic} - T_{oc}|$
= 0.42, Illinois average at indoor air temp of 72°F

Note, values for C_{dc} show little variation due to balance point temperature, indoor air temperature, and climate zone. As such, if estimating results, the Illinois average value may be used as a simplification.

- g = acceleration due to gravity
= 32.2 ft/sec²
- H = the height of the entryway (ft)
= user input
- T_{ic} = Average indoor air temperature during cooling season
= User input, can assume indoor cooling temperature set-point
- T_{oc} = Average outdoor temp during cooling season (°F)
= the average outdoor temperature is dependent on the CD period and zone. As such, the following table may be used for average outdoor temperature during the cooling period:⁸⁸¹

Climate Zone Weather Station/City	T_{oc}				
	62 °F	67 °F	72 °F	77 °F	82 °F
1 - Rockford AP / Rockford	72.9	76.0	79.2	82.5	85.5
2 - Chicago O'Hare AP / Chicago	72.9	76.0	79.4	82.8	85.5

⁸⁷⁹ ASHRAE, "Ventilation and Infiltration," in 2013 ASHRAE Handbook – Fundamentals (2013): p 16.13

⁸⁸⁰ ASHRAE, "Ventilation and Infiltration," in 2013 ASHRAE Handbook – Fundamentals (2013): p 16.13.

⁸⁸¹ Based on binned data from TMY3 & adjusted bracketed thermostat setpoint temperatures. Interpolate other values as needed.

Climate Zone Weather Station/City	T _{oc}				
	62 °F	67 °F	72 °F	77 °F	82 °F
3 - Springfield #2 / Springfield	73.7	76.7	79.9	83.4	86.4
4 - Belleville SIU RSCH / Belleville	74.9	77.7	81.0	84.3	86.9
5 - Carbondale Southern IL AP / Marion	75.1	77.7	80.9	84.7	87.4

459.7 = conversion factor from °F to °R

= calculation requires absolute temperature for values not calculated as a difference of temperatures.

Heat Transfer Through Open Entryway with Air Curtain (Cooling Season)

$$Q_{tac} = Q_{tbc} * (1 - E)$$

Where:

E = the effectiveness of the air curtain (%)
= 0.60⁸⁸²

SUMMER COINCIDENT PEAK DEMAND SAVINGS

$$\Delta kW = (\Delta kWh_{cooling} / (CD * 24)) * CF$$

Where:

CF_{SSP} = Summer System Peak Coincidence Factor for Commercial cooling (during system peak hour)
= 91.3%⁸⁸³

CF_{PJM} = PJM Summer Peak Coincidence Factor for Commercial cooling (average during peak period)
= 47.8%⁸⁸⁴

FOSSIL FUEL SAVINGS

Natural gas savings, Δtherms, associated with reduced infiltration through an entryway during the heating season are calculated by determining the difference between heat loss through the entryway before and after the installation of the air curtain.

$$\Delta \text{therms} = (Q_{bc} - Q_{ac}) * t_{open} * HD / \eta$$

Where:

Q_{bc} = rate of sensible heat transfer through the open entryway, before air curtain (therm/hr)

Q_{ac} = rate of sensible heat transfer through the open entryway, after air curtain (therm/hr)

t_{open} = average hours per day the door is open (hr/day)
= Actual or estimated user input value

HD = heating days per year, total days in year above balance point temperature (day)

⁸⁸² Assumed conservative estimate based on referenced study results and ASHRAE 2004 effectiveness range of 60-80% for air curtains. Jaramillo, Julian, et. Al. "Application of Air Curtains in Refrigerated Chambers," International Refrigeration and Air-Conditioning Conference, Purdue University e-Pubs (July 14-17, 2008).

ASHRAE, "Room Air Distribution Equipment," in 2004 ASHRAE Handbook – HVAC Systems and Equipment (2004): p 17.8.

⁸⁸³ Based on analysis of Itron eShape data for Missouri, calibrated to Illinois loads, supplied by Ameren. The AC load during the utility's peak hour is divided by the maximum AC load during the year.

⁸⁸⁴Based on analysis of Itron eShape data for Missouri, calibrated to Illinois loads, supplied by Ameren. The average AC load over the PJM peak period (1-5pm, M-F, June through August) is divided by the maximum AC load during the year

= use table below to select an appropriate value:⁸⁸⁵

Climate Zone - Weather Station/City	HD				
	45 °F	50 °F	55 °F	60 °F	65 °F
1 - Rockford AP / Rockford	142	160	183	204	228
2 - Chicago O'Hare AP / Chicago	150	166	192	219	253
3 - Springfield #2 / Springfield	125	142	167	194	230
4 - Belleville SIU RSCH / Belleville	101	115	134	156	180
5 - Carbondale Southern IL AP / Marion	103	123	148	174	205

η = efficiency of heating equipment
= Actual. If unknown, assume 0.8

Heat Transfer Through Open Entryway without Air Curtain (Heating Season)

$$Q_{bc} = (1.08 \text{ Btu}/(\text{hr} \cdot \text{°F} \cdot \text{cfm})) * \text{CFM}_{\text{tot}} * (T_{\text{ih}} - T_{\text{oh}}) / (100,000 \text{ Btu/therm})$$

Where:

1.08 = sensible heat transfer coefficient (specific heat of air and unit conversions)

CFM_{tot} = Total air flow through entryway (cfm)

T_{ih} = Average indoor air temperature during heating season
= User input, can assume indoor heating temperature set-point

T_{oh} = Average outdoor temp during heating season (°F)
= use table below, based on binned data from TMY3 & balance point temperature:

Climate Zone -Weather Station/City	Avg Outdoor Air Temp - Heating Season				
	45 °F	50 °F	55 °F	60 °F	65 °F
1 - Rockford AP / Rockford	26.3	28.8	31.6	34.2	37.3
2 - Chicago O'Hare AP / Chicago	29.4	31.2	34.0	36.8	40.3
3 - Springfield #2 / Springfield	29.4	31.5	34.6	37.7	41.6
4 - Belleville SIU RSCH / Belleville	31.7	33.6	36.2	39.2	42.3
5 - Carbondale Southern IL AP / Marion	32.5	34.9	37.8	40.7	44.0

The total airflow through the entryway, CFM_{tot} , includes both infiltration due to wind as well as thermal forces, as follows:

$$\text{CFM}_{\text{tot}} = \sqrt{[(\text{CFM}_w)^2 + (\text{CFM}_t)^2]}$$

Where:

CFM_w = Infiltration due to the wind (cfm)

CFM_t = Infiltration due to thermal forces (cfm)

The infiltration due to the wind is calculated as follows:

$$\text{CFM}_w = (v_{wh} * C_{wh}) * C_v * A_d * (88 \text{ fpm}/\text{mph})$$

Where:

v_{wh} = average wind speed during the heating season (mph)

⁸⁸⁵ Note that Heating Days (HD) are calculated following the same approach outlined in the Cooling Days section.

= similar to cooling season wind speed assumptions, use the following table to determine average wind speed based on entryway orientation:

Climate Zone -Weather Station/ City	Entryway Orientation			
	N	E	S	W
1 - Rockford AP / Rockford	5.0	4.6	4.9	5.6
2 - Chicago O'Hare AP / Chicago	5.5	5.2	4.9	5.1
3 - Springfield #2 / Springfield	5.0	4.9	5.3	5.1
4 - Belleville SIU RSCH / Belleville	4.3	3.4	3.5	5.3
5 - Carbondale Southern IL AP / Marion	4.6	3.2	4.2	4.4

C_{wh} = wind speed correction factor due to wind direction in heating season, (%)
 = because wind direction is not constant, a wind speed correction factor is used to adjust for time during the heating season that prevailing winds can be expected to impact the entryway. Use the following table to determine the correct wind speed correction factor for heating applications.

Climate Zone -Weather Station/ City	Entryway Orientation			
	N	E	S	W
1 - Rockford AP / Rockford	0.18	0.13	0.30	0.31
2 - Chicago O'Hare AP / Chicago	0.21	0.10	0.26	0.39
3 - Springfield #2 / Springfield	0.21	0.14	0.27	0.34
4 - Belleville SIU RSCH / Belleville	0.31	0.15	0.22	0.29
5 - Carbondale Southern IL AP / Marion	0.31	0.11	0.27	0.18

Note that correction factors do not add up to 1 (100%). This is attributed to periods of calm winds.

C_v = effectiveness of openings,
 = 0.3, assumes diagonal wind⁸⁸⁶
 A_d = area of the doorway (ft²)
 = user input

The infiltration due to thermal forces is calculated as follows:

$$CFM_t = A_d * C_{dh} * (60 \text{ sec/min}) * \sqrt{2 * g * H/2 * (T_{ih} - T_{oh}) / (459.7 + T_{ih})}$$

Where:

C_{dh} = the discharge coefficient during the heating season
 = $0.4 + 0.0025 * |T_{ih} - T_{oh}|$
 = 0.49, Illinois average at indoor air temp of 72°F

Note, values for C_{dh} show little variation due to balance point temperature, indoor air temperature, and climate zone. As such, if estimating results, the Illinois average value may be used as a simplification.

g = acceleration due to gravity
 = 32.2 ft/sec²
 H = the height of the entryway (ft)
 = user defined

Heat Transfer Through Open Entryway without Air Curtain (Heating Season)

⁸⁸⁶ ASHRAE, "Ventilation and Infiltration," in 2013 ASHRAE Handbook – Fundamentals (2013): p 16.13

$$Q_{ac} = Q_{bc} * (1 - E)$$

Where:

E = the effectiveness of the air curtain (%)
= 0.60⁸⁸⁷

WATER AND OTHER NON-ENERGY IMPACT DESCRIPTIONS AND CALCULATION

N/A

DEEMED O&M COST ADJUSTMENT CALCULATION

The air curtain would need to be regularly serviced and commissioned to ensure that it is appropriately operating. This is estimated at a cost of \$150.⁸⁸⁸

MEASURE CODE: CI-HVC-AIRC-V07-250101

REVIEW DEADLINE: 1/1/2027

⁸⁸⁷ Assumed conservative estimate based on referenced study results and ASHRAE 2004 effectiveness range of 60-80% for air curtains. Jaramillo, Julian, et. Al. "Application of Air Curtains in Refrigerated Chambers," International Refrigeration and Air-Conditioning Conference, Purdue University e-Pubs (July 14-17, 2008).

ASHRAE, "Room Air Distribution Equipment," in 2004 ASHRAE Handbook – HVAC Systems and Equipment (2004): p 17.8.

⁸⁸⁸ Assumes approximately 1 hour of maintenance (include cleaning out filters, greasing, and checking that the designed angle of attack on the blower nozzle is at the designed position) based on manufacturer input and product spec sheets.

4.4.34 Destratification Fan

DESCRIPTION

This measure applies to buildings with high bay ceiling construction without fans currently installed for the purpose of destratifying air. There is also a separate measure for destratification fans as applied to agricultural settings (“High Volume Low Speed Fans”). All other destratification fan applications require custom analysis.

Air stratification leads to higher temperatures at the ceiling and lower temperatures at the ground. During the heating season, destratification fans improve air temperature distribution in a space by circulating warmer air from the ceiling back down to the floor level, thereby enhancing comfort and saving energy. Energy savings are realized by a reduction of heat loss through the roof-deck and walls as a result of a smaller temperature differential between indoor temperature and outdoor air.

Note that further, but limited, empirical evidence suggests that improved air mixing due to destratification would also result in shorter heating system runtimes due to warmer air reaching the thermostat level sooner, and possibly even allow a facility to lower the thermostat set point while maintaining a similar level of occupant comfort. This is supported by measured data in which an increase in temperatures was observed at the thermostat (5 foot level) level when air is destratified, resulting in an approximate temperature increase at the 5 foot level in the range of 1 – 3°F.⁸⁸⁹ This measure does not currently attempt to quantify the potential impacts of air mixing from destratification; however, it should be noted that additional therms savings may be possible.

This measure was developed to be applicable to the following program types: NC, RF. If applied to other program types, the measure savings should be verified.

Limitations

- For use in conditioned, high bay structures. Recommended minimum ceiling height of 20 ft.
- This measure should only be applied to spaces in which the ceiling is subject to heat loss to outdoor air (i.e., single story or top floor spaces) and where there is sufficient space to allow for appropriate spacing of the fans. Other applications require custom analysis.
- Installation must follow manufacturer recommendations sufficient to effectively destratify the entire space. Please see calculation of effective area, A_{eff} , in the therms savings algorithm as a check if this criteria is met. Otherwise, custom calculation is necessary.
- Measure does not currently support facilities with night setbacks on heating equipment. Custom analysis is needed in this case.
- Certain heating systems may not be a good fit for destratification fans, such as locations with: high velocity vertical throw unit heaters, radiant heaters, and centralized forced air systems. In these cases, measured evidence of stratification should be confirmed, and custom analysis may be necessary.

DEFINITION OF EFFICIENT EQUIPMENT

High Volume, Low Speed (HVLS) fans with a minimum diameter of 14 ft with Variable Speed Drive (VSD) installed.⁸⁹⁰

Note that bell-shaped fans are currently excluded from this measure due to limited validation of the technology available. Further verification of effectiveness compared to HVLS is needed. A manufacturer of bell-shaped fans indicates that four bell-shaped fans provide an equivalent effective area as a typical HVLS fan. However, there is a need for further review of bell-shaped fan field test data supporting manufacturer claims regarding comparable effectiveness to HVLS technologies.

DEFINITION OF BASELINE EQUIPMENT

No destratification fans or other means to effectively mix indoor air.

⁸⁸⁹ Kosar, Doug, “1026: Destratification Fans – Public Project Report,” Nicor Gas, Emerging Technology Program (Oct 2014): 16.

⁸⁹⁰ Kosar, Doug, “1026: Destratification Fans – Public Project Report,” Nicor Gas, Emerging Technology Program (Oct 2014): 16.

DEEMED LIFETIME OF EFFICIENT EQUIPMENT

The expected measure life is assumed to be 10 years.⁸⁹¹

DEEMED MEASURE COST

The incremental measure cost = [equipment cost of HVLS fans] + [installation costs (including materials and labor)]

Since installation cost is dependent on a variety of factors, actual costs should be used if known. The default incremental measure cost for HVLS fans are as follows:⁸⁹²

Fan Diameter (ft)	Incremental Cost
14	\$6,600
16	\$6,650
18	\$6,700
20	\$6,750
22	\$6,800
24	\$6,850

LOADSHAPE

Loadshape C04: Commercial Electric Heating.

COINCIDENCE FACTOR

There are no summer coincident peak demand savings for this measure due to no savings attributable to cooling during the summer peak period.

Algorithm

CALCULATION OF SAVINGS

The following formulas provide a methodology for estimating heating load savings associated with destratification fan use. This algorithm is based on the assumption that savings are directly related to the difference in heat loss through the envelope before and after destratification.

ELECTRIC ENERGY SAVINGS

The algorithm for this measure was developed for natural gas heating applications, however, for electric heating applications, the same methodology presented in the Fossil Fuel Savings Section may be used with the standard conversion factor from therms to kWh of 29.31 kWh/therm and an equipment efficiency as follows:

System Type	Cooling Capacity of Equipment	Age of Equipment	HSPF Estimate	η (Effective COP Estimate) (HSPF/3.413)
Heat Pump ⁸⁹³	All	Before 2009	6.8	2.0

⁸⁹¹ Consistent with both 2008 Database for Energy-Efficient Resources, EUL/RUL (Effective/Remaining Useful Life) Values, October 10, 2008 and GDS Associates, Inc, “Measure Life Report: Residential and Commercial/Industrial Lighting and HVAC Measures,” New England Stat Program Working Group (June 2007), p30.

⁸⁹² Costs were obtained from manufacturer interviews and are based off of average or typical prices for base model HVLS fans. Costs include materials and labor to install the fans and tie fans into an existing electrical supply located near the fan.

⁸⁹³ Minimum heating efficiency standards for heat pumps are sourced from the Code of Federal Standards for Small and Large Commercial Package Air Conditioning and Heating Equipment (Air Cooled), 10 CFR 431.97 with compliance dates of June 16, 2008; January 1, 2010; January 1, 2017; January 1, 2018; and January 1, 2023. As the first federal appliance standards for

System Type	Cooling Capacity of Equipment	Age of Equipment	HSPF Estimate	η (Effective COP Estimate) (HSPF/3.413)
	< 65,000 Btu/h	2009 - 2017	7.7	2.3
		2017 on	8.2	2.40
	\geq 65,000 Btu/h and < 135,000 Btu/h	2010 -2023	11.3	3.3
		2023 on	11.6	3.4
	\geq 135,000 Btu/h and < 240,000 Btu/h	2010-2023	10.9	3.2
		2023 on	11.3	3.3
\geq 240,000 Btu/h and < 760,000 Btu/h	2010 on	10.9	3.2	
Resistance	N/A	N/A	N/A	1

Regardless of how the building is heated, the energy consumption of the fans must be accounted for. If the building is electrically heated, fan energy shall be subtracted from the savings as calculated above. If the building is heated with natural gas, this shall represent an electric penalty, i.e., an increase in consumption. This is calculated as follows:

$$\Delta kWh = - (W_{fan} * N_{fan}) * t_{eff}$$

W_{fan} = fan input power (kW)
 N_{fan} = number of fans
 t_{eff} = effective annual operation time, based on balance point temperature (hr)
 = see table below in Fossil Fuel Savings section for further detail

SUMMER COINCIDENT PEAK DEMAND SAVINGS

N/A

FOSSIL FUEL SAVINGS

$$\Delta Therms = [(\Delta Q_r + \Delta Q_w) * t_{eff}] / (100,000 * \eta)$$

Where:

- ΔQ_r = the heat loss reduction through the roof due to the destratification fan (Btu/hr)
= See calculation section below
- ΔQ_w = the heat loss reduction through the exterior walls due to destratification fan (Btu/hr)
= See calculation section below
- t_{eff} = effective annual operation time, based on balance point temperature (hr)

heating efficiency for commercial heat pumps went into effect in June 2008, assuming efficiency standards equivalent to residential heat pumps prior to that date. Note, new Federal Standards affecting heat pumps became effective January 1, 2023. In order to allow for existing inventory meeting the previous federal standards to clear shelves, this measure characterization will incorporate these federal appliance standards as an equipment efficiency option on January 1, 2024. If the application of this measure is in a new construction building, the HVAC equipment efficiency should be sourced from the applicable code edition of IECC. As code requirements and adoption can differ from municipality to municipality, the user should verify which version of code is applicable given these constraints. Note, IECC 2021 is effective statewide as of 1/1/2024. IECC 2018 is the requisite code for any projects with permitting dates spanning July 1, 2019 to 12/31/2023. Prior to July 1, 2019, IECC 2015 is the applicable code.

= use table below to select an appropriate value:⁸⁹⁴

Climate Zone -Weather Station/City	t _{eff}				
	45 °F	50 °F	55 °F	60 °F	65 °F
1 - Rockford AP / Rockford	3810	4226	4880	5571	6436
2 - Chicago O'Hare AP / Chicago	3593	3986	4603	5254	6070
3 - Springfield #2 / Springfield	3038	3370	3891	4442	5131
4 - Belleville SIU RSCH / Belleville	2243	2488	2873	3280	3789
5 - Carbondale Southern IL AP / Marion	2271	2519	2909	3320	3836

100,000 = conversion factor (1 therm = 100,000 Btu)

η = thermal efficiency of heating equipment

= Actual. If unknown, assume 0.8.

For example, for a warehouse facility located in Rockford, IL, installing destratification fans could reduce heat loss through the roof of 95,000 Btu/hr and a reduced heat loss through the wall of 51,228 Btu/hr. Assuming a balance point of 55°F the therms savings for the facility would be estimated as:

$$\begin{aligned} \Delta \text{Therms} &= [(\Delta Q_r + \Delta Q_w) * t_{\text{eff}}] / (100,000 * \eta) \\ &= [(95,000 \text{ Btu/hr} + 51,228 \text{ Btu/hr}) * 4880 \text{ hr}] / [(100,000 \text{ Btu/therm}) * 0.8] \\ &= 8,923 \text{ therms} \end{aligned}$$

Heat loss reduction through the roof

$$\begin{aligned} \Delta Q_r &= Q_{r,s} - Q_{r,d} \\ &= (1/R_r) * A_r * [(T_{r,s} - T_{oa}) - (T_{r,d} - T_{oa})] \\ &= (1/R_r) * A_r * (T_{r,s} - T_{r,d}) \end{aligned}$$

Where:

Q_{r,s} = roof heat loss for stratified space

Q_{r,d} = roof heat loss for destratified space

R_r = overall thermal resistance through the roof (hr · ft² · °F / Btu)

= Actual or estimated based on construction type. If unknown, assume the following:

Thermal Resistance Factor (R-Factor) for Roof	Retrofit ⁸⁹⁵	New Construction ⁸⁹⁶
R _r	15.0 (hr · ft ² · °F / Btu)	30.0 (hr · ft ² · °F / Btu)

A_r = roof area (ft²)

= user input

= can be approximated with floor area

⁸⁹⁴ These were calculated at various base temperatures using TMY3 data and adjusted to make consistent with the 30 year normal data used elsewhere. For more information see 'Destratification Fan Workpaper'; Robert Irmiger, Gas Technology Institute, 9/6/2015.

⁸⁹⁵ Professional judgement was used to address older vintage structures and an estimate of 50% of current code standard was used.

⁸⁹⁶ Consistent with IECC 2015/2018/2021 code requirements.

- T_{oa} = outside air temperature, note: therm savings calculations are actually independent of outside air because this term drops out of the heat loss reduction equation
- $T_{r,s}$ = indoor temperature at roof deck, stratified case (°F)
 = Actual. If unknown, use the following equation
 $= m_s * h_r + T_{f,s}$
- h_r = ceiling height/roof deck (ft)
- m_s = estimated heat gain per foot elevation, stratified case (°F/ft)
 $= 0.8 \text{ °F/ft}$
 = Professional judgement used to define value based on result from a Nicor Gas ETP Pilot field testing results and the Ansley article below.^{897,898} Estimates from these sources fall on the conservative side of the industry rule of thumb range of 1-2 °F/ft heat gain.
- $T_{f,s}$ = estimated floor temperature, stratified case (°F)
 $= T_{tstat} - m_s * h_{tstat}$
 $= T_{tstat} - 4 \text{ °F}$
- T_{tstat} = temperature set point at the thermostat
- h_{tstat} = vertical distance between the floor and the thermostat, assumed 5ft
- $T_{r,d}$ = indoor temp at roof, destratified case
 = actual value, or may be estimated using the following:^{899,900}
 $= T_{tstat} + 1 \text{ °F}$

For example, for a 50,000 ft² warehouse built in 1997 with 30 ft ceilings and a thermostat set point of 65°F. No further measured values available.

$$\begin{aligned} \Delta Q_r &= (1/R_r) * A_r * (T_{r,s} - T_{r,d}) = (1/R_r) * A_r * [(m_s * h_r + T_{tstat} - 4 \text{ °F}) - (T_{tstat} + 1 \text{ °F})] \\ &= (1/R_r) * A_r * [(0.8 \text{ °F/ft} * h_r) - 5 \text{ °F}] \\ &= 1/(10 \text{ hr} \cdot \text{ft}^2 \cdot \text{°F} / \text{Btu}) * (50,000 \text{ ft}^2) * [(0.8 \text{ °F/ft} * 30 \text{ ft}) - 5 \text{ °F}] \\ &= 95,000 \text{ Btu/hr} \end{aligned}$$

Heat loss reduction through exterior walls

Note: a conservative estimate for therms savings would neglect the impact of heat loss through the walls. However, Ansley suggests that estimates based on the roof deck losses alone underestimate actual savings by up to 46%.⁹⁰¹

$$\begin{aligned} \Delta Q_w &= Q_{w,s} - Q_{w,d} \\ &= (1/R_w) * A_w * (T_{w,s} - T_{w,d}) \end{aligned}$$

Where:

⁸⁹⁷ Kosar, Doug, “1026: Destratification Fans – Public Project Report,” Nicor Gas, Emerging Technology Program (Oct 2014): 10-11. Field testing results indicated approximately 0.6 °F/ft for a garden center.

⁸⁹⁸ Aynsley, Richard, “Saving Heating Costs in Warehouses,” ASHRAE Journal (Dec 2005): 48. Identifies a 0.8 °F/ft gain.

⁸⁹⁹ Kosar, Doug, “1026: Destratification Fans – Public Project Report,” Nicor Gas, Emerging Technology Program (Oct 2014): 10-11. Field testing results indicated approximately 0.6 °F/ft for a garden center.

⁹⁰⁰ Aynsley, Richard, “Saving Heating Costs in Warehouses,” ASHRAE Journal (Dec 2005): 48.

⁹⁰¹ Aynsley, Richard, “Saving Heating Costs in Warehouses,” ASHRAE Journal (Dec 2005): 51.

R_w = overall thermal resistance through the exterior walls ($hr \cdot ft^2 \cdot ^\circ F / Btu$)
 = Actual or estimated based on construction type.⁹⁰² If unknown, assume the following:

Thermal Resistance Factor (R-Factor) for Wall	Retrofit ⁹⁰³	New Construction ⁹⁰⁴ (2010 or newer)
R_w	6.5 ($hr \cdot ft^2 \cdot ^\circ F / Btu$)	13.0 ($hr \cdot ft^2 \cdot ^\circ F / Btu$)

A_w = area of exterior walls (ft^2)
 = user input

$T_{w,s}$ = average indoor air temperature for wall heat loss, stratified case
 = If actual $T_{r,s}$ measurement is available⁹⁰⁵

$$= [(T_{r,s} * h_a) + (T_{tstat} * h_b)] / h_r$$

$$h_a = \text{vertical distance between the heat source and the ceiling}$$

$$h_b = \text{vertical distance between the floor and the heat source}$$
 = Otherwise, use the linear stratification equation at average space height, see definition above.

$$= m_s * (h_r / 2) + T_{f,s}$$

$$= m_s * (h_r / 2) + (T_{tstat} - 4)$$

$T_{w,d}$ = average indoor air temperature for wall heat loss, destratified case

$$= T_{tstat} + 0.5$$
 = conservative estimate using engineering judgment based on the same assumption used for $T_{r,f}$ estimate.

For example, for a 50,000 ft^2 warehouse built in 1997 with 1200 ft length of perimeter wall and 30 ft ceilings and a thermostat set point of 65°F and a measured temperature at the ceiling of 85°F and unit heaters located 10 feet from the roof:

$$\begin{aligned} \Delta Q_w &= (1/R_w) * A_w * (T_{w,s} - T_{w,d}) \\ &= (1/R_w) * A_w * [([(T_{r,s} * h_a) + (T_{tstat} * h_b)] / h_r) - (T_{tstat} + 0.5 \text{ } ^\circ F)] \\ &= 1/(6.5 \text{ hr}\cdot\text{ft}^2\cdot^\circ\text{F}/\text{Btu}) * (1200 * 30) * [([(85^\circ\text{F} * 10\text{ft}) + (65^\circ\text{F} * 20\text{ft})] / 30\text{ft}) - (65 + 0.5 \text{ } ^\circ\text{F})] \\ &= 1/(6.5 \text{ hr}\cdot\text{ft}^2\cdot^\circ\text{F}/\text{Btu}) * (36,000\text{ft}^2) * (71.7 \text{ } ^\circ\text{F} - 65.5 \text{ } ^\circ\text{F}) \\ &= 34,338 \text{ Btu/hr} \end{aligned}$$

Measure eligibility check

Use the following algorithm to verify a fan system is sufficiently sized to destratify air across the entire area.

⁹⁰² Because heat loss through the walls is estimated using the average space temperature pre- and post- destratification. There are a number of factors that can impact the average space temperature causing deviations from estimates of many degrees in some cases. As such, it is recommended that a conservative value for the thermal resistance through the walls, R_w , be used. A recommended method for determining R_w would be to use the highest R-value for the wall space, neglecting lower R-values associated with windows, thermal bridges, etc.

⁹⁰³ANSI/ASHRAE/IESNA 100-1995, “Energy Conservation in Existing Buildings,” ASHRAE Standard (1995). Additionally, professional judgement was used to address older vintage structure prior to adoption of the 1995 standard and an estimate of 50% of current code standard was used.

⁹⁰⁴ANSI/ASHRAE/IESNA Standard 90.1-2007, “Energy Standard for Buildings Except Low-Rise Residential Buildings,” ASHRAE Standard (2007): Table 5.5-4 and Table 5.5-5.

⁹⁰⁵ Aynsley, Richard, “Saving Heating Costs in Warehouses,” ASHRAE Journal (Dec 2005): 48.

Effective area, A_{eff} , is the area over which a fan or a group of fans can be expected to effectively destratify a space. If A_{eff} is less than the roof area, A_r , a custom analysis approach should be followed to account for the change in the effectiveness of the system. In lieu of more detailed studies, effective area is defined based on the measured results from an Enbridge Gas field study in which the area a fan was expected to effectively destratify was equal to 5 times the fan diameter.⁹⁰⁶ Effective area, is calculated as follows:

$$A_{eff} = [\pi * (5 * D_{fan})^2] / 4 * N_{fan}$$

$$= 6.25 * \pi * D_{fan}^2 * N_{fan}$$

Where:

A_{eff} = the effective area fan area on the floor (ft²)

D_{fan} = fan diameter

N_{fan} = the number of fans

WATER IMPACT DESCRIPTIONS AND CALCULATION

N/A

DEEMED O&M COST ADJUSTMENT CALCULATION

N/A

MEASURE CODE: CI-HVC-DSFN-V08-250101

REVIEW DEADLINE: 1/1/2030

⁹⁰⁶ Enbridge Gas Distribution, Inc., “Big Fans Deliver Big Bonus,” (Aug 2007). Additionally, multiple utilities have adopted this definition in their programs in including Enbridge Gas and Consumers Energy.

4.4.35 Economizer Repair and Optimization

DESCRIPTION

Economizers are designed to use unconditioned outside air (OA) instead of mechanical cooling to provide cooling when exterior conditions permit. When the OA temperature is less than the changeover temperature (determined by a static setpoint or a reference return air sensor) up to 100% OA is supplied to help meet the facility's cooling needs, thus reducing mechanical cooling energy and saving energy. An economizer that is not working or is not properly adjusted can waste energy and cause comfort issues. This HVAC measure involves the repair and optimization of common economizer problems such as adjusting changeover setpoint, repairing damper motors and linkages, and replacing non-working sensors and/or controllers. These repairs and adjustments result in proper operation which maximizes both occupant comfort and energy savings.

This measure is only appropriate for single zone packaged rooftop units. Custom calculations are required for savings for multi-zone systems.

In general, the HVAC Economizer Optimization measure may involve both repair and/or optimization, as below.

Economizer Repair – The economizer repair work is preformed to ensure that the existing economizer is working properly. This allows the system to take advantage of free cooling and ensure that the system is not supplying an excess amount of OA during non-economizing periods.

- **Replace Damper Motor** – If the existing damper motor is not operational, the unit will be replaced with a functioning motor to allow proper damper modulation.
- **Repair Damper Linkage** – If the existing linkage is broken or not adjusted properly, the unit will be replaced or adjusted to allow proper damper modulation.
- **Repair Economizer Wiring** – If the existing economizer is not operational due to a wiring issue, the issue will be repaired to allow proper economizer operation.
- **Reduce Over Ventilation** – If the unit is supplying excess OSA, the OSA damper position will be adjusted to meet minimum ventilation requirements.
- **Replace Economizer Sensor**– If the unit is equipped with a nonadjustable dry bulb (i.e., snapdisk) or malfunctioning analog sensor, the sensor is replaced with a new selectable sensor.
- **Replace Economizer Control**– If the existing economizer controller is not operational, the unit will be replaced or upgraded to allow for proper economizer operation.

Economizer Optimization – The economizer optimization work is preformed to ensure that the existing economizer system is set up properly to maximize use of free cooling for units located in a particular climate zone.

- **Economizer Changeover Setpoint Adjustment** – If the unit is equipped with a fully operational economizer, the controller is adjusted to the appropriate changeover setpoint based on ASHRAE 90.1 (Figure 1 - *Table 6.5.1.1.3 High-Limit Shutoff Control Settings for Air Economizers*) for the corresponding climate zone.
- **Enable Integrated Operation** – If the unit is equipped with a fully operational economizer and is not set up to allow a minimum of two stages of cooling (1st stage – Economizer Only & 2nd Stage – Economizer & Mechanical cooling), the unit will be wired to allow two stage cooling

This measure was developed to be applicable to the following program types: RF, DI.

If applied to other program types, the measure savings should be verified.

DEFINITION OF EFFICIENT EQUIPMENT

The efficient equipment condition is defined by fully functional economizer that is programmed to meet ASHRAE 90.1 economizer changeover setpoint requirements for the facility’s climate zone and changeover control type (Figure 1 - Table 6.5.1.1.3 High-Limit Shutoff Control Settings for Air Economizers).⁹⁰⁷

Figure 1 – Baseline ASHRAE High-Limit Shutoff Control Settings

TABLE 6.5.1.1.3 High-Limit Shutoff Control Settings for Air Economizers^b

Control Type	Allowed Only in Climate Zone at Listed Setpoint	Required High-Limit Setpoints (Economizer Off When):	
		Equation	Description
Fixed dry-bulb temperature	1b, 2b, 3b, 3c, 4b, 4c, 5b, 5c, 6b, 7, 8	$T_{OA} > 75^{\circ}\text{F}$	Outdoor air temperature exceeds 75°F
	5a, 6a	$T_{OA} > 70^{\circ}\text{F}$	Outdoor air temperature exceeds 70°F
	1a, 2a, 3a, 4a,	$T_{OA} > 65^{\circ}\text{F}$	Outdoor air temperature exceeds 65°F
Differential dry-bulb temperature	1b, 2b, 3b, 3c, 4b, 4c, 5a, 5b, 5c, 6a, 6b, 7, 8	$T_{OA} > T_{RA}$	Outdoor air temperature exceeds return air temperature
Fixed enthalpy with fixed dry-bulb temperature	All	$h_{OA} > 28 \text{ Btu/lb}^a$ or $T_{OA} > 75^{\circ}\text{F}$	Outdoor air enthalpy exceeds 28 Btu/lb ^a of dry air ^a or outdoor air temperature exceeds 75°F
Differential enthalpy with fixed dry-bulb temperature	All	$h_{OA} > h_{RA}$ or $T_{OA} > 75^{\circ}\text{F}$	Outdoor air enthalpy exceeds return air enthalpy or outdoor air temperature exceeds 75°F

a. At altitudes substantially different than sea level, the fixed enthalpy limit shall be set to the enthalpy value at 75°F and 50% RH. As an example, at approximately 6000 ft elevation, the fixed enthalpy limit is approximately 30.7 Btu/lb.
 b. Devices with selectable rather than adjustable setpoints shall be capable of being set to within 2°F and 2 Btu/lb of the setpoint listed.

Figure 2 – ASHRAE Climate Zone Map

**NORMATIVE APPENDIX B
CLIMATE ZONES FOR U.S. STATES AND COUNTIES**

This normative appendix provides the climate zones for U.S. states and counties. Figure B-1 contains the county-level climate zone map for the United States. Table B-1 lists each state and major counties within the state and shows the climate number and letter for each county listed.

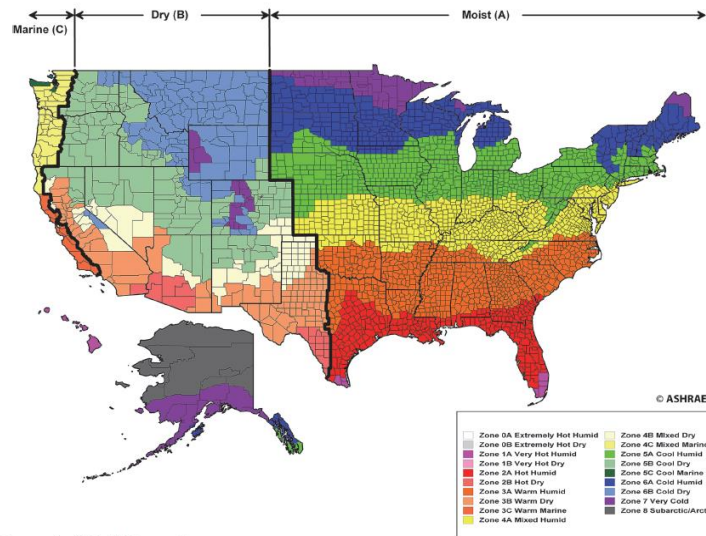

FIGURE B-1 Climate zones for United States counties.

DEFINITION OF BASELINE EQUIPMENT

The baseline for this measure is an existing economizer installed on a packaged single zone rooftop HVAC unit. The existing economizer system is currently not operating as designed due to mechanical and/or control problems, and/or is not optimally adjusted.

⁹⁰⁷ ASHRAE, Standard 90.1-2013

DEEMED LIFETIME OF EFFICIENT EQUIPMENT

The measure life is assumed to be 5 years.⁹⁰⁸

DEEMED MEASURE COST

The cost for this measure can vary considerably depending upon the existing condition of the economizer and the work required to achieve the required efficiency levels. Measure cost should be determined on a site-specific basis.

LOADSHAPE

Loadshape C03 - Commercial Cooling

COINCIDENCE FACTOR

N/A

Algorithm

CALCULATION OF ENERGY SAVINGS

The savings calculation methodology uses a regression equation to calculate the energy savings for a variety of common situations.⁹⁰⁹ The equation variables are limited to the ranges listed; if the actual conditions fall outside of these ranges, custom calculations are required.

ELECTRIC ENERGY SAVINGS

$$\Delta \text{kWh} = [\text{Baseline Energy Use (kWh/ton)} - \text{Proposed Energy Use (kWh/ton)}] * \text{Cooling Capacity (Tons)}$$

The following equations are used to calculate baseline and proposed electric energy use.⁹¹⁰

Changeover types: Fixed Dry-Bulb (DB), Dual Temperature Dry-Bulb (DTDB), Dual Temperature Enthalpy (DTEnth), Fixed Enthalpy (Enth), and Analog ABCD Economizers (ABCD).

Electric Energy Use Equations (kWh/ton):

Building Type	Changeover Type	Equation
Assembly	DB	$CZ + CSP*(-2.021) + EL*(-16.362 + OAn*1.665 + OAx*(-3.13))$
	DTDB	$CZ + EL*(-11.5) + OAn*1.635 + OAx*(-2.817)$
	DTEnth	$CZ + EL*(-17.772) + OAn*1.853 + OAx*(-3.044)$
	Enth	$CZ + CSP*(-5.228) + EL*(-17.475) + OAn*1.765 + OAx*(-3.003)$
	ABCD	$CZ + CSP*(-2.234) + EL*(-16.394) + OAn*1.744 + OAx*(-3.01)$
Convenience Store	DB	$CZ + CSP*(-3.982) + EL*(-27.508) + OAn*2.486 + OAx*(-4.684)$
	DTDB	$CZ + EL*(-20.798) + OAn*2.365 + OAx*(-3.773)$
	DTEnth	$CZ + EL*(-30.655) + OAn*2.938 + OAx*(-4.461)$
	Enth	$CZ + CSP*(-8.648) + EL*(-25.678) + OAn*2.092 + OAx*(-3.754)$
	ABCD	$CZ + CSP*(-3.64) + EL*(-24.927) + OAn*2.09 + OAx*(-3.788)$
	DB	$CZ + CSP*(-0.967) + EL*(-6.327) + OAn*2.87 + OAx*(-1.047)$

⁹⁰⁸ DEER 2014 (DEER2014 EUT Table D08 v2.05).

⁹⁰⁹ For more information on methodology, please refer to workpaper submitted by CLEAResult titled "CLEAResult_Economizer Repair_151020_Finalv2.doc". Note that the original ComEd eQuest models were used in the analysis, rather than the VEIC developed models used elsewhere. VEIC do not consider this a significant issue as adjustments from the ComEd models were focused on calibrating EFLH values, not to overall energy use metrics. We also believe using the ComEd models is likely more conservative. It may be appropriate to update the analysis with the updated models at a later time.

⁹¹⁰ This approach allows the savings estimate to account for the operational attributes of the baseline as well as the proposed case, yielding a better estimate than an approach that assumes a particular baseline or proposed energy use to determine savings.

Building Type	Changeover Type	Equation
Office - Low Rise	DTDB	$CZ + OAn * 2.968 + OAx * (-0.943)$
	DTEnth	$CZ + EL * (-9.799) + OAn * 3.106 + OAx * (-1.085)$
	Enth	$CZ + CSP * (-2.773) + EL * (-7.392) + OAn * 2.941 + OAx * (-0.974)$
	ABCD	$CZ + CSP * (-1.234) + EL * (-7.229) + OAn * 2.936 + OAx * (-0.995)$
Religious Facility	DB	$CZ + CSP * (-1.131) + OAn * 3.542 + OAx * (-1.01)$
	DTDB	$CZ + EL * (-10.198) + OAn * 4.056 + OAx * (-1.279)$
	DTEnth	$CZ + OAn * 3.775 + OAx * (-1.031)$
	Enth	$CZ + CSP * (-2.13) + OAn * 3.317 + OAx * (-0.629)$
	ABCD	$CZ + CSP * (-0.95) + OAn * 3.313 + OAx * (-0.647)$
Restaurant	DB	$CZ + CSP * (-2.243) + EL * (-21.523) + OAx * (-1.909)$
	DTDB	$CZ + EL * (-14.427) + OAn * 0.295 + OAx * (-1.451)$
	DTEnth	$CZ + EL * (-25.99) + OAn * 0.852 + OAx * (-1.951)$
	Enth	$CZ + CSP * (-4.962) + EL * (-16.868) + OAn * (-0.12) + OAx * (-1.418)$
	ABCD	$CZ + CSP * (-2.115) + EL * (-16.15) + OAn * (-0.125) + OAx * (-1.432)$
Retail - Department Store	DB	$CZ + CSP * (-1.003) + OAn * 3.765 + OAx * (-0.938)$
	DTDB	$CZ + OAn * 3.688 + OAx * (-0.676)$
	DTEnth	$CZ + OAn * 4.081 + OAx * (-1.072)$
	Enth	$CZ + CSP * (-2.545) + OAn * 3.725 + OAx * (-0.788)$
	ABCD	$CZ + CSP * (-1.175) + OAn * 3.708 + OAx * (-0.809)$
Retail - Strip Mall	DB	$CZ + CSP * (-1.192) + EL * (-5.62) + OAn * 3.353 + OAx * (-1.142)$
	DTDB	$CZ + OAn * 3.355 + OAx * (-0.915)$
	DTEnth	$CZ + EL * (-9.202) + OAn * 3.642 + OAx * (-1.215)$
	Enth	$CZ + CSP * (-2.997) + EL * (-5.938) + OAn * 3.312 + OAx * (-0.964)$
	ABCD	$CZ + CSP * (-1.36) + EL * (-5.884) + OAn * 3.3 + OAx * (-0.987)$

Where:

CZ = Climate Zone Coefficient

= Depends on Building Type and Changeover Type (see table below)

Building Type	Changeover Type	Electric Climate Zone Coefficients				
		CZ1 (Rockford)	CZ2 (Chicago)	CZ3 (Springfield)	CZ4 (Belleville)	CZ5 (Marion)
Assembly	DB	874.07	886.73	1043.38	1071.48	1072.20
	DTDB	698.45	711.89	870.13	899.51	903.10
	DTEnth	702.06	715.42	873.43	902.76	906.50
	Enth	851.95	865.43	1020.65	1047.10	1053.32
	ABCD	884.19	897.63	1053.12	1080.58	1086.35
Convenience Store	DB	1739.12	1787.09	2128.78	2206.65	2245.93
	DTDB	1389.28	1436.30	1780.99	1863.45	1904.89
	DTEnth	1398.42	1446.82	1789.71	1869.89	1912.59
	Enth	1643.51	1691.34	2032.83	2112.21	2157.63
	ABCD	1692.80	1740.62	2082.35	2162.73	2207.68
Office - Low Rise	DB	674.06	687.17	899.17	993.84	989.16
	DTDB	583.62	597.02	811.39	907.61	903.58

Building Type	Changeover Type	Electric Climate Zone Coefficients				
		CZ1 (Rockford)	CZ2 (Chicago)	CZ3 (Springfield)	CZ4 (Belleville)	CZ5 (Marion)
	DTEnth	588.94	602.11	816.02	912.49	908.26
	Enth	668.83	682.23	893.61	987.52	986.59
	ABCD	690.27	703.52	915.27	1009.94	1008.59
Religious Facility	DB	613.26	630.50	853.53	923.99	931.74
	DTDB	518.40	535.45	760.76	832.57	840.72
	DTEnth	513.59	531.20	756.26	829.13	837.26
	Enth	576.94	594.17	817.64	888.37	897.18
	ABCD	593.78	611.04	834.69	905.83	914.27
Restaurant	DB	1397.27	1430.45	1763.21	1837.63	1872.18
	DTDB	1191.82	1225.12	1558.32	1633.95	1669.13
	DTEnth	1192.84	1226.77	1559.41	1635.13	1671.11
	Enth	1343.56	1377.52	1710.11	1783.66	1821.67
	ABCD	1373.72	1407.70	1740.43	1814.74	1852.55
Retail - Department Store	DB	717.89	730.07	968.85	1034.78	1035.06
	DTDB	628.83	641.70	883.37	951.09	951.33
	DTEnth	629.35	641.90	882.84	951.33	951.44
	Enth	705.06	717.99	956.42	1020.57	1024.45
	ABCD	728.60	741.47	980.19	1045.30	1048.57
Retail - Strip Mall	DB	800.69	818.68	1070.39	1129.87	1133.84
	DTDB	692.97	711.31	965.63	1026.68	1030.41
	DTEnth	698.12	716.34	970.06	1031.78	1035.72
	Enth	784.54	803.35	1054.37	1112.72	1120.74
	ABCD	810.10	828.86	1080.11	1139.39	1146.95

CSP = Economizer Changeover Setpoint (°F or Btu/lb) (actual in ranges below)

Economizer Control Type		Economizer Changeover Setpoint
Dry-Bulb		60°F – 80°F
Dual Temperature Dry-Bulb		0°F – 5°F delta
Dual Temperature Enthalpy		0 Btu/lb – 5 Btu/lb delta
Enthalpy		18 Btu/lb – 28 Btu/lb
Analog ABCD Economizers	A	73°F
	B	70°F
	C	67°F
	D	63°F
	E	55°F

EL = Integrated Economizer Operation (Economizer Lockout)
 = 1 for Economizer w/ Integrated Operation (Two Stage Cooling)
 = 0 for Economizer w/ out Integrated Operation (One Stage Cooling)

OAn = Minimum Outside Air (%OA * 100)⁹¹¹

= Actual. %OA must be between 15% and 70%. If unknown, assume:

- Functional Economizer – 30%
- Nonfunctional Economizer (Damper failed closed) – 15%
- Nonfunctional Economizer (Damper failed open) – 30% (assume Minimum Ventilation (Three Fingers))⁹¹²

Note: the actual integer Oan value (e.g., 30) should be used in the regression algorithm, not the percentage (e.g., 0.3).

OAx = Maximum Outside Air (%)

= Actual. Must be between 15% and 70%. If unknown, assume:

- Functional Economizer – 70%
- Nonfunctional Economizer (Damper failed closed) – 15%
- Nonfunctional Economizer (Damper failed open) – 30% (assume Minimum Ventilation (Three Fingers))

For example, a low-rise office building in Rockford (Climate Zone 1) is heated and cooled with a packaged Gas (92 kBtu output) / DX (5 ton) RTU. The RTU is equipped with a fixed dry bulb outside air economizer and is programmed for integrated operation. When the technician inspects the RTU they find that the changeover setpoint is programmed to 62°F, which does not meet ASHRAE economizer high limit shut off air economizer recommendations. After further investigation it is found that the OA damper motor is not operational and is providing 30% outside air.

The technician replaces the damper motor and allow for proper OA damper modulation (30% Min OA & 70% Max OA). They also adjust the fixed dry-bulb changeover setpoint to meet the ASHRAE economizer high limit shut off air economizer recommendation of 70°F.

$$\Delta kWh = [\text{Baseline Energy Use (kWh/ton)} - \text{Proposed Energy Use (kWh/ton)}] * \text{Cooling Capacity (tons)}$$

Baseline Energy Use (kWh/ton) = Equation for Office Low Rise

$$\begin{aligned} &= CZ + CSP*(-0.967) + EL*(-6.327) + OAn*2.87 + OAx*(-1.047) \\ &= 674.06 + 62*(-0.967) + 0*(-6.327) + 30*2.87 + 30*(-1.047) \\ &= 668.8 \text{ kWh/ton} \end{aligned}$$

Proposed Energy Use (kWh/ton) = Equation for Office Low Rise

$$\begin{aligned} &= CZ + CSP*(-0.967) + EL*(-6.327) + OAn*2.87 + OAx*(-1.047) \\ &= 674.06 + 70*(-0.967) + 0*(-6.327) + 30*2.87 + 70*(-1.047) \\ &= 619.2 \text{ kWh/ton} \end{aligned}$$

$$\begin{aligned} \Delta kWh &= [668.8 \text{ (kWh/ton)} - 619.2 \text{ (kWh/ton)}] * 5 \text{ tons} \\ &= 49.6 \text{ kWh/ton} * 5 \text{ tons} \\ &= 248.08 \text{ kWh} \end{aligned}$$

SUMMER COINCIDENT PEAK DEMAND SAVINGS

N/A - It is assumed that repair or optimization of the economizer will not typically have a significant impact summer peak demand.

⁹¹¹ DNV GL, "HVAC Impact Evaluation Final Report WO32 HVAC – Volume 1: Report," California Public Utilities Commission, Energy Division, HVAC Commercial Quality Maintenance (CQM) (1/28/14).

⁹¹² Technician rule of thumb taken from CPUC 'HVAC Impact Evaluation Final Report', WO32, 28Jan 2015, p18.

FOSSIL FUEL SAVINGS

$$\Delta\text{Therms} = [\text{Baseline Energy Use (Therms/kBtuh)} - \text{Proposed Energy Use (Therms/kBtuh)}] * \text{Output Heating Capacity (kBtuh)}$$

The following equations are used to calculate baseline and proposed electric energy use.

Natural Gas Energy Use Equations (therms / kbtu output)

Building Type	Changeover Type	Equation
Assembly	DB	$CZ + OAn * 0.0853$
	DTDB	$CZ + OAn * 0.0866$
	DTEnth	$CZ + OAn * 0.0866$
	Enth	$CZ + OAn * 0.0855$
	ABCD	$CZ + OAn * 0.0855$
Convenience Store	DB	$CZ + OAn * 0.26$
	DTDB	$CZ + OAn * 0.263$
	DTEnth	$CZ + OAn * 0.263$
	Enth	$CZ + OAn * 0.261$
	ABCD	$CZ + OAn * 0.261$
Office - Low Rise	DB	$CZ + OAn * 0.3$
	DTDB	$CZ + OAn * 0.301$
	DTEnth	$CZ + OAn * 0.301$
	Enth	$CZ + OAn * 0.3$
	ABCD	$CZ + OAn * 0.3$
Religious Facility	DB	$CZ + OAn * 0.35$
	DTDB	$CZ + OAn * 0.348$
	DTEnth	$CZ + OAn * 0.348$
	Enth	$CZ + OAn * 0.349$
	ABCD	$CZ + OAn * 0.349$
Restaurant	DB	$CZ + OAn * 0.0867$
	DTDB	$CZ + OAx * (-0.038) + OAn * OAx * 0.00149$
	DTEnth	$CZ + OAx * (-0.038) + OAn * OAx * 0.00149$
	Enth	$CZ + OAn * 0.0878$
	ABCD	$CZ + OAn * 0.0878$
Retail - Department Store	DB	$CZ + OAn * 0.319$
	DTDB	$CZ + OAn * 0.318$
	DTEnth	$CZ + OAn * 0.318$
	Enth	$CZ + OAn * 0.318$
	ABCD	$CZ + OAn * 0.318$
Retail - Strip Mall	DB	$CZ + OAn * 0.215$
	DTDB	$CZ + OAn * 0.216$
	DTEnth	$CZ + OAn * 0.216$
	Enth	$CZ + OAn * 0.215$
	ABCD	$CZ + OAn * 0.215$

Where:

- CZ = Climate Zone Coefficient
- = Depends on Building Type and Changeover Type (see table below)

Building Type	Changeover Type	Natural Gas Climate Zone Coefficients				
		CZ1 (Rockford)	CZ2 (Chicago)	CZ3 (Springfield)	CZ4 (Belleville)	CZ5 (Marion)
Assembly	DB	-0.03	-0.55	-1.06	-1.28	-1.71
	DTDB	-0.02	-0.57	-1.11	-1.34	-1.79
	DTEnth	-0.02	-0.57	-1.11	-1.34	-1.79
	Enth	-0.03	-0.55	-1.06	-1.29	-1.72
	ABCD	-0.03	-0.55	-1.06	-1.29	-1.72
Convenience Store	DB	2.95	0.50	-1.48	-2.96	-5.56
	DTDB	3.06	0.52	-1.56	-3.11	-5.81
	DTEnth	3.06	0.52	-1.56	-3.11	-5.81
	Enth	2.96	0.50	-1.49	-2.98	-5.59
	ABCD	2.96	0.50	-1.49	-2.98	-5.59
Office - Low Rise	DB	5.83	3.02	0.46	-0.92	-4.13
	DTDB	5.98	3.08	0.41	-1.03	-4.36
	DTEnth	5.98	3.08	0.41	-1.03	-4.36
	Enth	5.85	3.03	0.46	-0.93	-4.16
	ABCD	5.85	3.03	0.46	-0.93	-4.16
Religious Facility	DB	9.23	6.71	3.75	2.40	-0.80
	DTDB	9.41	6.83	3.77	2.39	-0.86
	DTEnth	9.41	6.83	3.77	2.39	-0.86
	Enth	9.25	6.73	3.75	2.40	-0.80
	ABCD	9.25	6.73	3.75	2.40	-0.80
Restaurant	DB	8.30	6.54	4.94	4.00	1.95
	DTDB	10.51	8.71	7.07	6.10	4.00
	DTEnth	10.51	8.71	7.07	6.10	4.00
	Enth	8.28	6.51	4.91	3.96	1.90
	ABCD	8.28	6.51	4.91	3.96	1.90
Retail - Department Store	DB	8.20	5.86	3.19	1.25	-2.59
	DTDB	8.35	5.94	3.18	1.18	-2.75
	DTEnth	8.35	5.94	3.18	1.18	-2.75
	Enth	8.21	5.87	3.18	1.24	-2.61
	ABCD	8.21	5.87	3.18	1.24	-2.61
Retail - Strip Mall	DB	6.40	4.35	2.07	0.49	-2.18
	DTDB	6.51	4.38	2.03	0.39	-2.34
	DTEnth	6.51	4.38	2.03	0.39	-2.34
	Enth	6.41	4.35	2.06	0.48	-2.20
	ABCD	6.41	4.35	2.06	0.48	-2.20

For example, a low-rise office building in Rockford (Climate Zone 1) is heated and cooled with a packaged Gas (92 kBtu output) / DX (5 ton) RTU. The RTU is equipped with a fixed dry bulb outside air economizer and is programmed for integrated operation. When the technician inspects the RTU they find that the changeover setpoint is programmed to 62°F, which does not meet ASHRAE economizer high limit shut off air economizer recommendations. After further investigation it is found the OA damper motor is not operational and is providing 30% outside air.

The technician replaces the damper motor and allow for proper OA damper modulation (30% Min OA & 70% Max OA). They also adjust the fixed dry-bulb changeover setpoint to meet the ASHRAE economizer high limit shut off air economizer recommendation of 70°F.

$$\Delta\text{Therms} = [\text{Baseline Energy Use (Therms/kBtuh)} - \text{Proposed Energy Use (Therms/kBtuh)}] * \text{Output Heating Capacity (kBtuh)}$$

$$\text{Baseline Energy Use (Therms/kBtuh)} = \text{Equation for Office Low Rise}$$

$$= \text{CZ} + \text{OAn} * 0.3$$

$$= 5.83 + 30 * 0.3$$

$$= 14.8 \text{ Therms/kBtuh output}$$

$$\text{Proposed Energy Use (Therms/kBtuh)} = \text{Equation for Office Low Rise}$$

$$= \text{CZ} + \text{OAn} * 0.3$$

$$= 5.83 + 30 * 0.3$$

$$= 14.8 \text{ Therms/kBtuh output}$$

$$\Delta\text{Therms} = [14.8(\text{Therms/kBtuh output}) - 14.8(\text{Therms/kBtuh output})] * 92\text{kBtuh output}$$

$$= 0.0(\text{Therms/kBtuh output}) * 92\text{kBtuh output}$$

$$= 0 \text{ Therms}$$

WATER IMPACT DESCRIPTIONS AND CALCULATION

N/A

DEEMED O&M COST ADJUSTMENT CALCULATION

N/A

MEASURE CODE: CI-HVC-ECRP-V05-230101

REVIEW DEADLINE: 1/1/2026

4.4.36 Multi-Family Space Heating Steam Boiler Averaging Controls

DESCRIPTION

This measure covers multi-family space heating boiler averaging controls. Temperature sensors are placed in interior spaces to monitor the average temperature of the building. At a minimum, a sensor must be placed at each corner and at one central location. Additionally, a temperature sensor must monitor the outside air temperature. These sensors shall provide data to the averaging controls. The averaging controls will adjust the boiler operation based upon an average of the indoor sensors and the outside air temperature. These controls shall also incorporate a nighttime setback capability. Buildings utilizing thermostatic radiator valves, or other modulating control valves or sequences to control the temperature in individual spaces, are not eligible.

This measure was developed to be applicable to the following program types: RF.

DEFINITION OF EFFICIENT EQUIPMENT

To qualify the boiler(s) must incorporate an averaging control system utilizing at least 4 indoor sensors and 1 outdoor sensor. The controls shall have the capability to incorporate a nighttime setback throughout the building.

DEFINITION OF BASELINE EQUIPMENT

The baseline is a boiler system without averaging controls or other steam supply modulating controls. Current boiler control system can utilize a single thermostat or aquastat and timer.

DEEMED LIFETIME OF EFFICIENT EQUIPMENT

The measure life for the domestic hot water boiler(s) is 20 years.⁹¹³

DEEMED MEASURE COST

As a retrofit measure, the actual installed cost should be used for screening purposes. A deemed retrofit measure cost of \$5,060 can be used if the actual installed cost is unknown.⁹¹⁴

LOADSHAPE

N/A

COINCIDENCE FACTOR

N/A

Algorithm

CALCULATION OF SAVINGS

ELECTRIC ENERGY SAVINGS

N/A

SUMMER COINCIDENT PEAK DEMAND SAVINGS

N/A

FOSSIL FUEL SAVINGS

$$\Delta\text{Therms} = \text{Capacity} * \text{EFLH} * \text{SF} / 100,000$$

Where:

⁹¹³ The Brooklyn Union Gas Company, High Efficiency Heating and Water and Controls, Gas Energy Efficiency Program Implementation Plan.

⁹¹⁴ NREL, "Steam Balancing and Tuning for Multifamily Residential Buildings in Chicagoland-Second Year of Data Collection", August 2013.

Capacity	= Boiler gas input size (Btu/h) = Actual
EFLH	= Effective Full Load Hours for heating in Existing Buildings are provided in section 4.4. HVAC End Use
SF	= Savings Factor = 10.2%, ⁹¹⁵ or custom if savings can be substantiated
100,000	= converts Btu/h to therm

For example, a 1,000,000 btu/h steam boiler in a Mid-Rise Multi-Family building in Chicago has averaging controls installed.

$$\begin{aligned}\Delta\text{Therms} &= 1,000,000 * 1,685 * 0.102 / 100,000 \\ &= 1,719 \text{ therms}\end{aligned}$$

WATER IMPACT DESCRIPTIONS AND CALCULATION

N/A

DEEMED O&M COST ADJUSTMENT CALCULATION

N/A

MEASURE CODE: CI-HVC-SBAC-V03-230101

REVIEW DEADLINE: 1/1/2028

⁹¹⁵ “Steam Balancing and Tuning for Multifamily Residential Buildings in Chicagoland-Second Year of Data Collection”, NREL, August 2013, states that test buildings with steam balancing measures saved an average of 10.2%. The energy savings estimate assumes additional system balancing through the installation of large capacity air vents on steam main lines and the replacement of radiator vents. This work is assumed to be done in concert with any system being retrofitted with averaging controls.

4.4.37 Unitary HVAC Condensing Furnace

DESCRIPTION

Condensing furnaces recover energy in combustion exhaust flue gasses that would otherwise simply be vented to the atmosphere, making them more efficient than non-condensing furnaces. This measure applies to a constant volume (CV), dedicated outside air system (DOAS), make-up air system (MUAS), or any unitary HVAC system that is utilizing an indirect gas fired process to heat 100% OA to provide ventilation or make-up air to commercial and industrial (C&I) building spaces. The unitary package must contain an indirect gas-fired, warm air furnace section, but the unitary package can be with or without an electric air conditioning section. The unitary package can be either a single package or split system that is applied indoors (non-weatherized) or outdoors (weatherized).

This measure excludes demand control ventilation, condensing unit heaters, and high efficiency (condensing) furnaces with annual fuel utilization efficiency (AFUE) ratings (for furnaces with less than 225,000 Btu/hr input capacity), which are covered by other measures for the C&I sector in the Technical Reference Manual (TRM).⁹¹⁶

This measure was developed to be applicable to the following program types: TOS, NC. If applied to other program types, the measure savings should be verified.

DEFINITION OF EFFICIENT EQUIPMENT

To qualify for this measure, the efficient unitary equipment must contain a condensing, warm air furnace with a natural gas thermal efficiency (TE) rating of 90% or higher, or alternatively, the unitary package must have equipment nameplate information for natural gas that identifies a heating output and heating input rating that has an output over input ratio of 0.90 or higher. These ratings must be certified by a recognized testing laboratory in accordance with American National Standards Institute (ANSI) Standard Z21.47 for Gas-Fired Central Furnaces.⁹¹⁷ The furnace must be vented and condensate disposed of in accordance with the equipment manufacturer installation instructions and applicable codes.

DEFINITION OF BASELINE EQUIPMENT

The baseline equipment is expected to be unitary equipment that contains a non-condensing, warm air furnace with a natural gas thermal efficiency (TE) rating of 81%, or alternatively, the unitary package will have equipment nameplate information for natural gas that identifies a heating output and heating input rating that has an output over input ratio of 0.81. These ratings must be certified by a recognized testing laboratory in accordance with American National Standards Institute (ANSI) Standard Z21.47 for Gas-Fired Central Furnaces. Note, effective January 1, 2023, the Department of Energy (DOE) federal minimum efficiency standard is 81% for $\geq 225,000$ Btu/hr input capacity furnaces per the Energy Conservation Standard for Commercial Warm Air Furnaces.⁹¹⁸ In the American Society of Heating, Refrigeration and Air-Conditioning Engineers (ASHRAE) Standard 90.1 Energy Standard for Buildings Except Low-Rise Residential Buildings⁹¹⁹ that minimum TE requirement is extended below 225,000 Btu/hr input capacity to require all commercial warm air furnaces and combination warm air furnace/air conditioning units to meet the minimum 81% TE.

DEEMED LIFETIME OF EFFICIENT EQUIPMENT

The expected measure life is assumed to be 15 years⁹²⁰, which is consistent with the established TRM measure life for single-package and split system unitary air conditioners, since in colder climates these unitary packages typically contain a gas-fired, warm air furnace section, with an electric air conditioning section.

⁹¹⁶ Illinois Statewide Technical Reference Manual (TRM), Version 12.0 (effective January 1, 2024), 2024.

⁹¹⁷ American National Standards Institute (ANSI), ANSI Z21.47 Standard for Central Gas-Fired Central Furnaces, 2012.

⁹¹⁸ Department of Energy (DOE), Commercial Warm Air Furnace Standard DOE 10 CFR, Part 431, Subpart D – Commercial Warm Air Furnaces, (10 CFR 431.77).

⁹¹⁹ American Society of Heating, Refrigeration and Air-Conditioning Engineers (ASHRAE), ASHRAE Standard 90.1 Energy Standard for Buildings Except Low-Rise Residential Buildings, 2013.

⁹²⁰ Minnesota Department of Commerce, Division of Energy Resources, Field Study of Condensing Heating in Makeup-Air and Mixed-Air Rooftop Units (RTUs), GTI, October 2017

DEEMED MEASURE COST

The actual incremental equipment and installation costs should be used, if available. If not, the incremental cost of \$5.42 per 1000 Btu/hr of output capacity should be used for the condensing furnace equipment (as part of a unitary package) and its installation (including the combustion condensate drainage and disposal system). This incremental cost is from the DOE Technical Support Document for the Notice of Proposed Rulemaking (NOPR) for the Commercial Warm Air Furnace Standard.⁹²¹ Per the DOE documentation, it is based on their representative 250,000 Btu/hr input capacity furnace at a 92% TE.

LOADSHAPE

Loadshape C23 - Commercial Ventilation

COINCIDENCE FACTOR

The coincidence factor is assumed to be 1.0 – that is, building ventilation will always be provided during peak periods.

Algorithm

CALCULATION OF SAVINGS

The following methodology provides formulas for estimating gas heating savings associated with condensing furnaces in unitary HVAC packages when applied as a CV, DOAS, MUAS, or any RTU that is indirectly heating 100% outside air (OA). These types of HVAC systems typically run continuously during the HVAC operating schedule to provide building ventilation and maintain indoor air quality or to compensate for exhaust and maintain neutral or slightly positive building pressurization. The algorithm estimates the gas use reduction resulting from utilizing condensing heating of 90% or higher thermal efficiency (TE) in place of the federal minimum TE of 80% (or other user defined baseline TE) for commercial warm air furnaces.

The methodology provides a representative group of operating schedules for the market sector applications highlighted earlier based on DOE commercial reference building models.⁹²² Heating loads during the operating schedule are determined based on hourly differences between a range of supply air (SA) heated to temperatures and the OA temperature using Typical Meteorological Year (TMYx) weather data.⁹²³ These hourly heating loads are generated for all hours when the OA temperature is below the base temperature of 55 °F for heating in C&I settings per the TRM. To accommodate the variability in heating base temperatures in C&I settings, these hourly heating loads are also generated for base temperatures of 45 °F and 65 °F for heating. The hourly heating loads are then summed for the entire year. The annual heating loads are calculated in this manner for the climate zone 2 weather station (Chicago O’Hare Airport), which is then normalized to its National Centers for Environmental Information (NCEI)⁹²⁴ 15-year (2006-2020) weather average by multiplying by the heating degree day (HDD) ratio of the NCEI/TRM HDD55 over the TMYx HDD55 (HDD at base temperature of 55 °F), and likewise for the annual heating loads for HDD45 (HDD at base temperature of 45 °F) and HDD65 (HDD at base temperature of 65 °F), using the values in Table 1 and Table 2. Since detailed hourly weather data is not available for all 5 of the TRM climate zone weather stations, the annual heating loads for the other climate zones are determined by multiplying the climate zone 2 annual heating loads by the ratio of the other climate zone NCEI HDD over the climate zone 2 NCEI HDD, using the values in Table 1.

These annual heating loads on a per unit airflow basis are then used in conjunction with the actual airflow of the 100% OA system and its condensing efficiency to calculate the gas heating savings versus the baseline (non-condensing) heating efficiency. This measure results in additional electric use by the unitary HVAC package due to the additional pressure drop of the condensing heat exchanger of the warm air furnace section.

⁹²¹ Department of Energy (DOE), Rulemaking for Commercial Warm Air Furnace Standard, Technical Support Document 2015.

⁹²² Department of Energy (DOE) National Renewable Energy Laboratory, Commercial Reference Building Models of the National Building Stock, 2011.

⁹²³ TMYx climate normal data from year 2007 till 2021; climate.onebuilding.org.

⁹²⁴ National Centers for Environmental Information, U.S Climate Normal 15-year data set from 2006-2020.

Table 1. NCEI/TRM HDD Values for All Climate Zones

Climate Zone - Weather Station/City	NCEI 15 Year Average HDD45 ⁸	NCEI 15 Year Average HDD55 ^{1,8}	NCEI 15 Year Average HDD65 ⁸
1 - Rockford AP / Rockford	2419	4171	6414
2 - Chicago O'Hare AP / Chicago	2059	3760	5963
3 - Springfield #2 / Springfield	1743	3296	5368
4 - Belleville SIU RSCH / Belleville	1089	2351	4162
5 - Carbondale Southern IL AP / Marion	1148	2499	4413

Table 2. TMYx HDD Values for Climate Zone 2

Climate Zone - Weather Station/City	TMYx HDD45 ⁷	TMYx HDD55 ⁷	TMYx HDD65 ⁷
2 - Chicago O'Hare AP / Chicago	2093	3855	6086

ELECTRIC ENERGY SAVINGS

As noted previously, this measure results in additional SA fan electric use by the unitary HVAC system due to the additional pressure drop of the condensing heat exchanger of the warm air furnace section.

$$\Delta kWh = - (t_{FAN} * cfm * \Delta P) / (\eta_{FAN/MOTOR} * 8520)$$

Where:

t_{FAN} = annual fan runtime (hr), refer to Tables 3 through 14

cfm = airflow (cfm), use actual or rated system airflow

ΔP = incremental pressure drop (inch W.G.), assume 0.15 if actual value not known

$\eta_{FAN/MOTOR}$ = combined fan and motor efficiency, assume 0.60 if actual value not known

8520 = conversion factor (fan horsepower – HP – calculation constant of 6356 for standard air conditions adjusted by 1 HP = 0.746 kW, or 6356/ 0.746 = 8520 for this kW calculation)

SUMMER COINCIDENT PEAK DEMAND SAVINGS

The additional SA fan electric use by the unitary HVAC system will typically result in a modest electric demand increase.

$$\Delta kW = (\Delta kWh / t_{FAN}) * CF$$

Where:

$$CF = 1.0$$

For example, for a “big box” retail store operating 24 hours a day and 7 days a week (8760 hours per year) with a 5000 cfm DOAS that has an incremental pressure drop of 0.15 inch W.G. and a combined fan and motor efficiency of 0.6 has annual kWh savings of:

$$\begin{aligned} \Delta kWh &= - (t_{FAN} * cfm * \Delta P) / (\eta_{FAN/MOTOR} * 8520) \\ &= - (8760 * 5000 * 0.15) / (0.6 * 8520) \\ &= - 1285 \text{ kWh} \\ \Delta kW &= (\Delta kWh / t_{FAN}) * CF \\ &= (- 1285 / 8760) * 1.0 \\ &= - 0.15 \text{ kW} \end{aligned}$$

FOSSIL FUEL SAVINGS

$$\Delta \text{Therms} = [Q_{OA} * cfm * (1/TE_{NC} - 1/TE_c)] / 100,000$$

Where:

$$Q_{OA} = \text{annual outside air (OA) heating load per cfm of OA (Btu/cfm)}$$

First, select the most representative operating schedule for the application from among the four (4) scenarios listed below and its set of three (3) applicable tables. Second, select the table in that set with the most representative HDD base temperature – the base temperature for OA below which heating is required. If that base temperature is not readily determined, select the TRM default base temperature of 55 °F (HDD55) for heating in C&I settings. Third, select the climate zone within that table. Fourth, select an appropriate heated to supply air (SA) temperature within that table. Use the resulting Q_{OA} value, with linear interpolation allowed between SA temperatures.

The four (4) scenarios available are indicative of the following building applications and operating schedules:

1. 24 hour a day and 7 day a week (24/7) operation, with HVAC operating schedule of 8760 hours per year, typical of large retail stores with DOAS, hotel/multifamily buildings with corridor MUAS, and healthcare facilities with DOAS. Use Table 3 through Table 5.
2. 6:00 AM to 1:00 AM everyday operation, with HVAC operating schedule of 7300 hours per year, typical of full service and quick service restaurants with kitchen MUAS. Use Table 6 through Table 8.
3. 7:00 AM to 9:00 PM Monday-Friday, 7:00 AM to 10:00 PM Saturday, and 9:00 AM to 7:00 PM Sunday operations, with HVAC operating schedule of 5266 hours per year, typical of non-24/7 retail stores with DOAS. Use Table 9 through Table 11.
4. 7:00 AM to 9:00 PM Monday-Friday operation, with HVAC operating schedule of 3911 hours per year, typical of school buildings with DOAS. Use Table 12 through Table 14.

$$TE_{NC} = \text{non-condensing thermal efficiency (TE), use federal minimum TE of 81\% (0.81) or actual TE if known}$$

$$TE_c = \text{condensing thermal efficiency (TE), use actual TE or if unknown assume 90\% (0.90)}$$

100,000 = conversion factor (1 therm = 100,000 Btu)

Continuing the previous example: for a climate zone 2 (Chicago O'Hare AP / Chicago) application using a 90% TE condensing DOAS with a supply air temperature from the DOAS of 95 °F:

$$\begin{aligned} \Delta\text{Therms} &= [Q_{\text{OA}} * \text{cfm} * (1/T_{\text{ENC}} - 1/T_{\text{EC}})] / 100,000 \\ &= 307,374 * 5,000 * (1/0.81 - 1/0.90) / 100,000 \\ &= 1,897 \text{ therms} \end{aligned}$$

8760 Hour Annual Operation Scenario

Table 3. 8760 Hour Annual Operation Scenario for HDD45

Supply Air Fan Runtime = 8760 Hours	Q _{oa} (Annual Btu/cfm) At Supply Air Temperature Of			
	75°F	85°F	95°F	105°F
Climate Zone - Weather Station/City				
1 - Rockford AP / Rockford	200,876	246,935	292,995	339,054
2 - Chicago O'Hare AP / Chicago	171,021	210,235	249,449	288,663
3 - Springfield #2 / Springfield	144,713	177,895	211,076	244,258
4 - Belleville SIU RSCH / Belleville	90,394	111,120	131,847	152,574
5 - Carbondale Southern IL AP / Marion	95,368	117,235	139,102	160,970

Table 4. 8760 Hour Annual Operation Scenario for HDD55

Supply Air Fan Runtime = 8760 Hours	Q _{oa} (Annual Btu/cfm) At Supply Air Temperature Of			
	75°F	85°F	95°F	105°F
Climate Zone - Weather Station/City				
1 - Rockford AP / Rockford	229,235	285,134	341,034	396,933
2 - Chicago O'Hare AP / Chicago	206,610	256,992	307,374	357,756
3 - Springfield #2 / Springfield	181,126	225,294	269,462	313,630
4 - Belleville SIU RSCH / Belleville	129,220	160,730	192,240	223,751
5 - Carbondale Southern IL AP / Marion	137,337	170,826	204,316	237,806

Table 5. 8760 Hour Annual Operation Scenario for HDD65

Supply Air Fan Runtime = 8760 Hours	Q _{oa} (Annual Btu/cfm) At Supply Air Temperature Of			
	75°F	85°F	95°F	105°F
Climate Zone - Weather Station/City				
1 - Rockford AP / Rockford	249,288	321,098	392,909	464,719
2 - Chicago O'Hare AP / Chicago	231,766	298,529	365,292	432,055
3 - Springfield #2 / Springfield	208,624	268,721	328,818	388,914
4 - Belleville SIU RSCH / Belleville	161,761	208,358	254,955	301,553
5 - Carbondale Southern IL AP / Marion	171,517	220,924	270,332	319,739

7300 Hour Annual Operation Scenario

Table 6. 7300 Hour Annual Operation Scenario for HDD45

Supply Air Fan Runtime = 7300 Hours	Q _{oa} (Annual Btu/cfm) At Supply Air Temperature Of			
	Climate Zone -Weather Station/City	75°F	85°F	95°F
1 - Rockford AP / Rockford	170,393	207,917	245,441	282,965
2 - Chicago O'Hare AP / Chicago	145,069	177,016	208,963	240,910
3 - Springfield #2 / Springfield	122,753	149,785	176,818	203,851
4 - Belleville SIU RSCH / Belleville	76,677	93,562	110,448	127,333
5 - Carbondale Southern IL AP / Marion	80,896	98,711	116,526	134,341

Table 7. 7300 Hour Annual Operation Scenario for HDD55

Supply Air Fan Runtime = 7300 Hours	Q _{oa} (Annual Btu/cfm) At Supply Air Temperature Of			
	Climate Zone -Weather Station/City	75°F	85°F	95°F
1 - Rockford AP / Rockford	184,019	229,029	274,038	319,047
2 - Chicago O'Hare AP / Chicago	165,857	206,423	246,990	287,557
3 - Springfield #2 / Springfield	145,400	180,963	216,526	252,090
4 - Belleville SIU RSCH / Belleville	103,732	129,103	154,475	179,847
5 - Carbondale Southern IL AP / Marion	110,248	137,213	164,178	191,144

Table 8. 7300 Hour Annual Operation Scenario for HDD65

Supply Air Fan Runtime = 7300 Hours	Q _{oa} (Annual Btu/cfm) At Supply Air Temperature Of			
	Climate Zone -Weather Station/City	75°F	85°F	95°F
1 - Rockford AP / Rockford	199,927	257,510	315,093	372,675
2 - Chicago O'Hare AP / Chicago	185,875	239,410	292,946	346,481
3 - Springfield #2 / Springfield	167,315	215,505	263,695	311,885
4 - Belleville SIU RSCH / Belleville	129,731	167,096	204,461	241,826
5 - Carbondale Southern IL AP / Marion	137,555	177,174	216,792	256,411

5266 Hour Annual Operation Scenario

Table 9. 5266 Hour Annual Operation Scenario for HDD45

Supply Air Fan Runtime = 5266 Hours	Q _{oa} (Annual Btu/cfm) At Supply Air Temperature Of			
	Climate Zone -Weather Station/City	75°F	85°F	95°F
1 - Rockford AP / Rockford	116,847	142,840	168,834	194,827
2 - Chicago O'Hare AP / Chicago	99,481	121,611	143,742	165,872
3 - Springfield #2 / Springfield	84,178	102,904	121,630	140,355
4 - Belleville SIU RSCH / Belleville	52,581	64,278	75,975	87,672
5 - Carbondale Southern IL AP / Marion	55,474	67,815	80,156	92,496

Table 10. 5266 Hour Annual Operation Scenario for HDD55

Supply Air Fan Runtime = 5266 Hours	Q _{oa} (Annual Btu/cfm) At Supply Air Temperature Of			
	Climate Zone -Weather Station/City	75°F	85°F	95°F
1 - Rockford AP / Rockford	125,486	156,333	187,181	218,028

Supply Air Fan Runtime = 5266 Hours	Q _{oa} (Annual Btu/cfm) At Supply Air Temperature Of			
2 - Chicago O'Hare AP / Chicago	113,100	140,903	168,706	196,509
3 - Springfield #2 / Springfield	99,150	123,524	147,897	172,271
4 - Belleville SIU RSCH / Belleville	70,736	88,125	105,513	122,902
5 - Carbondale Southern IL AP / Marion	75,180	93,660	112,141	130,622

Table 11. 5266 Hour Annual Operation Scenario for HDD65

Supply Air Fan Runtime = 5266 Hours	Q _{oa} (Annual Btu/cfm) At Supply Air Temperature Of			
Climate Zone -Weather Station/City	75°F	85°F	95°F	105°F
1 - Rockford AP / Rockford	136,447	175,864	215,281	254,697
2 - Chicago O'Hare AP / Chicago	126,857	163,503	200,149	236,795
3 - Springfield #2 / Springfield	114,190	147,177	180,164	213,151
4 - Belleville SIU RSCH / Belleville	88,540	114,117	139,694	165,271
5 - Carbondale Southern IL AP / Marion	93,880	120,999	148,119	175,239

3911 Hour Annual Operation Scenario

Table 12. 3911 Hour Annual Operation Scenario for HDD45

Supply Air Fan Runtime = 3911 Hours	Q _{oa} (Annual Btu/cfm) At Supply Air Temperature Of			
Climate Zone -Weather Station/City	75°F	85°F	95°F	105°F
1 - Rockford AP / Rockford	84,156	102,887	121,617	140,348
2 - Chicago O'Hare AP / Chicago	71,649	87,596	103,542	119,489
3 - Springfield #2 / Springfield	60,627	74,121	87,614	101,108
4 - Belleville SIU RSCH / Belleville	37,870	46,299	54,728	63,156
5 - Carbondale Southern IL AP / Marion	39,954	48,847	57,739	66,632

Table 13. 3911 Hour Annual Operation Scenario for HDD55

Supply Air Fan Runtime = 3911 Hours	Q _{oa} (Annual Btu/cfm) At Supply Air Temperature Of			
Climate Zone -Weather Station/City	75°F	85°F	95°F	105°F
1 - Rockford AP / Rockford	90,860	113,295	135,729	158,164
2 - Chicago O'Hare AP / Chicago	81,892	102,113	122,333	142,553
3 - Springfield #2 / Springfield	71,792	89,518	107,244	124,970
4 - Belleville SIU RSCH / Belleville	51,218	63,864	76,510	89,157
5 - Carbondale Southern IL AP / Marion	54,435	67,876	81,317	94,757

Table 14. 3911 Hour Annual Operation Scenario for HDD65

Supply Air Fan Runtime = 3911 Hours	Q _{oa} (Annual Btu/cfm) At Supply Air Temperature Of			
Climate Zone -Weather Station/City	75°F	85°F	95°F	105°F
1 - Rockford AP / Rockford	99,503	128,516	157,530	186,543
2 - Chicago O'Hare AP / Chicago	92,509	119,483	146,457	173,431
3 - Springfield #2 / Springfield	83,272	107,553	131,834	156,114
4 - Belleville SIU RSCH / Belleville	64,567	83,393	102,220	121,046

Supply Air Fan Runtime = 3911 Hours	Q _{oa} (Annual Btu/cfm) At Supply Air Temperature Of			
	75°F	85°F	95°F	105°F
Climate Zone -Weather Station/City				
5 - Carbondale Southern IL AP / Marion	68,461	88,423	108,385	128,347

WATER IMPACT DESCRIPTIONS AND CALCULATION

N/A

DEEMED O&M COST ADJUSTMENT CALCULATION

The actual incremental annual maintenance costs should be used, if available. If not, the incremental cost of \$0.05 per 1000 Btu/hr of output capacity should be used for maintaining the combustion condensate disposal system yearly. This incremental cost is from the DOE Technical Support Document for the Notice of Proposed Rulemaking (NOPR) for the Commercial Warm Air Furnace Standard. Per the DOE documentation, it is based on their representative 250,000 Btu/hr input capacity furnace at a 92% TE.

MEASURE CODE: CI-HVC-DSFN-V05-240101

REVIEW DEADLINE: 1/1/2027

4.4.38 Covers and Gap Sealers for Room Air Conditioners

DESCRIPTION

Room air conditioners (window ACs, through-the-wall or sleeve ACs, PTACs or PTHPs) constitute a permanent or semi-permanent penetration through the building's envelope. These units are often poorly installed, resulting in gaps that act like air leakage pathways through the building's envelope. The uncontrolled movement of air across the gaps in the envelope (infiltration) increases the building's winter heating requirements and reduces its overall energy performance.

The heat loss and infiltration can be reduced by installing a rigid or flexible insulated cover on the inside of a room AC. These covers should be maintained by building staff and should remain installed through the heating season. Simple uninsulated cloth covers with no sealing at edges do not qualify for this measure.

There are several types of AC covers available that may be eligible for this measure:

- If the room AC is left in the window or sleeve, a rigid cover that covers the indoor side of the AC unit with foam gaskets to seal the edges may be installed.
- If the room AC is absent or is removed during the heating months, a rigid cover that fits inside the sleeve with foam gaskets along the edges for proper air sealing may be installed.
- Flexible covers that are well insulated and perfectly cover the indoor side of the AC unit may also be eligible for this measure.

This measure was developed to be applicable to the following program types: RF, DI. If applied to other program types, the measure savings should be verified.

DEFINITION OF EFFICIENT EQUIPMENT

The installed equipment is a rigid cover that fits inside the empty sleeve or completely covers the indoor side of a window AC unit, with foam gaskets sealing the edges. A flexible insulated cover that perfectly covers the indoor side of the unit and seals gaps may also be installed. Covers should remain installed throughout the winter heating season.

DEFINITION OF BASELINE EQUIPMENT

The baseline equipment is a room AC (window AC, through-the-wall or sleeve AC, PTAC or PTHP) that is poorly installed with gaps around the edges and does not use AC covers or gap sealers during the winter heating months.

DEEMED LIFETIME OF EFFICIENT EQUIPMENT

The estimated useful life of typical AC covers is 5 years.⁹²⁵

DEEMED MEASURE COST

The measure cost is the full cost of installing AC covers. Actual installation costs (material and labor) should be used if available. In actual costs are unknown, assume material cost of \$24 (flexible covers) up to \$119, depending on size of the AC unit.⁹²⁶ The install time per unit is 15 to 30 minutes at assumed labor rate of \$20/hour.

LOADSHAPE

Loadshape C04 – Commercial Electric Heating

COINCIDENCE FACTOR

N/A

⁹²⁵ New York Standard Approach for Estimating Energy Savings from Energy Efficiency Programs V4, April 2016 (New York TRM).

⁹²⁶ Cost estimates from customer invoices and vendors. Material costs can be lower for bulk orders.

Algorithm

CALCULATION OF ENERGY SAVINGS

ELECTRIC ENERGY SAVINGS

If the building is electrically heated, electric energy savings are calculated as follows:

$$\Delta kWh = (Q_{infiltration} * 1.08 * (T_{SA} - T_{OA}) * EFLH_{heat}) / (3,412 * COP)$$

Where:

$$Q_{infiltration} = \text{Air infiltration (CFM) due to poor installation of window or through-the-wall AC}^{927}$$

$$= ELA * 0.000645 * (f_s^2 * (T_{SA} - T_{OA}) + f_w^2 * U^2)^{1/2} * 2118.88$$

Where:

ELA = Effective Leakage Area (sq. in.)
 = Can be collected on site; if unknown, assume 6 sq. in.⁹²⁸

0.000645 = Converts square inches to square meters

f_s = Stack Coefficient
 = $1/3 * (9.81 * \text{Height} * 0.3048 / T_{OA})^{0.5}$

f_w = Wind Coefficient
 = $A * B * (\text{Height} * 0.3048 / 10)^C$

Where:

9.81 = Acceleration due to gravity (m/s²)

Height = Height of the location of the leakage area in feet
 = Assume 8 ft per floor

0.3048 = Converts feet to meters

T_{OA} = Average Outside Air Temperature during heating period.⁹²⁹
 Use values from table below, based on facility location.⁹³⁰ This figure must be in Kelvin to determine Stack Coefficient (f_s) and infiltration ($Q_{infiltration}$), but in Fahrenheit to determine energy savings (ΔkWh , $\Delta Therms$).

Zone	T_{OA} (°F)	T_{OA} (K)
Zone 1 (Rockford)	31.63	272.94
Zone 2 (Chicago)	33.99	274.26
Zone 3 (Springfield)	34.58	274.58
Zone 4 (Belleville)	36.24	275.51
Zone 5 (Marion)	39.07	277.08

⁹²⁷ Infiltration equation and values for stack and wind coefficient equations from “The Use of Blower Door Data.” Max Sherman, 1998. The equation is adjusted for wall leakage area (i.e. no ceiling or floor leakage).

⁹²⁸ Average effective leakage area for multi-family building AC units from “There are Holes in Our Walls.” Prepared for Urban Green Council by Steven Winter Associates, April 2011.

⁹²⁹ “Heating Period” is defined as hours when the TMY3 dry bulb temperature is less than 55°F (balance point).

⁹³⁰ Based on NREL’s Typical Meteorological Year 3 (TMY3) data for different weather stations.

A, B and C = Constants based on the facility site’s shielding and terrain parameters. Use values from the tables below:⁹³¹

Shielding Class	Shielding Type	Shielding Description	A
1	None	No obstructions or local shielding whatsoever (i.e. isolated building)	0.324
2	Light	Light local shielding with few obstructions (e.g. A few trees or a shed in the vicinity)	0.285
3	Moderate	Moderate local shielding; some obstructions within two house heights (e.g. Thick hedge fence on fence and nearby building)	0.24
4	Heavy	Heavy shielding; obstructions around most of perimeter buildings or trees within five building heights in most directions (e.g. Well developed/dense tract house)	0.185
5	Very Heavy	Very heavy shielding, large obstruction surrounding perimeter within two house heights (e.g. Typical downtown area)	0.102

Terrain Class	Terrain Type	Terrain Description	B	C
1	None	Ocean or other body of water with at least 5 km of unrestricted space	1.3	0.1
2	Light	Flat terrain with some isolated obstacles (e.g. Buildings or trees well separated from each other)	1	0.15
3	Moderate	Rural areas with low buildings, trees etc.	0.85	0.2
4	Heavy	Urban, industrial or forest areas	0.67	0.25
5	Very Heavy	Center of large city (e.g. Manhattan)	0.47	0.35

0.3048 = Converts feet to meters

T_{SA} = Average Indoor Air Temperature during heating period. This figure will need to be in Kelvin to calculate infiltration ($Q_{infiltration}$) and Fahrenheit to calculate energy savings (ΔkWh , $\Delta Therms$).

= Collected on site. If unknown, assume 72°F (295 K). If known, convert °F to K by using the following equation: $K = (°F + 459.67) * (5/9)$.

U = Average Wind Speed (m/s) during heating period. Use table below, based on facility location.⁹³²

Zone	U (m/s)
Zone 1 (Rockford)	4.50
Zone 2 (Chicago)	4.67
Zone 3 (Springfield)	4.60
Zone 4 (Belleville)	3.92
Zone 5 (Marion)	3.07

2118.88 = Converts m^3/s to CFM

1.08 = Sensible heat transfer constant (Btu/hr.CFM.°F)

⁹³¹ Shielding and terrain class descriptions and constants from “The Use of Blower Door Data.” Max Sherman, 1998” and “Wind and Infiltration Interaction for Small Buildings.” MH Sherman and DT Grimsrud, Lawrence Berkley Laboratory, 1982.

⁹³² Based on TMY3 data, see “Covers for Room AC_11092016.xls” for more information.

- EFLH_{heat} = Equivalent Full Load Hours for heating in Existing Buildings from section 4.4 HVAC End Use⁹³³
- 3,412 = Converts Btus to kWh
- COP = Coefficient of Performance of the heating unit
= Collected on site. If unknown assume 2.6 for PTHP⁹³⁴

If the floor of the building where the AC cover was installed is known, deemed per-unit savings for the Multifamily Building type for Shielding Class 3 and Terrain Class 3 are as follows:

Multifamily - Electric Savings per Unit (kWh/unit)						
Floor # Where Installed is Known						
Floor # Where Installed	Height	Rockford	Chicago	Springfield	Belleville	Marion
1	8	55.18	53.16	45.70	31.09	25.67
2	16	68.19	65.31	56.17	38.72	32.66
3	24	77.92	74.34	63.96	44.45	37.97
4	32	86.04	81.85	70.44	49.25	42.44
5	40	93.15	88.42	76.11	53.46	46.37
6	48	99.56	94.34	81.22	57.26	49.93
7	56	105.44	99.76	85.90	60.75	53.20
8	64	110.91	104.80	90.25	63.99	56.24
9	72	116.04	109.53	94.33	67.04	59.11
10	80	120.89	114.00	98.19	69.92	61.81
12	96	129.92	122.31	105.36	75.29	66.85
14	112	138.21	129.94	111.95	80.22	71.49
16	128	145.93	137.04	118.08	84.81	75.82
18	144	153.19	143.72	123.84	89.13	79.88
20	160	160.05	150.03	129.29	93.21	83.72
22	176	166.59	156.03	134.47	97.10	87.38
24	192	172.83	161.77	139.42	100.82	90.88
26	208	178.82	167.28	144.18	104.38	94.23
28	224	184.58	172.57	148.75	107.81	97.46
30	240	190.15	177.69	153.17	111.12	100.58

If the floor of the building where the AC cover was installed is unknown, but the total number of floors in the building is known, assume the AC covers were installed evenly across all floors of the building. Therefore, savings is the average of the savings for each floor less than or equal to the total number of floors in the building. The deemed per-unit savings for the Multifamily Building type for Shielding Class 3 and Terrain Class 3 is:

Multifamily - Electric Savings per Unit (kWh/unit)						
Floor # Where Installed is not Known, But Total Building Height is Known						
# of Floors in Building	Building Height	Rockford	Chicago	Springfield	Belleville	Marion
1	8	55.18	53.16	45.70	31.09	25.67
2	16	61.69	59.24	50.94	34.91	29.17

⁹³³ Although in theory the hours should be all hours that infiltration is expected (i.e. all hours <55F), the IL TAC has agreed to use the Equivalent Full Load Hours to keep the savings at a more conservative level.

⁹³⁴ From IECC 2012 Minimum Efficiency Requirements. For a 1 ton PTHP, COP = 2.9 – (0.026 * 12,000/1,000).

Multifamily - Electric Savings per Unit (kWh/unit)						
Floor # Where Installed is not Known, But Total Building Height is Known						
# of Floors in Building	Building Height	Rockford	Chicago	Springfield	Belleville	Marion
3	24	67.10	64.27	55.28	38.09	32.10
4	32	71.83	68.67	59.07	40.88	34.69
5	40	76.10	72.62	62.48	43.39	37.02
6	48	80.01	76.24	65.60	45.71	39.17
7	56	83.64	79.60	68.50	47.85	41.18
8	64	87.05	82.75	71.22	49.87	43.06
9	72	90.27	85.72	73.79	51.78	44.84
10	80	93.33	88.55	76.23	53.59	46.54
12	96	96.66	91.62	78.88	55.57	48.39
14	112	100.12	94.81	81.63	57.62	50.31
16	128	103.64	98.06	84.44	59.71	52.27
18	144	107.18	101.32	87.25	61.81	54.25
20	160	110.71	104.57	90.05	63.91	56.21
22	176	114.20	107.79	92.83	65.98	58.16
24	192	117.65	110.96	95.57	68.03	60.08
26	208	121.05	114.09	98.27	70.05	61.98
28	224	124.39	117.17	100.93	72.04	63.85
30	240	127.68	120.19	103.54	73.99	65.68

For example, a mid-rise multi-family building located in the moderate terrain class and shielding class of Chicago, has 16 rooms on the 10th floor (80 feet high) with PTHPs that get covered with a cover and foam gasket during the heating months. The indoor temperature during the heating months is maintained at 74°F. The air infiltration and the related energy savings from the AC covers and seals are calculated as follows -

For Shielding Class 3 and Terrain Class 3,

A = 0.24, B = 0.85 and C = 0.2

Therefore,

$$f_s = 1/3 * (9.81 \text{ m/s}^2 * 80 \text{ ft} * 0.3048 \text{ m/ft} / 274.26 \text{ K})^{0.5} = 0.3 \text{ m/K}^{1/2} \cdot \text{s}$$

$$f_w = 0.24 * 0.85 * (80 \text{ ft} * 0.3048 \text{ m/ft} / 10 \text{ m})^{0.2} = 0.24$$

Total effective leakage area (ELA) = 16 units * 6 sq. in. = 96 sq. in.

$$Q_{\text{infiltration}} = \text{ELA} * 0.000645 * (f_s^2 * (T_{SA} - T_{OA}) + f_w^2 * U^2)^{1/2} * 2118.88$$

$$= 96 * 0.000645 * (0.3^2 * (296.48 \text{ K} - 274.26 \text{ K}) + 0.24^2 * 4.67^2)^{1/2} * 2118.88$$

$$= 237 \text{ CFM}$$

$$\Delta \text{kWh} = (237 * 1.08 \text{ Btu/hr.CFM.}^\circ\text{F} * (74^\circ\text{F} - 33.99^\circ\text{F}) * 1,782) / (3,412 \text{ Btu/kWh} * 2.6)$$

$$= 2,057 \text{ kWh}$$

SUMMER COINCIDENT PEAK DEMAND SAVINGS

As the savings occur during the winter season (non-peak), there are no demand savings associated with this measure.

FOSSIL FUEL SAVINGS

If the building is heated with gas, the natural gas savings are calculated as follows:

$$\Delta \text{Therms} = (Q_{\text{infiltration}} * 1.08 \text{ Btu/hr.CFM.}^\circ\text{F} * (T_{SA} - T_{OA}) * \text{EFLH}_{\text{heat}}) / (100,000 \text{ Btu/therm} * \eta)$$

Where:

η = Efficiency of heating equipment.
 = Collected on site. If unknown, assume 80%⁹³⁵.

100,000 = Converts Btus to therms

Other factors as defined above

If the floor of the building where the AC cover was installed is known, deemed per-unit savings per unit for the Multifamily Building type for Shielding Class 3 and Terrain Class 3 are as follows:

Multifamily - Gas Savings per Unit (Therms/Unit) Floor # Where Installed is Known						
Floor # Where Installed	Height	Rockford	Chicago	Springfield	Belleville	Marion
1	8	6.12	5.90	5.07	3.45	2.85
2	16	7.56	7.24	6.23	4.29	3.62
3	24	8.64	8.24	7.09	4.93	4.21
4	32	9.54	9.08	7.81	5.46	4.71
5	40	10.33	9.81	8.44	5.93	5.14
6	48	11.04	10.46	9.01	6.35	5.54
7	56	11.69	11.06	9.53	6.74	5.90
8	64	12.30	11.62	10.01	7.10	6.24
9	72	12.87	12.15	10.46	7.43	6.55
10	80	13.41	12.64	10.89	7.75	6.85
12	96	14.41	13.56	11.68	8.35	7.41
14	112	15.33	14.41	12.41	8.90	7.93
16	128	16.18	15.20	13.09	9.40	8.41
18	144	16.99	15.94	13.73	9.88	8.86
20	160	17.75	16.64	14.34	10.34	9.28
22	176	18.47	17.30	14.91	10.77	9.69
24	192	19.16	17.94	15.46	11.18	10.08
26	208	19.83	18.55	15.99	11.57	10.45
28	224	20.47	19.14	16.50	11.96	10.81
30	240	21.09	19.70	16.98	12.32	11.15

If the floor of the building where the AC cover was installed is unknown, but the total number of floors in the building is known, assume the AC covers were installed evenly across all floors of the building. Therefore, savings is the average of the savings for each floor less than or equal to the total number of floors in the building. The deemed per-unit savings for the Multifamily Building type for Shielding Class 3 and Terrain Class 3 is:

Multifamily - Gas Savings per Unit (Therms/Unit) Floor # Where Installed is not Known, But Total Building Height is Known						
# of Floors in Building	Building Height	Rockford	Chicago	Springfield	Belleville	Marion
1	8	6.12	5.90	5.07	3.45	2.85
2	16	6.84	6.57	5.65	3.87	3.24
3	24	7.44	7.13	6.13	4.22	3.56

⁹³⁵ Energy Independence and Security Act of 2007 – averaged for hot water and steam boilers.

Multifamily - Gas Savings per Unit (Therms/Unit)						
Floor # Where Installed is not Known, But Total Building Height is Known						
# of Floors in Building	Building Height	Rockford	Chicago	Springfield	Belleville	Marion
4	32	7.97	7.62	6.55	4.53	3.85
5	40	8.44	8.05	6.93	4.81	4.11
6	48	8.87	8.46	7.28	5.07	4.35
7	56	9.27	8.83	7.60	5.31	4.57
8	64	9.65	9.18	7.90	5.53	4.78
9	72	10.01	9.51	8.18	5.74	4.97
10	80	10.35	9.82	8.45	5.94	5.16
12	96	10.72	10.16	8.75	6.16	5.37
14	112	11.10	10.51	9.05	6.39	5.58
16	128	11.49	10.87	9.36	6.62	5.80
18	144	11.89	11.24	9.68	6.85	6.02
20	160	12.28	11.60	9.99	7.09	6.23
22	176	12.66	11.95	10.29	7.32	6.45
24	192	13.05	12.31	10.60	7.54	6.66
26	208	13.42	12.65	10.90	7.77	6.87
28	224	13.79	12.99	11.19	7.99	7.08
30	240	14.16	13.33	11.48	8.21	7.28

For example, a gas-heated mid-rise multi-family building located in the moderate terrain class and shielding class of Chicago, has 16 rooms on the 10th floor (80 feet high) with room air conditioners that get covered with an AC cover and foam gasket during the heating months. The indoor temperature during the heating months is maintained at 74°F. The air infiltration and the related therm savings from the AC covers and seals are calculated as follows:

For Shielding Class 3 and Terrain Class 3,

A = 0.24, B = 0.85 and C = 0.2

Therefore,

$$f_s = 1/3 * (9.81 \text{ m/s}^2 * 80 \text{ ft} * 0.3048 \text{ m/ft} / 274.26 \text{ K})^{0.5} = 0.3 \text{ m/K}^{1/2} \cdot \text{s}$$

$$f_w = 0.24 * 0.85 * (80 \text{ ft} * 0.3048 \text{ m/ft} / 10 \text{ m})^{0.2} = 0.24$$

Total effective leakage area (ELA) = 16 units * 6 sq.in = 96 sq. in

$$Q_{\text{infiltration}} = \text{ELA} * 0.000645 * (f_s^2 * (T_{SA} - T_{OA}) + f_w^2 * U^2)^{1/2} * 2118.88$$

$$= 96 * 0.000645 * (0.3^2 * (296.48 \text{ K} - 274.26 \text{ K}) + 0.24^2 * 4.67^2)^{1/2} * 2118.88$$

$$= 237 \text{ CFM}$$

$$\Delta \text{Therms} = (237 * 1.08 \text{ Btu/hr.CFM.}^\circ\text{F} * (74^\circ\text{F} - 33.99^\circ\text{F}) * 1,782) / (100,000 \text{ Btu/therm} * 80\%)$$

$$= 228 \text{ therms}$$

WATER AND OTHER NON-ENERGY IMPACT DESCRIPTIONS AND CALCULATION

N/A

DEEMED O&M COST ADJUSTMENT CALCULATION

N/A

MEASURE CODE: CI-HVC-CRAC-V04-250101

REVIEW DEADLINE: 1/1/2028

4.4.39 High Temperature Heating and Ventilation (HTHV) Direct Fired Heater

DESCRIPTION

This measure applies to 100% outside air, high temperature heating and ventilation (HTHV) direct fired gas heaters. These units replace unit heaters (indirect gas fired or steam coil) or rooftop units in warehouses which suffer from extreme temperature stratification, minimal controls, and reduced heating efficiencies.

Warehouses have high ceilings (~30 ft high) and suffer from stratification of air. The warm air rises and remains near the roof which keeps the thermostat from reaching its desired setpoint. This increases the run hours of the heating unit and causes discomfort among the occupants. The HTHV units have high pressure fans that direct high temperature and high velocity air towards the floor to help minimize temperature stratification. On average, a 30 ft high warehouse could reduce its linear stratification from 0.53°F/ft to 0.13°F/ft, thus maintaining a more uniform temperature in the room and reducing the operating hours of the heating unit.

Since the HTHV units are direct fired, they also have improved efficiencies of 92% compared to 80% for a typical indirect fired unit heater or rooftop unit. They transfer the latent heat of the flue gases into the space instead of venting it out.

This measure only applies to high ceiling warehouses that do not have any other destratification technologies installed (e.g., destratification fans, air rotation units). New HTHV units must be the warehouse's primary heat source.

This measure was developed to be applicable to the following program types: RF, TOS, NC. If applied to other program types, the measure savings should be verified.

DEFINITION OF EFFICIENT EQUIPMENT

The efficient equipment must be a 100% outside air, HTHV direct fired gas heater with a discharge temperature greater than or equal to 150°F, a temperature rise that is greater than or equal to 140°F, and an efficiency exceeding 92%.

DEFINITION OF BASELINE EQUIPMENT

The baseline equipment must be an indirect fired gas, steam unit heater, or a rooftop unit used as the primary space heating source. Warehouses with existing destratification technologies (high volume, low speed fans or air turnover units) do not qualify for this measure.

DEEMED LIFETIME OF EFFICIENT EQUIPMENT

The measure life is assumed to be 15 years.⁹³⁶

DEEMED MEASURE COST

The measure cost should be based on a contractor's evaluation of the project scope and may vary significantly on a project-to-project basis. If unknown, for early replacement or retrofit projects, assume \$14.50/MBtuh (material cost for an HTHV unit) or \$26/MBtuh (sum of material and installation cost).⁹³⁷

The incremental measure cost, assuming a baseline of standard efficiency unit heaters, is \$7.43/MBtuh (material cost).⁹³⁸

LOADSHAPE

Loadshape C04: Commercial Electric Heating

⁹³⁶ Based on "Field Demonstration of High Efficiency Gas Heaters", prepared for Better Buildings Alliance, US. DOE, Jim Young, Navigant Consulting, 2014.

⁹³⁷ Average costs from CLEAResult's evaluation of 9 different projects in the Chicagoland area.

⁹³⁸ Based on data collected in "Field Demonstration of High Efficiency Gas Heaters", prepared for Better Buildings Alliance, US. DOE, Jim Young, Navigant Consulting, 2014.

COINCIDENCE FACTOR

Assumed to be 0.

Algorithm

CALCULATION OF ENERGY SAVINGS

ELECTRIC ENERGY SAVINGS

HTHV units may increase the facility’s electric energy consumption due to high pressure motors that supply air at higher velocity.

$$\Delta kWh = - (kWh/HDD) * HDD$$

Where:

kWh/HDD = increase in electric energy consumption due to HTHV fan motor
 = 1.04⁹³⁹

HDD = heating degree days

Zone	City	HDD55 ⁹⁴⁰	ΔkWh
1	Rockford	4,272	(4,443)
2	Chicago	4,029	(4,190)
3	Springfield	3,406	(3,542)
4	Belleville	2,515	(2,616)
5	Marion	2,546	(2,648)

Although HTHV fan motors have a higher power draw, they also result in decreased heating equipment operating time, potentially offsetting some of the increase in electrical energy consumption. Therefore, if replacing heating equipment other than unit heaters, a custom evaluation may be necessary to determine if there is an increase in electrical energy consumption.

SUMMER COINCIDENT PEAK DEMAND SAVINGS

Since HTHV units operate during the winter (non-peak) season, there are no demand savings associated with this measure.

FOSSIL FUEL SAVINGS

Custom calculation below. Otherwise, use a deemed savings factor from the table that follows.

$$\Delta Therms = (FLH_{base} * Cap_{base} / (\eta_{base} * 100)) - (FLH_{eff} * Cap_{eff} / (\eta_{eff} * 100))$$

Where:

FLH_{base} = LF_{base} * Hours

FLH_{eff} = LF_{eff} * Hours

Hours = Annual operating hours of the unit, calculated as total number of hours when outside air temperature is less than 55°F. This can be adjusted based on the facility’s occupancy schedule.

⁹³⁹ Based on data collected in “Field Demonstration of High Efficiency Gas Heaters”, prepared for Better Buildings Alliance, US. DOE, Jim Young, Navigant Consulting, 2014. This study replaced four standard unit heaters with HTHV units, and the electrical energy increased from 0.40 kWh/HDD to 1.44 kWh/HDD. Therefore, savings are assumed to be 1.04 kWh /HDD.

⁹⁴⁰ 30-year normals from the National Climactic Data Center (NCDC), assuming base temperature 55.

LF_{base} = load factor of baseline unit heater
 $= (Q_{inf,base} + Q_{w,base} + Q_{r,base}) / (Cap_{base} * 100)$

LF_{eff} = load factor of HTHV heater
 $= (Q_{inf,eff} + Q_{w,eff} + Q_{r,eff}) / (Cap_{eff} * 100)$

Cap_{base} = existing heating unit input capacity (MBtuh)
= can be collected on site, or assumed to be the same as HTHV unit capacity, Cap_{eff}

Cap_{eff} = HTHV unit input capacity (MBtuh)
= can be collected on site or from specification sheets

η_{base} = efficiency of existing heating unit
= collected from equipment nameplate or assumed as 70% for steam unit heaters, 80% for gas fired unit heaters, and 84% for rooftop units⁹⁴¹

η_{eff} = efficiency of HTHV unit
= collected from equipment nameplate or assumed as 92%

100 = converts MBtu to therms

See following table for savings inputs.

⁹⁴¹ Efficiency of existing systems assumed from ASHRAE 90.1 – 2010 and manufacturer’s specification sheets for various equipment. Steam unit heaters have a lower efficiency due to steam distribution losses.

Parameter	Existing Unit	Proposed (Efficient) Unit
Temperatures		
Setpoint Temperature (°F):	T_{setpoint} = collected on site, or assumed as 65°F	
Ceiling Temperature ⁹⁴² (°F):	Either collected on site when the existing unit is in operation with an infrared gun or assumed as: $T_{\text{c,base}} = T_{\text{setpoint}} + 0.53^{\circ}\text{F}/\text{ft} * \text{Height}$	Either collected on site when the proposed unit is in operation with an infrared gun or assumed as: $T_{\text{c,eff}} = T_{\text{setpoint}} + 2 \text{ to } 4^{\circ}\text{F}$
Average Room Temperature (°F):	$T_{\text{r,base}} = (T_{\text{setpoint}} + T_{\text{c,base}}) / 2$	$T_{\text{r,eff}} = (T_{\text{setpoint}} + T_{\text{c,eff}}) / 2$
Outside Air Temperature (°F):	T_{OA} from local weather data ⁹⁴³	
Heat Loads		
Infiltration Load ⁹⁴⁴ :	$Q_{\text{inf,base}} = 0.04\text{CFM}/\text{ft}^2 * (\text{Wall Surface Area} + \text{Roof Surface Area}) * 1.08 * (T_{\text{r,base}} - T_{\text{OA}})$	$Q_{\text{inf,eff}} = 0.04\text{CFM}/\text{ft}^2 * (\text{Wall Surface Area} + \text{Roof Surface Area}) * 1.08 * (T_{\text{r,eff}} - T_{\text{OA}})$
Wall Conduction Load ⁹⁴⁵ :	$Q_{\text{w,base}} = 1/\text{R-value}_{\text{wall}} * (\text{Wall Surface Area} * 1.08 * (T_{\text{r,base}} - T_{\text{OA}}))$ Where: R-value _{wall} = the insulation value of the wall. It can be collected on site or assumed as R-15.	$Q_{\text{w,eff}} = 1/\text{R-value}_{\text{wall}} * (\text{Wall Surface Area} * 1.08 * (T_{\text{r,eff}} - T_{\text{OA}}))$ Where: R-value _{wall} = the insulation value of the wall. It can be collected on site or assumed as R-15.
Roof Conduction Load:	$Q_{\text{r,base}} = 1/\text{R-value}_{\text{roof}} * (\text{Roof Surface Area} * 1.08 * (T_{\text{r,base}} - T_{\text{OA}}))$ Where: R-value _{roof} = the insulation value of the roof. It can be collected on site or assumed as R-20.	$Q_{\text{r,eff}} = 1/\text{R-value}_{\text{roof}} * (\text{Roof Surface Area} * 1.08 * (T_{\text{r,eff}} - T_{\text{OA}}))$ Where: R-value _{roof} = the insulation value of the roof. It can be collected on site or assumed as R-20.
Surface Areas		
Roof Surface Area:	Collected on site or assumed as: = facility area in ft ² If facility area is unknown, assume facility area ⁹⁴⁶ : = 41.4 ft ² /MBtuh * Cap _{eff}	
Wall Surface Area:	Collected on site or assumed as: = (Height * Length + Height * Width) * 2 Where: Length, height, and width (feet) of the facility can be collected on site. If unknown, assume: Length = Width = (Facility Area) ^{1/2} and Height = 25 ft If facility area is unknown, assume facility area: = 41.4 ft ² /MBtuh * Cap _{eff}	

The default values from the table above were used to calculate the deemed savings values in the following table. Savings are provided for various rated input capacity ranges and weather stations.

⁹⁴² Baseline stratification rate is based on data collected in “Field Demonstration of High Efficiency Gas Heaters”, prepared for Better Buildings Alliance, US. DOE, Jim Young, Navigant Consulting, 2014. The study also verifies that the proposed ceiling temperature can be maintained within 2-4°F of the setpoint.

⁹⁴³ Use Typical Meteorological Year (TMY3) data from NREL.

⁹⁴⁴ Typical infiltration rate assumed from Infiltration Modeling Guidelines for Commercial Building Energy Analysis, prepared for US. DOE by Pacific Northwestern National Laboratory, 2009.

⁹⁴⁵ Roof and Wall Insulation R-values are based on ASHRAE 90.1- 2010. (Jim Young 2014) (K. Gowri 2009).

⁹⁴⁶ Based on DOE’s Commercial Prototype Modeled Warehouse building (in Chicago), via the Building Energy Codes Program.

Illinois Statewide Technical Reference Manual – 4.4.39 High Temperature Heating and Ventilation (HTHV) Direct Fired Heater

Cap _{eff} (MBtu/hr)	Average Cap _{eff} (MBtu/hr)	Nearest Weather Station	ΔTherms (Baseline: Steam Fired Unit Heaters)	ΔTherms (Baseline: Gas Fired Unit Heaters)	ΔTherms (Baseline: Rooftop Units)
300 < Cap _{eff} ≤ 500	400	Rockford	3,120	1,996	1,620
500 < Cap _{eff} ≤ 900	757	Rockford	5,208	3,346	2,725
900 < Cap _{eff} ≤ 1,000	950	Rockford	6,280	4,047	3,297
1,000 < Cap _{eff} ≤ 1,400	1,200	Rockford	7,656	4,932	4,020
1,400 < Cap _{eff} ≤ 1,600	1,499	Rockford	9,249	5,966	4,872
1,600 < Cap _{eff} ≤ 2,100	1,850	Rockford	11,100	7,160	5,865
2,100 < Cap _{eff} ≤ 2,400	2,200	Rockford	12,914	8,338	6,820
2,400 ≤ Cap _{eff}	2,718	Rockford	15,547	10,084	8,236
300 < Cap _{eff} ≤ 500	400	Chicago	2,820	1,824	1,488
500 < Cap _{eff} ≤ 900	757	Chicago	4,709	3,058	2,506
900 < Cap _{eff} ≤ 1,000	950	Chicago	5,681	3,696	3,031
1,000 < Cap _{eff} ≤ 1,400	1,200	Chicago	6,924	4,512	3,696
1,400 < Cap _{eff} ≤ 1,600	1,499	Chicago	8,364	5,456	4,482
1,600 < Cap _{eff} ≤ 2,100	1,850	Chicago	10,046	6,549	5,384
2,100 < Cap _{eff} ≤ 2,400	2,200	Chicago	11,682	7,634	6,292
2,400 ≤ Cap _{eff}	2,718	Chicago	14,079	9,214	7,583
300 < Cap _{eff} ≤ 500	400	Springfield	2,452	1,588	1,300
500 < Cap _{eff} ≤ 900	757	Springfield	4,095	2,665	2,188
900 < Cap _{eff} ≤ 1,000	950	Springfield	4,950	3,221	2,651
1,000 < Cap _{eff} ≤ 1,400	1,200	Springfield	6,024	3,936	3,240
1,400 < Cap _{eff} ≤ 1,600	1,499	Springfield	7,285	4,767	3,912
1,600 < Cap _{eff} ≤ 2,100	1,850	Springfield	8,732	5,717	4,718
2,100 < Cap _{eff} ≤ 2,400	2,200	Springfield	10,164	6,666	5,500
2,400 ≤ Cap _{eff}	2,718	Springfield	12,258	8,045	6,632
300 < Cap _{eff} ≤ 500	400	Belleville	2,456	1,604	1,320
500 < Cap _{eff} ≤ 900	757	Belleville	4,103	2,687	2,218
900 < Cap _{eff} ≤ 1,000	950	Belleville	4,950	3,249	2,689
1,000 < Cap _{eff} ≤ 1,400	1,200	Belleville	6,036	3,972	3,276
1,400 < Cap _{eff} ≤ 1,600	1,499	Belleville	7,300	4,812	3,972
1,600 < Cap _{eff} ≤ 2,100	1,850	Belleville	8,751	5,772	4,773
2,100 < Cap _{eff} ≤ 2,400	2,200	Belleville	10,186	6,732	5,566
2,400 ≤ Cap _{eff}	2,718	Belleville	12,285	8,127	6,713
300 < Cap _{eff} ≤ 500	400	Marion	2,180	1,444	1,200
500 < Cap _{eff} ≤ 900	757	Marion	3,649	2,430	2,021
900 < Cap _{eff} ≤ 1,000	950	Marion	4,408	2,936	2,442
1,000 < Cap _{eff} ≤ 1,400	1,200	Marion	5,364	3,576	2,988
1,400 < Cap _{eff} ≤ 1,600	1,499	Marion	6,491	4,332	3,613
1,600 < Cap _{eff} ≤ 2,100	1,850	Marion	7,789	5,217	4,348
2,100 < Cap _{eff} ≤ 2,400	2,200	Marion	9,064	6,072	5,082
2,400 ≤ Cap _{eff}	2,718	Marion	10,926	7,339	6,116

WATER AND OTHER NON-ENERGY IMPACT DESCRIPTIONS AND CALCULATION

N/A

DEEMED O&M COST ADJUSTMENT CALCULATION

N/A

MEASURE CODE: CI-HVC-HTHV-V02-230101

REVIEW DEADLINE: 1/1/2028

4.4.40 Gas High Efficiency Single Package Vertical Air Conditioner

DESCRIPTION

This measure covers the installation of a single package vertical air conditioner (SPVAC) with a high efficiency gas furnace, referred to here as a through-the-wall (TTW) condensing gas furnace instead of a standard efficiency gas furnace. The primary market served by TTWs are multifamily housing and hospitality in a new construction application. High efficiency gas furnaces achieve savings through the utilization of a sealed, super insulated combustion chamber, more efficient burners, and multiple heat exchangers that remove a significant portion of the waste heat from the flue gases. Because multiple heat exchangers are used to remove waste heat from the escaping flue gases, most of the flue gases condense and must be drained. Management of the acidic condensate is currently a major limiting factor for retrofit application, making the new construction the best initial market point until the industry develops better strategies for condensate management for retrofit applications. Also, TTWs are normally installed at the exterior wall to access outside air to reject heat in the cooling cycle. Placement of TTWs near the exterior might be prohibitive in retrofit applications. Furnaces equipped with ECM fan motors and with above code EER ratings provide an opportunity for additional electric energy savings.

This measure assumes a unit size less than or equal to 65,000 Btu/hr.

This measure was developed to be applicable to the following program types: NC, TOS. If applied to other program types such as RF, the measure savings should be verified via a custom measure.

DEFINITION OF EFFICIENT EQUIPMENT

To qualify for this measure the installed equipment must be a TTW condensing system with a code minimum 11.0 EER cooling system and a high-efficiency gas furnace with an annual fuel utilization efficiency (AFUE) of 90% or greater.⁹⁴⁷ Fan electrical efficiency must exceed the program requirements.

DEFINITION OF BASELINE EQUIPMENT

Baseline equipment for this measure are units with a cooling system that meets the current code minimum 11.0EER efficiency rating and a heating unit with an AFUE rating of 80% or less.

DEEMED LIFETIME OF EFFICIENT EQUIPMENT

The expected measure life is assumed to be 16.5 years.⁹⁴⁸

DEEMED MEASURE COST

The incremental capital cost for this measure depends on efficiency as listed below:⁹⁴⁹

AFUE	Incremental Cost Premium
80%	\$400
90%	\$400
95%	\$500

LOADSHAPE

Loadshape R08 – Residential Cooling

COINCIDENCE FACTOR

The summer peak coincidence factor for cooling is provided in two different ways below. The first is used to estimate peak savings during the utility peak hour and is most indicative of actual peak benefits. The second represents the average savings over the defined summer peak period and is presented so that savings can be bid into PJM’s capacity market.

⁹⁴⁷ Electronic Code of Federal Regulations: 10 CFR 431.97, last modified on September 23, 2019.

⁹⁴⁸ Average of 15-18 year lifetime estimate made by the Consortium for Energy Efficiency in 2010.

⁹⁴⁹ Based on discussion with TTW Manufacturers at AHR 2018 Show in Chicago, IL.

- CF_{SPP} = Summer System Peak Coincidence Factor for Central A/C (during utility peak hour)
= 68%⁹⁵⁰
- CF_{PJM} = PJM Summer Peak Coincidence Factor for Central A/C (average during PJM peak period)
= 46.6%⁹⁵¹

Algorithm

CALCULATION OF ENERGY SAVINGS

ELECTRIC ENERGY SAVINGS

Electric savings come from a high efficiency cooling unit.⁹⁵² In some instances, the TTW unit provided by the manufacturer may not have higher efficiency cooling and fan blower motor systems integrated into the TTW design; in these cases, electric energy savings will be zero for those components.

$$\Delta kWh_{EER} = FLH_{cool} * Capacity * (1/EER_{base} - 1/EER_{eff}) / 1000$$

Where:

- FLH_{cool} = Full load hours for cooling:⁹⁵³

Climate Zone (City based upon)	FLH _{cool} (multifamily)
1 (Rockford)	499
2 (Chicago)	629
3 (Springfield)	707
4 (Belleville)	982
5 (Marion)	868
Weighted Average	655

- Capacity = Cooling capacity of the efficient unit in Btu/hr
= Actual installed
- EER_{eff} = Energy efficiency ratio of the efficient equipment
= Actual installed rating
- EER_{base} = Energy efficiency ratio of the baseline equipment⁹⁵⁴
= 11.0

For example, for a Rockford non-weatherized multifamily unit conditioned by a SPVAC with a 2-ton (24,000 Btu/hr) cooling capacity, a rated EER of 11.0, and an ECM fan blower motor installed.

⁹⁵⁰ Based on metering of 24 homes with central AC during PY4 and PY5 in Ameren Illinois service territory.
⁹⁵¹ Based on analysis of Itron eShape data for Missouri, calibrated to Illinois loads, supplied by Ameren. The average AC load over the PJM peak period (1-5pm, M-F, June through August) is divided by the maximum AC load during the year.
⁹⁵² If an ECM motor in the packaged system is present, savings should be claimed for this measure by referring to the Residential Furnace Blower Motor measure in the IL TRM.
⁹⁵³ Consistent with multifamily assumptions from Residential Volume. Full load hours for Chicago, Moline, and Rockford are provided in “Final Evaluation Report: Central Air Conditioning Efficiency Services (CACES), 2010, Navigant Consulting”, p.33. An average FLH/Cooling Degree Day (from NCDC) ratio was calculated for these locations and applied to the CDD of the other locations to estimate FLH. There is a county mapping table in Volume 1, Section 3.7 providing the appropriate city to use for each county of Illinois.
⁹⁵⁴ Electronic Code of Federal Regulations: 10 CFR 431.97, last modified on September 23, 2019.

$\Delta kWh = [499 * 24,000 * (1/11.0 - 1/13.0) / 1,000] = 167 \text{ kWh}$

SUMMER COINCIDENT PEAK DEMAND SAVINGS

$$\Delta kW = CF * Capacity * (1/EER_{base} - 1/EER_{eff}) / 1,000$$

Where:

- CF_{SSP} = Summer System Peak Coincidence Factor for Central A/C (during utility peak hour)
= 68%⁹⁵⁵
- CF_{PJM} = PJM Summer Peak Coincidence Factor for Central A/C (average during PJM peak period)
= 46.6%⁹⁵⁶

FOSSIL FUEL SAVINGS

$$\Delta Therms = EFLH_{heat} * Capacity * (AFUE_{eff} - AFUE_{base}) / AFUE_{base} / 100,000$$

Where:

EFLH_{heat} = Equivalent Full Load Hours for heating:

Climate Zone (City based upon)	EFLH _{heat} (general multifamily)
1 (Rockford)	1,924
2 (Chicago)	1,726
3 (Springfield)	1,708
4 (Belleville)	1,195
5 (Marion)	1,270

- Capacity = Nominal heating input capacity furnace size (Btu/hr) for efficient unit
= Actual
- AFUE_{eff} = Efficient furnace annual fuel utilization efficiency rating
= Actual installed rating
- AFUE_{base} = Baseline furnace annual fuel utilization efficiency rating
= 80%
- 100,000 = Btu/Therm

⁹⁵⁵ Based on metering of 24 homes with central AC during PY4 and PY5 in Ameren Illinois service territory.

⁹⁵⁶ Based on analysis of Itron eShape data for Missouri, calibrated to Illinois loads, supplied by Ameren. The average AC load over the PJM peak period (1-5pm, M-F, June through August) is divided by the maximum AC load during the year.

⁹⁵⁷ Consistent with multifamily assumptions from Residential Volume. Full load heating hours for heat pumps are provided for Rockford, Chicago and Springfield in the ENERGY STAR Calculator. Estimates for the other locations were calculated based on the FLH to Heating Degree Day (from NCDC) ratio. VEIC consider ENERGY STAR estimates to be high due to oversizing not being adequately addressed. Using average Illinois billing data (from ICC [commerce Commission](#)) VEIC estimated the average gas heating load and used this to estimate the average home heating output (using 83% average gas heat efficiency). Dividing this by a typical 36,000 Btu/hr ASHP gives an estimate of average ASHP FLH_{heat} of 1821 hours. We used the ratio of this value to the average of the locations using the ENERGY STAR data (1994 hours) to scale down the ENERGY STAR estimates. There is a county mapping table in Volume 1, Section 3.7 providing the appropriate city to use for each county of Illinois.

For example, for a Chicago non-weatherized multifamily unit heated by an SPVAC with a 40 kBtu/hr capacity and a rated AFUE of 93%.

$$\begin{aligned}\Delta\text{Therms} &= 1,726 * 40,000 * [(0.93 - 0.8) / 0.8] / 100,000 \\ &= 112 \text{ therms}\end{aligned}$$

WATER AND OTHER NON-ENERGY IMPACT DESCRIPTIONS AND CALCULATION

N/A

DEEMED O&M COST ADJUSTMENT CALCULATION

N/A

MEASURE CODE: CI-HVC -SPVA-V03-250101

REVIEW DEADLINE: 1/1/2027

4.4.41 Advanced Rooftop Controls (ARC)

DESCRIPTION

The Advanced Rooftop Controls (ARC) measure installs demand-controlled ventilation with optional supply-fan speed control via a variable-frequency drive to a single-zone, packaged HVAC unit with a functioning integrated economizer already installed. The demand-controlled ventilation modulates the outside air damper based on CO₂ concentration in the conditioned space. The supply-fan speed control options consist of setting the fan speed to 40% in ventilation mode and to 90% in heating and cooling modes, or of setting the fan speed to 40% in ventilation mode, to 75% in 1st stage heating and 1st stage cooling modes, and to 90% in 2nd stage heating and 2nd stage cooling modes. The measure results in fan, cooling, and heating savings compared to a baseline scenario of constant-volume, constant-ventilation operation typical of single-zone, packaged HVAC units. There are several off-the-shelf products available for the packaged HVAC unit market that support these control sequences, and the energy savings potential of these strategies has been studied and reported on.⁹⁵⁸

Demand-controlled ventilation modulates the percentage of outside air that is delivered to a space and its occupants by controlling the position of the outside air damper. The outside air damper is set to the minimum position required for the space and is opened further when CO₂ concentration in the conditioned space increases which indicates an increase in occupancy. The damper also opens to provide 100% outside air cooling (i.e., the unit economizes) when conditions permit. This portion of the measure saves energy by minimizing the energy required to unnecessarily heating and cooling outside air. Demand-controlled ventilation can also be combined with the installation of a variable-frequency drive on the supply fan. This drive is used to reduce the speed of the supply fan when the full design airflow is not required. When the unit is only providing ventilation air (i.e., not heating or cooling), the airflow is reduced substantially but not below the required minimum ventilation rate. The flow for heating and cooling can also be reduced a small amount in most cases. Per the fan affinity laws, the reduction in flow correlates to a near cubic reduction in fan power. In these ways, this measure is able to achieve cooling, heating, and fan energy reduction.

This measure is intended for commercial buildings served by single-zone, packaged HVAC units. This measure was developed to be applicable to the following program types: RF, DI.

If applied to other program types, the measure savings should be verified.

DEFINITION OF EFFICIENT EQUIPMENT

The efficient equipment is a single-zone, packaged HVAC unit (with an existing functional integrated economizer) that has been retrofitted with demand-controlled ventilation controls with optional supply-fan speed control via a variable-frequency drive.

DEFINITION OF BASELINE EQUIPMENT

The baseline equipment is a single-zone, packaged HVAC unit (with an existing functional integrated economizer) that lacks demand-controlled ventilation controls and lacks supply-fan speed control via a variable-frequency drive.

DEEMED LIFETIME OF EFFICIENT EQUIPMENT

The deemed measure life is 10 years and based on the estimated life of a CO₂ sensor.⁹⁵⁹

DEEMED MEASURE COST

Actual measure costs should be used if available. If costs are not available, the deemed measure cost below can be used.

⁹⁵⁸ Katipamula, S., et al, “Advanced Rooftop Control (ARC) Retrofit: Field-Test Results”, Pacific Northwest National Laboratory, July 2013.

⁹⁵⁹ During conversations with vendors and Building Automation System (BAS) contractors, it was determined that sensors must be functional for up to 10 years. It is recommended that they are part of a normal preventive maintenance program in which calibration is an important part of extending useful life. Although they are not subject to mechanical failure, they do fall out of tolerance over time.

Table 1 – Deemed Measure Cost Details

Measure	Material Unit (Each)	Material Cost / Unit	Labor Unit (Hours)	Labor Rate/ Unit	Total Cost
DCV	1	\$1,663.90	3	\$96.67	\$1,953.91
DCV and VFD with two speed modes (40% ventilating & 90% heating/cooling)	1	\$3,025.38	4	\$96.67	\$3,412.06
DCV and VFD with three speed modes (40% ventilating, 75% 1 st stage heating/cooling, & 90% 2 nd stage heating/cooling)	1	\$3,487.00	4	\$96.67	\$3,873.68

LOADSHAPE

Commercial ventilation C23

COINCIDENCE FACTOR

CF_{SSP} = Summer System Peak Coincidence Factor for Commercial cooling (during system peak hour)
 = 91.3%⁹⁶⁰

CF_{PJM} = PJM Summer Peak Coincidence Factor for Commercial cooling (average during peak period)
 = 47.8%⁹⁶¹

Algorithm

CALCULATION OF ENERGY SAVINGS

To determine the savings associated with the Advanced Rooftop Controls (ARC) measure we utilized the available IL TRM prototype eQuest models which were initially created by the Energy Center of Wisconsin⁹⁶² but modified by VEIC in 2014 as part of the IL TRM v4.0 Equivalent Full Load Hours (EFLH) update. For each building type we used the most recent versions of the models for our baseline models (Assembly was not part of EFLH update). These models which were used are the most up-to-date versions and are readily available on the [VEIC SharePoint site](#), under the [TRM Reference Documents Section](#).

Upon examination of the ComEd building prototype models we found several of the baseline models did not have packaged single zone (PSZ) units. This measure is targeting packaged single zone HVAC systems. Therefore, as a basis for savings calculations, we chose only models that: 1) utilized PSZ HVAC systems, and 2) aligned with the small commercial building type applicable to this measure. Once the ComEd baseline models were selected, we determined several modifications were necessary to the prototype models in order to represent the baseline scenario for this measure:

1. Multistage PSZ HVAC System with Constant Volume Supply Fan
2. Optimized Economizer Controls by Climate Zone
 - a. Economizer Changeover Type – Set to fixed Dry Bulb
 - b. Economizer High-Limit Control Setpoints – Setpoints based on ASHRAE Climate Zones Fixed Dry Bulb Temperature recommendations.
 - c. Enable Integrated Operation – Allows economizer to operate simultaneously with mechanical cooling

⁹⁶⁰ Based on analysis of Itron eShape data for Missouri, calibrated to Illinois loads, supplied by Ameren. The AC load during the utility’s peak hour is divided by the maximum AC load during the year.

⁹⁶¹Based on analysis of Itron eShape data for Missouri, calibrated to Illinois loads, supplied by Ameren. The average AC load over the PJM peak period (1-5pm, M-F, June through August) is divided by the maximum AC load during the year.

⁹⁶² Energy Center of Wisconsin, ComEd Portfolio Modeling Report, July 30, 2010.

Additionally, several the building prototype models were found to have supply fan total static pressure modeled inputs that seem excessive and atypical for packaged single zone rooftop units – these included convenience stores (5 in. wc), manufacturing facilities (5 in. wc), office low rises (5 in. wc), religious buildings (5 in. wc), and restaurants (5 in. wc). The remaining models had supply fan total static pressure inputs more in line with what we would expect to find for packaged single zone rooftop units, ranging from 1.3 to 2 in. wc. For each model having a supply fan total static pressure above 2 in. wc, model inputs were adjusted to set these to 2 in. wc. To implement the modifications shown above, changes were made to eQUEST keywords in the ComEd prototype models as shown in the following table. Hard-coded system capacities and supply airflows can be found in the attached “Advanced Rooftop Controls_End Use Analysis_IL TRM.xlsx” spreadsheet.

Table 2 – Prototype Modifications to eQuest Keywords

Component Adjusted	eQuest Keyword	IL TR Value	Modified Prototype Value
System - System Type	SYSTEM:TYPE	PSZ	PVVT
System - Airflow and Temperature Control	SYSTEM:AIR/TEMP-CONTROL	N/A	STAGED-VOLUME
System – Supply Fan Total Static Pressure	SYSTEM:SUPPLY-STATIC	Varies	If >2: 2 Else: IL TR Value
System - Cooling and Heating Capacities	SYSTEM:COOLING-CAPACITY SYSTEM:HEATING-CAPACITY	Auto-sized	Hard-coded (after retrieving auto-sized outputs)
System - Supply Fan Control	SYSTEM:FAN-CONTROL	Varies	CONSTANT-VOLUME
System - Supply Fan Ratios	SYSTEM:MIN-FLOW-RATIO SYSTEM:CMIN-FLOW-RATIO SYSTEM:HMIN-FLOW-RATIO SYSTEM:-MAX-FAN-RATIO	N/A	1
System - Supply Airflow	SYSTEM:SUPPLY-FLOW	Auto-sized	Hard-coded (after retrieving auto-sized outputs)
Economizer - Changeover Type	SYSTEM:OA-CONTROL	Fixed	Single Dry-Bulb
Economizer - Changeover Setpoint	SYSTEM-ECONO-LIMIT-T	Varies	ASHRAE 90.1-2013 – High-Limit Shutoff Control Settings: ASHRAE CLIMATE ZONE – 4A = 65°F ASHRAE CLIMATE ZONE – 5A = 70°F
Economizer - Integrated Operation	SYSTEM:ECONO-LOCKOUT	Yes	No

Further modifications were then made to these baseline models to simulate the following measure scenarios:

1. Demand-controlled ventilation (DCV) controls
2. DCV and supply fan variable frequency drive (VFD) with two fan speed modes
 - a. 40% fan speed for ventilating
 - b. 90% fan speed for heating and cooling
3. DCV and supply fan VFD with three fan speed modes
 - a. 40% fan speed for ventilating
 - b. 75% fan speed for 1st stage heating and cooling
 - c. 90% fan speed for 2nd and higher stage heating and cooling

The eQuest modifications from the baseline models to represent these measure scenarios are shown in the following table. Full modeled energy end use and savings summaries can be found in the attached “Advanced Rooftop Controls_End Use Analysis_IL TRM.xlsx” spreadsheet.

Table 3 – Baseline and Measure Scenario eQuest Keywords

Component Adjusted	eQuest Keyword	Baseline Value	Measure Scenario Values		
			1	2	3
System - Minimum Outside Air Control	SYSTEM:MIN-OA-METHOD	Fraction of Design Flow	DCV Return Sensor	DCV Return Sensor	DCV Return Sensor
System - Supply Airflow	SYSTEM:SUPPLY-FLOW	Hard-coded	1.0 × Hard-coded value	0.9 × Hard-coded value	0.9 × Hard-coded value
System - Supply Fan Control	SYSTEM:FAN-CONTROL	CONSTANT-VOLUME	CONSTANT-VOLUME	FAN-EIR-FPLR	FAN-EIR-FPLR
System - Supply Fan Ratios	SYSTEM:MIN-FLOW-RATIO	1	1	0.44*	0.44*
	SYSTEM:CMIN-FLOW-RATIO	1	1	1	0.83**
	SYSTEM:HMIN-FLOW-RATIO	1	1	1	0.83**
	SYSTEM:-MAX-FAN-RATIO	1	1	1	1

*Since the total supply flow is limited by 0.9 of the baseline, a value of 0.44 for the minimum flow ratio results in a 40% fan speed: $0.4/0.9=0.44$

** Since the total supply flow is limited by 0.9 of the baseline, a value of 0.83 for the minimum heating/cooling flow ratios results in a 75% fan speed: $0.75/0.9=0.83$

With these modifications in place each scenario was simulated in eQuest for each chosen IL TRM prototype building type across the five TRM climate zones. Whole building electric and gas savings were determined from the simulation output and are presented in the following sections. Electric savings have been normalized by cooling tons and heating savings by furnace kBtuh output.

ELECTRIC ENERGY SAVINGS

$$\Delta kWh = (\text{Capacity}_{\text{Cool}} \times \text{Normalized Electric Cooling Energy Savings}) + (\text{Capacity}_{\text{Heat}} \times \text{Normalized Electric Heating Energy Savings})$$

Where:

Capacity_{Cool} = capacity of the cooling equipment in tons (nominal tonnage may be used).
 = Actual

Normalized Electric Cooling Energy Savings

= kWh/ton savings value for the appropriate combination of building type, climate zone, and measure scenario per Table 4 – Electric Cooling Energy Savings Summary (kWh/ton)

Table 4 – Electric Cooling Energy Savings Summary (kWh/ton)

Building Type - IL TRM Prototype Model Name	Rockford - Zone 1			Chicago - Zone 2			Springfield - Zone 3			Mt Vernon/Belleville - Zone 4			Marion - Zone 5		
	Measure Scenario:														
	1	2	3	1	2	3	1	2	3	1	2	3	1	2	3
Assembly	52.0	145.8	168.7	51.4	154.6	175.5	85.2	189.0	205.8	95.7	199.7	213.7	89.7	200.8	210.4
Assisted Living	8.0	574.4	604.7	8.8	580.5	605.5	14.7	578.2	598.7	15.6	589.1	609.4	16.5	600.9	615.5
College	49.7	410.8	448.4	54.1	410.4	442.0	106.5	464.1	490.9	139.1	514.3	537.0	158.7	511.9	526.3
Conditioned Storage	1.9	339.8	393.6	3.5	355.1	404.5	5.9	346.3	388.6	9.5	349.5	384.5	10.3	349.5	371.7
Convenience Store	46.4	918.9	984.1	49.9	921.0	977.0	82.3	955.1	1,000.2	86.9	996.3	1,035.0	103.7	998.3	1,022.7
Garage	14.8	479.7	578.9	19.2	482.9	573.6	25.9	510.4	586.3	48.4	570.1	640.3	53.0	589.0	648.7
Grocery	41.8	480.1	505.1	43.9	486.5	507.6	68.1	502.8	520.4	83.2	536.1	550.6	89.7	539.8	547.9
Manufacturing Facility	7.7	773.4	824.8	9.0	761.4	807.1	19.6	771.8	809.3	30.8	801.2	832.8	34.2	784.9	802.5
Office Low Rise	15.2	1,071.2	1,147.3	17.2	1,065.8	1,131.8	23.1	1,062.2	1,115.7	30.5	1,091.4	1,137.7	31.2	1,042.2	1,071.7
Religious Building	6.5	869.4	1,016.9	6.3	894.6	1,029.6	11.1	931.0	1,047.1	15.5	1,005.4	1,108.3	15.0	1,051.1	1,134.0
Restaurant	13.8	554.0	598.2	14.9	574.2	610.8	26.4	564.5	596.6	27.7	606.3	637.2	25.8	603.5	628.3
Retail Department Store	34.0	692.6	751.0	34.4	697.7	749.0	55.4	715.0	757.7	60.8	725.4	761.1	64.3	723.2	743.8
Retail Strip Mall	30.9	739.7	782.5	32.9	734.1	770.5	50.8	748.5	776.8	55.3	761.3	784.8	60.1	755.2	768.4

Capacity_{Heat} = capacity of the heating equipment in tons (nominal tonnage may be used).
= Actual

Normalized Electric Heating Energy Savings

= kWh/ton savings value for the appropriate combination of building type, climate zone, and measure scenario per Table 5 – Electric Energy Heating Savings Summary (kWh/ton)⁹⁶³

⁹⁶³ Values for electric heat are based on converting the gas therm/kBtu/h factors to electric kWh/ton factors factoring in the gas heating efficiencies used in the models and assuming a 2.3 COP heat pump. See 'ARC_ElectricHeatCalculation.xls' for calculation.

Table 5 – Electric Heating Energy Savings Summary (kWh/ton)

	Rockford - Zone 1			Chicago - Zone 2			Springfield - Zone 3			Mt Vernon/Belleville - Zone 4			Marion - Zone 5		
	Measure Scenario: 1 - DCV 2 - DCV and VFD w/ 2-speed fan control 3 - DCV and VFD w/ 3-speed fan control														
Building Type	1	2	3	1	2	3	1	2	3	1	2	3	1	2	3
Assembly	868.6	893.1	893.1	868.6	893.1	893.1	746.3	795.2	783.0	734.0	783.0	770.7	734.0	807.4	795.2
Assisted Living	119.3	59.6	23.9	95.4	47.7	11.9	83.5	35.8	11.9	83.5	59.6	23.9	71.6	59.6	23.9
College	880.8	831.9	807.4	770.7	734.0	709.6	648.4	611.7	599.5	526.1	513.8	489.3	342.5	330.3	318.1
Conditioned Storage	305.8	171.3	146.8	269.1	134.6	110.1	244.7	110.1	85.6	232.4	97.9	73.4	183.5	48.9	36.7
Convenience Store	587.2	464.9	440.4	526.1	403.7	379.2	452.6	342.5	330.3	428.2	330.3	305.8	354.8	269.1	244.7
Garage	59.6	47.7	35.8	47.7	35.8	35.8	47.7	35.8	23.9	47.7	35.8	23.9	47.7	35.8	35.8
Grocery	894.6	835.0	811.1	799.2	739.5	727.6	703.7	656.0	632.2	632.2	596.4	584.5	489.0	453.3	441.3
Manufacturing Facility	59.6	47.7	35.8	47.7	35.8	35.8	47.7	35.8	23.9	35.8	23.9	23.9	23.9	23.9	23.9
Office - Low Rise	334.0	143.1	119.3	298.2	107.4	83.5	238.6	95.4	71.6	214.7	71.6	59.6	155.1	23.9	23.9
Religious Building	107.4	131.2	155.1	95.4	107.4	131.2	83.5	95.4	107.4	71.6	95.4	107.4	71.6	71.6	83.5
Restaurant	345.9	262.4	226.6	298.2	214.7	190.8	262.4	190.8	167.0	238.6	190.8	155.1	202.8	155.1	131.2
Retail - Department Store	298.2	178.9	167.0	274.3	155.1	131.2	238.6	131.2	119.3	214.7	131.2	107.4	178.9	107.4	95.4
Retail - Strip Mall	286.3	226.6	202.8	250.5	190.8	178.9	214.7	167.0	155.1	202.8	167.0	155.1	178.9	143.1	131.2

For example, a 10-ton rooftop heat pump on an office low rise building in Chicago installs DCV with 2-speed supply fan control (operating at 40% in ventilating mode and 90% in heating and cooling modes):

$$\begin{aligned}
 \Delta kWh &= (\text{Capacity}_{\text{Cool}} \times \text{Normalized Electric Cooling Energy Savings}) + (\text{Capacity}_{\text{Heat}} \times \text{Normalized Electric Heating Energy Savings}) \\
 &= (10 \text{ tons} \times 1,065.8 \text{ kWh/ton}) + (10 \text{ tons} \times 107.4 \text{ kWh/ton}) \\
 &= 11,732 \text{ kWh}
 \end{aligned}$$

SUMMER COINCIDENT PEAK DEMAND SAVINGS

$$\Delta kW_{SSP} = (\text{tons}) \times \text{Normalized Electric Cooling Peak Demand Savings} \times CF_{SSP}$$

$$\Delta kW_{PJM} = (\text{tons}) \times \text{Normalized Electric Cooling Peak Demand Savings} \times CF_{PJM}$$

Where:

tons = capacity of the cooling equipment in tons (nominal tonnage may be used).
 = Actual

CF_{SSP} = Summer System Peak Coincidence Factor for Commercial cooling (during system peak hour)
 = 91.3%⁹⁶⁴

CF_{PJM} = PJM Summer Peak Coincidence Factor for Commercial cooling (average during peak period)
 = 47.8%⁹⁶⁵

Normalized Electric Peak Demand Savings

= kW/ton savings value for the appropriate combination of building type, climate zone, and measure scenario per Table 6 – Electric Peak Demand Savings Summary (kW/ton)

Table 6 – Electric Peak Demand Savings Summary (kW/ton)

Building Type - IL TRM Prototype Model Name	Rockford - Zone 1			Chicago - Zone 2			Springfield - Zone 3			Mt Vernon/Belleville - Zone 4			Marion - Zone 5		
	Measure Scenario:														
	1	2	3	1	2	3	1	2	3	1	2	3	1	2	3
Assembly	0.024	0.107	0.107	0.086	0.126	0.126	0.015	0.042	0.042	0.069	0.095	0.095	0.048	0.064	0.064
Assisted Living	0.021	0.116	0.116	0.021	0.075	0.075	0.018	0.086	0.086	0.021	0.092	0.092	0.024	0.081	0.081
College	0.007	0.207	0.207	0.007	0.090	0.090	0.006	0.179	0.179	0.005	0.132	0.132	0.009	0.074	0.074
Conditioned Storage	0.007	0.065	0.065	0.006	0.083	0.083	0.010	0.096	0.096	0.005	0.060	0.060	0.007	0.071	0.071
Convenience Store	0.047	0.369	0.369	0.053	0.394	0.394	0.042	0.395	0.395	0.017	0.356	0.356	0.067	0.390	0.390
Garage	0.012	0.054	0.054	0.011	0.053	0.053	0.011	0.053	0.053	0.011	0.068	0.068	0.007	0.061	0.061
Grocery	0.065	0.122	0.122	0.034	0.080	0.080	0.033	0.088	0.088	0.072	0.119	0.119	0.033	0.082	0.082
Manufacturing Facility	0.008	0.335	0.335	0.006	0.296	0.296	-0.003	0.283	0.283	0.000	0.333	0.333	0.049	0.376	0.376
Office Low Rise	0.011	0.395	0.395	0.009	0.346	0.346	0.007	0.366	0.366	0.011	0.384	0.384	0.029	0.385	0.385
Religious Building	0.000	0.462	0.465	0.000	0.406	0.409	0.000	0.461	0.461	0.000	0.456	0.457	0.000	0.464	0.467
Restaurant	0.030	0.231	0.231	0.034	0.162	0.162	0.023	0.113	0.113	0.033	0.134	0.134	0.006	0.069	0.069
Retail Department Store	0.057	0.152	0.152	0.042	0.120	0.120	0.029	0.099	0.099	0.029	0.113	0.113	0.066	0.149	0.149
Retail Strip Mall	0.046	0.171	0.171	0.046	0.191	0.191	0.042	0.189	0.189	0.020	0.158	0.158	0.066	0.178	0.178

⁹⁶⁴ Based on analysis of Itron eShape data for Missouri, calibrated to Illinois loads, supplied by Ameren. The AC load during the utility’s peak hour is divided by the maximum AC load during the year.

⁹⁶⁵ Based on analysis of Itron eShape data for Missouri, calibrated to Illinois loads, supplied by Ameren. The average AC load over the PJM peak period (1-5pm, M-F, June through August) is divided by the maximum AC load during the year.

For example, a 10-ton rooftop air conditioner on an office low rise building in Chicago installs DCV with 2-speed supply fan control (operating at 40% in ventilating mode and 90% in heating and cooling modes) using the Summer System Peak Coincidence Factor:

$$\begin{aligned} \Delta kW &= (10 \text{ tons}) \times (0.346 \text{ kW/ton}) \times 91.3\% \\ &= 3.159 \text{ kW} \end{aligned}$$

FOSSIL FUEL SAVINGS

$$\Delta \text{Therms} = (\text{kBtuh output}) \times \text{Normalized Gas Energy Savings}$$

Where:

kBtuh = heating output of the gas furnace in kBtuh
 = Actual

Normalized Gas Energy Savings

= therms/kBtuh output savings value for the appropriate combination of building type, climate zone, and measure scenario per Table 7 – Gas Energy Savings Summary (therms/kBtuh output)

Table 7 – Gas Energy Savings Summary (therms/kBtuh output)

Building Type - IL TRM Prototype Model Name	Rockford - Zone 1			Chicago - Zone 2			Springfield - Zone 3			Mt Vernon/Belleville - Zone 4			Marion - Zone 5		
	Measure Scenario:														
	1	2	3	1	2	3	1	2	3	1	2	3	1	2	3
Assembly	7.1	7.3	7.3	7.1	7.3	7.3	6.1	6.5	6.4	6.0	6.4	6.3	6.0	6.6	6.5
Assisted Living	1.0	0.5	0.2	0.8	0.4	0.1	0.7	0.3	0.1	0.7	0.5	0.2	0.6	0.5	0.2
College	7.2	6.8	6.6	6.3	6.0	5.8	5.3	5.0	4.9	4.3	4.2	4.0	2.8	2.7	2.6
Conditioned Storage	2.5	1.4	1.2	2.2	1.1	0.9	2.0	0.9	0.7	1.9	0.8	0.6	1.5	0.4	0.3
Convenience Store	4.8	3.8	3.6	4.3	3.3	3.1	3.7	2.8	2.7	3.5	2.7	2.5	2.9	2.2	2.0
Garage	0.5	0.4	0.3	0.4	0.3	0.3	0.4	0.3	0.2	0.4	0.3	0.2	0.4	0.3	0.3
Grocery	7.5	7.0	6.8	6.7	6.2	6.1	5.9	5.5	5.3	5.3	5.0	4.9	4.1	3.8	3.7
Manufacturing Facility	0.5	0.4	0.3	0.4	0.3	0.3	0.4	0.3	0.2	0.3	0.2	0.2	0.2	0.2	0.2
Office Low Rise	2.8	1.2	1.0	2.5	0.9	0.7	2.0	0.8	0.6	1.8	0.6	0.5	1.3	0.2	0.2
Religious Building	0.9	1.1	1.3	0.8	0.9	1.1	0.7	0.8	0.9	0.6	0.8	0.9	0.6	0.6	0.7
Restaurant	2.9	2.2	1.9	2.5	1.8	1.6	2.2	1.6	1.4	2.0	1.6	1.3	1.7	1.3	1.1
Retail Department Store	2.5	1.5	1.4	2.3	1.3	1.1	2.0	1.1	1.0	1.8	1.1	0.9	1.5	0.9	0.8
Retail Strip Mall	2.4	1.9	1.7	2.1	1.6	1.5	1.8	1.4	1.3	1.7	1.4	1.3	1.5	1.2	1.1

For example, a rooftop unit with a 148 kBtuh output gas furnace on an office low-rise building in Chicago installs DCV with 2-speed supply fan control (operating at 40% in ventilating mode and 90% in heating and cooling modes):

$$\begin{aligned} \Delta \text{Therms} &= (148 \text{ kBtuh}) \times (0.9 \text{ therms/kBtuh output}) \\ &= 133.2 \text{ therms} \end{aligned}$$

WATER AND OTHER NON-ENERGY IMPACT DESCRIPTIONS AND CALCULATION

N/A

DEEMED O&M COST ADJUSTMENT CALCULATION

N/A

MEASURE CODE: CI-HVC-ARTC-V03-230101

REVIEW DEADLINE: 1/1/2027

4.4.42 Advanced Thermostats for Small Commercial – Retired 12/31/2019. Replaced with
4.4.48 Small Commercial Thermostats

4.4.43 Packaged RTU Sealing

DESCRIPTION

The HVAC Packaged RTU Sealing Measure targets areas of the RTU that are readily accessible and can be easily sealed. By sealing the following areas, the amount of uncontrolled infiltration will be reduced leading to increased occupant comfort and an overall reduction in energy use.

The measure seeks to target the following three areas for sealing.

1. Economizer Hood – Seal the interior and exterior seams that connect the economizer to the RTU using UL listed metal tape and/or silicone caulking.
2. RTU Curb – Seal supply and return duct seams inside of RTU with mastic along with any leaks that are found around the perimeter of the roof to RTU connection using UL listed metal tape and/or silicone caulking.
3. Non-Removable Cabinet Panels – Seal all cabinet seams that are not typically removed during basic service (i.e., control panel) using UL listed metal tape and/or silicone caulking.

Uncontrolled infiltration of non-conditioned outside air (OSA) is a known issue for packaged rooftop units (RTU). This leakage can occur thru the curb, economizer assembly connection and cabinet panels. This leakage not only influences occupant comfort but also increases energy usage by increasing the heating and cooling loads while also reducing the unit's operating energy efficiency.

Prior to a recently released laboratory and field study developed by Robert Mowris & Associates, Inc.,⁹⁶⁶ the energy effects of uncontrolled infiltration through cabinet leakage were difficult to quantify. However, this study determined that uncontrolled OSA infiltration not only increases the amount of energy to condition the excess air but also reduces the unit's operating efficiency (sensible EER) by 5.4%. By reducing the amount of uncontrolled OSA infiltration through RTU sealing the unit's operating efficiency (EER) can be increased reducing the amount of cooling energy. (Note: The referenced study quantifies improvements only from sealing the economizer hood – sealing the curb and non-access panels are recommended practice here but savings have not been quantified for these actions and may be in a future revision.)

This measure is only appropriate for packaged single zone rooftop units. Custom calculations are required for savings for built up air handling units or packaged multizone systems.

DEFINITION OF EFFICIENT EQUIPMENT

The efficient equipment condition is assumed to be a packaged HVAC system that has had the economizer hood, curb and non-access cabinet panels sealed.

DEFINITION OF BASELINE EQUIPMENT

The baseline equipment condition is assumed to be an operational packaged HVAC system that has not been previously sealed. The packaged HVAC systems must be single zone and must have a functioning economizer.

DEEMED LIFETIME OF EFFICIENT EQUIPMENT

Because the measure targets existing packaged RTU units, the deemed lifetime of the measure is assumed to be 5 years.⁹⁶⁷

DEEMED MEASURE COST

Actual measure costs should be used if available. If costs are not available, the deemed measure cost below listed below can be used. The deemed measure costs are detailed for each individual RTU.

⁹⁶⁶Robert Mowris & Associates, Inc., "Laboratory Test Results of Commercial Packaged HVAC Maintenance Faults," California Public Utilities Commission, Feb 15, 2016 page 203.

⁹⁶⁷ Assumed to be one third of effective useful life of an RTU (15 years).

Measure	Material Unit	Material Cost / Unit	Labor Unit (Hours)	Labor Rate / Unit	Total Cost
HVAC Packaged RTU Sealing	1	\$48.99	1.5	\$97	\$194.49

LOADSHAPE

Loadshape C03 - Commercial Cooling

COINCIDENCE FACTOR

CF_{SSP} = Summer System Peak Coincidence Factor for Commercial cooling (during system peak hour)
 = 91.3%⁹⁶⁸

CF_{PJM} = PJM Summer Peak Coincidence Factor for Commercial cooling (average during peak period)
 = 47.8%⁹⁶⁹

Algorithm

CALCULATION OF ENERGY SAVINGS

To determine the savings associated with the Packaged RTU Sealing measure available IL TRM prototype eQuest models, which were initially created by the Energy Center of Wisconsin⁹⁷⁰ but modified by VEIC in 2014 as part of the IL TRM v4.0 Equivalent Full Load Hours (EFLH) update, were utilized. For each building type we used the most recent versions of the models for our baseline models (Assembly was not part of EFLH update).

This measure is targeting packaged single zone HVAC systems. Therefore, as a basis for savings calculations, only models that had the following characteristics were chosen: 1) Packaged-Single Zone (PSZ) HVAC systems; and 2) aligned with the small commercial building type applicable to this measure. Several modifications to the models were necessary in order to simulate a functioning airside economizer, which is assumed to be present in the baseline scenario for this measure:

- 3) Optimized Economizer Controls by Climate Zone
 - a. Economizer Changeover Type – Set to fixed Dry Bulb
 - b. Economizer High-Limit Control Setpoints – Setpoints based on ASHRAE Climate Zones Fixed Dry Bulb Temperature recommendations.
 - c. Enable Integrated Operation – Allows economizer to operate simultaneously with mechanical cooling

To determine the energy use associated with an unsealed RTU, the prototype models were modified using the associated reduction in efficiency reported in a Robert Mowris and Associates, Inc. study that was performed for the California Public Utilities Commission in 2016.⁹⁷¹ For further detail on the full modeled energy end use and savings summaries, see: “Packaged RTU Sealing_End Use Analysis_IL TRM 09042018.xlsx” spreadsheet.

After analyzing the modeled cooling annual energy usage for both the baseline (unsealed) and measure (sealed) model scenarios it was determined that the building type and climate zone variables had a minimal impact on the overall energy savings associated with the measure. As a result, the overall average savings factor of 4.67% was deemed applicable for any small commercial building type across all climate zones. This single savings value used in conjunction with the energy and demand savings calculations listed in the following sections will allow the savings

⁹⁶⁸ Based on analysis of Itron eShape data for Missouri, calibrated to Illinois loads, supplied by Ameren. The AC load during the utility’s peak hour is divided by the maximum AC load during the year.

⁹⁶⁹ Based on analysis of Itron eShape data for Missouri, calibrated to Illinois loads, supplied by Ameren. The average AC load over the PJM peak period (1-5pm, M-F, June through August) is divided by the maximum AC load during the year.

⁹⁷⁰ Energy Center of Wisconsin, ComEd Portfolio Modeling Report, July 30, 2010.

⁹⁷¹ Robert Mowris & Associates, Inc., “Laboratory Test Results of Commercial Packaged HVAC Maintenance Faults,” California Public Utilities Commission, Feb 15, 2016 Section 5.4.

to be calculated based on the unit size and equivalent full load hours listed in the Illinois Technical Resource Manual (TRM).

ELECTRIC ENERGY SAVINGS

$$\Delta kWh = (kBtu/hr) / EER_{before} * EFLH_{cooling} * \%Savings$$

Where:

- kBtu/hr = rated capacity of the cooling equipment actually installed in kBtu per hour (1 ton of cooling capacity equals 12 kBtu/hr).
= Actual
- EER_{before} = Energy Efficiency Ratio (EER) of the baseline equipment
= Actual
- %Savings = Deemed savings percentage
= 4.67%⁹⁷²
- EFLH_{cooling} = Equivalent Full Load Hours for cooling in Existing Buildings from section 4.4 HVAC End Use

For example, a 12 EER 5-ton rooftop air conditioner on a department store in Rockford receives packaged RTU sealing:

$$\begin{aligned} \Delta kWh &= (5 * 12) / 12 * 639 * 4.67\% \\ &= 149.2 kWh \end{aligned}$$

SUMMER COINCIDENT PEAK DEMAND SAVINGS

$$\Delta kW_{ssp} = (kBtu/hr) / EER_{before} * \%Savings * CF_{SSP}$$

$$\Delta kW_{pjm} = (kBtu/hr) / EER_{before} * \%Savings * CF_{PJM}$$

Where:

- kBtu/hr = Capacity of the cooling equipment actually installed in kBtu per hour (1 ton of cooling capacity equals 12 kBtu/hr).
= Actual
- EER_{before} = Energy Efficiency Ratio (EER) of the baseline equipment
= Actual
- %Savings = Deemed savings percentage
= 4.67%
- CF_{SSP} = Summer System Peak Coincidence Factor for Commercial cooling (during system peak hour)

⁹⁷² The average cooling energy savings for all building types and climate zones, as determined by modeling 13 small commercial building types across 5 weather zones utilizing the prototype TRM eQuest models. For additional reference on the methodology and approach to the calculation of the deemed savings factor, see “Packaged RTU Sealing_End Use Analysis_IL TRM 2022.xlsx”.

$$= 91.3\%^{973}$$

CF_{PJM} = PJM Summer Peak Coincidence Factor for Commercial cooling (average during peak period)

$$= 47.8\%^{974}$$

For example, a 12 EER 5-ton rooftop air conditioner using the Summer System Peak Coincidence Factor receives RTU sealing:

$$\begin{aligned} \Delta kW &= (5 \cdot 12) / 12 * 4.67\% * 91.3\% \\ &= 0.213 \text{ kW} \end{aligned}$$

FOSSIL FUEL SAVINGS

$$\Delta Therm = (kBtu/hr) / 100 / Efficiency_{before} * EFLH_{heating} * \%Savings$$

Where:

kBtu/hr = rated capacity of the heating equipment actually installed in kBtu per hour
= Actual

100 = Converts kBtu/hr to Therms/hr

Efficiency_{before} = Efficiency of the baseline equipment (rated)
= Actual

%Savings = Deemed savings percentages by building type and climate zone are provided in the following table

Building Type	Savings Percentage				
	Zone 1 (Rockford)	Zone 2 (Chicago)	Zone 3 (Springfield)	Zone 4 (Belleville)	Zone 5 (Marion)
Assembly	2.84%	2.86%	2.86%	2.98%	2.94%
Assisted Living	4.01%	4.15%	4.35%	4.64%	5.44%
College	3.86%	3.88%	3.97%	4.09%	5.10%
Conditioned Storage (Warehouse)	0.92%	0.90%	0.87%	1.00%	1.23%
Convenience Store	3.07%	3.20%	3.43%	3.70%	4.63%
Garage	0.20%	0.21%	0.22%	0.23%	0.29%
Grocery	3.38%	3.49%	3.60%	3.79%	4.57%
Manufacturing Facility	0.18%	0.16%	0.16%	0.16%	0.16%
Office - Low Rise	2.19%	2.23%	2.37%	2.46%	2.96%
Religious Building	0.28%	0.28%	0.30%	0.31%	0.37%
Restaurant	2.76%	2.83%	2.96%	3.11%	3.58%
Retail - Department Store	1.87%	1.91%	2.00%	2.14%	2.88%
Retail - Strip Mall	2.06%	2.12%	2.29%	2.46%	3.17%

EFLH_{heating} = Equivalent Full Load Hours for heating in Existing Buildings from section 4.4 HVAC End Use

⁹⁷³ Based on analysis of Itron eShape data for Missouri, calibrated to Illinois loads, supplied by Ameren. The AC load during the utility’s peak hour is divided by the maximum AC load during the year.

⁹⁷⁴ Based on analysis of Itron eShape data for Missouri, calibrated to Illinois loads, supplied by Ameren. The average AC load over the PJM peak period (1-5pm, M-F, June through August) is divided by the maximum AC load during the year.

For example, a packaged RTU with an 80% efficient 150-kBtu/hr gas furnace on a department store in Rockford receives packaged RTU sealing:

$$\begin{aligned}\Delta\text{Therm} &= (150 / 100) / 80\% * 1,365 * 1.87\% \\ &= 47.9 \text{ Therms}\end{aligned}$$

WATER AND OTHER NON-ENERGY IMPACT DESCRIPTIONS AND CALCULATION

N/A

DEEMED O&M COST ADJUSTMENT CALCULATION

N/A

MEASURE CODE: CI-HVC-PRTU-V02-230101

REVIEW DEADLINE: 1/1/2026

4.4.44 Commercial Ground Source and Ground Water Source Heat Pump

DESCRIPTION

This measure characterizes the installation of a Ground Source Heat Pump under the following scenarios:

- A. New Construction:
 - i. The installation of a new Ground Source Heat Pump system meeting ENERGY STAR efficiency standards presented below in a new C&I building.
 - ii. Note the baseline in this case should be determined via EM&V and the algorithms are provided to allow savings to be calculated from any baseline condition.
- B. Time of Sale:
 - i. The planned installation of a new Ground Source Heat Pump system meeting ENERGY STAR efficiency standards presented below to replace an existing system(s) that does not meet the criteria for early replacement described in section C below.
 - ii. Note the baseline in this case is an equivalent replacement system to that which exists currently in the building. Where unknown, the baseline should be determined via EM&V and the algorithms are provided to allow savings to be calculated from any baseline condition. The calculation of savings is dependent on whether an incentive for the installation has been provided by both a gas and electric utility, only an electric utility or only a gas utility.
 - iii. DHW savings are calculated based upon the fuel type and efficiency of the existing unit.
- C. Early Replacement/Retrofit:
 - i. The early removal of functioning electric or gas space heating and/or cooling systems from service, prior to the natural end of life, and replacement with a new high efficiency Ground Source Heat Pump system.
 - ii. Note the baseline in this case is the existing equipment being replaced. The calculation of savings is dependent on whether an incentive for the installation has been provided by both a gas and electric utility, only an electric utility or only a gas utility. DHW savings are calculated based upon the fuel and efficiency of the existing unit.
 - iii. Early Replacement determination will be based on meeting the following conditions:
 - The existing unit is operational when replaced, or
 - The existing unit requires minor repairs to be operational, defined as costing less than:⁹⁷⁵

Existing System	Maximum repair cost
Air Source Heat Pump	\$263/ton
Chiller	\$308/ton
Boiler (Steam)	\$3.87/kBtu
Boiler (Hot Water)	\$4.25/kBtu
Furnace	\$2.49/kBtu
Ground Source Heat Pump	\$2,185/ton

- All other conditions will be considered Time of Sale.

The Baseline efficiency of the existing unit replaced:

- Use actual existing efficiency whenever possible.
- If the efficiency of the existing unit is unknown, use assumptions based on the federal minimum standards provided in tables below.
- If the operational status or repair cost of the existing unit is unknown use time of sale assumptions.

⁹⁷⁵ The Technical Advisory Committee agreed that if the cost of repair is less than 20% of the new baseline replacement cost (defined in the Measure Costs section), it can be considered early replacement.

The installation of the GSHP should meet the following design parameters to ensure a properly sized circulation pump. If the GSHP design does not meet the following parameters, a custom calculation should be performed to account for the motor energy consumed by the circulation pump. Optimal design parameters are:

- Circulation pump is included in the manufacturer assembly of the GSHP system
Or;
- Circulation pump flow rate less than or equal to 3.0 GPM per system ton
- Variable flow controls on pumps serving systems greater than 10 tons. Variable flow controls include one of the following:
 - A variable speed system pump controlled from differential pressure and 2-way water flow control valves on each heat pump.
 - Individual on/off pumps on each heat pump controlled by heat pump demand. The heat pumps may be decoupled from the ground heat exchanger using a separate variable speed pump controlled by differential temperature across the ground loop.
- On/off or variable flow controls on pumps for systems less than 10 tons. On/off pump controls shall operate only when heat pump(s) are running.
- System pumping head less than 80 feet. For systems 10 tons or smaller system pumping head should not exceed 40 feet.

This measure was developed to be applicable to the following program types: TOS, NC, EREP. If applied to other program types, the measure savings should be verified.

DEFINITION OF EFFICIENT EQUIPMENT

For these products, the baseline equipment includes Air Conditioning, Space Heating and Domestic Hot Water Heating.

New Construction:

To calculate savings with an electric baseline, the baseline equipment is assumed to be an Air Source Heat Pump meeting the Federal Standard efficiency level as outlined in Table 2 (effective 1/1/2016 to 6/30/2019) or Table 7 (effective 7/1/2019 to 9/30/2022) or Table 12 (effective 10/1/2022) ; and a Federal Standard electric hot water heater efficiency level as outlined in Table 6 (effective 1/1/2016 to 6/30/2019) or Table 11 (effective 7/1/2019 to 9/30/2022) or Table 16 (effective 10/1/2022).

To calculate savings with a chiller/unitary cooling systems and boiler/furnace baseline, the baseline equipment is assumed to meet the minimum standard efficiencies as outlined in the Table 3 (effective 1/1/2016 to 6/30/2019) or Table 8 (effective 7/1/2019 to 9/30/2022) or Table 13 (effective 10/1/2022)

Table for chillers/unitary cooling systems, and Table 4 (effective 1/1/2016 to 6/30/2019) or Table 9 (effective 7/1/2019 to 9/30/2022) or Table 14 (effective 10/1/2022) for boilers or Table 5 (effective 1/1/2016 to 6/30/2019) or Table 10 (effective 7/1/2019 to 9/30/2022) or Table 15 (effective 10/1/2022) for furnaces. If a desuperheater is installed, the domestic hot water heater minimum standard efficiency is calculated as per Table 6 (effective 1/1/2016 to 6/30/2019) or Table 11 (effective 7/1/2019 to 9/30/2022) or Table 16 (effective 10/1/2022) below.

In order for this characterization to apply, the baseline equipment is assumed to meet the efficiency requirements within the IECC code in effect on the date of the building permit. As code requirements and adoption can differ from municipality to municipality, the user should verify which version of code is applicable given these constraints.

Note, IECC 2021 became effective statewide on 1/1/2024. IECC 2018 is the requisite code for any projects with permitting dates spanning July 1, 2019 to 12/31/2023. Prior to July 1, 2019, IECC 2015 is the applicable code. If evaluation determines the applicable version of code, given location and timing, isn't an appropriate baseline due to supply constraints, low compliance, or other issues, the previous iteration of code may be used through 2023.

IECC 2021 leverages new DOE testing methods and associated metrics. The following conversion factors are recommended for use if the efficient equipment is not rated under the new testing procedure but the stipulated baseline is:⁹⁷⁶

$$\text{SEER2} = X * \text{SEER}$$

$$\text{EER2} = X * \text{EER}$$

$$\text{HSPF2} = X * \text{HSPF}$$

Where:

X	SEER2	EER2	HSPF2
Ducted	0.95	0.95	0.85
Ductless	1.00	1.00	0.90
Packaged	0.95	0.95	0.84

⁹⁷⁶ Consortium for Energy Efficiency (CEE), Testing, Testing, M1, 2, 3, Transitioning to New Federal Minimum Standards, CEE Summer Program Meeting, June 10, 2022.

Table 2: IECC 2015 ASHP Minimum Efficiency Requirements (effective 1/1/2016 to 6/30/2019):

EQUIPMENT TYPE	SIZE CATEGORY	HEATING SECTION TYPE	SUBCATEGORY OR RATING CONDITION	MINIMUM EFFICIENCY		TEST PROCEDURE ^a
				Before 1/1/2016	As of 1/1/2016	
Air cooled (cooling mode)	< 65,000 Btu/h ^b	All	Split System	13.0 SEER ^c	14.0 SEER ^c	AHRI 210/240
			Single Package	13.0 SEER ^c	14.0 SEER ^c	
Through-the-wall, air cooled	≤ 30,000 Btu/h ^b	All	Split System	12.0 SEER	12.0 SEER	
			Single Package	12.0 SEER	12.0 SEER	
Single-duct high-velocity air cooled	< 65,000 Btu/h ^b	All	Split System	11.0 SEER	11.0 SEER	
Air cooled (cooling mode)	≥ 65,000 Btu/h and < 135,000 Btu/h	Electric Resistance (or None)	Split System and Single Package	11.0 EER 11.2 IEER	11.0 EER 12.0 IEER	
			All other	Split System and Single Package	10.8 EER 11.0 IEER	10.8 EER 11.8 IEER
	≥ 135,000 Btu/h and < 240,000 Btu/h	Electric Resistance (or None)	Split System and Single Package	10.6 EER 10.7 IEER	10.6 EER 11.6 IEER	
			All other	Split System and Single Package	10.4 EER 10.5 IEER	10.4 EER 11.4 IEER
	≥ 240,000 Btu/h	Electric Resistance (or None)	Split System and Single Package	9.5 EER 9.6 IEER	9.5 EER 10.6 IEER	
			All other	Split System and Single Package	9.3 EER 9.4 IEER	9.3 EER 9.4 IEER
Air cooled (heating mode)	< 65,000 Btu/h ^b	—	Split System	7.7 HSPF ^c	8.2 HSPF ^c	AHRI 210/240
			Single Package	7.7 HSPF ^c	8.0 HSPF ^c	
Through-the-wall, (air cooled, heating mode)	≤ 30,000 Btu/h ^b (cooling capacity)	—	Split System	7.4 HSPF	7.4 HSPF	
			Single Package	7.4 HSPF	7.4 HSPF	
Small-duct high velocity (air cooled, heating mode)	< 65,000 Btu/h ^b	—	Split System	6.8 HSPF	6.8 HSPF	
Air cooled (heating mode)	≥ 65,000 Btu/h and < 135,000 Btu/h (cooling capacity)	—	47°F db/43°F wb outdoor air	3.3 COP	3.3 COP	
			17°Fdb/15°F wb outdoor air	2.25 COP	2.25 COP	
	≥ 135,000 Btu/h (cooling capacity)	—	47°F db/43°F wb outdoor air	3.2 COP	3.2 COP	
			17°Fdb/15°F wb outdoor air	2.05 COP	2.05 COP	

Table 3: IECC 2015 Electric Chillers, Air-Cooled and Water-Cooled minimum efficiencies (effective 1/1/2016 to 6/30/2019)

EQUIPMENT TYPE	SIZE CATEGORY	UNITS	BEFORE 1/1/2015		AS OF 1/1/2015		TEST PROCEDURE ^c
			Path A	Path B	Path A	Path B	
Air-cooled chillers	< 150 Tons	EER (Btu/W)	≥ 9.562 FL	NA ^c	≥ 10.100 FL	≥ 9.700 FL	AHRI 550/590
			≥ 12.500 IPLV		≥ 13.700 IPLV	≥ 15.800 IPLV	
	≥ 150 Tons		≥ 9.562 FL	NA ^c	≥ 10.100 FL	≥ 9.700 FL	
			≥ 12.500 IPLV		≥ 14.000 IPLV	≥ 16.100 IPLV	
Air cooled without condenser, electrically operated	All capacities	EER (Btu/W)	Air-cooled chillers without condenser shall be rated with matching condensers and complying with air-cooled chiller efficiency requirements.				
Water cooled, electrically operated positive displacement	< 75 Tons	kW/ton	≤ 0.780 FL	≤ 0.800 FL	≤ 0.750 FL	≤ 0.780 FL	
			≤ 0.630 IPLV	≤ 0.600 IPLV	≤ 0.600 IPLV	≤ 0.500 IPLV	
	≥ 75 tons and < 150 tons		≤ 0.775 FL	≤ 0.790 FL	≤ 0.720 FL	≤ 0.750 FL	
			≤ 0.615 IPLV	≤ 0.586 IPLV	≤ 0.560 IPLV	≤ 0.490 IPLV	
	≥ 150 tons and < 300 tons		≥ 0.680 FL	≥ 0.718 FL	≥ 0.660 FL	≥ 0.680 FL	
			≥ 0.580 IPLV	≥ 0.540 IPLV	≥ 0.540 IPLV	≥ 0.440 IPLV	
	≥ 300 tons and < 600 tons		≤ 0.620 FL	≤ 0.639 FL	≤ 0.610 FL	≤ 0.625 FL	
			≤ 0.540 IPLV	≤ 0.490 IPLV	≤ 0.520 IPLV	≤ 0.410 IPLV	
≥ 600 tons	≤ 0.620 FL	≤ 0.639 FL	≤ 0.560 FL	≤ 0.585 FL			
		≤ 0.540 IPLV	≤ 0.490 IPLV	≤ 0.500 IPLV	≤ 0.380 IPLV		
Water cooled, electrically operated centrifugal	< 150 Tons	kW/ton	≤ 0.634 FL	≤ 0.639 FL	≤ 0.610 FL	≤ 0.695 FL	
			≤ 0.596 IPLV	≤ 0.450 IPLV	≤ 0.550 IPLV	≤ 0.440 IPLV	
	≥ 150 tons and < 300 tons		≤ 0.634 FL	≤ 0.639 FL	≤ 0.610 FL	≤ 0.635 FL	
			≤ 0.596 IPLV	≤ 0.450 IPLV	≤ 0.550 IPLV	≤ 0.400 IPLV	
	≥ 300 tons and < 400 tons		≤ 0.576 FL	≤ 0.600 FL	≤ 0.560 FL	≤ 0.595 FL	
			≤ 0.549 IPLV	≤ 0.400 IPLV	≤ 0.520 IPLV	≤ 0.390 IPLV	
	≥ 400 tons and < 600 tons		≤ 0.576 FL	≤ 0.600 FL	≤ 0.560 FL	≤ 0.585 FL	
			≤ 0.549 IPLV	≤ 0.400 IPLV	≤ 0.500 IPLV	≤ 0.380 IPLV	
≥ 600 Tons	≤ 0.570 FL	≤ 0.590 FL	≤ 0.560 FL	≤ 0.585 FL			
		≤ 0.539 IPLV	≤ 0.400 IPLV	≤ 0.500 IPLV	≤ 0.380 IPLV		
Air cooled, absorption, single effect	All capacities	COP	≥ 0.600 FL	NA ^c	≥ 0.600 FL	NA ^c	AHRI 560
Water cooled absorption, single effect	All capacities	COP	≥ 0.700 FL	NA ^c	≥ 0.700 FL	NA ^c	
Absorption, double effect, indirect fired	All capacities	COP	≥ 1.000 FL	NA ^c	≥ 1.000 FL	NA ^c	
			≥ 1.050 IPLV		≥ 1.050 IPLV		
Absorption double effect direct fired	All capacities	COP	≥ 1.000 FL	NA ^c	≥ 1.000 FL	NA ^c	
			≥ 1.000 IPLV		≥ 1.050 IPLV		

Table 4: IECC 2015 Boiler minimum efficiency requirements (effective 1/1/2016 to 6/30/2019)

EQUIPMENT TYPE ^a	SUBCATEGORY OR RATING CONDITION	SIZE CATEGORY (INPUT)	MINIMUM EFFICIENCY ^{d, e}	TEST PROCEDURE
Boilers, hot water	Gas-fired	< 300,000 Btu/h	80% AFUE	10 CFR Part 430
		≥ 300,000 Btu/h and ≤ 2,500,000 Btu/h ^b	80% E_t	10 CFR Part 431
		> 2,500,000 Btu/h ^a	82% E_c	
	Oil-fired ^c	< 300,000 Btu/h	80% AFUE	10 CFR Part 430
		≥ 300,000 Btu/h and ≤ 2,500,000 Btu/h ^b	82% E_t	10 CFR Part 431
> 2,500,000 Btu/h ^a	84% E_c			
Boilers, steam	Gas-fired	< 300,000 Btu/h	75% AFUE	10 CFR Part 430
	Gas-fired- all, except natural draft	≥ 300,000 Btu/h and ≤ 2,500,000 Btu/h ^b	79% E_t	10 CFR Part 431
		> 2,500,000 Btu/h ^a	79% E_t	
	Gas-fired-natural draft	≥ 300,000 Btu/h and ≤ 2,500,000 Btu/h ^b	77% E_t	
		> 2,500,000 Btu/h ^a	77% E_t	
	Oil-fired ^c	< 300,000 Btu/h	80% AFUE	10 CFR Part 430
		≥ 300,000 Btu/h and ≤ 2,500,000 Btu/h ^b	81% E_t	10 CFR Part 431
		> 2,500,000 Btu/h ^a	81% E_t	

Table 5: IECC 2015 Warm-air Furnace minimum efficiency standards (effective 1/1/2016 to 6/30/2019)

EQUIPMENT TYPE	SIZE CATEGORY (INPUT)	SUBCATEGORY OR RATING CONDITION	MINIMUM EFFICIENCY ^{d, e}	TEST PROCEDURE ^a
Warm-air furnaces, gas fired	< 225,000 Btu/h	—	78% AFUE or 80% E_t^c	DOE 10 CFR Part 430 or ANSI Z21.47
	≥ 225,000 Btu/h	Maximum capacity ^c	80% E_t^f	ANSI Z21.47
Warm-air furnaces, oil fired	< 225,000 Btu/h	—	78% AFUE or 80% E_t^c	DOE 10 CFR Part 430 or UL 727
	≥ 225,000 Btu/h	Maximum capacity ^b	81% E_t^g	UL 727
Warm-air duct furnaces, gas fired	All capacities	Maximum capacity ^b	80% E_c	ANSI Z83.8
Warm-air unit heaters, gas fired	All capacities	Maximum capacity ^b	80% E_c	ANSI Z83.8
Warm-air unit heaters, oil fired	All capacities	Maximum capacity ^b	80% E_c	UL 731

Table 6: IECC 2015 Water Heaters minimum performance (effective 1/1/2016 to 6/30/2019)

EQUIPMENT TYPE	SIZE CATEGORY (input)	SUBCATEGORY OR RATING CONDITION	PERFORMANCE REQUIRED ^{a, b}	TEST PROCEDURE
Water heaters, electric	≤ 12 kW ^d	Resistance	0.97 - 0.00 132V, EF	DOE 10 CFR Part 430
	> 12 kW	Resistance	$(0.3 + 27/V_m)$, %/h	ANSI Z21.10.3
	≤ 24 amps and ≤ 250 volts	Heat pump	0.93 - 0.00 132V, EF	DOE 10 CFR Part 430
Storage water heaters, gas	≤ 75,000 Btu/h	≥ 20 gal	0.67 - 0.0019V, EF	DOE 10 CFR Part 430
	> 75,000 Btu/h and ≤ 155,000 Btu/h	< 4,000 Btu/h/gal	$80\% E_t$ $(Q/800 + 110.\sqrt{V})SL$, Btu/h	ANSI Z21.10.3
	> 155,000 Btu/h	< 4,000 Btu/h/gal	$80\% E_t$ $(Q/800 + 110.\sqrt{V})SL$, Btu/h	
Instantaneous water heaters, gas	> 50,000 Btu/h and < 200,000 Btu/h ^c	≥ 4,000 (Btu/h)/gal and < 2 gal	0.62 - 0.00 19V, EF	DOE 10 CFR Part 430
	≥ 200,000 Btu/h	≥ 4,000 Btu/h/gal and < 10 gal	$80\% E_t$	ANSI Z21.10.3
	≥ 200,000 Btu/h	≥ 4,000 Btu/h/gal and ≥ 10 gal	$80\% E_t$ $(Q/800 + 110.\sqrt{V})SL$, Btu/h	

Table 7: IECC 2018 ASHP Minimum Efficiency Requirements (effective 7/1/2019 to 9/30/2022)

TABLE C403.3.2(2)
MINIMUM EFFICIENCY REQUIREMENTS: ELECTRICALLY OPERATED UNITARY AND APPLIED HEAT PUMPS

EQUIPMENT TYPE	SIZE CATEGORY	HEATING SECTION TYPE	SUBCATEGORY OR RATING CONDITION	MINIMUM EFFICIENCY	TEST PROCEDURE ^a		
Air cooled (cooling mode)	< 65,000 Btu/h ^b	All	Split System	14.0 SEER	AHRI 210/240		
			Single Package	14.0 SEER			
Through-the-wall, air cooled	≤ 30,000 Btu/h ^b	All	Split System	12.0 SEER			
			Single Package	12.0 SEER			
Single-duct high-velocity air cooled	< 65,000 Btu/h ^b	All	Split System	11.0 SEER			
Air cooled (cooling mode)	≥ 65,000 Btu/h and < 135,000 Btu/h	Electric Resistance (or None)	Split System and Single Package	11.0 EER 12.0 IEER		AHRI 340/360	
		All other	Split System and Single Package	10.8 EER 11.8 IEER			
	≥ 135,000 Btu/h and < 240,000 Btu/h	Electric Resistance (or None)	Split System and Single Package	10.6 EER 11.6 IEER			
		All other	Split System and Single Package	10.4 EER 11.4 IEER			
	≥ 240,000 Btu/h	Electric Resistance (or None)	Split System and Single Package	9.5 EER 10.6 IEER			
		All other	Split System and Single Package	9.3 EER 9.4 IEER			
	Water to Air: Water Loop (cooling mode)	< 17,000 Btu/h	All	86°F entering water	12.2 EER		ISO 13256-1
		≥ 17,000 Btu/h and < 65,000 Btu/h	All	86°F entering water	13.0 EER		
≥ 65,000 Btu/h and < 135,000 Btu/h		All	86°F entering water	13.0 EER			
Water to Air: Ground Water (cooling mode)	< 135,000 Btu/h	All	59°F entering water	18.0 EER	ISO 13256-1		
Brine to Air: Ground Loop (cooling mode)	< 135,000 Btu/h	All	77°F entering water	14.1 EER	ISO 13256-1		
Water to Water: Water Loop (cooling mode)	< 135,000 Btu/h	All	86°F entering water	10.6 EER	ISO 13256-2		
Water to Water: Ground Water (cooling mode)	< 135,000 Btu/h	All	59°F entering water	16.3 EER			
Brine to Water: Ground Loop (cooling mode)	< 135,000 Btu/h	All	77°F entering fluid	12.1 EER			

Table 7 continued:

Air cooled (heating mode)	< 65,000 Btu/h ^b	—	Split System	8.2 HSPF	AHRI 210/240
		—	Single Package	8.0 HSPF	
Through-the-wall, (air cooled, heating mode)	≤ 30,000 Btu/h ^b (cooling capacity)	—	Split System	7.4 HSPF	
		—	Single Package	7.4 HSPF	
Small-duct high velocity (air cooled, heating mode)	< 65,000 Btu/h ^b	—	Split System	6.8 HSPF	
Air cooled (heating mode)	≥ 65,000 Btu/h and < 135,000 Btu/h (cooling capacity)	—	47°F db/43°F wb outdoor air	3.3 COP	
			17°Fdb/15°F wb outdoor air	2.25 COP	
	≥ 135,000 Btu/h (cooling capacity)	—	47°F db/43°F wb outdoor air	3.2 COP	
			17°Fdb/15°F wb outdoor air	2.05 COP	
Water to Air: Water Loop (heating mode)	< 135,000 Btu/h (cooling capacity)	—	68°F entering water	4.3 COP	ISO 13256-1
Water to Air: Ground Water (heating mode)	< 135,000 Btu/h (cooling capacity)	—	50°F entering water	3.7 COP	
Brine to Air: Ground Loop (heating mode)	< 135,000 Btu/h (cooling capacity)	—	32°F entering fluid	3.2 COP	
Water to Water: Water Loop (heating mode)	< 135,000 Btu/h (cooling capacity)	—	68°F entering water	3.7 COP	ISO 13256-2
Water to Water: Ground Water (heating mode)	< 135,000 Btu/h (cooling capacity)	—	50°F entering water	3.1 COP	
Brine to Water: Ground Loop (heating mode)	< 135,000 Btu/h (cooling capacity)	—	32°F entering fluid	2.5 COP	

For SI: 1 British thermal unit per hour = 0.2931 W. °C = [(°F) - 32]/1.8.

- a. Chapter 8 contains a complete specification of the referenced test procedure, including the reference year version of the test procedure.
- b. Single-phase, air-cooled heat pumps less than 65,000 Btu/h are regulated by NAECA. SEER and HSPF values are those set by NAECA.

Table 8: IECC 2018 Electric Chillers, Air-Cooled and Water-Cooled minimum efficiencies (effective 7/1/2019 to 9/30/2022)

TABLE C403.3.2(7)
WATER CHILLING PACKAGES — EFFICIENCY REQUIREMENTS^{a, b, d}

EQUIPMENT TYPE	SIZE CATEGORY	UNITS	BEFORE 1/1/2015		AS OF 1/1/2015		TEST PROCEDURE ^c		
			Path A	Path B	Path A	Path B			
Air-cooled chillers	< 150 Tons	EER (Btu/W)	≥ 9.562 FL	NA ^c	≥ 10.100 FL	≥ 9.700 FL	AHRI 550/590		
			≥ 12.500 IPLV		≥ 13.700 IPLV	≥ 15.800 IPLV			
	≥ 150 Tons		≥ 9.562 FL	NA ^c	≥ 10.100 FL	≥ 9.700 FL			
			≥ 12.500 IPLV		≥ 14.000 IPLV	≥ 16.100 IPLV			
Air cooled without condenser, electrically operated	All capacities	EER (Btu/W)	Air-cooled chillers without condenser shall be rated with matching condensers and complying with air-cooled chiller efficiency requirements.						
Water cooled, electrically operated positive displacement	< 75 Tons	kW/ton	≤ 0.780 FL	≤ 0.800 FL	≤ 0.750 FL	≤ 0.780 FL			
			≤ 0.630 IPLV	≤ 0.600 IPLV	≤ 0.600 IPLV	≤ 0.500 IPLV			
	≥ 75 tons and < 150 tons		≤ 0.775 FL	≤ 0.790 FL	≤ 0.720 FL	≤ 0.750 FL			
			≤ 0.615 IPLV	≤ 0.586 IPLV	≤ 0.560 IPLV	≤ 0.490 IPLV			
	≥ 150 tons and < 300 tons		≥ 0.680 FL	≥ 0.718 FL	≥ 0.660 FL	≥ 0.680 FL			
			≥ 0.580 IPLV	≥ 0.540 IPLV	≥ 0.540 IPLV	≥ 0.440 IPLV			
	≥ 300 tons and < 600 tons		≤ 0.620 FL	≤ 0.639 FL	≤ 0.610 FL	≤ 0.625 FL			
			≤ 0.540 IPLV	≤ 0.490 IPLV	≤ 0.520 IPLV	≤ 0.410 IPLV			
	≥ 600 tons		≤ 0.620 FL	≤ 0.639 FL	≤ 0.560 FL	≤ 0.585 FL			
			≤ 0.540 IPLV	≤ 0.490 IPLV	≤ 0.500 IPLV	≤ 0.380 IPLV			
	Water cooled, electrically operated centrifugal		< 150 Tons	kW/ton	≤ 0.634 FL	≤ 0.639 FL	≤ 0.610 FL	≤ 0.695 FL	
					≤ 0.596 IPLV	≤ 0.450 IPLV	≤ 0.550 IPLV	≤ 0.440 IPLV	
≥ 150 tons and < 300 tons		≤ 0.634 FL	≤ 0.639 FL		≤ 0.610 FL	≤ 0.635 FL			
		≤ 0.596 IPLV	≤ 0.450 IPLV		≤ 0.550 IPLV	≤ 0.400 IPLV			
≥ 300 tons and < 400 tons		≤ 0.576 FL	≤ 0.600 FL		≤ 0.560 FL	≤ 0.595 FL			
		≤ 0.549 IPLV	≤ 0.400 IPLV		≤ 0.520 IPLV	≤ 0.390 IPLV			
≥ 400 tons and < 600 tons		≤ 0.576 FL	≤ 0.600 FL		≤ 0.560 FL	≤ 0.585 FL			
		≤ 0.549 IPLV	≤ 0.400 IPLV		≤ 0.500 IPLV	≤ 0.380 IPLV			
≥ 600 Tons		≤ 0.570 FL	≤ 0.590 FL		≤ 0.560 FL	≤ 0.585 FL			
		≤ 0.539 IPLV	≤ 0.400 IPLV		≤ 0.500 IPLV	≤ 0.380 IPLV			
Air cooled, absorption, single effect		All capacities	COP		≥ 0.600 FL	NA ^c	≥ 0.600 FL	NA ^c	AHRI 560
Water cooled absorption, single effect		All capacities	COP		≥ 0.700 FL	NA ^c	≥ 0.700 FL	NA ^c	
Absorption, double effect, indirect fired	All capacities	COP	≥ 1.000 FL	NA ^c	≥ 1.000 FL	NA ^c			
			≥ 1.050 IPLV		≥ 1.050 IPLV				
Absorption double effect direct fired	All capacities	COP	≥ 1.000 FL	NA ^c	≥ 1.000 FL	NA ^c			
			≥ 1.000 IPLV		≥ 1.050 IPLV				

Table 9: IECC 2018 Boiler minimum efficiency requirements (effective 7/1/2019 to 9/30/2022)

Note Code of Federal Regulations for gas -fired hot water boilers manufactured after January 15, 2021 require <300,000Btuh hot water boilers to be 84% AFUE and <300,000 Btuh steam boilers to be 82% AFUE (10 CFR 432(e)(3)). This should be assumed baseline from 1/1/2022.

TABLE C403.3.2(5)
MINIMUM EFFICIENCY REQUIREMENTS: GAS- AND OIL-FIRED BOILERS

EQUIPMENT TYPE ^a	SUBCATEGORY OR RATING CONDITION	SIZE CATEGORY (INPUT)	MINIMUM EFFICIENCY ^{d, e}	TEST PROCEDURE
Boilers, hot water	Gas-fired	< 300,000 Btu/h ^{f, g}	82% AFUE	10 CFR Part 430
		≥ 300,000 Btu/h and ≤ 2,500,000 Btu/h ^b	80% E _t	10 CFR Part 431
		> 2,500,000 Btu/h ^a	82% E _c	
	Oil-fired ^c	< 300,000 Btu/h ^g	84% AFUE	10 CFR Part 430
		≥ 300,000 Btu/h and ≤ 2,500,000 Btu/h ^b	82% E _t	10 CFR Part 431
		> 2,500,000 Btu/h ^a	84% E _c	
Boilers, steam	Gas-fired	< 300,000 Btu/h ^f	80% AFUE	10 CFR Part 430
	Gas-fired- all, except natural draft	≥ 300,000 Btu/h and ≤ 2,500,000 Btu/h ^b	79% E _t	10 CFR Part 431
		> 2,500,000 Btu/h ^a	79% E _t	
	Gas-fired-natural draft	≥ 300,000 Btu/h and ≤ 2,500,000 Btu/h ^b	77% E _t	
		> 2,500,000 Btu/h ^a	77% E _t	
	Oil-fired ^c	< 300,000 Btu/h	82% AFUE	10 CFR Part 430
		≥ 300,000 Btu/h and ≤ 2,500,000 Btu/h ^b	81% E _t	10 CFR Part 431
		> 2,500,000 Btu/h ^a	81% E _t	

Table 10: IECC 2018 Warm-air Furnace minimum efficiency standards (effective 7/1/2019 to 9/30/2022)

TABLE C403.3.2(4)
WARM-AIR FURNACES AND COMBINATION WARM-AIR FURNACES/AIR-CONDITIONING UNITS, WARM-AIR DUCT FURNACES AND UNIT HEATERS, MINIMUM EFFICIENCY REQUIREMENTS

EQUIPMENT TYPE	SIZE CATEGORY (INPUT)	SUBCATEGORY OR RATING CONDITION	MINIMUM EFFICIENCY ^{d, e}	TEST PROCEDURE ^a
Warm-air furnaces, gas fired	< 225,000 Btu/h	—	80% AFUE or 80%E _t	DOE 10 CFR Part 430 or ANSI Z21.47
	≥ 225,000 Btu/h	Maximum capacity ^c	80%E _t ^f	ANSI Z21.47
Warm-air furnaces, oil fired	< 225,000 Btu/h	—	83% AFUE or 80%E _t	DOE 10 CFR Part 430 or UL 727
	≥ 225,000 Btu/h	Maximum capacity ^b	81%E _t ^g	UL 727
Warm-air duct furnaces, gas fired	All capacities	Maximum capacity ^b	80%E _c	ANSI Z83.8
Warm-air unit heaters, gas fired	All capacities	Maximum capacity ^b	80%E _c	ANSI Z83.8
Warm-air unit heaters, oil fired	All capacities	Maximum capacity ^b	80%E _c	UL 731

Table 11: IECC 2018 Water Heaters minimum performance (effective 7/1/2019 to 9/30/2022)

TABLE C404.2
MINIMUM PERFORMANCE OF WATER-HEATING EQUIPMENT

EQUIPMENT TYPE	SIZE CATEGORY (input)	SUBCATEGORY OR RATING CONDITION	PERFORMANCE REQUIRED ^{a, b}	TEST PROCEDURE
Water heaters, electric	≤ 12 kW ^d	Tabletop ^e , ≥ 20 gallons and ≤ 120 gallons	0.93 - 0.00132V, EF	DOE 10 CFR Part 430
		Resistance ≥ 20 gallons and ≤ 55 gallons	0.960 - 0.0003V, EF	
		Grid-enabled ^f > 75 gallons and ≤ 120 gallons	1.061 - 0.00168V, EF	
	> 12 kW	Resistance	(0.3 + 27/V _m), %/h	ANSI Z21.10.3
	≤ 24 amps and ≤ 250 volts	Heat pump > 55 gallons and ≤ 120 gallons	2.057 - 0.00113V, EF	DOE 10 CFR Part 430
Storage water heaters, gas	≤ 75,000 Btu/h	≥ 20 gallons and > 55 gallons	0.675 - 0.0015V, EF	DOE 10 CFR Part 430
		> 55 gallons and ≤ 100 gallons	0.8012 - 0.00078V, EF	
	> 75,000 Btu/h and ≤ 155,000 Btu/h	< 4,000 Btu/h/gal	80% E _t	ANSI Z21.10.3
	> 155,000 Btu/h	< 4,000 Btu/h/gal	80% E _t	
Instantaneous water heaters, gas	> 50,000 Btu/h and < 200,000 Btu/h ^c	≥ 4,000 (Btu/h)/gal and < 2 gal	0.82 - 0.00 19V, EF	DOE 10 CFR Part 430
	≥ 200,000 Btu/h	≥ 4,000 Btu/h/gal and < 10 gal	80% E _t	ANSI Z21.10.3
	≥ 200,000 Btu/h	≥ 4,000 Btu/h/gal and ≥ 10 gal	80% E _t	

Table 12: IECC 2021 ASHP Minimum Efficiency Requirements (expected to become effective statewide in 2023)

TABLE C403.3.2(2)
ELECTRICALLY OPERATED AIR-COOLED UNITARY HEAT PUMPS—MINIMUM EFFICIENCY REQUIREMENTS^{a, d}

EQUIPMENT TYPE	SIZE CATEGORY	HEADING SECTION TYPE	SUBCATEGORY OR RATING CONDITION	MINIMUM EFFICIENCY	TEST PROCEDURE ^e
Air cooled (cooling mode)	< 66,000 Btu/h	All	Split system, three phase and applications outside US single phase ^b	14.0 SEER before 1/1/2023 14.3 SEER2 after 1/1/2023	AHRI 210/240—2017 before 1/1/2023 AHRI 210/240—2023 after 1/1/2023
			Single package, three phase and applications outside US single phase ^b	14.0 SEER before 1/1/2023 13.4 SEER2 after 1/1/2023	
Space constrained, air cooled (cooling mode)	≤ 30,000 Btu/h	All	Split system, three phase and applications outside US single phase ^b	12.0 SEER before 1/1/2023 11.7 SEER2 after 1/1/2023	AHRI 210/240—2017 before 1/1/2023 AHRI 210/240—2023 after 1/1/2023
			Single package, three phase and applications outside US single phase ^b	12.0 SEER before 1/1/2023 11.7 SEER2 after 1/1/2023	
Single duct, high velocity, air cooled (cooling mode)	< 65,000	All	Split system, three phase and applications outside US single phase ^b	12.0 SEER before 1/1/2023 12.0 SEER2 after 1/1/2023	AHRI 210/240—2017 before 1/1/2023 AHRI 210/240—2023 after 1/1/2023
Air cooled (cooling mode)	≥ 65,000 Btu/h and < 135,000 Btu/h	Electric resistance (or none)	Split system and single package	11.0 EER 12.2 IEER before 1/1/2023 14.1 IEER after 1/1/2023	AHRI 340/360
		All other		10.8 EER 12.0 IEER before 1/1/2023 13.9 IEER after 1/1/2023	
	≥ 135,000 Btu/h and < 240,000 Btu/h	Electric resistance (or none)		10.6 EER 11.6 IEER before 1/1/2023 13.5 IEER after 1/1/2023	
		All other		10.4 EER 11.4 IEER before 1/1/2023 13.3 IEER after 1/1/2023	
	≥ 240,000 Btu/h	Electric resistance (or none)		9.5 EER 10.6 IEER before 1/1/2023 12.5 IEER after 1/1/2023	
		All other		9.3 EER 10.4 IEER before 1/1/2023 12.3 IEER after 1/1/2023	
Air cooled (heating mode)	< 65,000 Btu/h	All	Split system, three phase and applications outside US single phase ^b	8.2 HSPF before 1/1/2023 7.5 HSPF2 after 1/1/2023	AHRI 210/240—2017 before 1/1/2023 AHRI 210/240—2023 after 1/1/2023
			Single package, three phase and applications outside US single phase ^b	8.0 HSPF before 1/1/2023 6.7 HSPF2 after 1/1/2023	

Table 12 continued:

TABLE C403.3.2(2)—continued
ELECTRICALLY OPERATED AIR-COOLED UNITARY HEAT PUMPS—MINIMUM EFFICIENCY REQUIREMENTS^{a, d}

EQUIPMENT TYPE	SIZE CATEGORY	HEADING SECTION TYPE	SUBCATEGORY OR RATING CONDITION	MINIMUM EFFICIENCY	TEST PROCEDURE ^a
Space constrained, air cooled (heating mode)	≤ 30,000 Btu/h	All	Split system, three phase and applications outside US single phase ^b	7.4 HSPF before 1/1/2023 6.3 HSPF2 after 1/1/2023	AHRI 210/240—2017 before 1/1/2023 AHRI 210/240—2023 after 1/1/2023
			Single package, three phase and applications outside US single phase ^b	7.4 HSPF before 1/1/2023 6.3 HSPF2 after 1/1/2023	
Small duct, high velocity, air cooled (heating mode)	< 65,000 Btu/h	All	Split system, three phase and applications outside US single phase ^b	7.2 HSPF before 1/1/2023 6.1 HSPF2 after 1/1/2023	AHRI 210/240—2017 before 1/1/2023 AHRI 210/240—2023 after 1/1/2023
Air cooled (heating mode)	≥ 65,000 Btu/h and < 135,000 Btu/h (cooling capacity)	All	47°F db/43°F wb outdoor air	3.30 COP _H before 1/1/2023 3.40 COP _H after 1/1/2023	AHRI 340/360
			17°F db/15°F wb outdoor air	2.25 COP _H	
	47°F db/43°F wb outdoor air		3.20 COP _H before 1/1/2023 3.30 SOP _H after 1/1/2023		
	17°F db/15°F wb outdoor air		2.05 COP _H		
	47°F db/43°F wb outdoor air		3.20 COP _H		
	17°F db/15°F wb outdoor air		2.05 COP _H		
≥ 135,000 Btu/h and < 240,000 Btu/h (cooling capacity)	≥ 240,000 Btu/h (cooling capacity)				

Table 13: IECC 2021 Electric Chillers, Air-Cooled and Water-Cooled minimum efficiencies (expected to become effective statewide in 2023)

TABLE C403.3.2(3)
WATER-CHILLING PACKAGES—MINIMUM EFFICIENCY REQUIREMENTS^{a, b, e, f}

EQUIPMENT TYPE	SIZE CATEGORY	UNITS	PATH A	PATH B	TEST PROCEDURE ^e
Air cooled chillers	< 150 tons	EER (Btu/Wh)	≥ 10.100 FL	≥ 9.700 FL	AHRI 550/590
			≥ 13.700 IPLV.IP	≥ 15.800 IPLV.IP	
	≥ 150 tons		≥ 10.100 FL	≥ 9.700FL	
			≥ 14.000 IPLV.IP	≥ 16.100 IPLV.IP	
Air cooled without condenser, electrically operated	All capacities	EER (Btu/Wh)	Air-cooled chillers without condenser must be rated with matching condensers and comply with air-cooled chiller efficiency requirements		AHRI 550/590
Water cooled, electrically operated positive displacement	< 75 tons	kW/ton	≤ 0.750 FL	≤ 0.780 FL	AHRI 550/590
			≤ 0.600 IPLV.IP	≤ 0.500 IPLV.IP	
	≥ 75 tons and < 150 tons		≤ 0.720 FL	≤ 0.750 FL	
			≤ 0.560 IPLV.IP	≤ 0.490 IPLV.IP	
	≥ 150 tons and < 300 tons		≤ 0.660 FL	≤ 0.680 FL	
			≤ 0.540 IPLV.IP	≤ 0.440 IPLV.IP	
	≥ 300 tons and < 600 tons		≤ 0.610 FL	≤ 0.625 FL	
			≤ 0.520 IPLV.IP	≤ 0.410 IPLV.IP	
≥ 600 tons	≤ 0.560 FL	≤ 0.585 FL			
≤ 0.500 IPLV.IP	≤ 0.380 IPLV.IP				
Water cooled, electrically operated centrifugal	< 150 tons	kW/ton	≤ 0.610 FL	≤ 0.695 FL	AHRI 550/590
			≤ 0.550 IPLV.IP	≤ 0.440 IPLV.IP	
	≥ 300 tons and < 400 tons		≤ 0.610 FL	≤ 0.635 FL	
			≤ 0.550 IPLV.IP	≤ 0.400 IPLV.IP	
	≥ 400 tons and < 600 tons		≤ 0.560 FL	≤ 0.595 FL	
			≤ 0.520 IPLV.IP	≤ 0.390 IPLV.IP	
	≥ 600 tons		≤ 0.560 FL	≤ 0.585 FL	
			≤ 0.500 IPLV.IP	≤ 0.380 IPLV.IP	
≥ 600 tons	≤ 0.560 FL	≤ 0.585 FL			
≤ 0.500 IPLV.IP	≤ 0.380 IPLV.IP				
Air cooled absorption, single effect	All capacities	COP (W/W)	≥ 0.600 FL	NA ^d	AHRI 560
Water cooled absorption, single effect	All capacities	COP (W/W)	≥ 0.700 FL	NA ^d	AHRI 560
Absorption double effect, indirect fired	All capacities	COP (W/W)	≥ 1.000 FL	NA ^d	AHRI 560
			≥ 0.150 IPLV.IP		
Absorption double effect, direct fired	All capacities	COP (W/W)	≥ 1.000 FL	NA ^d	AHRI 560
			≥ 1.000 IPLV		

- a. Chapter 6 contains a complete specification of the referenced standards, which include test procedures, including the reference year version of the test procedure.
- b. The requirements for centrifugal chillers shall be adjusted for nonstandard rating conditions per Section C403.3.2.1 and are applicable only for the range of conditions listed there. The requirements for air-cooled, water-cooled positive displacement and absorption chillers are at standard rating conditions defined in the reference test procedure.
- c. Both the full-load and IPLV.IP requirements must be met or exceeded to comply with this standard. When there is a Path B, compliance can be with either Path A or Path B for any application.
- d. NA means the requirements are not applicable for Path B, and only Path A can be used for compliance.
- e. FL is the full-load performance requirements, and IPLV.IP is for the part-load performance requirements.
- f. This table is a replica of ASHRAE 90.1 Table 6.8.1-3 Water-Chilling Packages—Minimum Efficiency Requirements.

Table 14: IECC 2021 Boiler minimum efficiency requirements (expected to become effective statewide in 2023)

Note Code of Federal Regulations for gas -fired hot water boilers manufactured after January 15, 2021 require <300,000 Btuh hot water boilers to be 84% AFUE and <300,000 Btuh steam boilers to be 82% AFUE (10 CFR 432(e)(3)). This should be assumed baseline from 1/1/2022.

TABLE C403.3.2(6)
GAS- AND OIL-FIRED BOILERS—MINIMUM EFFICIENCY REQUIREMENTS¹

EQUIPMENT TYPE ^b	SUBCATEGORY OR RATING CONDITION	SIZE CATEGORY (INPUT)	MINIMUM EFFICIENCY	EFFICIENCY AS OF 3/2/2022	TEST PROCEDURE ^a
Boilers, hot water	Gas fired	< 300,000 Btu/h ^{e, h} for applications outside US	82% AFUE	82% AFUE	DOE 10 CFR 430 Appendix N
		≥ 300,000 Btu/h and ≤ 2,500,000 Btu/h ^e	80% E_t^d	80% E_t^d	DOE 10 CFR 431.86
		> 2,500,000 Btu/h ^b	82% E_c^c	82% E_c^c	
	Oil fired ^f	< 300,000 Btu/h ^{e, h} for applications outside US	84% AFUE	84% AFUE	DOE 10 CFR 430 Appendix N
		≥ 300,000 Btu/h and ≤ 2,500,000 Btu/h ^e	82% E_t^d	82% E_t^d	DOE 10 CFR 431.86
		> 2,500,000 Btu/h ^b	84% E_c^c	84% E_c^c	
Boilers, steam	Gas fired	< 300,000 Btu/h ^e for applications outside US	80% AFUE	80% AFUE	DOE 10 CFR 430 Appendix N
	Gas fired—all, except natural draft	≥ 300,000 Btu/h and ≤ 2,500,000 Btu/h ^e	79% E_t^d	79% E_t^d	DOE 10 CFR 431.86
		> 2,500,000 Btu/h ^b	79% E_t^d	79% E_t^d	
	Gas fired—natural draft	≥ 300,000 Btu/h and ≤ 2,500,000 Btu/h ^e	77% E_t^d	79% E_t^d	
		> 2,500,000 Btu/h ^b	77% E_t^d	79% E_t^d	
	Oil fired ^f	< 300,000 Btu/h ^e for applications outside US	82% AFUE	82% AFUE	DOE 10 CFR 430 Appendix N
		≥ 300,000 Btu/h and ≤ 2,500,000 Btu/h ^e	81% E_t^d	81% E_t^d	DOE 10 CFR 431.86
> 2,500,000 Btu/h ^b		81% E_t^d	81% E_t^d		

Table 15: IECC 2021 Warm-air Furnace minimum efficiency standards (expected to become effective statewide in 2023)

TABLE C403.3.2(5)
 WARM-AIR FURNACES AND COMBINATION WARM-AIR FURNACES/AIR-CONDITIONING UNITS,
 WARM-AIR DUCT FURNACES AND UNIT HEATERS—MINIMUM EFFICIENCY REQUIREMENTS^a

EQUIPMENT TYPE	SIZE CATEGORY (INPUT)	SUBCATEGORY OR RATING CONDITION	MINIMUM EFFICIENCY	TEST PROCEDURE ^a
Warm-air furnace, gas fired for application outside the US	< 225,000 Btu/h	Maximum capacity ^c	80% AFUE (nonweatherized) or 81% AFUE (weatherized) or 80% $E_t^{b,d}$	DOE 10 CFR 430 Appendix N or Section 2.39, Thermal Efficiency, ANSI Z21.47
Warm-air furnace, gas fired	< 225,000 Btu/h	Maximum capacity ^c	80% $E_t^{b,d}$ before 1/1/2023 81% E_t^d after 1/1/2023	Section 2.39, Thermal Efficiency, ANSI Z21.47
Warm-air furnace, oil fired for application outside the US	< 225,000 Btu/h	Maximum capacity ^c	83% AFUE (nonweatherized) or 78% AFUE (weatherized) or 80% $E_t^{b,d}$	DOE 10 CFR 430 Appendix N or Section 42, Combustion, UL 727
Warm-air furnace, oil fired	< 225,000 Btu/h	Maximum capacity ^c	80% E_t before 1/1/2023 82% E_t^d after 1/1/2023	Section 42, Combustion, UL 727
Electric furnaces for applications outside the US	< 225,000 Btu/h	All	96% AFUE	DOE 10 CFR 430 Appendix N
Warm-air duct furnaces, gas fired	All capacities	Maximum capacity ^c	80% E_c^e	Section 2.10, Efficiency, ANSI Z83.8
Warm-air unit heaters, gas fired	All capacities	Maximum capacity ^c	80% $E_c^{e,f}$	Section 2.10, Efficiency, ANSI Z83.8
Warm-air unit heaters, oil fired	All capacities	Maximum capacity ^c	80% $E_c^{e,f}$	Section 40, Combustion, UL 731

Table 16: IECC 2021 Water Heaters minimum performance (expected to become effective statewide in 2023)

**TABLE C404.2
MINIMUM PERFORMANCE OF WATER-HEATING EQUIPMENT**

EQUIPMENT TYPE	SIZE CATEGORY (input)	SUBCATEGORY OR RATING CONDITION	PERFORMANCE REQUIRED ^{a, b}	TEST PROCEDURE
Water heaters, electric	≤ 12 kW ^d	Tabletop ^e , ≥ 20 gallons and ≤ 120 gallons	0.93 – 0.00132V, EF	DOE 10 CFR Part 430
		Resistance ≥ 20 gallons and ≤ 55 gallons	0.960 – 0.0003V, EF	
		Grid-enabled ^f > 75 gallons and ≤ 120 gallons	1.061 – 0.00168V, EF	
	> 12 kW	Resistance	(0.3 + 27/V _m), %/h	ANSI Z21.10.3
	≤ 24 amps and ≤ 250 volts	Heat pump > 55 gallons and ≤ 120 gallons	2.057 – 0.00113V, EF	DOE 10 CFR Part 430
Storage water heaters, gas	≤ 75,000 Btu/h	≥ 20 gallons and ≤ 55 gallons	0.675 – 0.0015V, EF	DOE 10 CFR Part 430
		> 55 gallons and ≤ 100 gallons	0.8012 – 0.00078V, EF	
	> 75,000 Btu/h and ≤ 155,000 Btu/h	< 4,000 Btu/h/gal	80% E _t (Q/800 + 110.√V̇)SL, Btu/h	ANSI Z21.10.3
> 155,000 Btu/h	< 4,000 Btu/h/gal	80% E _t (Q/800 + 110.√V̇)SL, Btu/h		
Instantaneous water heaters, gas	> 50,000 Btu/h and < 200,000 Btu/h ^e	≥ 4,000 Btu/h/gal and < 2 gal	0.82 – 0.0019V, EF	DOE 10 CFR Part 430
	≥ 200,000 Btu/h	≥ 4,000 Btu/h/gal and < 10 gal	80% E _t	ANSI Z21.10.3
	≥ 200,000 Btu/h	≥ 4,000 Btu/h/gal and ≥ 10 gal	80% E _t (Q/800 + 110.√V̇)SL, Btu/h	
Storage water heaters, oil	≤ 105,000 Btu/h	≥ 20 gal and ≤ 50 gallons	0.68 – 0.0019V, EF	DOE 10 CFR Part 430
	≥ 105,000 Btu/h	< 4,000 Btu/h/gal	80% E _t (Q/800 + 110.√V̇)SL, Btu/h	ANSI Z21.10.3
Instantaneous water heaters, oil	≤ 210,000 Btu/h	≥ 4,000 Btu/h/gal and < 2 gal	0.59 – 0.0019V, EF	DOE 10 CFR Part 430
	> 210,000 Btu/h	≥ 4,000 Btu/h/gal and < 10 gal	80% E _t	ANSI Z21.10.3
	> 210,000 Btu/h	≥ 4,000 Btu/h/gal and ≥ 10 gal	78% E _t (Q/800 + 110.√V̇)SL, Btu/h	
Hot water supply boilers, gas and oil	≥ 300,000 Btu/h and < 12,500,000 Btu/h	≥ 4,000 Btu/h/gal and < 10 gal	80% E _t	ANSI Z21.10.3
Hot water supply boilers, gas	≥ 300,000 Btu/h and < 12,500,000 Btu/h	≥ 4,000 Btu/h/gal and ≥ 10 gal	80% E _t (Q/800 + 110.√V̇)SL, Btu/h	
Hot water supply boilers, oil	> 300,000 Btu/h and < 12,500,000 Btu/h	> 4,000 Btu/h/gal and > 10 gal	78% E _t (Q/800 + 110.√V̇)SL, Btu/h	

Time of Sale: The baseline for this measure is a new replacement unit of the same system type as the existing unit, meeting the minimum standard efficiencies provided above.

Early replacement / Retrofit: The baseline for this measure is the efficiency of the *existing* heating, cooling and hot water equipment for the assumed remaining useful life of the existing unit, and a new baseline heating and cooling system for the remainder of the measure life (as provided in table above).

DEEMED LIFETIME OF EFFICIENT EQUIPMENT

The expected measure life of the ground source heat pump is assumed to be 25 years.⁹⁷⁷

The expected measure life of the ground loop field is assumed to be 50 years.⁹⁷⁸

For early replacement, the remaining life of existing equipment is assumed to be 6 years for ASHP and Central AC, 7 years for furnace, 8 years for boilers and GSHP,⁹⁷⁹ and 25 years for electric resistance.⁹⁸⁰

DEEMED MEASURE COST

New Construction and Time of Sale: Incremental costs of the Ground Source Heat Pump should be used. This would be the actual installed cost of the Ground Source Heat Pump, well drilling, building retrofit, and system commissioning costs (default of \$10,923/ton),⁹⁸¹ minus the assumed installation cost of the baseline equipment (\$6562 + \$600 for ASHP,⁹⁸² or \$12.43/kBtu capacity for a new baseline efficient furnace or \$19.33/kBtu capacity for a new efficient steam boiler or \$21.27/kBtu capacity for a new efficient hot water boiler,⁹⁸³ and \$1,539/ton for new baseline chiller replacement⁹⁸⁴).

Early Replacement: The actual installed cost of the Ground Source Heat Pump should be used (default cost for total system retrofit provided above). The assumed deferred cost (after 8 years) of replacing existing equipment with a new baseline unit is assumed to be \$7,527 + \$688 for a new baseline Air Source Heat Pump, or \$12.43/kBtu capacity for a new baseline efficient furnace or \$19.33/kBtu capacity for a new efficient steam boiler or \$21.27/kBtu capacity for a new efficient hot water boiler and \$1,539/ton for new baseline chiller replacement. This future cost should be discounted to present value using the nominal societal discount rate.

LOADSHAPE

Loadshape C04 – Commercial Electric Heating (if replacing building with no existing cooling)

Loadshape C05 - Commercial Electric Heating and Cooling

Note for the purpose of cost effectiveness screening for a fuel switch scenario, the heating kWh increase and cooling kWh decrease should be calculated separately such that the appropriate loadshape (i.e., Loadshape C04 - Commercial Electric Heating and Loadshape C03 – Commercial Cooling respectively) can be applied.

COINCIDENCE FACTOR

The summer peak coincidence factor for cooling is provided in two different ways below. The first is used to estimate peak savings during the utility peak hour and is most indicative of actual peak benefits, and the second represents the *average* savings over the defined summer peak period and is presented so that savings can be bid into PJM's

⁹⁷⁷ System life of indoor components as per US DOE estimates from the Office of Energy Efficiency & Renewable Energy. The ground loop has a much longer life, but the compressor and other mechanical components are the same as an ASHP.

⁹⁷⁸ U.S. DOE Office of Energy Efficiency & Renewable Energy, Energy Saver details and descriptions for Geothermal Heat Pumps

⁹⁷⁹ Assumed to be one third of effective useful life of replaced equipment.

⁹⁸⁰ Assume full measure life (16 years) for replacing electric resistance as we would not expect that resistance heat would fail during the lifetime of the efficient measure.

⁹⁸¹ Average calculated based on reviewing cost information received from Chicagoland GSHP installers.

⁹⁸² Assumed consistent with Residential assumptions - Full install ASHP costs are based upon data provided by Ameren. See 'ASHP Costs_06242022'.

⁹⁸³ Average calculated based on RSMMeans Mechanical Cost Data 2015.

⁹⁸⁴ Average calculated based on RSMMeans Mechanical Cost Data 2015 for Scroll, air cooled condenser chillers.

capacity market. Both values provided are based on analysis of Itron eShape data for Missouri, calibrated to Illinois loads, supplied by Ameren.

$$\begin{aligned} CF_{SSP} &= \text{Summer System Peak Coincidence Factor for Commercial cooling (during system peak hour)} \\ &= 91.3\% \text{ }^{985} \end{aligned}$$

$$\begin{aligned} CF_{PJM} &= \text{PJM Summer Peak Coincidence Factor for Commercial cooling (average during peak period)} \\ &= 47.8\% \text{ }^{986} \end{aligned}$$

Algorithm

CALCULATION OF ENERGY SAVINGS

ELECTRIC ENERGY SAVINGS AND FOSSIL FUEL SAVINGS

Non-fuel switch measures:

$$\Delta kWh = [\text{Cooling savings}] + [\text{Heating savings}] + [\text{DHW savings}]$$

$$\text{Cooling Savings} = (\text{Capacity}_{\text{cool}} * EFLH_{\text{Cool}} * (1/EER2_{\text{base}} - 1/EER2_{\text{GSHP}}))/1000$$

$$\text{Heating Savings} = (\text{Capacity}_{\text{Heat}} * EFLH_{\text{Heat}} * (1/HSPF2_{\text{base}} - 1/(COP_{\text{GSHP}} * 3.412)))/1000$$

$$\text{DHW Savings} = \text{Elec}_{\text{DHW}} * (\% \text{DHW} * ((1/EF_{\text{Elecbase}}) * \text{HotWaterUse}_{\text{Gallon}} * \gamma_{\text{Water}} * (T_{\text{out}} - T_{\text{in}}) * 1/3412))$$

Fuel switch measures:

Fuel switch measures must produce positive total lifecycle energy savings (i.e., reduction in Btus at the premises) in order to qualify. This is determined as follows (note for early replacement measures the lifetime savings should be calculated by calculating savings for the remaining useful life of the existing equipment and for the remaining measure life):

$$\text{SiteEnergySavings (MMBTUs)} = \text{FuelSwitchSavings} + \text{NonFuelSwitchSavings}$$

$$\text{FuelSwitchSavings} = \text{GasHeatReplaced} - \text{GSHPSiteHeatConsumed}$$

$$\text{NonFuelSwitchSavings} = \text{FurnaceFanSavings} + \text{GSHPSiteCoolingImpact} + \text{GSHPSiteWaterImpact}$$

$$\text{GasHeatReplaced} = (\text{HeatLoad} * 1/\text{AFUE}_{\text{base}}) / 1,000,000$$

$$\text{FurnaceFanSavings} = (\text{FurnaceFlag} * \text{HeatLoad} * 1/\text{AFUE}_{\text{base}} * F_e) / 1,000,000$$

$$\text{GSHPSiteHeatConsumed} = (\text{HeatLoad} * 1/\text{COP}_{\text{GSHP}}) / 1,000,000$$

$$\text{GSHPSiteCoolingImpact} = (EFLH_{\text{cool}} * \text{Capacity}_{\text{Cool}} * (1/EER2_{\text{base}} - 1/EER2_{\text{GSHP}})/1000 * 3412) / 1,000,000$$

$$\text{GSHPSiteWaterImpact}_{\text{Gas}} = (\% \text{DHWD}_{\text{Displaced}} * ((1/EF_{\text{Gas}} * \text{GPD} * \text{Household} * 365.25 * \gamma_{\text{Water}} * (T_{\text{OUT}} - T_{\text{IN}}) * 1.0) / 1,000,000$$

$$\text{GSHPSiteWaterImpact}_{\text{Electric}} = (\% \text{DHWD}_{\text{Displaced}} * ((1/EF_{\text{Elec}} * \text{GPD} * \text{Household} * 365.25 * \gamma_{\text{Water}} * (T_{\text{OUT}} - T_{\text{IN}}) * 1.0) / 1,000,000$$

If SiteEnergySavings calculated above is positive, the measure is eligible.

⁹⁸⁵ Based on analysis of Itron eShape data for Missouri, calibrated to Illinois loads, supplied by Ameren. The AC load during the utility's peak hour is divided by the maximum AC load during the year.

⁹⁸⁶ Based on analysis of Itron eShape data for Missouri, calibrated to Illinois loads, supplied by Ameren. The average AC load over the PJM peak period (1-5pm, M-F, June through August) is divided by the maximum AC load during the year.

The appropriate savings claim is dependent on which utilities are supporting the measure as provided in a table below:

Measure supported by:	Electric Utility claims (kWh):	Gas Utility claims (therms):
Electric utility only	SiteEnergySavings * 1,000,000/3,412	N/A
Electric and gas utility (Note utilities may make alternative agreements to how savings are allocated as long as total MMBtu savings remains the same).	%IncentiveElectric * SiteEnergySavings * 1,000,000/3,412	%IncentiveGas * SiteEnergySavings * 10
Gas utility only	N/A	SiteEnergySavings * 10

Note for Early Replacement measures, the efficiency terms of the existing unit should be used for the remaining useful life of the existing equipment (6 years for ASHP and Central AC, 6 years for furnace, 8 years for boilers or GSHP, 15 years for electric resistance), and the efficiency terms for a new baseline unit should be used for the remaining years of the measure. See assumptions below.

Where:

Capacity_{cool} = Cooling Output Capacity of Ground Source Heat Pump (Btu/hr)
= Actual installed

EFLH_{cool} = Cooling Equivalent Full Load Hours
Dependent on building type and Existing Buildings or New Construction, provided in section 4.4 HVAC End Use

EER2_{Base} = Energy Efficiency Ratio (EER2) of existing cooling unit (kBtu/hr / kW).
For early replacement, use actual EER2 rating for the remaining useful life of the existing equipment (6 years for ASHP and Central AC, 8 years for GSHP). If EER2 unknown but SEER2 available, convert using the equation:⁹⁸⁷ $EER2_{exist} = (-0.02 * SEER2_{exist}^2) + (1.12 * SEER2_{exist})$.

For TOS, NC, and the remaining measure life of early replacement, use minimum standard efficiencies as specified in tables in 'Definition of Baseline Equipment' section.

EER2_{GSHP} = Part Load Energy Efficiency Ratio efficiency of efficient GSHP unit⁹⁸⁸
= Actual installed

HeatLoad = Calculated heat load for the building
= EFLH_{Heat} * Capacity_{Heat}

Capacity_{Heat} = Heating Output Capacity of Ground Source Heat Pump (Btu/hr)
= Actual installed

EFLH_{Heat} = Heating Equivalent Full Load Hours of heat pump
Dependent on building type and Existing Buildings or New Construction, provided in section 4.4 HVAC End Use

HSPF2_{Base} = Heating System Performance Factor of baseline electric heating system (kBtu/kWh)

⁹⁸⁷ From Wassmer, M. (2003). A Component-Based Model for Residential Air Conditioner and Heat Pump Energy Calculations. Masters Thesis, University of Colorado at Boulder.

⁹⁸⁸ From Res GSHP measure of the IL-TRM: As per conversations with David Buss territory manager for Connor Co, the EER rating of an ASHP equate most appropriately with the full load EER of a GSHP.

For early replacement, use actual HSPF2 rating for the remaining useful life of the existing equipment (6 years for ASHP and Central AC, 8 years for GSHP or 15 years for electric resistance). For electric resistance, assume 3.41.⁹⁸⁹

For TOS, NC, and the remaining measure life of early replacement, use minimum standard efficiencies as specified in tables in ‘Definition of Baseline Equipment’ section.

- COP_{GSHP} = Part Load Coefficient of Performance of efficient GSHP⁹⁹⁰
= Actual installed
- 3.412 = Constant to convert the COP of the unit to the Heating Season Performance Factor (HSPF)
- Ele_{CDHW} = 1 if building has electric DHW
= 0 if building has non electric DHW
= 0 if one to one replacement of existing Ground Source Heat Pump
- %DHW = Percentage of total DHW load that the GSHP will provide
= Actual if known
= If unknown and if desuperheater installed, assume 44%⁹⁹¹
= 0% if no desuperheater installed
- EF_{elecbase} = Energy Factor of baseline electric DHW
= Actual. If unknown or for new construction, assume federal standard as defined in applicable table in ‘Definition of Baseline Equipment’ section.
- HotWaterUse_{Gallon} = Estimated annual hot water consumption (gallons)
= Actual if possible to provide reasonable custom estimate. If not, two methodologies are provided to develop an estimate:
 1. Consumption per usable storage tank capacity
= Capacity * Consumption/cap

Where:

Capacity = Usable capacity of hot water storage tank in gallons
= Actual

Consumption/cap = Estimate of consumption per gallon of usable tank capacity, based on building type:⁹⁹²

Building Type ⁹⁹³	Consumption/Cap
Convenience	528
Education	568
Grocery	528

⁹⁸⁹ Electric resistance has a COP of 1.0 which equals 1/0.293 = 3.41 HSPF.

⁹⁹⁰ As per Res GSHP measure.

⁹⁹¹ Assumes that the desuperheater can provide two thirds of hot water needs for eight months of the year (2/3 * 2/3 = 44%).

Based on input from Doug Dougherty, Geothermal Exchange Organization.

⁹⁹² Methodology based on Cadmus analysis. Annual hot water usage in gallons based on CBECS (2012) and RECS (2009) consumption data of East North Central (removed outliers of 1,000 kBtu/h or less) to calculate hot water usage. Annual hot water gallons per tank size gallons based on the tank sizing methodology found in ASHRAE 2011 HVAC Applications. Chapter 50 Service Water Heating. Demand assumptions (gallons per day) for each building type based on ASHRAE Chapter 50 and to LBNL White Paper. LBL-37398 Technology Data Characterizing Water Heating in Commercial Buildings: Application to End Use Forecasting. Assumes hot water heater efficiency of 80%.

⁹⁹³ According to CBECS 2012 “Lodging” buildings include Dormitories, Hotels, Motel or Inns and other Lodging and “Nursing” buildings include Assisted Living and Nursing Homes.

Building Type ⁹⁹³	Consumption/Cap
Health	788
Large Office	511
Large Retail	528
Lodging	715
Other Commercial	341
Restaurant	622
Small Office	511
Small Retail	528
Warehouse	341
Nursing	672
Multi-Family	894

2. Consumption per unit area by building type
 = (Area/1000) * Consumption/1,000 sq.ft.

Where:

Area = Area in sq.ft that is served by DHW boiler
 = Actual

Consumption/1,000 sq.ft. = Estimate of DHW consumption per 1,000 sq.ft. based on building type.⁹⁹⁴

Building Type ⁹⁹⁵	Consumption/1,000 sq.ft.
Convenience	4,594
Education	7,285
Grocery	697
Health	24,540
Large Office	1,818
Large Retail	1,354
Lodging	29,548
Other Commercial	3,941
Restaurant	44,439
Small Office	1,540
Small Retail	6,111
Warehouse	1,239
Nursing	30,503
Multi-Family	15,434

γ_{Water} = Density of water
 = 8.33 pounds per gallon
 T_{out} = Tank temperature

⁹⁹⁴ Methodology based on Cadmus analysis. Annual hot water usage in gallons based on CBECS (2012) and RECS (2009) consumption data of East North Central (removed outliers of 1,000 kBtu/h or less) to calculate hot water usage. Annual hot water gallons per tank size gallons based on the tank sizing methodology found in ASHRAE 2011 HVAC Applications. Chapter 50 Service Water Heating. Demand assumptions (gallons per day) for each building type based on ASHRAE Chapter 50 and to LBNL White Paper. LBL-37398 Technology Data Characterizing Water Heating in Commercial Buildings: Application to End Use Forecasting. Assumes hot water heater efficiency of 80%.

⁹⁹⁵ According to CBECS 2012 “Lodging” buildings include Dormitories, Hotels, Motel or Inns and other Lodging and “Nursing” buildings include Assisted Living and Nursing Homes.

	= 125°F
T_{in}	= Incoming water temperature from well or municipal system = 50.7°F ⁹⁹⁶
1	= Heat Capacity of water (1 Btu/lb·°F)
3.412	= Conversion from Btu to kWh
$AFUE_{base}$	= Baseline Annual Fuel Utilization Efficiency Rating. For early replacement measures, use actual AFUE rating for the remaining useful life of the existing equipment (6 years for furnace, 8 years for boilers). For TOS, NC, and the remaining measure life of early replacement, use minimum standard efficiencies as specified in tables in ‘Definition of Baseline Equipment’ section.
FurnaceFlag	= 1 if system replaced is a gas furnace, 0 if not.
F_e	= Furnace Fan energy consumption as a percentage of annual fuel consumption = 7.7% ⁹⁹⁷
$EF_{GasBase}$	= Energy factor of Baseline natural gas DHW heater = Actual. If unknown or New Construction, assume federal standard as defined in applicable table in ‘Definition of Baseline Equipment’ section.
3412	= Btu per kWh
%IncentiveElectric	= % of total incentive paid by electric utility = Actual
%IncentiveGas	= % of total incentive paid by gas utility = Actual

⁹⁹⁶ Table 4 in Chen, et. al., “Calculating Average Hot Water Mixes of Residential Plumbing Fixtures”, June 2020, reports a value of 50.7°F for inlet water temperature for U.S. Census Division 3.

⁹⁹⁷ F_e is estimated using TRM models for the three most popular building types for programmable thermostats: low-rise office (10.2%), sit-down restaurant (8.6%), and retail – strip mall (4.4%). 7.7% reflects the average F_e of the three building types. See “Fan Energy Factor Example Calculation 2021-06-23.xlsx” for reference.

Non-Fuel Switch Illustrative Examples

New Construction using ASHP baseline:

For example, a 10 ton closed loop unit with Part Load EER rating of 20 and Part Load COP of 4.4, with desuperheater installed, and with a 100 gallon electric water heater in an new High School building in Chicago:

$$\begin{aligned} \Delta kWh &= [120,000 * 1,642 * (1/11 - 1/20) / 1000] + [1,549 * 120,000 * (1/11 - 1/(4.4*3.412)) / 1000] \\ &+ [1 * 0.44 * ((1/0.9568 * (100*672) * 8.33 * (125-50.7) * 1)/3412)] \\ &= 8,061 + 4,516 + 5,606 = 18,183 kWh \end{aligned}$$

Early Replacement:

For example, a 10 ton closed loop unit with Part Load EER rating of 20 and Part Load COP of 4.4 and with desuperheater installed in in an Assisted living building in Chicago with a 100 gallon electric water heater, replacing an existing working Air Source Heat Pump with efficiency ratings of 8.2 EER and 7.7 HSPF:

$$\begin{aligned} \Delta kWh \text{ for remaining life of existing unit (1st 8 years):} \\ &= [120,000 * 1,457 * (1/8.2 - 1/20) / 1000] + [1,646 * 120,000 * (1/7.7 - 1/(4.4*3.412)) / 1000] \\ &+ [1 * 0.44 * ((1/0.9568 * (100*672) * 8.33 * (125-50.7) * 1)/3412)] \\ &= 12,580 + 12,495 + 5606 = 30,681 kWh \end{aligned}$$

$$\begin{aligned} \Delta kWh \text{ for remaining measure life (next 17 years):} \\ &= [120,000 * 1,457 * (1/11 - 1/20) / 1000] + [1,646 * 120,000 * (1/11 - 1/(4.4*3.412)) / 1000] \\ &+ [1 * 0.44 * ((1/0.9568 * (100*672) * 8.33 * (125-50.7) * 1)/3412)] \\ &= 7,153 + 4,800 + 5,606 = 17,559 kWh \end{aligned}$$

Fuel Switch Illustrative Example

[for illustrative purposes a 50:50 Incentive is used for joint programs]

Early Replacement fuel switch:

A 10 ton closed loop unit with Part Load EER rating of 20 and Part Load COP of 4.4 in an Assisted Living building in Chicago with a 100 gallon gas water heater replaces an existing working natural gas boiler with 75% efficiency and central AC of 9.5 EER, and desuperheater installed with natural gas existing DHW heater:

$$\begin{aligned} \text{LifetimeSiteEnergySavings (MMBTUs)} &= \text{LifetimeGasHeatReplaced} + \text{LifetimeFurnaceFanSavings} - \\ &\text{LifetimeGSHPSiteHeatConsumed} + \text{LifetimeGSHPSiteCoolingImpact} + \\ &\text{LifetimeGSHPSiteWaterImpact} \end{aligned}$$

$$\begin{aligned} \text{LifetimeGasHeatReplaced} &= ((\text{HeatLoad} * 1/\text{AFUE}_{\text{exist}}) / 1,000,000 * 8 \text{ years}) + ((\text{HeatLoad} * \\ &1/\text{AFUE}_{\text{base}}) / 1,000,000 * 17 \text{ years}) \\ &= ((120,000 * 1,646 * 1/0.75) / 1,000,000 * 8) + ((120,000 * 1,646 * 1/0.8) / 1,000,000 * 17) \\ &= 6304.2 \text{ MMBtu} \end{aligned}$$

$$\begin{aligned} \text{LifetimeFurnaceFanSavings} &= ((\text{FurnaceFlag} * \text{HeatLoad} * 1/\text{AFUE}_{\text{exist}} * F_e) / 1,000,000 * 8 \text{ years}) \\ &+ ((\text{FurnaceFlag} * \text{HeatLoad} * 1/\text{AFUE}_{\text{base}} * F_{e_New}) / 1,000,000 * 17 \text{ years}) \\ &= 0 \text{ MMBtu} \end{aligned}$$

$$\begin{aligned} \text{LifetimeGSHPSiteHeatConsumed} &= (\text{HeatLoad} * 1/\text{COP}_{\text{GSHP}}) / 1,000,000 * 25 \text{ years} \\ &= (120,000 * 1,646 * 1/4.4) / 1,000,000 * 25 \\ &= 1122.3 \text{ MMBtu} \end{aligned}$$

Fuel Switch Illustrative Example continued

$$\text{LifetimeGSHPSiteCoolingImpact} = \left(\frac{((\text{EFLH}_{\text{cool}} * \text{Capacity}_{\text{cool}} * (1/\text{EER}_{\text{exist}} - 1/\text{EER}_{\text{GSHP}}))/1000 * 3412) / 1,000,000 * 6 \text{ years}}{1,000,000 * 19 \text{ years}} \right) + \left(\frac{((\text{EFLH}_{\text{cool}} * \text{Capacity}_{\text{cool}} * (1/\text{EER}_{\text{base}} - 1/\text{EER}_{\text{GSHP}}))/1000 * 3412) / 1,000,000 * 19 \text{ years}}{1,000,000 * 19 \text{ years}} \right)$$

$$= \left(\frac{((120000 * 1,457 * (1/9.5 - 1/20)) / 1000 * 3412) / 1,000,000 * 6}{1,000,000 * 19} \right) + \left(\frac{((120000 * 1,457 * (1/11 - 1/20)) / 1000 * 3412) / 1,000,000 * 19}{1,000,000 * 19} \right)$$

$$= 661.5 \text{ MMBtu}$$

$$\text{LifetimeGSHPSiteWaterImpact}_{\text{Gas}} = \left(\frac{(\% \text{DHWDisplaced} * ((1/\text{EF}_{\text{Gas}} * \text{GPD} * \text{Household} * 365.25 * \gamma_{\text{Water}} * (T_{\text{OUT}} - T_{\text{IN}}) * 1.0) / 1,000,000) * 25 \text{ years}}{1,000,000} \right)$$

$$= (0.44 * (1/0.8 * (100*672) * 8.33 * (125-50.7) * 1) / 1,000,000) * 25$$

$$= 571.9 \text{ MMBtu}$$

$$\text{LifetimeSiteEnergySavings (MMBTUs)} = 6304.2 + 0 - 1122.3 + 661.5 + 571.9 = 6,415 \text{ MMBtu [Measure is eligible]}$$

First 6 years:

$$\text{SiteEnergySavings_FirstYear (MMBTUs)} = \text{GasHeatReplaced} + \text{FurnaceFanSavings} - \text{GSHPSiteHeatConsumed} + \text{GSHPSiteCoolingImpact} + \text{GSHPSiteWaterImpact}$$

$$\text{GasHeatReplaced} = (\text{HeatLoad} * 1/\text{AFUE}_{\text{exist}}) / 1,000,000$$

$$= (120,000 * 1,646 * 1/0.75) / 1,000,000$$

$$= 263.4 \text{ MMBtu}$$

$$\text{FurnaceFanSavings} = (\text{FurnaceFlag} * \text{HeatLoad} * 1/\text{AFUE}_{\text{exist}} * F_e) / 1,000,000$$

$$= 0 \text{ MMBtu}$$

$$\text{GSHPSiteHeatConsumed} = (\text{HeatLoad} * 1/\text{COP}_{\text{GSHP}}) / 1,000,000$$

$$= (120,000 * 1,646 * 1/4.4) / 1,000,000$$

$$= 44.9 \text{ MMBtu}$$

$$\text{GSHPSiteCoolingImpact} = \left(\frac{((\text{EFLH}_{\text{cool}} * \text{Capacity}_{\text{cool}} * (1/\text{EER}_{\text{exist}} - 1/\text{EER}_{\text{GSHP}}))/1000 * 3412) / 1,000,000}{1,000,000} \right)$$

$$= \left(\frac{((120000 * 1,457 * (1/9.5 - 1/20)) / 1000 * 3412) / 1,000,000}{1,000,000} \right)$$

$$= 33.0 \text{ MMBtu}$$

$$\text{GSHPSiteWaterImpact}_{\text{Gas}} = \left(\frac{(\% \text{DHWDisplaced} * ((1/\text{EF}_{\text{Gas}} * \text{GPD} * \text{Household} * 365.25 * \gamma_{\text{Water}} * (T_{\text{OUT}} - T_{\text{IN}}) * 1.0) / 1,000,000)}{1,000,000} \right)$$

$$= (0.44 * (1/0.8 * (100*672) * 8.33 * (125-50.7) * 1) / 1,000,000)$$

$$= 22.9 \text{ MMBtu}$$

$$\text{SiteEnergySavings_FirstYear (MMBTUs)} = 263.4 + 0 - 44.9 + 33 + 22.9 = 274.4 \text{ MMBtu}$$

Fuel Switch Illustrative Example continued

Remaining 10 years:

$$\text{SourceEnergySavings_PostAdj (MMBTUs)} = \text{GasHeatReplaced} + \text{FurnaceFanSavings} - \text{GSHPSourceHeatConsumed} + \text{GSHPSourceCoolingImpact} + \text{GSHPSourceWaterImpact}$$

$$\begin{aligned} \text{GasHeatReplaced} &= (\text{HeatLoad} * 1/\text{AFUE}_{\text{exist}}) / 1,000,000 \\ &= (120,000 * 1,646 * 1/0.8) / 1,000,000 \\ &= 246.9 \text{ MMBtu} \end{aligned}$$

$$\begin{aligned} \text{FurnaceFanSavings} &= (\text{FurnaceFlag} * \text{HeatLoad} * 1/\text{AFUE}_{\text{exist}} * F_e) / 1,000,000 \\ &= 0 \text{ MMBtu} \end{aligned}$$

$$\begin{aligned} \text{GSHPSiteHeatConsumed} &= (\text{HeatLoad} * 1/\text{COP}_{\text{GSHP}}) / 1,000,000 \\ &= (120,000 * 1,646 * 1/4.4) / 1,000,000 \\ &= 44.9 \text{ MMBtu} \end{aligned}$$

$$\begin{aligned} \text{GSHPSiteCoolingImpact} &= ((\text{EFLH}_{\text{cool}} * \text{Capacity}_{\text{Cool}} * (1/\text{EER}_{\text{exist}} - 1/\text{EER}_{\text{GSHP}})) / 1000 * 3412) / 1,000,000 \\ &= ((120000 * 1,457 * (1/11 - 1/20)) / 1000 * 3412) / 1,000,000 \\ &= 24.4 \text{ MMBtu} \end{aligned}$$

$$\begin{aligned} \text{GSHPSiteWaterImpact}_{\text{Gas}} &= (\% \text{DHWD}_{\text{Displaced}} * ((1/\text{EF}_{\text{Gas}} * \text{GPD} * \text{Household} * 365.25 * \gamma_{\text{Water}} * (T_{\text{OUT}} - T_{\text{IN}}) * 1.0) / 1,000,000 \\ &= (0.44 * (1/0.8 * (100 * 672) * 8.33 * (125 - 50.7) * 1) / 1,000,000 \\ &= 22.9 \text{ MMBtu} \end{aligned}$$

$$\text{SourceEnergySavings_PostAdj (MMBTUs)} = 246.9 + 0 - 44.9 + 24.4 + 22.9 = 249.3 \text{ MMBtu}$$

Savings would be claimed as follows:

Measure supported by:	Electric Utility claims:	Gas Utility claims:
Electric utility only	First 6 years: $274.4 * 1,000,000 / 3412$ = 80,422 kWh Remaining 10 years: $249.3 * 1,000,000 / 3412$ = 73,066 kWh	N/A
Electric and gas utility	First 6 years: $0.5 * 274.4 * 1,000,000 / 3412$ = 40,211 kWh Remaining 10 years: $0.5 * 249.3 * 1,000,000 / 3412$ = 36,533 kWh	First 6 years: $0.5 * 274.4 * 10$ = 1372 Therms Remaining 10 years: $0.5 * 249.3 * 10$ = 1247 Therms
Gas utility only	N/A	First 6 years: $274.4 * 10$ = 2744 Therms Remaining 10 years: $249.3 * 10$ = 2493 Therms

$$\Delta kW = (\text{Capacity}_{\text{Cool}} * (1/\text{EER}_{2\text{base}} - 1/\text{EER}_{2\text{GSHP}}))/1000 * \text{CF}$$

Where:

CF_{SSP} = Summer System Peak Coincidence Factor for Central A/C (during system peak hour)
= 91.3%⁹⁹⁸

CF_{PJM} = PJM Summer Peak Coincidence Factor for Central A/C (average during peak period)
= 47.8%⁹⁹⁹

New Construction or Time of Sale:

For example, a 10 ton closed loop unit with Full Load EER rating of 20:

$$\begin{aligned} \Delta kW_{\text{SSP}} &= (120,000 * (1/11 - 1/20))/1000 * 0.913 \\ &= 4.482\text{kW} \end{aligned}$$

$$\begin{aligned} \Delta kW_{\text{PJM}} &= (36,000 * (1/11 - 1/20))/1000 * 0.478 \\ &= 2.347\text{kW} \end{aligned}$$

Early Replacement:

For example, a 10 ton closed loop unit with Full Load 20 EER replaces an existing working Air Source Heat Pump with 8.2 EER:

$$\begin{aligned} \Delta kW_{\text{SSP}} \text{ for remaining life of existing unit (1st 8 years):} \\ &= (120,000 * (1/8.2 - 1/20))/1000 * 0.913 \\ &= 7.883 \text{ kW} \end{aligned}$$

$$\begin{aligned} \Delta kW_{\text{SSP}} \text{ for remaining measure life (next 17 years):} \\ &= (120,000 * (1/11 - 1/20))/1000 * 0.913 \\ &= 4.482\text{kW} \end{aligned}$$

$$\begin{aligned} \Delta kW_{\text{PJM}} \text{ for remaining life of existing unit (1st 8 years):} \\ &= (120,000 * (1/8.2 - 1/20))/1000 * 0.478 \\ &= 4.127 \text{ kW} \end{aligned}$$

$$\begin{aligned} \Delta kW_{\text{PJM}} \text{ for remaining measure life (next 17 years):} \\ &= (120,000 * (1/11 - 1/20))/1000 * 0.478 \\ &= 2.347\text{kW} \end{aligned}$$

FOSSIL FUEL SAVINGS

Calculation provided together with Electric Energy Savings above.

⁹⁹⁸ Based on analysis of Itron eShape data for Missouri, calibrated to Illinois loads, supplied by Ameren. The AC load during the utility’s peak hour is divided by the maximum AC load during the year.

⁹⁹⁹ Based on analysis of Itron eShape data for Missouri, calibrated to Illinois loads, supplied by Ameren. The average AC load over the PJM peak period (1-5pm, M-F, June through August) is divided by the maximum AC load during the year.

WATER AND OTHER NON-ENERGY IMPACT DESCRIPTIONS AND CALCULATION

N/A

DEEMED O&M COST ADJUSTMENT CALCULATION

N/A

COST EFFECTIVENESS SCREENING AND LOAD REDUCTION FORECASTING WHEN FUEL SWITCHING

This measure can involve fuel switching from gas to electric.

For the purposes of forecasting load reductions due to fuel switch GSHP projects; changes in site energy use at the customer’s meter (using ΔkWh algorithm below), customer switching estimates, NTG, and any other adjustment factors deemed appropriate, should be used.

The inputs to cost effectiveness screening should reflect the actual impacts on the electric and fuel consumption at the customer meter and, for fuel switching measures, should therefore reflect the decrease in one fuel and increase in another, as opposed to the single savings value calculated in the “Electric and Fossil Fuel Energy Savings” section above. Therefore in addition to the calculation of savings claimed, the following values should be used to assess the cost effectiveness of the measure. For Early Replacement measures, the efficiency terms of the existing unit should be used for the remaining useful life of the existing equipment (6 years for ASHP and Central AC, 7 years for furnace, 8 years for boilers or GSHP, 15 years for electric resistance), and the efficiency terms for a new baseline unit should be used for the remaining years of the measure.

$$\begin{aligned} \Delta \text{Therms} &= [\text{Heating Consumption Replaced}] + [\text{DHW Savings if existing natural gas DHW}] \\ &= [(\text{HeatLoad} * 1 \text{ AFUE}_{\text{base}}) / 100,000] + [(1 - \text{ElecDHW}) * \% \text{DHW} * (1 / \text{EF}_{\text{GasBase}} * \\ &\quad \text{HotWaterUse}_{\text{Gallon}} * \gamma_{\text{Water}} * (T_{\text{OUT}} - T_{\text{IN}}) * 1.0) / 100,000] \\ \\ \Delta kWh &= [\text{FurnaceFanSavings}] - [\text{GSHP heating consumption}] + [\text{Cooling savings}] + [\text{DHW savings} \\ &\quad \text{if existing electric DHW}] \\ &= [\text{FurnaceFlag} * \text{HeatLoad} * 1 / \text{AFUE}_{\text{base}} * F_e * 0.000293] - [(\text{HeatLoad} * (1 / \text{COP}_{\text{GSHP}} * \\ &\quad 3.412)) / 1000] + [(\text{EFLH}_{\text{cool}} * \text{Capacity}_{\text{Cool}} * (1 / \text{EER}_{2\text{base}} - 1 / \text{EER}_{2\text{GSHP}})) / 1000] + [\text{ElecDHW} * \\ &\quad \% \text{DHW} * ((1 / \text{EF}_{\text{ELEC}} * \text{HotWaterUse}_{\text{Gallon}} * \gamma_{\text{Water}} * (T_{\text{OUT}} - T_{\text{IN}}) * 1.0) / 3412)] \end{aligned}$$

Illustrative Example of Cost Effectiveness Inputs for Fuel Switching:

For example, a 10 ton unit with Part Load EER rating of 20 and Part Load COP of 4.4 in an Assisted living building in Chicago with a 100 gallon gas water heater replaces an existing working natural gas boiler with 75% efficiency and air-cooled chiller of 9.5 EER. [Note the calculation provides the annual savings for the first 8 years of the measure life, an additional calculation (not shown) would be required to calculate the annual savings for the remaining life (years 9-25)]:

$$\begin{aligned} \Delta\text{Therms} &= [\text{HeatLoad} * 1 \text{ AFUE}_{\text{base}}] / 100,000 + [(1 - \text{ElecDHW}) * \% \text{DHW} * (1 / \text{EF}_{\text{GasBase}} * \\ &\quad \text{HotWaterUse}_{\text{Gallon}} * \gamma_{\text{Water}} * (T_{\text{OUT}} - T_{\text{IN}}) * 1.0) / 100,000] \\ &= [(120,000 * 1,646 * 1/0.75)/100,000] + [(1 - 0) * 0.44 * (1/0.8 * (100*672) * 8.33 * (125- \\ &\quad 50.7) * 1) / 100,000] \\ &= 2,634 + 229 \\ &= 2,863 \text{ therms} \\ \Delta\text{kWh} &= [\text{FurnaceFlag} * \text{HeatLoad} * 1/\text{AFUE}_{\text{base}} * F_e * 0.000293] - [(\text{HeatLoad} * (1/ \text{COP}_{\text{GSHP}} * \\ &\quad 3.412))/1000] + [(\text{EFLH}_{\text{cool}} * \text{Capacity}_{\text{Cool}} * (1/\text{EER}_{\text{base}} - 1/\text{EER}_{\text{GSHP}}))/1000] + [\text{ElecDHW} * \% \text{DHW} \\ &\quad * ((1/\text{EF}_{\text{ELEC}} * \text{HotWaterUse}_{\text{Gallon}} * \gamma_{\text{Water}} * (T_{\text{OUT}} - T_{\text{IN}}) * 1.0) / 3412)] \\ &= 0 - [(1646 * 120,000 * (1/ 4.4 * 3.412))/1000] + [(1457* 120000 * (1/11 - 1/20))/1000] + [0 \\ &\quad * (0.44 * ((1/0.9568) * (100*672) * 8.33 * (125 - 50.7) * 1 / 3412))] \\ &= 0 - 153,168 + 7153 + 0 \\ &= -146,015 \text{ kWh} \end{aligned}$$

MEASURE CODE: CI-HVC-GSHP-V09-250101

REVIEW DEADLINE: 1/1/2028

4.4.45 Adsorbent Air Cleaning

DESCRIPTION

The Adsorbent Air Cleaning (AAC) measure installs modular adsorbent air cleaning devices (“AAC modules”) into commercial forced air HVAC systems. These devices pass return air through adsorbent media which remove the gas-phase contaminants carbon dioxide and species of volatile organic compounds (VOCs) from the return air, allowing it to be recirculated rather than removed from the building as exhaust and replaced with ventilation air. This allows HVAC system operators to substantially reduce the amount of outside air brought in for ventilation while still maintaining acceptable indoor air quality, resulting in heating and cooling energy savings. An energy penalty is incurred due to the operation of fans integrated within the AAC modules, as well as from integrated electric heaters used in a regeneration cycle which purges the adsorbent media of contaminants to allow them to be used again. Net energy savings are calculated and are equal to the cooling and heating energy savings due to reduced outdoor air minus the energy required to operate the AAC modules.

This measure serves the market for medium to large commercial and institutional buildings.

This measure is currently applicable to the following program types: NC, RF, DI. If applied to other program types, the measure savings should be verified.

DEFINITION OF EFFICIENT EQUIPMENT

Efficient equipment is defined as a commercial HVAC system which has AAC modules installed in the return airstream, with the number of modules determined by appropriate sizing calculations. The modules allow for a substantial reduction in the volume of outside air introduced to the building compared to systems without AAC modules.

DEFINITION OF BASELINE EQUIPMENT

Baseline equipment is a variable air volume HVAC system equipped with an integrated economizer and which does not have AAC modules installed. Heating is provided by either electricity, natural gas, or heat pump.

DEEMED LIFETIME OF EFFICIENT EQUIPMENT

The expected measure life for HVAC applications is 20 years.¹⁰⁰⁰

DEEMED MEASURE COST

Actual measure costs should be used if available. If costs are not available, the deemed measure cost below can be used, which is based on a cost per cfm of supply air flow rate.¹⁰⁰¹

Unit	Material Cost / Unit (\$/cfm)	Labor Cost / Unit (\$/cfm)	Total Cost / Unit (\$/cfm)
Supply Air CFM	\$0.90	\$0.48	\$1.38

For example, the default deemed measure cost of installing the AAC measure in an HVAC system with a design supply air flow rate of 75,000 cfm is:

$$\text{Deemed Measure Cost (\$)} = 75,000 \text{ cfm} * \$1.38/\text{cfm} = \$103,500$$

LOADSHAPE

For buildings with gas heat:

Loadshape C03 – Commercial Cooling

¹⁰⁰⁰ Expected lifetime based on median years of axial fans and dampers from the ASHRAE Equipment Life Expectancy Chart.

¹⁰⁰¹ Default measure cost is based on sales information and labor cost estimates provided by a major Original Equipment Manufacturer (OEM) of AAC units. The OEM's estimates are based on prior installation experiences and case studies.

For buildings with electric heat:

Loadshape C05 – Commercial Electric Heating and Cooling

COINCIDENCE FACTOR

The coincidence factor is assumed to be the PJM Summer Peak Coincidence Factor for Commercial Cooling:

$$CF_{PJM} = 47.8\%^{1002}$$

Algorithm

CALCULATION OF ENERGY SAVINGS

Savings associated with the Adsorbent Air Cleaning measure were derived from the results of a pilot study conducted in a commercial office building in Chicago during the 2019-2020 cooling and heating seasons. The building had a VAV system with economizer and electric heat. During the study, outdoor air rates were reduced according to the AAC module manufacturer’s recommendations. Building cooling and heating loads associated with preconditioning outdoor air were continuously measured both with baseline and reduced outdoor air flow rates over a range of outdoor air temperatures and humidities. Statistical models were developed to predict energy and peak electric load savings as a function of outdoor air flow rate and outdoor air conditions. The models were then used to simulate energy use and peak load savings in other Illinois climate zones using TMY data.

In addition to monitoring cooling and heating energy, the pilot study also measured the electricity used to operate the AAC modules for the duration of the cooling and heating seasons. This energy penalty was subtracted from the cooling and heating load savings to calculate net savings.

ELECTRIC ENERGY SAVINGS

Identify the building’s heating fuel. Electric energy savings will differ for buildings with natural gas, electric resistance, or electric heat pumps as a heating fuel.

For buildings with **natural gas** as a heating fuel, electric energy savings are:

$$\Delta kWh = \Delta V_{OA} * (NCLS / Cooling_{COP} - Annual Electric_{AAC})$$

For buildings with **electric resistance** as a heating fuel, electric energy savings are:

$$\Delta kWh = \Delta V_{OA} * (NCLS / Cooling_{COP} + NHLS - Annual Electric_{AAC})$$

For buildings with **electric heat pumps** as a heating fuel, electric energy savings are:

$$\Delta kWh = \Delta V_{OA} * (NCLS / Cooling_{COP} + NHLS / Heating_{COP} - Annual Electric_{AAC})$$

Where:

ΔV_{OA} = reduction in minimum outside air flow in scfm due to incorporating an AAC module

= if the rate is unknown, calculate using the following equation:

$$\Delta V_{OA} = V_{supply} * F_{OA} * F_R, \text{ where:}$$

V_{supply} = design or operational peak supply air flow rate of air handler in scfm

¹⁰⁰² Based on analysis of Itron eShape data for Missouri, calibrated to Illinois loads, supplied by Ameren. The average AC load over the PJM peak period (1-5pm, M-F, June through August) is divided by the maximum AC load during the year.

F_{OA} = operational minimum fraction of outside air in supply airflow before installing AAC modules

F_R = percentage reduction of outside air due to AAC modules
 = custom; if unknown, use 0.7 as a default¹⁰⁰³

NCLS (Normalized Cooling Load Savings)

= $\Delta kWh/\Delta scfm$ savings value for the appropriate climate zone in the table below:

Normalized Cooling Load Savings (kWh/cfm)				
Rockford – Zone 1	Chicago – Zone 2	Springfield – Zone 3	Mt. Vernon/Belleville – Zone 4	Marion – Zone 5
17.9	18.6	24.2	26.5	23.6

NHLS (Normalized Heating Load Savings)

= $\Delta kWh/\Delta scfm$ savings value for the appropriate climate zone and F_{OA} in the table below:

F_{OA}	Normalized Heating Load Savings (kWh/cfm)				
	Rockford – Zone 1	Chicago – Zone 2	Springfield – Zone 3	Mt. Vernon/Belleville – Zone 4	Marion – Zone 5
0.10	2.24	1.13	1.09	0.76	0.95
0.15	3.32	1.94	2.14	1.72	1.81
0.20	3.90	2.44	2.76	2.28	2.37
0.25	4.31	2.80	3.09	2.53	2.68
0.30	4.54	3.05	3.25	2.68	2.85

$Cooling_{COP}$ = seasonal average COP of building cooling plant. If unknown, use 4.0 as a default¹⁰⁰⁴

$Heating_{COP}$ = seasonal average COP of heat pump. If unknown, use 2.5 as a default¹⁰⁰⁵

Annual $Electric_{AAC}$ = annual electricity consumed by AAC modules for the appropriate climate zone

AAC Electricity Consumption (kWh/cfm)				
Rockford – Zone 1	Chicago – Zone 2	Springfield – Zone 3	Mt. Vernon/Belleville – Zone 4	Marion – Zone 5
1.07	0.91	1.06	0.98	0.89

¹⁰⁰³ The default value of 0.7 for F_R is based on a survey of previous case studies which documented the field installation of AAC modules in existing HVAC systems.

¹⁰⁰⁴ The default cooling COP value of 4.0 is an approximation consistent with cooling analysis in the LEED rating system, and approximates a modern, moderate efficiency water-cooled chiller (COP = 6.0) with cooling tower and pump energy usage.

¹⁰⁰⁵ The default heating COP value of 2.5 is an approximation representing an air-source heat pump of moderate efficiency.

For example, office building in Climate Zone 3 is equipped with a VAV system with electric heat and has a cooling plant COP of 4.0, a design supply air flow rate of 50,000 scfm and an outdoor air ventilation rate of 10,000 scfm. Installing AAC modules will allow reduction of the outdoor air ventilation rate by 70%. In this case:

$$V_{\text{supply}} = 50,000 \text{ scfm}$$

$$F_{\text{OA}} = 10,000 \text{ scfm} / 50,000 \text{ scfm} = 0.2$$

$$F_{\text{R}} = 0.7$$

$$\Delta V_{\text{OA}} = V_{\text{supply}} * F_{\text{OA}} * F_{\text{R}} = 50,000 \text{ scfm} * 0.2 * 0.7 = 7,000 \text{ scfm}$$

$$\text{Normalized Cooling Load Savings} = 24.2 \text{ kWh/scfm (Climate zone 3, } F_{\text{OA}} = 0.2)$$

$$\text{Cooling}_{\text{COP}} = 4.0$$

$$\text{Normalized Heating Load Savings} = 2.76 \text{ kWh/scfm (Climate zone 3, } F_{\text{OA}} = 0.2)$$

$$\text{Annual Electric}_{\text{AAC}} = 1.06 \text{ kWh/scfm (Climate zone 3)}$$

$$\begin{aligned} \Delta \text{kWh} &= \Delta V_{\text{OA}} * (\text{NCLS} / \text{Cooling}_{\text{COP}} + \text{NHLS} - \text{Annual Electric}_{\text{AAC}}) \\ &= 7,000 \text{ scfm} * (24.2 \text{ kWh/scfm} / 4.0 + 2.76 \text{ kWh/scfm} - 1.06 \text{ kWh/scfm}) \\ &= 54,250 \text{ kWh} \end{aligned}$$

SUMMER COINCIDENT PEAK DEMAND SAVINGS

$$\Delta \text{kW} = \Delta V_{\text{OA}} * (\text{Normalized Peak Cooling Load Savings} / \text{Cooling}_{\text{COP}}) * \text{CF}_{\text{PJM}}$$

Where:

$$\text{CF}_{\text{PJM}} = 0.478$$

Normalized Peak Cooling Load Savings

= $\Delta \text{kW} / \Delta \text{scfm}$ savings value for the appropriate combination of building type, climate zone, and measure scenario, as detailed in the table below

Normalized Peak Cooling Load Savings (kW/cfm)				
Rockford – Zone 1	Chicago – Zone 2	Springfield – Zone 3	Mt. Vernon/Belleville – Zone 4	Marion – Zone 5
0.0259	0.0256	0.0296	0.0293	0.0283

FOSSIL FUEL SAVINGS

Natural gas savings do not apply to buildings where electricity is the heating fuel. For buildings where natural gas is the heating fuel:

$$\Delta \text{therms} = \Delta V_{\text{OA}} * (\text{NHLS} / \eta) * 0.03412$$

Where:

$$\eta = \text{efficiency of gas heating equipment. If unknown, use 0.78 as default.}$$

$$0.03412 = \text{therms per kWh. Conversion factor to convert kWh to therms}$$

MEASURE CODE: CI-HVC-ADAC-V04-240101

REVIEW DEADLINE: 1/1/2027

4.4.46 Server Room Temperature Set back

DESCRIPTION

This measure involves adjusting existing thermostats or building automation systems for reduced cooling energy consumption and fan energy consumption in server room and/or data center spaces. Existing set points should be documented through an audit or retro-commissioning study. A maximum temperature adjustment of 95°F will limit significant increase in server fan power consumption.

This measure was developed to be applicable to the following program types: RF, DI

If applied to other program types, the measure savings should be verified.

DEFINITION OF EFFICIENT EQUIPMENT

The criteria for this measure is established by optimizing the cooling temperature setpoint with a commercial thermostat or building automation system, up to a maximum of 95°F, which is adjusted to meet or approach ASHRAE recommended standards for data center cooling.

DEFINITION OF BASELINE EQUIPMENT

The baseline for this measure is a commercial thermostat or building automation system that is currently controlling to cooling temperature setpoints that do not align with ASHRAE TC 9.9.

DEEMED LIFETIME OF EFFICIENT EQUIPMENT

The expected measure life of a programmable thermostat is assumed to be 8 years.¹⁰⁰⁶ For the purposes of claiming savings for an adjustment of an existing thermostat, this is reduced to a 50% persistence factor to give a final measure life of 4 years. It is recommended that this assumption be evaluated by future energy measurement and verification activities.

DEEMED MEASURE COST

Actual labor costs should be used if the implementation method allows. If unknown the labor cost for this measure is assumed to be \$35.24 per thermostat,¹⁰⁰⁷ as summarized in the following table.

Measure	Units	Materials	Labor	Total Cost (including O&P)	City Cost Index (Install Only)*	Total	Source
Adjust Temperature Set Points	4	\$0.00	\$5.95	\$6.55	134.5%	\$35.24	RS Means 2010 (pg 255, Section 23-09-8100)
* Chicago, IL – Division 23							

LOADSHAPE

Loadshape C03 – Commercial Cooling

COINCIDENCE FACTOR

Since the server room is cooled 8760 hours, the summer peak coincidence factor is assumed to be 100%.

¹⁰⁰⁶ 8 years is based upon ASHRAE Applications (2003), Section 36, Table 3 estimate of 16 years for the equipment life, reduced by 50% to account for persistence issues.

¹⁰⁰⁷ RSMMeans, "Instrumentation and Control for HVAC", Mechanical Cost Data, Kingston, MA: Reed Construction Data, 2010, pg. 255 & 632.

Algorithm

CALCULATION OF ENERGY SAVINGS

ELECTRIC ENERGY SAVINGS

$$\Delta kWh = \text{Capacity} * (1/\text{EER}) * \text{EFLH} * \text{LF} * \% \text{Savings} * (T_{\text{after}} - T_{\text{before}})$$

Where:

- Capacity = Capacity of the cooling equipment actually installed in kBtu per hour (1 ton of cooling capacity equals 12 kBtu/hr)
= Actual
- EER = Energy efficiency ratio of the equipment
= Actual
- EFLH = Equivalent full load hours for cooling
= 8,760
- LF = Load Factor,
= 65%¹⁰⁰⁸
- %Savings = Deemed percent savings
= 4% per degree increase¹⁰⁰⁹
- T_{after} = Space temperature setpoint after adjustment, maximum of 95°F
= Actual
- T_{before} = Space temperature setpoint before adjustment
= Actual

SUMMER COINCIDENT PEAK DEMAND SAVINGS

$$\Delta kW = \text{Capacity} * (1/\text{EER}) * \text{LF} * \% \text{Savings} * (T_{\text{after}} - T_{\text{before}}) * \text{CF}$$

Where:

- CF = Summer Peak Coincidence Factor for measure
= 1.0

FOSSIL FUEL SAVINGS

N/A

WATER AND OTHER NON-ENERGY IMPACT DESCRIPTIONS AND CALCULATION

N/A

DEEMED O&M COST ADJUSTMENT CALCULATION

N/A

¹⁰⁰⁸ASHRAE Technical Support Document, 4.2.3.2 “Estimate the Average Computer Server Heat Load”, page 4-15.

¹⁰⁰⁹J. Brandon. “Going Green In The Data Center: Practical Steps For Your SME To Become More Environmentally Friendly. Processor”, 29, Sept. 2007.

MEASURE CODE: CI-HVC-SRSB-V01-200101

REVIEW DEADLINE: 1/1/2024

4.4.47 Air Deflectors for Unit Ventilators – Provisional Measure – Removed V12.

4.4.48 Small Commercial Thermostats

DESCRIPTION

This measure characterizes the energy savings from the installation of either a Programmable or an advanced Thermostat to reduce heating and cooling consumption in a small commercial building.

The thermostat must be installed to control a single-zone HVAC system. This measure is limited to packaged HVAC units 10 tons or less. This measure should not be used when HVAC systems are being replaced, in new construction and whenever code compliance is required.

The savings associated with small commercial installations of thermostats had not been well evaluated at the time this measure was created for TRM Version 8.0. In the absence of assumptions specific to small commercial customers, the percent savings derived from Illinois Residential evaluations were used. In version 9.0 the cooling savings percentage was updated based on research conducted on small commercial programmable thermostat applications.¹⁰¹⁰ In CY2020, additional research was performed to support a potential update to the heating savings percentage. The results did not provide a sufficient statistically significant basis for changing the current assumption.

Note that while these devices and service could potentially be used as part of a demand response program, the costs, delivery, impacts, and other aspects of DR-specific program delivery are not included in this characterization at this time, though they could be added in the future.

This measure was developed to be applicable to the following program types: TOS, RF, DI.

If applied to other program types, the measure savings should be verified.

DEFINITION OF EFFICIENT EQUIPMENT

The criteria for this measure are established by replacement of a manual-only thermostat, with one that has the capability to establish a schedule of time and/or temperature setpoints, or replacement of a programmable thermostat with an Advanced Thermostat.

DEFINITION OF BASELINE EQUIPMENT

The baseline is assumed to be a manual or programmable thermostat.

DEEMED LIFETIME OF EFFICIENT EQUIPMENT

The expected measure life is assumed to be 11 years.¹⁰¹¹

DEEMED MEASURE COST

For DI and other programs for which installation services are provided, the actual material, labor, and other costs should be used. If unknown then the average incremental cost for the new installation measure is assumed to be \$175.

LOADSHAPE

Loadshape C05 – Commercial Electric Heating and Cooling, or

Loadshape C03 – Commercial Cooling

COINCIDENCE FACTOR

In the absence of conclusive results from empirical studies on peak savings, the TAC agreed to a temporary assumption of 50% of the cooling coincidence factor, acknowledging that while the savings from the Thermostat will

¹⁰¹⁰ See "Small Commercial Thermostats Research," memorandum from Guidehouse to ComEd dated May 15, 2020.

¹⁰¹¹ Based on 2017 Residential Smart Thermostat Workpaper, prepared by SCE and Nest for SCE (Work Paper SCE17HC054, Revision #0). Estimate ability of smart systems to continue providing savings after disconnection and conduct statistical survival analysis which yields 9.2-13.8 year range.

track with the cooling load, the impact during peak periods may be lower. This is an assumption that could use future evaluation to improve these estimates.

$$\begin{aligned} CF_{SSP} &= \text{Summer System Peak Coincidence Factor for Commercial cooling (during system peak hour)} \\ &= 45.7^{1012} \end{aligned}$$

$$\begin{aligned} CF_{PJM} &= \text{PJM Summer Peak Coincidence Factor for Commercial cooling (average during peak period)} \\ &= 23.9\%^{1013} \end{aligned}$$

Algorithm

CALCULATION OF ENERGY SAVINGS

ELECTRIC ENERGY SAVINGS

Heating savings are provided based upon the percentage savings from the Residential version of this measure. Cooling savings are based on research on small commercial programmable thermostat installations. Future research on heating savings percentages for small commercial applications, and heating and cooling savings percentages for Advanced Thermostat applications, should be used to improve this assumption.

$$\begin{aligned} \Delta kWh^{1014} &= \Delta kWh_{\text{heating}} + \Delta kWh_{\text{cooling}} \\ \Delta kWh_{\text{heating}} &= (\%ElecHeat * kBtu/hr_{\text{heat}} * 1/HSPF2 * EFLH_{\text{heat}} * Heating_Reduction * BAF) + \\ &\quad (\Delta Therms * F_e * 29.3) \\ \Delta kWh_{\text{cool}} &= kBtu/hr_{\text{cool}} * 1/SEER2 * EFLH_{\text{cool}} * Cooling_Reduction * BAF \end{aligned}$$

Where:

- %ElecHeat** = Percentage of heating savings assumed to be electric
= 1 if electric heat, 0 if gas heat. If unknown assume 0.08¹⁰¹⁵.
- kBtu/hr_{heat}** = capacity of the heating equipment in kBtu per hour.
= Actual. If unknown assume 114.5¹⁰¹⁶
- HSPF2** = Heating Seasonal Performance Factor of the equipment
= Actual, if unknown a blended baseline value of 5.1 HSPF2¹⁰¹⁷.
- EFLH_{heat}** = Heating mode equivalent full load hours in Existing Buildings are provided in section 4.4 HVAC End Use.
- Heating_Reduction** = Assumed percentage reduction in total building heating energy consumption due to thermostat

¹⁰¹² Based on analysis of Itron eShape data for Missouri, calibrated to Illinois loads, supplied by Ameren. The AC load during the utility’s peak hour is divided by the maximum AC load during the year. Multiplied by 50%.

¹⁰¹³ Based on analysis of Itron eShape data for Missouri, calibrated to Illinois loads, supplied by Ameren. The average AC load over the PJM peak period (1-5pm, M-F, June through August) is divided by the maximum AC load during the year. Multiplied by 50%.

¹⁰¹⁴ Electrical savings are a function of both heating and cooling energy usage reductions. For heating this is a function of the percent of electric heat (heat pumps) and fan savings in the case of a natural gas furnace.

¹⁰¹⁵ Based on percentage of customers in ComEd Small Business Thermostat program with electric heat.

¹⁰¹⁶ Average capacity of 705 installs of thermostats in Ameren Illinois territory installed from 2015-2020.

¹⁰¹⁷ Blended Baseline value came from percentage of accounts with heat pumps (40.17%) at 7.5 HSPF2 and electric furnaces (59.83%) at 3.41 HSPF as reported in the ComEd Baseline Study August 14, 2020.

	= 8.8% ¹⁰¹⁸
ΔTherms	= Therm savings if Natural Gas heating system = See calculation in Fossil Fuel section below
F _e	= Furnace Fan energy consumption as a percentage of annual fuel consumption = 7.7% ¹⁰¹⁹
29.3	= kWh per therm
kBtu/hr _{cool}	= capacity of the cooling equipment actually installed in kBtu per hour (1 ton of cooling capacity equals 12 kBtu/hr) = Actual. If unknown assume 61.0 ¹⁰²⁰
SEER2	= Seasonal Energy Efficiency Ratio of the cooling equipment = Actual, is unknown assume Code base. For midstream programs, assume a value of 12.4 SEER2. ¹⁰²¹
EFLH _{cool}	= Equivalent Full Load Hours for cooling in Existing Buildings are provided in section 4.4 HVAC End Use.
Cooling_Reduction	= Average percentage reduction in total building cooling energy consumption due to installation of thermostat: = 17.7% ¹⁰²²
BAF	= Baseline adjustment factor.

¹⁰¹⁸ Assumed equal to assumption for Residential Advanced Thermostats with manual thermostat baseline, before adding savings from Thermostat Optimization (which is not applicable to small commercial customers). Note that a Guidehouse billing study in CY2020 did not find a statistically significant basis for adjusting this assumption for commercial applications, see "Small Commercial Thermostats TRM Research" memo. April 21, 2021.

Estimates of heating and cooling reduction factors are based on consumption data analyses with matching to non-participants and are therefore net with respect to participant spillover and between net and gross with respect to free ridership. Like all consumption data analyses, they are gross with respect to non-participant spillover. For more detail, see Table 5-3 in Volume 4 of the IL-TRM. Consistent with Section 7.2 of the Illinois EE Policy Manual, applicable net-to-gross adjustments to these factors will be determined as part of the annual SAG net-to-gross process.

¹⁰¹⁹ F_e is estimated using TRM models for the three most popular building types for programmable thermostats: low-rise office (10.2%), sit-down restaurant (8.6%), and retail – strip mall (4.4%). 7.7% reflects the average F_e of the three building types. See "Fan Energy Factor Example Calculation 2021-06-23.xlsx" for reference.

¹⁰²⁰ Average capacity of 639 installs of thermostats on units <=10tons in Ameren Illinois territory installed from 2015-2020 and 706 installs on units <=10tons in ComEd territory in 2021.

¹⁰²¹ Calculated as the blend of heat pump and other central air conditioning (CAC) equipment in the East North Central census region as found in the 2012 Commercial Building Energy Consumption Survey (CBECS), where 4.5% of buildings with cooling systems able to be controlled by a smart thermostat utilize a heat pump with an assumed code baseline SEER of 13 (SEER2 12.4). This assumes a system capacity less than 65 kbtu/h. The remaining 94% of cooling systems are assumed to be split-system and single package CAC systems (<65 kbtu/h) with varying code SEER baselines. The 13.47 SEER / 12.8 SEER2 is the weighted average of cooling systems.

¹⁰²² Based on research conducted by Guidehouse on a sample of IL Small Commercial programmable thermostat installations, which found a range of savings values depending on the modeling assumptions used. Guidehouse recommended selecting the midpoint of this range, which it deemed preferable to continuing to rely on Residential assumptions, while also accounting for the relative uncertainties involved. See "Small Commercial Thermostats Research" memo completed in 2020.

Estimates of heating and cooling reduction factors are based on consumption data analyses with matching to non-participants and are therefore net with respect to participant spillover and between net and gross with respect to free ridership. Like all consumption data analyses, they are gross with respect to non-participant spillover. For more detail, see Table 5-3 in Volume 4 of the IL-TRM. Consistent with Section 7.2 of the Illinois EE Policy Manual, applicable net-to-gross adjustments to these factors will be determined as part of the annual SAG net-to-gross process.

- = 1.0, if the baseline thermostat was manual type
- = 0.6, if the baseline thermostat was programmable type¹⁰²³
- = 0.8, if the baseline is unknown¹⁰²⁴

For example, a thermostat installed in a Drug Store in Rockford with an electric heating system, replacing a manual type thermostat would have the following savings:

$$\begin{aligned} \Delta\text{kWh Heating} &= 1 * 114.5 * 1/5.1 * 2,848 * 8.8\% * 1 \\ &= 5,627 \\ \Delta\text{kWh Cooling} &= 61 * 1/12.4 * 858 * 17.7\% * 1 \\ &= 747 \\ \Delta\text{kWh} &= 5,627 + 747 \\ &= 6,374 \text{ kWh} \end{aligned}$$

SUMMER COINCIDENT PEAK DEMAND SAVINGS

$$\Delta\text{kW} = \text{kBtu/hr}_{\text{cool}} * 1/\text{EER2} * \text{Cooling_Reduction} * \text{BAF} * \text{CF}$$

Where:

EER2 = Energy Efficiency Ratio of the equipment
 = Actual, if unknown assume current Code. For midstream programs, assume a value of 10.9 EER2.¹⁰²⁵ For air-cooled units < 65 kBtu/hr, assume the following conversion from SEER to EER for calculation of peak savings:¹⁰²⁶

$$\text{EER} = (-0.02 * \text{SEER}^2) + (1.12 * \text{SEER})$$

CF_{SSP} = Summer System Peak Coincidence Factor for Commercial cooling (during system peak hour)
 = 45.7%¹⁰²⁷

CF_{PJM} = PJM Summer Peak Coincidence Factor for Commercial cooling (average during peak period)
 = 23.9%¹⁰²⁸

Other variables as provided above.

¹⁰²³ This factor represents the ratio of thermostat adjustment savings to thermostat replacement savings. It is based on actual thermostat algorithm data (i.e., degrees of setback, hours values, fan modes) from two years of ComEd AirCare Plus Program data (PY9+ and CY2018), including 382 thermostat adjustment installations and 3,847 thermostat replacement installations. An analysis of the data showed that on average, thermostat adjustments saved 61% and 59% of the thermostat replacement cooling savings and heating savings, respectively. For simplicity, a value of 0.6 was selected for both cooling and heating savings adjustment. See IL TRM Workpaper “4.4.48 Small Commercial Thermostats”, Guidehouse, 6/23/2021 for details.

¹⁰²⁴ Review of ComEd’s 2020 Baseline Study and 2019-2020 Program Data indicates that approximately half of installs are in buildings with existing manual thermostats, and half with existing programmable thermostats.

¹⁰²⁵ Calculated using the SEER to EER formula and assumed SEER of 13.47, converted to EER2.

¹⁰²⁶ Based on Wassmer, M. (2003). A Component-Based Model for Residential Air Conditioner and Heat Pump Energy Calculations. Masters Thesis, University of Colorado at Boulder. Note this is appropriate for single speed units only.

¹⁰²⁷ Based on analysis of Itron eShape data for Missouri, calibrated to Illinois loads, supplied by Ameren. The AC load during the utility’s peak hour is divided by the maximum AC load during the year. Multiplied by 50%.

¹⁰²⁸ Based on analysis of Itron eShape data for Missouri, calibrated to Illinois loads, supplied by Ameren. The average AC load over the PJM peak period (1-5pm, M-F, June through August) is divided by the maximum AC load during the year. Multiplied by 50%.

For example, a thermostat installed through a midstream program in a Drug Store in Rockford with an electric heating system, replacing a manual type thermostat would have the following savings during system peak hours:

$$\begin{aligned} \Delta kW &= 61 * 1/10.9 * 17.7\% * 1 * 45.7\% \\ &= 0.45 \text{ kW} \end{aligned}$$

FOSSIL FUEL SAVINGS

$$\Delta\text{Therms} = ((1 - \%ElectricHeat) * EFLH_{heat} * Capacity * 1/AFUE * Heating_Reduction * BAF) / 100,000\text{Btu/Therm}$$

Where:

Capacity = Nominal Heating Input Capacity (Btu/hr) of heating system
 = Actual

AFUE = Annual Fuel Utilization Efficiency Rating
 = Actual, if unknown assume code baseline. For midstream prorams, assume a value of 0.8.¹⁰²⁹

Other variables as provided above.

For Example, a thermostat installed through a midstream program in a Drug Store in Rockford with a gas heating system with a rated capacity of 60,000 Btu/hr, replacing a manual type thermostat would have the following savings:

$$\begin{aligned} \Delta\text{Therms} &= ((1 - 0) * 2,848 * 60,000 * 1 / 0.8 * 8.8\% * 1) / 100,000 \\ &= 188 \text{ Therms} \end{aligned}$$

WATER AND OTHER NON-ENERGY IMPACT DESCRIPTIONS AND CALCULATION

N/A

DEEMED O&M COST ADJUSTMENT CALCULATION

N/A

MEASURE CODE: CI-HVC-THST-V07-250101

REVIEW DEADLINE: 1/1/2029

¹⁰²⁹ Residential sized units (<225kbtu/h) as per Code of Federal Regulations, effective November, 2015 (10 CFR 432(e))

4.4.49 Boiler Chemical Descaling

DESCRIPTION

The measure is for a non-residential hot water or steam boiler serving process loads or one that provides space heating. Even with careful and precise water treatment in a boiler system, mineral scales are formed over time due to the high pressure and heat. Boiler scale is typically calcium, carbon, iron and silica particle deposits that form on the boiler tubes. Scale creates a problem because it typically possesses a thermal conductivity, an order of magnitude less than the corresponding value for bare steel. Even thin layers of scale serve as an effective insulator and inhibit heat transfer. The result is overheating of boiler tube metal, tube failures, and loss of energy efficiency.

De-scaling a boiler system will improve boiler efficiency by removing mineral scale build up on boiler tubes. De-scaling is done either through mechanical or chemical cleaning techniques. There are several limitations to mechanical cleaning, namely firetube boilers cannot be mechanically cleaned. Depending on the size of the boiler, it can take up to a week to mechanically clean the tubes. This measure applies to chemical de-scaling, which is an efficient alternative, since it is not plagued by these limitations. The procedure typically involves the boiler being emptied and taken off-line, following which, the correct chemical solution ratio is pumped through the boiler system for four to eight hours.

This measure was developed to be applicable to the following program types: RF. If applied to other program types, the measure savings should be verified.

DEFINITION OF EFFICIENT EQUIPMENT

To qualify for this measure, the facility must, as applicable, complete the chemical de-scaling by an approved technician and be NSF/ANSI/CAN 60 compliant.¹⁰³⁰

The efficient equipment is a boiler system which has been de-scaled using a chemical solution. After the cleaning is complete, the personnel have to ensure that all safety checks are completed including checks for leaks. Lastly, any remains of the descaling chemical solution have to be eliminated from the tubes by flushing the system with water and a blowdown.

DEFINITION OF BASELINE EQUIPMENT

The baseline condition is a boiler system that is compromised by scale build up.

DEEMED LIFETIME OF EFFICIENT EQUIPMENT

The lifetime of this measure varies based on the location of the site in Illinois. It has been established that the rate of scale buildup in hydronic systems is directly dependent on the hardness of the supply water (the amount of dissolved Calcium, Magnesium and Iron).¹⁰³¹ Based on an analysis of water supply composition in Illinois,¹⁰³² the estimated life of measure(in years) before requiring de-scaling is listed below:

Climate Zone	Measure Life of De-scaling
Rockford	2
Chicago	6
Springfield	2

¹⁰³⁰ NSF/ANSI/CAN 60 Standard: “If you manufacture, sell or distribute water treatment chemicals in North America, your products are required to comply with NSF/ANSI/CAN 60: Drinking Water Treatment Chemicals – Health Effects by most governmental agencies that regulate drinking water supplies.”

¹⁰³¹ ‘Study on Benefits of Removal of Water Hardness (Calcium and Magnesium Ions) from a Water Supply’, Battelle Memorial Institute, accessed April 2020.

¹⁰³² The Water Quality Reports from ‘Illinois American Water’ were analyzed for all five TRM zones in Illinois. Based on the water hardness level and Iron content, a correlation was made to the estimated usage of hydronic equipment before de-scaling is required. See page v of ‘Study on Benefits of Removal of Water Hardness (Calcium and Magnesium Ions) from a Water Supply’, Battelle Memorial Institute and “Water Quality Summary.xlsx” for reference.

Climate Zone	Measure Life of De-scaling
Belleville	3
Marion	3

DEEMED MEASURE COST

The cost of this measure is estimated to be \$378/MMBtu/hr per boiler.¹⁰³³

LOADSHAPE

N/A

COINCIDENCE FACTOR

N/A

Algorithm

CALCULATION OF ENERGY SAVINGS

ELECTRIC ENERGY SAVINGS

N/A

SUMMER COINCIDENT PEAK DEMAND SAVINGS

N/A

FOSSIL FUEL SAVINGS

$$\Delta\text{Therms} = (\text{Capacity} * \text{EFLH} * \%Ei) / 100,000$$

Where:

Capacity = Nominal Heating Input Capacity Boiler Size (Btu/hr) for boiler unit
 = Actual

EFLH = Equivalent Full Load Hours for heating in Existing Buildings are provided in section 4.4 HVAC End Use. For process loads, use custom hours.

%Ei = Percent efficiency improvement from chemical descaling
 = Dependent on system pressure and estimate of scale thickness. If unknown assume normal.¹⁰³⁴

¹⁰³³ Averaged from quotes from two chemical de-scaling solution manufacturers. Quote based on one day service with two personnel, including circulating pumps, tank assembly and other necessary fittings. Quotes based on pilot project study done by Nicor Gas Emerging Technology Program and Gas Technology Institute (GTI), “Descaling of Steam Boiler Systems”, 2019-2020. A 20% RYDLYME solution is assumed for cost, based on the pilot.

¹⁰³⁴ Estimates based on pilot project study done by Nicor Gas Emerging Technology Program and Gas Technology Institute (GTI), “Descaling of Steam Boiler Systems”, 2019-2020, and review of the following studies: ‘Clean Firetube Boiler Waterside Heat Transfer Surfaces’, U.S. Department of Energy, April 2012. ‘Energy Conservation Program Guide for Industry and Commerce’, NBS Handbook 115 Supplement 1, U.S. Department of Energy, December 1975, accessed April 2020.

Scale Thickness (inches)	Efficiency Improvement (%Ei)	
	Low Pressure (15psig and below) Applications	High Pressure (above 15psig) Applications
Low ($\leq 1/64$)	1%	1.6%
Normal ($\geq 1/32$ & $\leq 3/64$)	2.5%	3.9%
High ($\geq 1/16$)	3.9%	6.2%

100,000 = Converts Btu to Therms

For example, a 10,000 MBH firetube steam boiler in a Manufacturing facility in Rockford. The scaling on the tubes was estimated to be of 'normal' thickness and the steam supply was 'low pressure' at 15 psig.

$$\begin{aligned} \Delta\text{Therms} &= (\text{Capacity} * \text{EFLH} * \%Ei) / 100,000 \\ &= (10,000,000 * 1,048 * 0.025) / 100,000 \\ &= 2,620 \text{ Therms} \end{aligned}$$

WATER AND OTHER NON-ENERGY IMPACT DESCRIPTIONS AND CALCULATION

N/A

DEEMED O&M COST ADJUSTMENT CALCULATION

N/A

MEASURE CODE: CI-HVC-BCHD-V02-240101

REVIEW DEADLINE: 1/1/2029

4.4.50 Electric Chillers with Integrated Variable Speed Drives – Removed V12

4.4.51 Advanced Rooftop Controls with High Rotor Pole Switch Reluctance Motors

DESCRIPTION

A High Rotor Pole Switch Reluctance Motor (HRSRM) is a type of brushless DC electric motor that runs by reluctance torque. Unlike other DC motor types, power is delivered to windings in the stator rather than the rotor. This simplifies the mechanical design; power does not need to be delivered to a moving part, but requires a switching system through software control to deliver power to the different windings. Electronic devices can precisely time switch, facilitating HRSRM configurations.

In applications on rooftop units (RTUs), the HRSRM motor is comparable or more efficient than an RTU equipped with a variable speed drive supply fan. It results in fan-energy savings and can also include cooling savings if coupled with compressor or ventilation control, compared to a baseline scenario of constant-volume, constant-ventilation operation that is typical of single-zone, packaged HVAC units.

Fan energy savings come from the new integrated motor controls that allow for higher efficiency at varying loads and is achieved in all applications. Cooling savings can also be added from the effective use of variable speed or multi-stage cooling.

The markets that can be served by HRSRM motors are those which utilize RTUs, including but not limited to:

- 1 Fast-Service Restaurant
- 2 Full-Service Restaurant
- 3 Small Office
- 4 Stand-Alone Retail
- 5 Strip Mall
- 6 Warehouse

This measure was developed to be applicable to the following program types: NC, RF, EREP. If applied to other program types, the measure savings should be verified.

DEFINITION OF EFFICIENT EQUIPMENT

The efficient equipment is a single-zone, packaged HVAC unit with an existing functional integrated economizer that has been fitted with a HRSRM supply-fan and integrated speed control. This applies to both retrofit and new construction, and early replacement applications.

DEFINITION OF BASELINE EQUIPMENT

The baseline equipment is a single-zone, packaged HVAC unit (with an existing functional integrated economizer) that lacks demand-controlled ventilation controls and lacks supply-fan speed control via a variable-frequency drive.

DEEMED LIFETIME OF EFFICIENT EQUIPMENT

The expected measure life is assumed to be 12 years based on the HRSRM life.¹⁰³⁵

DEEMED MEASURE COST

Actual measure costs should be used if available. If costs are not available, the deemed measure cost below can be used. Material cost is based on the horsepower (hp) of the supply fan used in the RTU. Retrofit represents the full cost of the installation. New construction and early replacement represent the incremental cost of the motor itself on a new unit.¹⁰³⁶

¹⁰³⁵ Based on life cycle of a switch reluctance motor from P. Andrada, B. Blanque, E. Martinez, J.I. Perat, J.A. Sanchez, and M. Torrent, "Environmental and life cycle cost analysis of one switched reluctance motor drive and two inverter-fed induction motor drives," IET Electric Power Applications (2010): page 8.

¹⁰³⁶ Based on cost data from Turntide on HRSRM motors, <https://turntide.com>

Deemed Measure Cost Details

Type	HP	Material Cost	Labor Hours	Labor Rate	Deemed Cost
Retrofit	1	\$1,554.75	3	\$96.67	\$1,844.76
Retrofit	1.5	\$1,580.75	3	\$96.67	\$1,870.76
Retrofit	2	\$1,644.75	3	\$96.67	\$1,934.76
Retrofit	5	\$1,758.75	3	\$96.67	\$2,048.76
Retrofit	7.5	\$2,417.75	3	\$96.67	\$2,707.76
Retrofit	10	\$2,587.75	3	\$96.67	\$2,877.76
New Construction/Early Replacement	1	\$932.85	-	-	\$932.85
New Construction/Early Replacement	1.5	\$948.45	-	-	\$948.45
New Construction/Early Replacement	2	\$986.85	-	-	\$986.85
New Construction/Early Replacement	5	\$1,055.25	-	-	\$1,055.25
New Construction/Early Replacement	7.5	\$1,450.65	-	-	\$1,450.65
New Construction/Early Replacement	10	\$1,552.65	-	-	\$1,552.65

LOADSHAPE

Commercial ventilation C23

COINCIDENCE FACTOR

CF_{SSP} = Summer System Peak Coincidence Factor for Commercial cooling (during system peak hour)
 = 91.3%¹⁰³⁷

CF_{PJM} = PJM Summer Peak Coincidence Factor for Commercial cooling (average during peak period)
 = 47.8%¹⁰³⁸

¹⁰³⁷ Based on analysis of Itron eShape data for Missouri, calibrated to Illinois loads, supplied by Ameren. The AC load during the utility's peak hour is divided by the maximum AC load during the year.

¹⁰³⁸ Based on analysis of Itron eShape data for Missouri, calibrated to Illinois loads, supplied by Ameren. The average AC load over the PJM peak period (1-5pm, M-F, June through August) is divided by the maximum AC load during the year

Algorithm

CALCULATION OF ENERGY SAVINGS

Six different building types were selected for study. OpenStudio measures were used to generate ASHRAE 90.1-2013 code-compliant DOE prototype baseline models for each building type. The total conditioned area, the number of conditioned zones, and the peak cooling demand for each building are summarized in the following table.¹⁰³⁹

Selected DOE Prototype Buildings

Building Type	Small Office	Stand-Alone Retail	Warehouse	Strip Mall	Fast-Service Restaurant	Full-Service Restaurant
Conditioned Area (ft ²)	5,502	24,692	52,045	22,500	2,501	5,502
Number of Conditioned Zones	5	4	3	10	2	2
Total Fan Break Horsepower (BHP)	3.5	25	5	23	7	11
Design Cooling Load (Ton)	8.5	65	13	69	20	33

In order to achieve savings, the RTU control options consist of following modes:

1. Ventilation Mode:
 - a. Outdoor air is at a minimum for building type
 - b. Fan speed set to 40%
 - c. Heating and cooling coils are off
2. Economizer Mode
 - a. Outdoor air rate was set from 40% and increased as needed to satisfy indoor air temperature
 - b. When outdoor air could no longer satisfy cooling, cooling mode was staged on
3. Mechanical Cooling Mode
 - a. Outdoor air is at a minimum for building type
 - b. Compressors (if multiple or variable) were staged/modulated to meet setpoint temperature of the space
 - c. Supply fan set to 100%
4. Heating mode
 - a. Outdoor air is at a minimum for building type
 - b. Heating coil staged as necessary
 - c. Supply fan set to 100%

The models produced a percentage energy savings based on using a HRSRM fan and varying compressor types. Retrofit savings include fan only. For new construction and early replacement, savings are based on compressor type and energy efficiency of the unit. These RTU control options are reflected in the table below. As a correction to these entries, a second set of single two-stage compressor RTU fan options are also reflected in the *Energy Savings Type: ESF_Fan* entry in the table below¹⁰⁴⁰ and are characterized by the following speed settings:

1. Ventilation Mode:
 - a. Outdoor air is at a minimum for building type
 - b. Supply fan set to 40%
 - c. Heating and cooling coils are off

¹⁰³⁹ Korbaga Woldekidan, Daniel Studer, and Ramin Faramarzi, “Performance Evaluation of Three RTU Energy Efficiency Technologies,” 2019.

¹⁰⁴⁰ Lick, A., A. Cardiel, J. Zhou, S. Hackel, S. Pigg, and K. Gries. “Switched-Reluctance Motor Field Evaluation Final Report.” Slipstream project report for the ComEd Energy Efficiency Program. March 25, 2022. <https://comedemergingtech.com/project/srm-field-evaluation>

2. Economizer Mode:
 - a. No change compared to existing RTU settings
3. Mechanical Cooling Mode (Stage 1):
 - a. Outdoor air is at a minimum for building type
 - b. Compressor stage 1 ON
 - c. Supply fan set to 75%
4. Mechanical Cooling Mode (Stage 2):
 - a. Outdoor air is at a minimum for building type
 - b. Compressor stage 1 & 2 ON
 - c. Supply fan set to 90%
5. Heating Mode:
 - a. Outdoor air is at a minimum for building type
 - b. Heating coil staged as necessary
 - c. Supply fan set to 90%

ELECTRIC ENERGY SAVINGS

For units with cooling capacities less than 65 kBtu/hr:

$$\Delta\text{kWH} = (\text{kBtu/hr}) * (1/ \text{SEER}_{\text{exist}}) * \text{EFLH} * \text{ESF}_{\text{Cooling}} + 0.746 * \text{FanHP} * (\text{LF}/\eta_{\text{motor}}) * \text{RunHours} * \text{ESF}_{\text{Fan}}$$

For units with cooling capacities equal to or greater than 65 kBtu/hr:

$$\Delta\text{kWH} = (\text{kBtu/hr}) * (1/\text{IEER}_{\text{exist}}) * \text{EFLH} * \text{ESF}_{\text{Cooling}} + 0.746 * \text{FanHP} * (\text{LF}/\eta_{\text{motor}}) * \text{RunHours} * \text{ESF}_{\text{Fan}}$$

Where:

kBtu/hr	= capacity of the cooling equipment in kBtu per hour (1 ton of cooling capacity equals 12 kBtu/hr)
SEER _{exist}	= Seasonal Energy Efficiency Ratio of the existing equipment = Actual. Or assume Code base in place at the original time of existing unit installation. IECC 2018 (effective July 1, 2019 to December 31, 2023) and IECC 2021 (effective statewide January 1, 2024) provided below for referenced. As code requirements and adoption can differ from municipality to municipality, the user should verify which version of code is applicable given these constraints.
IEER _{exist}	= Integrated Energy Efficiency Ratio of the existing equipment = Actual. Or assume Code base in place at the original time of existing unit installation. IECC 2018 (effective July 1, 2019 to December 31, 2023) and IECC 2021 (effective statewide in January 1, 2024) provided below for reference. As code requirements and adoption can differ from municipality to municipality, the user should verify which version of code is applicable given these constraints.
EFLH	= Equivalent Full Load Hours for cooling in Existing Buildings or New Construction are provided in Illinois TRM version 8.0 section 4.4 HVAC End Use
ESF _{Cooling}	= Energy savings factor for cooling as found in Error! Reference source not found. ¹⁰⁴¹
ESF _{Fan}	= Energy savings factor for cooling as found in table below ¹⁰⁴²

¹⁰⁴¹ Average cooling savings for all building types from paper entitled “Performance Evaluation of Three RTU Energy Efficiency Technologies”, NREL and ComEd, December 2020. Savings averaged by RTU compressor type.

¹⁰⁴² Based on forthcoming ComEd Field Study (final results TBD)

Energy Savings Factors

Energy Savings Type	Retrofit Type	HRSRM on Single Stage Compressor	HRSRM on Single Two Stage Compressor	HRSRM on Variable Speed Compressor
ESF_Cooling ¹⁰⁴³	New Construction/Early Replacement	0%	0%	0%
ESF_Cooling ¹⁰⁴⁴	Supply Fan Retrofit Only	0.0%	0.0%	0.0%
ESF_Fan ¹⁰⁴⁴	New Construction/Early Replacement	46.6%	61.0%	64.8%
ESF_Fan ¹⁰⁴⁴	Supply Fan Retrofit Only	46.6%	61.0%	64.8%

FanHP = Horsepower of fan in RTU

= Actual

LF = Load Factor; Motor Load at Fan Design CFM (Default = 65%)¹⁰⁴⁵

η_{motor} = Installed nominal/nameplate motor efficiency

Default motor is a NEMA Premium efficiency, ODP, 4-pole/1800 RPM fan motor

NEMA Premium Efficiency Motors Default Efficiencies¹⁰⁴⁶

Size HP	Open Drip Proof (ODP)			Totally Enclosed Fan-Cooled (TEFC)		
	# of Poles			# of Poles		
	6	4	2	6	4	2
	Speed (RPM)			Speed (RPM)		
	1200	1800 Default	3600	1200	1800	3600
1	0.825	0.855	0.770	0.825	0.855	0.770
1.5	0.865	0.865	0.840	0.875	0.865	0.840
2	0.875	0.865	0.855	0.885	0.865	0.855
3	0.885	0.895	0.855	0.895	0.895	0.865
5	0.895	0.895	0.865	0.895	0.895	0.885
7.5	0.902	0.910	0.885	0.910	0.917	0.895
10	0.917	0.917	0.895	0.910	0.917	0.902
15	0.917	0.930	0.902	0.917	0.924	0.910
20	0.924	0.930	0.910	0.917	0.930	0.910
25	0.930	0.936	0.917	0.930	0.936	0.917
30	0.936	0.941	0.917	0.930	0.936	0.917
40	0.941	0.941	0.924	0.941	0.941	0.924
50	0.941	0.945	0.930	0.941	0.945	0.930
60	0.945	0.950	0.936	0.945	0.950	0.936

¹⁰⁴³ Energy savings in this row only are due to control of the RTU that goes beyond solely fan motor replacement and utilizes additional control like ventilation or compressor control. Measures should incorporate additional control to claim savings here. See related footnotes for details.

¹⁰⁴⁴ The numbers in the “HRSRM on Single Two Stage Compressor” column are based on the field study “Switched-Reluctance Motor Field Evaluation Final Report”, Prepared for ComEd by Slipstream, March 25, 2022. The numbers in the other two columns are based on the field study and the simulation study “Performance Evaluation of Three RTU Energy Efficiency Technologies”, NREL and ComEd, December 2020.

¹⁰⁴⁵ Lawrence Berkeley National Laboratory, and Resource Dynamics Corporation. (2008). “Improving Motor and Drive System Performance; A Sourcebook for Industry”. U.S. Department of Energy, Office of Energy Efficiency and Renewable Energy. Golden, CO: National Renewable Energy Laboratory.

¹⁰⁴⁶ Douglass, J. (2005). Induction Motor Efficiency Standards. Washington State University and the Northwest Energy Efficiency Alliance, Extension Energy Program, Olympia, WA, October 2005.

Size HP	Open Drip Proof (ODP)			Totally Enclosed Fan-Cooled (TEFC)		
	# of Poles			# of Poles		
	6	4	2	6	4	2
	Speed (RPM)			Speed (RPM)		
	1200	1800 Default	3600	1200	1800	3600
75	0.945	0.950	0.936	0.945	0.954	0.936
100	0.950	0.954	0.936	0.950	0.954	0.941
125	0.950	0.954	0.941	0.950	0.954	0.950
150	0.954	0.958	0.941	0.958	0.958	0.950
200	0.954	0.958	0.950	0.958	0.962	0.954
250	0.954	0.958	0.950	0.958	0.962	0.958
300	0.954	0.958	0.954	0.958	0.962	0.958
350	0.954	0.958	0.954	0.958	0.962	0.958
400	0.958	0.958	0.958	0.958	0.962	0.958
450	0.962	0.962	0.958	0.958	0.962	0.958
500	0.962	0.962	0.958	0.958	0.962	0.958

RunHours = Annual operating hours for fan motor based on building type
 = Default hours are provided for HVAC applications which vary by HVAC application and building type in the following table.¹⁰⁴⁷ When available, actual hours should be used.

Building Type	Total Fan Run Hours	Model Source
Assembly	7,235	eQuest
Assisted Living	8,760	eQuest
Auto Dealership	7,451	OpenStudio
College	4,836	OpenStudio
Convenience Store	7,004	eQuest
Drug Store	7,156	OpenStudio
Elementary School	3,765	OpenStudio
Emergency Services	8,760	OpenStudio
Garage	7,357	eQuest
Grocery	8,543	OpenStudio
Healthcare Clinic	4,314	OpenStudio
High School	3,460	OpenStudio
Manufacturing Facility	8,706	eQuest
MF – High Rise	8,760	OpenStudio
MF – Mid Rise	8,760	OpenStudio
Hotel/Motel – Guest	2,409	OpenStudio
Hotel/Motel – Common	8,683	OpenStudio
Movie Theater	7,505	eQuest
Office – Low Rise	6,345	OpenStudio
Office – Mid Rise	3,440	OpenStudio
Religious Building	7,380	eQuest
Restaurant	7,302	OpenStudio
Retail – Department Store	7,155	OpenStudio
Retail – Strip Mall	6,921	OpenStudio
Warehouse	6,832	OpenStudio

¹⁰⁴⁷ Hours per year are estimated using the eQuest or OpenStudio models as the total number of hours the fans are operating for heating, cooling, and ventilation for each building type.

Building Type	Total Fan Run Hours	Model Source
Unknown	6,241	n/a

2018 IECC Minimum Efficiency Requirements

TABLE C403.3.2(1)
MINIMUM EFFICIENCY REQUIREMENTS: ELECTRICALLY OPERATED UNITARY AIR CONDITIONERS AND CONDENSING UNITS

EQUIPMENT TYPE	SIZE CATEGORY	HEATING SECTION TYPE	SUBCATEGORY OR RATING CONDITION	MINIMUM EFFICIENCY	TEST PROCEDURE ^a		
Air conditioners, air cooled	< 65,000 Btu/h ^b	All	Split System	13.0 SEER	AHRI 210/240		
			Single Package	14.0 SEER			
Through-the-wall (air cooled)	≤ 30,000 Btu/h ^b	All	Split system	12.0 SEER			
			Single Package	12.0 SEER			
Small-duct high-velocity (air cooled)	< 65,000 Btu/h ^b	All	Split System	11.0 SEER			
Air conditioners, air cooled	≥ 65,000 Btu/h and < 135,000 Btu/h	Electric Resistance (or None)	Split System and Single Package	11.2 EER 12.8 IEER		AHRI 340/360	
		All other	Split System and Single Package	11.0 EER 12.6 IEER			
	≥ 135,000 Btu/h and < 240,000 Btu/h	Electric Resistance (or None)	Split System and Single Package	11.0 EER 12.4 IEER			
		All other	Split System and Single Package	10.8 EER 12.2 IEER			
	≥ 240,000 Btu/h and < 760,000 Btu/h	Electric Resistance (or None)	Split System and Single Package	10.0 EER 11.6 IEER			
		All other	Split System and Single Package	9.8 EER 11.4 IEER			
	≥ 760,000 Btu/h	Electric Resistance (or None)	Split System and Single Package	9.7 EER 11.2 IEER			
		All other	Split System and Single Package	9.5 EER 11.0 IEER			
	Air conditioners, water cooled	< 65,000 Btu/h ^b	All	Split System and Single Package	12.1 EER 12.3 IEER		AHRI 210/240
		≥ 65,000 Btu/h and < 135,000 Btu/h	Electric Resistance (or None)	Split System and Single Package	12.1 EER 13.9 IEER		AHRI 340/360
All other			Split System and Single Package	11.9 EER 13.7 IEER			
≥ 135,000 Btu/h and < 240,000 Btu/h		Electric Resistance (or None)	Split System and Single Package	12.5 EER 13.9 IEER			
		All other	Split System and Single Package	12.3 EER 13.7 IEER			
≥ 240,000 Btu/h and < 760,000 Btu/h		Electric Resistance (or None)	Split System and Single Package	12.4 EER 13.6 IEER			
		All other	Split System and Single Package	12.2 EER 13.4 IEER			
≥ 760,000 Btu/h		Electric Resistance (or None)	Split System and Single Package	12.2 EER 13.5 IEER			
		All other	Split System and Single Package	12.0 EER 13.3 IEER			

Illinois Statewide Technical Reference Manual – 4.4.51 Advanced Rooftop Controls with High Rotor Pole Switch Reluctance Motors

Air conditioners, evaporatively cooled	< 65,000 Btu/h ^b	All	Split System and Single Package	12.1 EER 12.3 IEER	AHRI 210/240
	≥ 65,000 Btu/h and < 135,000 Btu/h	Electric Resistance (or None)	Split System and Single Package	12.1 EER 12.3 IEER	AHRI 340/360
		All other	Split System and Single Package	11.9 EER 12.1 IEER	
	≥ 135,000 Btu/h and < 240,000 Btu/h	Electric Resistance (or None)	Split System and Single Package	12.0 EER 12.2 IEER	
		All other	Split System and Single Package	11.8 EER 12.0 IEER	
	≥ 240,000 Btu/h and < 760,000 Btu/h	Electric Resistance (or None)	Split System and Single Package	11.9 EER 12.1 IEER	
		All other	Split System and Single Package	11.7 EER 11.9 IEER	
	≥ 760,000 Btu/h	Electric Resistance (or None)	Split System and Single Package	11.7 EER 11.9 IEER	
All other		Split System and Single Package	11.5 EER 11.7 IEER		
Condensing units, air cooled	≥ 135,000 Btu/h	—	—	10.5 EER 11.8 IEER	AHRI 365
Condensing units, water cooled	≥ 135,000 Btu/h	—	—	13.5 EER 14.0 IEER	
Condensing units, evaporatively cooled	≥ 135,000 Btu/h	—	—	13.5 EER 14.0 IEER	

For SI: 1 British thermal unit per hour = 0.2931 W.

- a. Chapter 6 contains a complete specification of the referenced test procedure, including the reference year version of the test procedure.
- b. Single-phase, air-cooled air conditioners less than 65,000 Btu/h are regulated by NAECA. SEER values are those set by NAECA.

2021 IECC Minimum Efficiency Requirements

TABLE C403.3.2(1)
ELECTRICALLY OPERATED UNITARY AIR CONDITIONERS AND CONDENSING UNITS—MINIMUM EFFICIENCY REQUIREMENTS^{a, d}

EQUIPMENT TYPE	SIZE CATEGORY	HEADING SECTION TYPE	SUBCATEGORY OR RATING CONDITION	MINIMUM EFFICIENCY	TEST PROCEDURE ^a
Air conditioners, air cooled	< 65,000 Btu/h ^b	All	Split system, three phase and applications outside US single phase ^b	13.0 SEER before 1/1/2023 13.4 SEER ₂ after 1/1/2023	AHRI 210/240—2017 before 1/1/2023
			Single-package, three phase and applications outside US single phase ^b	14.0 SEER before 1/1/2023 13.4 SEER ₂ after 1/1/2023	AHRI 210/240—2023 after 1/1/2023
Space constrained, air cooled	≤ 30,000 Btu/h ^b	All	Split system, three phase and applications outside US single phase ^b	12.0 SEER before 1/1/2023 11.7 SEER ₂ after 1/1/2023	AHRI 210/240—2017 before 1/1/2023
			Single package, three phase and applications outside US single phase ^b	12.0 SEER before 1/1/2023 11.7 SEER ₂ after 1/1/2023	AHRI 210/240—2023 after 1/1/2023
Small duct, high velocity, air cooled	< 65,000 Btu/h ^b	All	Split system, three phase and applications outside US single phase ^b	12.0 SEER before 1/1/2023 12.1 SEER ₂ after 1/1/2023	AHRI 210/240—2017 before 1/1/2023 AHRI 210/240—2023 after 1/1/2023
Air conditioners, air cooled	≥ 65,000 Btu/h and < 135,000 Btu/h	Electric resistance (or none)	Split system and single package	11.2 EER 12.9 IEER before 1/1/2023 14.8 IEER after 1/1/2023	AHRI 340/360
		All other		11.0 EER 12.7 IEER before 1/1/2023 14.6 IEER after 1/1/2023	
	Electric resistance (or none)	11.0 EER 12.4 IEER before 1/1/2023 14.2 IEER after 1/1/2023			
	All other	10.8 EER 12.2 IEER before 1/1/2023 14.0 IEER after 1/1/2023			
≥ 135,000 Btu/h and < 240,000 Btu/h					

TABLE C403.3.2(1)—continued
ELECTRICALLY OPERATED UNITARY AIR CONDITIONERS AND CONDENSING UNITS—MINIMUM EFFICIENCY REQUIREMENTS^{a, d}

EQUIPMENT TYPE	SIZE CATEGORY	HEADING SECTION TYPE	SUBCATEGORY OR RATING CONDITION	MINIMUM EFFICIENCY	TEST PROCEDURE ^e
Air conditioners, air cooled (continued)	≥ 240,000 Btu/h and < 760,000 Btu/h	Electric resistance (or none)	Split system and single package	10.0 EER 11.6 IEER before 1/1/2023 13.2 IEER after 1/1/2023	AHRI 340/360
		All other		9.8 EER 11.4 IEER before 1/1/2023 13.0 IEER after 1/1/2023	
	≥ 760,000 Btu/h	Electric resistance (or none)		9.7 EER 11.2 IEER before 1/1/2023 12.5 IEER after 1/1/2023	
		All other		9.5 EER 11.0 IEER before 1/1/2023 12.3 IEER after 1/1/2023	
Air conditioners, water cooled	< 65,000 Btu/h	All	Split system and single package	12.1 EER 12.3 IEER	AHRI 210/240
	≥ 65,000 Btu/h and < 135,000 Btu/h	Electric resistance (or none)		12.1 EER 13.9 IEER	AHRI 340/360
		All other		11.9 EER 13.7 IEER	
	≥ 135,000 Btu/h and < 240,000 Btu/h	Electric resistance (or none)		12.5 EER 13.9 IEER	
		All other		12.3 EER 13.7 IEER	
	≥ 240,000 Btu/h and < 760,000 Btu/h	Electric resistance (or none)		12.4 EER 13.6 IEER	
		All other		12.2 EER 13.4 IEER	
	≥ 760,000 Btu/h	Electric resistance (or none)		12.2 EER 13.5 IEER	
All other		12.0 EER 13.3 IEER			

TABLE C403.3.2(1)—continued
ELECTRICALLY OPERATED UNITARY AIR CONDITIONERS AND CONDENSING UNITS—MINIMUM EFFICIENCY REQUIREMENTS^{a, d}

EQUIPMENT TYPE	SIZE CATEGORY	HEADING SECTION TYPE	SUBCATEGORY OR RATING CONDITION	MINIMUM EFFICIENCY	TEST PROCEDURE ^a
Air conditioners, evaporatively cooled	< 65,000 Btu/h ^b	All	Split system and single package	12.1 EER 12.3 IEER	AHRI 210/240
	≥ 65,000 Btu/h and < 135,000 Btu/h	Electric resistance (or none)		12.1 EER 12.3 IEER	AHRI 340/360
		All other		11.9 EER 12.1 IEER	
	≥ 135,000 Btu/h and < 240,000 Btu/h	Electric resistance (or none)		12.0 EER 12.2 IEER	
		All other		11.8 EER 12.0 IEER	
	≥ 240,000 Btu/h and < 760,000 Btu/h	Electric resistance (or none)		11.9 EER 12.1 IEER	
		All other		11.7 EER 11.9 IEER	
	≥ 760,000 Btu/h	Electric resistance (or none)		11.7 EER 11.9 IEER	
All other		11.5 EER 11.7 IEER			
Condensing units, air cooled	≥ 135,000 Btu/h	—	—	10.5 EER 11.8 IEER	AHRI 365
Condensing units, water cooled	≥ 135,000 Btu/h	—	—	13.5 EER 14.0 IEER	AHRI 365
Condensing units, evaporatively cooled	≥ 135,000 Btu/h	—	—	13.5 EER 14.0 IEER	AHRI 365

SUMMER COINCIDENT PEAK DEMAND SAVINGS

$$\Delta kW = [(kBtu/hr) * (1/EER_{exist}) * ESF_{Cooling} + 0.746 * FanHP * (LF/\eta_{motor}) * ESF_{Fan}] * CF$$

Where:

- EER_{exist} = Energy Efficiency Ratio of the existing equipment (assume the following conversion from SEER to EER for calculation of peak savings: EER = (-0.02 * SEER²) + (1.12 * SEER))
= Actual, or assume Code base in place at the original time of existing unit installation
- CF_{SSP} = Summer System Peak Coincidence Factor for Commercial cooling (during system peak hour)
= 91.3%
- CF_{PJM} = PJM Summer Peak Coincidence Factor for Commercial cooling (average during peak period)
= 47.8%

FOSSIL FUEL SAVINGS

N/A

WATER AND OTHER NON-ENERGY IMPACT DESCRIPTIONS AND CALCULATION

N/A

DEEMED O&M COST ADJUSTMENT CALCULATION

N/A

MEASURE CODE: CI-HVC-HSRM-V06-250101

REVIEW DEADLINE: 1/1/2028

4.4.52 Hydronic Heating Radiator Replacement

DESCRIPTION

A hydronic heating radiator's capacity to evenly and consistently distribute heat throughout a space, utilizing piped hot-water or steam is often stymied by the buildup of mineral deposits and contaminants. Past research has shown that eliminating these deposits regularizes flow rate and boiler behavior, in effect restoring a radiator to a like-new condition.¹⁰⁴⁸ A space is heated more effectively in this improved state and this condition furthermore reduces the need for continual (additionally wasteful) thermostat readjustment. A straightforward process to achieve this is to simply replace the fouled hydronic radiator pipe system with a new system equivalent to the replaced system's pre-fouled performance levels. This avoids any possible inconsistencies associated with a radiator-flushing procedure (e.g., less-than-expected savings, failure to return the pipe system to like-new condition, inability to treat a system due to its interlinking with separate domestic hot water systems, etc.) and furthermore ensures that expected savings are realized. This measure offers benefits during heating seasons for natural gas, is applicable to both residential and commercial applications, and considers hot water or steam as the source of thermal energy (seeing as both heat transfer mediums can theoretically act as the intermediary from which contaminants precipitate).

The calculations of savings presented in this section are furthermore normalized to apply to both commercial and multi-family residential applications and additionally consider the differences between the physical characteristics of hot water or steam (e.g., thermal resistance, temperature, convective heat transfer) when computing the savings tabulated in the 'Annual Normalized Gas Savings per Surface Area' table shown below.

This measure was developed to be applicable to the following program types: RF

If applied to other program types, the measure savings should be verified.

DEFINITION OF EFFICIENT EQUIPMENT

The efficient equipment is a new replacement hydronic radiator free of mineral deposit scaling and/or sludge which must reflect the capacity of the replaced system's pre-fouled performance levels (i.e., a "like-for-like" replacement).

DEFINITION OF BASELINE EQUIPMENT

The baseline condition is the hydronic radiator being replaced, which has shown decreased performance due to a high degree of mineral deposit scaling and sludge buildup. The built-up scale inside the radiators is predominantly assumed to be Iron Oxide (Fe_3O_4) and to have a thermal conductivity of 3.01 Btu/hr-ft \cdot °F.¹⁰⁴⁹

A "standard scaled" radiator is assumed to be 10% clogged and a "heavily scaled" radiator is assumed to be 30% clogged. An implementation contractor will need to verify the baseline condition of the radiator, to classify it as either standard or heavily scaled. Measuring the surface temperature spread using an infrared temperature thermometer can be used to determine this; surface temperature spot readings below 180°F for a steam system and below 100°F for a hot water system can be labeled as 'standard scaling'. A "heavily scaled" radiator is assumed to one with surface temperature spots below 150°F for a steam system and below 90°F for a hot water system.¹⁰⁵⁰ This should be verified by the implementation contractor by measuring the radiator surface temperature at multiple points when operating the boiler system at full load and when outdoor air temperatures are below 20°F. Implementer should strive to perform spot readings on at least 10% of total radiators. Based on the collected spot temperature readings, qualify the facility as either standard scaled or heavily scaled.

¹⁰⁴⁸ Day, Paul and Balmer, Paul. "Independent Study Shows Sludge Build-up Significantly Affects Hydronic Heating System Performance," May, 2011. Accessed 03/25/20.

¹⁰⁴⁹ The thermal properties of Iron Oxide are referenced from the following: Takeda, Mikako and Onishi, Takashi and Nakakubo, Shouhei and Fujimoto, Shinji. "Physical Properties of Iron-Oxide Scales on Si-Containing Steels at High Temperature," Materials Transactions Vol 50, No. 9 (2009): pp. 2242-2246. doi:10.2320/matertrans.M2009097.

¹⁰⁵⁰ Assumptions based on typical operating hot water/steam supply temperatures for cast-iron radiators of 170°F and 220°F. 'Clogged' surface temperature assumptions based on temperatures below which performance of radiators starts dropping considerably.

The baseline for this measure is aging scaled radiators. Most facilities tend not to replace their old radiators and often tend to add a means of secondary heating. This measure is aimed at these facilities to incentivize the replacement of these old radiators.

DEEMED LIFETIME OF EFFICIENT EQUIPMENT

Hydronic radiator systems are extremely diverse, in size, scope or application, and in the materials utilized for the heat transfer surface. Cast iron, steel, and copper piping are common in radiators, as are polymer materials such as polyethylene (often seen in newer radiator systems). As such, an estimated useful life will naturally vary based on these circumstances and the quality of previous radiator maintenance. The estimated useful life of a typical hydronic radiator has been approximated to be 25 years.¹⁰⁵¹

DEEMED MEASURE COST

The measure cost is the full cost of removing the existing unit and installing a new one. The actual program cost should be used. If unknown, assume \$61.35 per vertical column.¹⁰⁵² For more details on the definition of section of a radiator, the cited reference can be used.¹⁰⁵³

LOADSHAPE

N/A

COINCIDENCE FACTOR

N/A

Algorithm

CALCULATION OF ENERGY SAVINGS

ELECTRIC ENERGY SAVINGS

N/A

SUMMER COINCIDENT PEAK DEMAND SAVINGS

N/A

FOSSIL FUEL SAVINGS

The annual natural gas savings per area for radiator replacement is calculated by determining the difference between the heat transfer from the replacement radiator and the radiator being replaced.

$$\Delta Therms = \frac{[(Q_{New} - Q_{Base}) * EFLH]}{(100,000 * \eta)}$$

¹⁰⁵¹ Examples from the following source use “system design lives” of 20 and 25 years, and cite the service lifetimes of a cast iron hydronic radiator’s boiler to often be “30 years or more”.

Siegenthaler, John, Modern Hydronic Heating: For Residential and Light Commercial Buildings 3rd Edition, Delmar Cengage Learning, Clifton Park, New York, 2012.

There is limited information available on system lifetimes of hydronic radiators, as well-built and well-maintained systems tend to last for decades. We assume that a midpoint of the “design-lives” cited above (25) can correspond to the time a hydronic radiator system begins to underperform, with one known reason for underperformance (which also happens to be the focus of this measure) being the corrosion of piping materials and/or the presence of precipitated mineral contaminates restricting flow rate and thus hindering heat transfer.

¹⁰⁵² Average calculated from RSMeans Cost Data 2020 for Hydronic Heating Radiators, Cast Iron.

¹⁰⁵³ Express Radiant, “Calculating Radiator Output”, 2014. This reference shows a representation of how a section of a typical radiator is defined.

$$Q_{Base} = \frac{(A * \Delta T)}{R_{Base}}$$

$$R_{Base} = R_{conv1} + R_{cond} + \left(\frac{R_{rad} * R_{conv2}}{R_{rad} + R_{conv2}} \right)$$

$$Q_{New} = \frac{(A * \Delta T)}{R_{New}}$$

The thermal resistance components remain the same as the above (R_{Base}), with the exception of the contaminate oxide layer which is no longer present in the post-case:

$$R_{New} = R_{conv1} + \left(\frac{R_{rad} * R_{conv2}}{R_{rad} + R_{conv2}} \right)$$

Where:

- Q_{New} (Btu/hr) = The heat emission from the replacement hydronic heating system
- Q_{Base} (Btu/hr) = The heat emission from the hydronic heating system being replaced
- $EFLH$ = Effective full load hours based on the climate zone

Heating Season Recirculation Hours

Climate Zone	Hours
1 – Rockford	5,039
2 – Chicago	4,963
3 – Springfield	4,495
4 – Belleville	4,021
5 – Marion	4,150

- η = Actual Thermal Efficiency of the Heating Equipment (if unknown, use 81.9% for water boilers¹⁰⁵⁴ and 80.7% for steam boilers¹⁰⁵⁵)
- 100,000 = conversion factor (1 Therm = 100,000 Btu)
- A (ft²) = the effective area of heat transfer of the radiator¹⁰⁵⁶
- ΔT (°F) = the temperature difference between the supply fluid temperature and the conditioned room design temperature
- R_{Base} (ft² °F hr/ BTU) = the overall thermal resistance of the system before replacement
- R_{New} (ft² °F hr/ BTU) = the overall thermal resistance of the system after replacement
- R_{conv1} (ft² °F hr/ BTU) = the thermal resistance of convection between the hot water/steam and the radiator¹⁰⁵⁷

¹⁰⁵⁴ Average efficiencies of units from the California Energy Commission (CEC).

¹⁰⁵⁵ Ibid.

¹⁰⁵⁶ The pipe diameter is assumed to be 2 inches and the thickness of mineral deposits in a fouled radiator (which, recall, are assumed to be composed of iron oxide), is a function of the percent of the pipe diameter which is clogged and the assumed pipe diameter.

¹⁰⁵⁷ For a steam system, the supply temperature is assumed to be 220°F. For a hot water system, the supply temperature is assumed to be 170°F. This implies convective heat transfer coefficients of 1,100 Btu/hr-ft²-°F and 700 Btu/hr-ft²-°F for steam and hot water, respectively, the inverses of which equate to steam’s or hot water’s thermal resistances.

R_{cond} (ft² °F hr/ BTU) = the thermal resistance of conduction in the oxide layer buildup¹⁰⁵⁸

R_{rad} (ft² °F hr/ BTU) = the thermal resistance of radiation between the radiator and the conditioned space¹⁰⁵⁹

R_{conv2} (ft² °F hr/ BTU) = the thermal resistance of convection between radiator and the conditioned space¹⁰⁶⁰

Annual Normalized Gas Savings per Surface Area (therms/ft²)

HVAC System Type		1 – Rockford	2 – Chicago	3 – Springfield	4 – Belleville	5 – Marion
Hot Water Radiator	Standard Scaling	0.115	0.113	0.102	0.091	0.094
	Heavy Scaling	0.337	0.332	0.301	0.269	0.278
Steam Radiator	Standard Scaling	0.170	0.168	0.152	0.136	0.140
	Heavy Scaling	0.501	0.493	0.447	0.400	0.413

$$\Delta Therms = HS_{cz} * Area_{radiator}$$

Where:

HS_{cz} = Annual heating savings per area of radiator by climate zone, values from ‘Annual Normalized Gas Savings per Surface Area’ table above.

$Area_{radiator}$ = Total surface area of radiator (ft²)

Example:

For example, a building in Climate Zone 1 is equipped with a heavily scaled steam radiator system. The surface area of the replacement and radiator being replaced was calculated to be 85 ft².

$\Delta Therms$ = Annual Normalized Gas Savings (therms/ft²) * Surface Area (ft²)

= 0.501 * 85

= 42.59 therms annually

WATER AND OTHER NON-ENERGY IMPACT DESCRIPTIONS AND CALCULATION

N/A

DEEMED O&M COST ADJUSTMENT CALCULATION

N/A

MEASURE CODE: CI-HVC-HHRR-V02-240101

REVIEW DEADLINE: 1/1/2028

¹⁰⁵⁸ Recall that iron oxide has a thermal conductivity of 3.01 Btu/hr-ft²-°F.

¹⁰⁵⁹ Stefan-Boltzmann constant is assumed to be 1.714x10⁻⁹ BTU·hr⁻¹·ft⁻²·°R⁻⁴.

¹⁰⁶⁰ The convective heat transfer coefficient of Air is assumed to be 1.844 Btu/hr-ft²-°F. Emissivity of radiator surface is assumed to be 0.6.

4.4.53 HVAC Supply, Return and Exhaust Fans – Fan Energy Index

DESCRIPTION

The Fan Energy Index (FEI) is a new fan efficiency metric that allows for the comparison of different fans at application specific operating conditions. This is a significant improvement over the current Fan Efficiency Grade metric, which is defined at a rated condition. FEI is incorporated in ASHRAE 90.1-2019 and IECC-2021. These codes set the baseline FEI as 1.0 for constant speed fan operation and 0.95 for variable speed fan operation. More efficient fans will have FEI greater than these values. It is only applicable to stand-alone fans, and not for fans embedded in packaged equipment. This measure results in fan energy savings compared to a baseline scenario of an existing fan's FEI or code minimum FEI for a new fan.

Note this measure should be used for evaluating more efficient over baseline fans with the same control system. Measure 4.4.26 should be utilized to evaluate control system modifications. When combining the two measures, the FEP_{New} value should be used to replace the $\left(0.746 \times HP \times \frac{LF}{\eta_{motor}}\right)$ term in Measure 4.4.26 Variable Speed Drive for HVAC Supply and Return Fans.

This measure serves the market for commercial and industrial buildings.

This measure was developed to be applicable to the following program types: TOS, NC, and EREP. If applied to other program types, the measure savings should be verified.

DEFINITION OF EFFICIENT EQUIPMENT

In order for this characterization to apply, the efficient equipment is assumed to exceed the efficiency requirements defined by the program.

DEFINITION OF BASELINE EQUIPMENT

For Time of Sale (TOS): The baseline equipment is assumed to meet the efficiency requirements within the IECC code in effect on the date of the building permit or sale (if unknown assume IECC 2021).

For New Construction (NC): The baseline equipment is assumed to meet the efficiency requirements within the IECC code in effect on the date of the building permit (if unknown assume IECC 2021). As code requirements and adoption can differ from municipality to municipality, the user should verify which version of code is applicable given these constraints.

For Early Replacement (EREP): The baseline equipment is assumed to be the existing fan.

DEEMED LIFETIME OF EFFICIENT EQUIPMENT

For variable speed fans, the expected measure life is 15 years.¹⁰⁶¹

For constant speed fans, the expected measure life is 18 years for centrifugal housed and unhoused fans. The expected measure life is 25 years for all other fan types.¹⁰⁶²

DEEMED MEASURE COST

Actual measure costs should be used if available. Default measure costs are noted below for fans with FEI greater than 1.0¹⁰⁶³. These costs are established at an FEI of 1.2. To calculate the cost for a fan with different FEI, prorate the default cost with the actual FEI (see example).

¹⁰⁶¹ "NEEP Incremental Cost Study – Phase II Final Report, Navigant, 2013."

¹⁰⁶² U.S. Department of Energy Fans and Blowers Working Group, Energy Conservation Program: Final Determination of Fans and Blowers as Covered Equipment

¹⁰⁶³ Costs are based on the U.S. Department of Energy Fans and Blowers Working Group spreadsheet: EERE-2013-BT-STD-0006-0189_attachment_1.xlsx.

TOS and NC

Fan Type	Cost (\$/hp)	
	Small (< 10 hp)	Large (>= 10 hp)
Axial Cylindrical Housed	\$264	\$87
Panel	\$29	\$10
Centrifugal Housed	\$199	\$55
Centrifugal Unhoused	\$76	\$18
Inline and Mixed Flow	\$297	\$97
Radial	\$119	\$33
Power Roof Ventilator	\$140	\$42

EREP

Fan Type	Cost (\$/hp)	
	Small (< 10 hp)	Large (>= 10 hp)
Axial Cylindrical Housed	\$3,218	\$1,068
Panel	\$319	\$104
Centrifugal Housed	\$1,381	\$382
Centrifugal Unhoused	\$827	\$195
Inline and Mixed Flow	\$2,301	\$751
Radial	\$1,570	\$434
Power Roof Ventilator	\$1,536	\$460

LOADSHAPE

For example, the default deemed measure cost of installing a new construction, centrifugal housed, 5 hp fan with FEI = 1.3 is:

Deemed Measure Costs (\$) = \$199 per hp * 5 hp * (1.3 / 1.2) = \$1,078

- Loadshape C39 – VFD – Supply fans <10 HP
- Loadshape C40 – VFD – Return fans <10 HP
- Loadshape C41 – VFD – Exhaust fans <10 HP

COINCIDENCE FACTOR

The demand savings factor (DSF) is already based upon coincident savings, and thus there is no additional coincidence factor for this characterization.

Algorithm

CALCULATION OF ENERGY SAVINGS

ELECTRIC ENERGY SAVINGS

Note this measure should be used for evaluating more efficient over baseline fans with the same control system. Measure 4.4.26 Variable Speed Drives for HVAC Supply and Return Fans should be utilized to evaluate control system modifications. When combining the two measures, the FEP_{New} value should be used to replace the $(0.746 \times HP \times \frac{LF}{\eta_{motor}})$ term in Measure 4.4.26.

$$\Delta kWh_{fan} = FEP_{New} * \left(\frac{FEI_{New}}{FEI_{Base}} - 1 \right) * RHRS * \sum_{0\%}^{100\%} (\%FF * PLR)$$

$$\Delta kWh_{total} = \Delta kWh_{fan} * (1 + IE_{energy})$$

Where:

- ΔkWh_{fan} = Fan-only annual energy savings (kWh)
- FEP_{New} = Fan Electrical Power of new fan at 100% flow fraction (kW)
- FEI_{New} = Fan Energy Index of new fan at 100% flow fraction (-)
- FEI_{Base} = Fan Energy Index of baseline fan at 100% flow fraction (-)

TOS and NC: FEI_{base} is defined per IECC.
 = 0.95 for Variable Speed Fan
 = 1.0 for Constant Speed Fan

EREP: FEI_{base} is defined as existing fan efficiency. If unknown, use:¹⁰⁶⁴

Fan Type	Drive Type		
	Variable Speed – Belt	Constant Speed – Belt	Constant Speed – Direct
Axial Cylindrical Housed	0.88	0.88	0.97
Panel	0.95	0.95	0.88
Centrifugal Housed	0.92	0.92	0.92
Centrifugal Unhoused	0.94	0.94	1.03
Inline and Mixed Flow	0.79	0.79	0.77
Radial	0.81	0.81	0.94
Power Roof Ventilator	0.82	0.82	0.76

RHRS = Annual operating hours for fan based on building type

Default hours are provided for HVAC applications which vary by HVAC application and building type.¹⁰⁶⁵ When available (provided via Energy Management Software or metered), actual hours should be used.

Building Type	Total Fan Run Hours	Model Source
Assembly	7235	eQuest
Assisted Living	8760	eQuest
Auto Dealership	7451	OpenStudio
College	4836	OpenStudio
Convenience Store	7004	eQuest
Drug Store	7156	OpenStudio
Elementary School	3765	OpenStudio

¹⁰⁶⁴ “Fan Energy Index Market Research: Final Report”, prepared for ComEd by Slipstream, May 2021.

¹⁰⁶⁵ Hours per year are estimated using the eQuest or OpenStudio models as the total number of hours the fans are operating for heating, cooling and ventilation for each building type.

Building Type	Total Fan Run Hours	Model Source
Emergency Services	8760	OpenStudio
Garage	7357	eQuest
Grocery	8543	OpenStudio
Healthcare Clinic	4314	OpenStudio
High School	3460	OpenStudio
Hospital – VAV econ	4666	OpenStudio
Hospital – CAV econ	8021	OpenStudio
Hospital – CAV no econ	7924	OpenStudio
Hospital – FCU	4055	OpenStudio
Manufacturing Facility	8706	eQuest
MF – High Rise	8760	OpenStudio
MF – Mid Rise	8760	OpenStudio
Hotel/Motel – Guest	2409	OpenStudio
Hotel/Motel – Common	8683	OpenStudio
Movie Theater	7505	eQuest
Office – High Rise – VAV econ	2369	OpenStudio
Office – High Rise – CAV econ	2279	OpenStudio
Office – High Rise – CAV no econ	5303	OpenStudio
Office – High Rise – FCU	1648	OpenStudio
Office – Low Rise	6345	OpenStudio
Office – Mid Rise	3440	OpenStudio
Religious Building	7380	eQuest
Restaurant	7302	OpenStudio
Retail – Department Store	7155	OpenStudio
Retail – Strip Mall	6921	OpenStudio
Warehouse	6832	OpenStudio
Unknown	6241	n/a

%FF = Percentage of run-time spent within a given flow fraction range¹⁰⁶⁶

Flow Fraction (% of design cfm)	Percent of Time at Flow Fraction
0% to 10%	0.0%
10% to 20%	1.0%
20% to 30%	5.5%
30% to 40%	15.5%
40% to 50%	22.0%
50% to 60%	25.0%
60% to 70%	19.0%
70% to 80%	8.5%
80% to 90%	3.0%
90% to 100%	0.5%

¹⁰⁶⁶ Default Fan Duty Cycle Based on 2012 ASHRAE Handbook; HVAC Systems and Equipment (pg. 45.11, Figure 12)

PLR = Part load ratio for a given flow fraction range¹⁰⁶⁷

Control Type	Flow Fraction									
	10%	20%	30%	40%	50%	60%	70%	80%	90%	100%
No Control or Bypass Damper	1.00	1.00	1.00	1.00	1.00	1.00	1.00	1.00	1.00	1.00
Discharge Dampers	0.46	0.55	0.63	0.70	0.77	0.83	0.88	0.93	0.97	1.00
Outlet Damper, BI & Airfoil Fans	0.53	0.53	0.57	0.64	0.72	0.80	0.89	0.96	1.02	1.05
Inlet Damper Box	0.56	0.60	0.62	0.64	0.66	0.69	0.74	0.81	0.92	1.07
Inlet Guide Vane, BI & Airfoil Fans	0.53	0.56	0.57	0.59	0.60	0.62	0.67	0.74	0.85	1.00
Inlet Vane Dampers	0.38	0.40	0.42	0.44	0.48	0.53	0.60	0.70	0.83	0.99
Outlet Damper, FC Fans	0.22	0.26	0.30	0.37	0.45	0.54	0.65	0.77	0.91	1.06
Eddy Current Drives	0.17	0.20	0.25	0.32	0.41	0.51	0.63	0.76	0.90	1.04
Inlet Guide Vane, FC Fans	0.21	0.22	0.23	0.26	0.31	0.39	0.49	0.63	0.81	1.04
VFD with duct static pressure controls	0.09	0.10	0.11	0.15	0.20	0.29	0.41	0.57	0.76	1.01
VFD with low/no duct static pressure	0.05	0.06	0.09	0.12	0.18	0.27	0.39	0.55	0.75	1.00

Provided below are the resultant values based upon the defaults provided above:

Control Type	$\sum_{0\%}^{100\%} (\%FF \times PLR)$
No Control or Bypass Damper	1.00
Discharge Dampers	0.80
Outlet Damper, BI & Airfoil Fans	0.78
Inlet Damper Box	0.69
Inlet Guide Vane, BI & Airfoil Fans	0.63
Inlet Vane Dampers	0.53
Outlet Damper, FC Fans	0.53
Eddy Current Drives	0.49
Inlet Guide Vane, FC Fans	0.39
VFD with duct static pressure controls	0.30
VFD with low/no duct static pressure	0.27

ΔkWh_{total} = Total project annual energy savings (kWh)

IE_{energy} = HVAC interactive effects factor for energy (default = 15.7%)

SUMMER COINCIDENT PEAK DEMAND SAVINGS

$$\Delta kW_{fan} = FEP_{New} * \left(\frac{FEI_{New}}{FEI_{Base}} - 1 \right) * PLR_{FFpeak}$$

$$\Delta kW_{total} = \Delta kW_{fan} * (1 + IE_{demand})$$

Where:

¹⁰⁶⁷ Methodology developed and tested in Del Balso, Ryan Joseph. "Investigation into the Reliability of Energy Efficiency/Demand Side Management Savings Estimates for Variable Frequency Drives in Commercial Applications". A project report submitted to the Faculty of the Graduate School of the University of Colorado, 2013.

ΔkW_{fan}	= Fan-only summer coincident peak demand impact (kW)
PLR_{Ffpeak}	= The part load ratio for the average flow fraction between the peak daytime hours during the weekday peak time period based on the baseline flow control type (default average flow fraction during peak period = 90%)
ΔkW_{total}	= Total project summer coincident peak demand impact (kW)
IE_{demand}	= HVAC interactive effects factor summer coincident peak demand (default = 15.7%)

FOSSIL FUEL SAVINGS

There are no expected fossil fuel impacts for this measure.

WATER AND OTHER NON-ENERGY IMPACT DESCRIPTIONS AND CALCULATION

N/A

DEEMED O&M COST ADJUSTMENT CALCULATION

N/A

MEASURE CODE: CI-HVC-FFEI-V04-250101

REVIEW DEADLINE: 1/1/2028

4.4.54 Process Heating Boiler

DESCRIPTION

A process boiler is a pressure vessel that transfers heat to water for industrial process applications. Process boilers can be configured as an integrated packaged boiler or as modular instantaneous boiler arrays. This measure is applicable to boilers which serve process loads in a facility.

Modular instantaneous boilers are a recent addition to the industrial/commercial market aimed at addressing some of the drawbacks of conventional large boiler systems. They achieve high efficiencies by using multiple smaller sized modules to meet the minimum demand. They allow each boiler to operate at or close to full rated load most of the time, with reduced standby losses. The boiler design is a low water mass pressure vessel that produces steam at operating pressure rapidly then shuts off the combustion system once the demand requirement is met, thereby saving fuel.

Traditional packaged boiler systems are designed to provide the entire steam load of the facility using one or two boilers. Typically, the boiler horsepower is sized for the maximum steam load required at any facility. However, the average steam load of any facility is only 30 to 40 percent of this, and the average load on the boiler system is low. Therefore, they are not able to achieve these high efficiencies.¹⁰⁶⁸

This measure was developed to be applicable to the following program types: NC, EREP, TOS.

DEFINITION OF EFFICIENT EQUIPMENT

The efficient case is the replacement of a non-residential standard efficiency process boiler for process loads with a high-efficiency process boiler exceeding the energy conservation standards outlined below. The efficient unit may either be a conventional packaged boiler or a modular boiler array system. Non-residential commercial boilers are defined as having an input rating greater than 300,000 Btu/h.

DEFINITION OF BASELINE EQUIPMENT

For Time of Sale and New Construction:

Gas-fired boilers, termed as commercial packaged boilers, manufactured after March 12, 2012 must comply with the standards defined in the Code of Federal Regulations, 10 CFR 431.87.¹⁰⁶⁹

Note, for natural draft steam boilers, as IECC 2021, Illinois state energy code, expected to become effective statewide in 2024, exceeds the minimum federal efficiency standards, it was replaced in favor of the more aggressive thermal efficiency values in the table below. For new construction applications where the permitting date is prior to the state’s adoption of IECC 2021 it is recommended to use the applicable edition of IECC corresponding to that timeline. As code requirements and adoption can differ from municipality to municipality, the user should verify which version of code is applicable given these constraints.

Boiler baseline efficiency standards

Boiler Type	Efficiency ¹⁰⁷⁰
Hot Water Boiler $\geq 300,000$ Btu/h and $\leq 2,500,000$ Btu/h	80% E _T
Hot Water Boiler $> 2,500,000$ Btu/h and $\leq 10,000,000$ Btu/h	82% E _C
Hot Water Boiler $> 10,000,000$ Btu/h	82% E _C
Steam Boiler $\geq 300,000$ Btu/h and $\leq 2,500,000$ Btu/h	79% E _T

¹⁰⁶⁸ Modular boiler arrays have greater combustion efficiencies as compared to traditional steam boilers. This has been verified via a field study done by Nicor Gas ETP. The study covered an industrial manufacturing facility with (10) modular process steam boiler systems; the effective efficiency was found to be in line with the rated manufacturer efficiency of 87%.

¹⁰⁶⁹ Boilers $\geq 300,000$ Btu/hr, Code of Federal Regulations, 10 CFR 431.87, Table 1 – Commercial Packaged Boiler Energy Conservation Standards.

¹⁰⁷⁰ Ibid.

Boiler Type	Efficiency ¹⁰⁷⁰
Steam Boiler $\geq 2,500,000$ Btu/h and $\leq 10,000,000$ Btu/h	79% E _T
Steam Boiler $> 10,000,000$ Btu/h	79% E _T

where E_T means “thermal efficiency” and E_c means “combustion efficiency” as defined in 10 CFR 431.82.

For early replacement: The efficiency of the existing equipment should be used for the assumed remaining useful life of the equipment and a new baseline equipment as described above for the remainder of the measure life.

DEEMED LIFETIME OF EFFICIENT EQUIPMENT

The expected measure life is assumed to be 25 years.¹⁰⁷¹

For EREP, the remaining useful life of the existing equipment is assumed to be 1/3rd of EUL (25/3) or 8 years.

DEEMED MEASURE COST

The measure cost for this technology is tiered based on the boiler type and combustion efficiencies. As installation costs for the base case and the measure case units are assumed to be the same, labor costs are not specified for this measure.

Incremental and Gross Measure costs for Process Boilers

Boiler Type	Incremental Measure Cost (\$/Kbtu) ¹⁰⁷²	Full Measure Cost (\$/Kbtu) ¹⁰⁷³
Hot Water Boiler $\geq 85\%$ E _c and $< 90\%$ E _c	\$2.17	\$12.94
Hot Water Boiler $\geq 90\%$ E _c	\$12.17	\$22.95
Steam Boiler $\geq 83\%$ E _c and $< 85\%$ E _c	\$4.35	\$19.24
Modular Steam Boiler Arrays ($\geq 85\%$ E _c) ¹⁰⁷⁴	Custom	

A deferred baseline replacement cost, consistent with the delta between the full measure cost and incremental cost above should be assumed after the remaining useful life of the existing equipment.

LOADSHAPE

N/A

COINCIDENCE FACTOR

N/A

Algorithm

¹⁰⁷¹ <https://www.govinfo.gov/content/pkg/FR-2020-01-10/pdf/2019-26356.pdf>.

¹⁰⁷² California ETRM measure “Process Boiler”, <https://www.caetrm.com/measure/SWWH008/01/>, accessed April 16, 2021..

¹⁰⁷³ Ibid.

¹⁰⁷⁴ Miura Modular Boilers, <https://s29958.pcdn.co/wp-content/uploads/2019/03/LXBrochure2016.pdf>

CALCULATION OF ENERGY SAVINGS

ELECTRIC ENERGY SAVINGS

N/A

SUMMER COINCIDENT PEAK DEMAND SAVINGS

N/A

FOSSIL FUEL SAVINGS

For first 8 years:

$$\Delta Therms = 8,766 * Capacity * UF * \left(\frac{Efficiency_{EE}}{Efficiency_{Exist}} - 1 \right) * \frac{1}{100,000}$$

For remaining 17 years:

$$\Delta Therms = 8,766 * Capacity * UF * \left(\frac{Efficiency_{EE}}{Efficiency_{Base}} - 1 \right) * \frac{1}{100,000}$$

Where:

- 8,766 = Annual Operating hours for Process Boilers
The assumed hours of operation are based on continual plant operation. Variation in plant operating hours is accounted for in the utilization factor. While the boiler may operate during the entire year, it may not be operating at its full rated load.
- Capacity = Nominal heating input capacity boiler size for high-efficiency unit (Btu/hr)
- UF = Utilization Factor
= Custom or if unknown 41.9%¹⁰⁷⁵
- Efficiency_{Exist} = Existing boiler efficiency rating,
= Actual
- Efficiency_{Base} = Baseline boiler efficiency rating, dependent on year and boiler type or use actual operating efficiencies for early replacements. See table in “Definition of Baseline Equipment.”
- Efficiency_{EE} = Efficient boiler efficiency rating for packaged or modular boiler system
= Actual value, specified to one significant digit (i.e., 95.7%)
- 100,000 = Constant to convert from Btu to therm

For example, an 800,000 Btu/hr gas-fired process steam boiler with a thermal efficiency rating of 87% is installed replacing a similar sized natural draft steam boiler with baseline efficiency of 79%.

$$\begin{aligned} \Delta Therms &= 8,766 * 800,000 * 0.419 * (0.870 - 0.790) / 0.790 / 100,000 \\ &= 2,976 \text{ therms} \end{aligned}$$

¹⁰⁷⁵ Illinois TRM v9.0, measure 4.4.3 Process Boiler Tune-up, “Work Paper – Tune up for Boilers serving Space Heating and Process Load by Resource Solutions Group, January 2012”.

WATER AND OTHER NON-ENERGY IMPACT DESCRIPTIONS AND CALCULATION

N/A

DEEMED O&M COST ADJUSTMENT CALCULATION

N/A

MEASURE CODE: CI-HVC-PHBO-V04-240101

REVIEW DEADLINE: 1/1/2027

4.4.55 Commercial Gas Heat Pump

DESCRIPTION

Heat pumps are a class of HVAC equipment that moves heat from cold source to warm sink, moving heat “uphill”. Often heat pumps can operate in reverse, using a reversing valve or other means to provide air conditioning (A/C) and space heating with the same product. If heat recovery is employed, the heat pump can also provide service hot water (SHW). Heat pumps generally involve the use of a refrigerant and utilize refrigeration cycles. Gas-fired heat pumps are a subset of heat pumps whose primary input drive energy is a gaseous fuel, instead of an electrically-driven compressor. Gas-fired heat pumps can be separated into two categories, *work-activated* technologies where a delivered fuel drives a prime mover (e.g., internal combustion engine) which supplies work to a refrigerant compressor, and *heat-activated* where the primary energy input to the heat pump cycle is thermal energy, often from fuel combustion, driving a sorption-type or other thermally-driven heat pump cycle.

This measure characterizes the installation of a commercial gas-fired heat pump for the following scenarios: NC, TS, EREP, and RF.

A. New Construction:

- i. The installation of a new commercial heat-activated (e.g., sorption-type) or work-activated (e.g., engine-driven) gas heat pump, certified to ANSI Z21.40.1 or ANSI Z21.40.2 respectively, that meets the criteria laid out in ANSI Z21.40.4 Performance Testing and Rating of Gas-Fired, Air Conditioning and Heat Pump Appliances.
- ii. Note the baseline in this case should be determined via EM&V and the algorithms are provided to allow savings to be calculated from any baseline condition defined in the Efficient Equipment section.

B. Time of Sale:

- i. The planned installation of a new gas heat pump meeting the efficiency standards laid out below that does not meet the criteria for early replacement as described in section C below.
- ii. Note the baseline in this case is the purchase of new equipment that is similar technology to existing equipment. Where unknown, the baseline should be determined via EM&V and the algorithms are provided to allow savings to be calculated from any baseline condition. The calculation of savings is dependent on whether an incentive for the installation has been provided by both a gas and electric utility, only an electric utility, or only a gas utility. SHW savings are calculated based on the fuel and efficiency of the existing unit.

C. Early Replacement/Retrofit:

- i. The early removal of functioning electric or gas space heating and/or cooling systems from service, prior to the natural end of life, and replacement with a new high efficiency commercial gas heat pump system.
- ii. Note the baseline in this case is the existing equipment being replaced. The calculation of savings is dependent on whether an incentive for the installation has been provided by both a gas and electric utility, only an electric utility, or only a gas utility. SHW savings are calculated based on the fuel and efficiency of the existing unit.
- iii. Early Replacement determination will be based on meeting the following conditions:
 - a. The existing unit is operational when replaced, or
 - b. The existing unit requires minor repairs to be operational, defined as costing less than 20% of the new baseline replacement cost (as defined in the Measured Cost section of the relevant equipment).
 - c. All other conditions will be considered Time of Sale.

For the Baseline efficiency of the existing unit being replaced:

- a. Use actual existing efficiency whenever possible.
- b. If the efficiency of the existing unit is unknown, use assumptions based on the Federal minimum standards provided in tables below.

- c. If the operational status or repair cost of the existing unit is unknown use time of sale assumptions.

DEFINITION OF EFFICIENT EQUIPMENT

Gaseous fuel heat pumps for space heating/cooling and domestic/service hot water heating. The table below shows the current gas heat pump products in two broad commercial categories – water heating and space heating/cooling. The table additionally lists applicable industry test methods and the primary efficiency metric.

Table 1: Current Gas Heat Pump Products

Equipment			Test Method	Efficiency Metric	
Category	Sector	Type	Industry	Primary Metric	Tested Performance
Water Heating	Commercial	Gas HPWH with or without storage tank	ANSI/ASHRAE 118.1	Coefficient of Performance (COP)	> 1.2 COP
Space Heating & Cooling	Commercial	Gas-fired air-conditioner or heat pump	ANSI Z21.40.4	Coefficient of Performance (COP) for heating / cooling	> 1.2 COP _{heating} or > 1.0 COP _{cooling}

DEFINITION OF BASELINE EQUIPMENT

The baseline equipment includes Service Hot Water, Space Heating, and Air-Conditioning.

New Construction:

The 2018 edition of the IECC (effective July 1, 2019 to 12/31/2023) and IECC 2021 (effective statewide as of 1/1/2024) for commercial facilities and is applicable here.

To calculate savings with an electric baseline, the baseline equipment is assumed to be an Air Source Heat Pump meeting the state energy code efficiency level as outlined in **Error! Reference source not found.** (IECC 2018, effective July 1, 2019 to IECC 2021 effective date) and Table 7 (IECC 2021, expected to become effective statewide in 2023) below.

To calculate savings with a chiller/unitary cooling system (**Error! Reference source not found.**, IECC 2018 and Table 8, IECC 2021) and boiler/furnace baseline (**Error! Reference source not found.** and Table 9 for boilers and **Error! Reference source not found.** and Table 10 for warm air furnaces), the baseline equipment is assumed to meet the minimum standard efficiencies as outlined in their respective tables.

To calculate savings with water heater applications, the baseline equipment is assumed to meet the minimum standard efficiencies outlined in **Error! Reference source not found.** (IECC 2018) or Table 11 (IECC 2021).

As code requirements and adoption can differ from municipality to municipality, the user should verify which version of code is applicable given these constraints. If evaluation determines the applicable version of code, given location and timing, isn't an appropriate baseline due to supply constraints, low compliance, or other issues, the previous iteration of code may be used through 2023.

Table 2: IECC 2018 Air-Source Heat Pumps Minimum Efficiency Requirements

TABLE C403.3.2(2)
MINIMUM EFFICIENCY REQUIREMENTS: ELECTRICALLY OPERATED UNITARY AND APPLIED HEAT PUMPS

EQUIPMENT TYPE	SIZE CATEGORY	HEATING SECTION TYPE	SUBCATEGORY OR RATING CONDITION	MINIMUM EFFICIENCY	TEST PROCEDURE ^a
Air cooled (cooling mode)	< 65,000 Btu/h ^b	All	Split System	14.0 SEER	AHRI 210/240
			Single Package	14.0 SEER	
Through-the-wall, air cooled	≤ 30,000 Btu/h ^b	All	Split System	12.0 SEER	
			Single Package	12.0 SEER	
Single-duct high-velocity air cooled	< 65,000 Btu/h ^b	All	Split System	11.0 SEER	
Air cooled (cooling mode)	≥ 65,000 Btu/h and < 135,000 Btu/h	Electric Resistance (or None)	Split System and Single Package	11.0 EER 12.0 IEER	
		All other	Split System and Single Package	10.8 EER 11.8 IEER	
	≥ 135,000 Btu/h and < 240,000 Btu/h	Electric Resistance (or None)	Split System and Single Package	10.6 EER 11.6 IEER	
		All other	Split System and Single Package	10.4 EER 11.4 IEER	
	≥ 240,000 Btu/h	Electric Resistance (or None)	Split System and Single Package	9.5 EER 10.6 IEER	
		All other	Split System and Single Package	9.3 EER 9.4 IEER	
Water to Air: Water Loop (cooling mode)	< 17,000 Btu/h	All	86°F entering water	12.2 EER	ISO 13256-1
	≥ 17,000 Btu/h and < 65,000 Btu/h	All	86°F entering water	13.0 EER	
	≥ 65,000 Btu/h and < 135,000 Btu/h	All	86°F entering water	13.0 EER	
Water to Air: Ground Water (cooling mode)	< 135,000 Btu/h	All	59°F entering water	18.0 EER	ISO 13256-1
Brine to Air: Ground Loop (cooling mode)	< 135,000 Btu/h	All	77°F entering water	14.1 EER	ISO 13256-1
Water to Water: Water Loop (cooling mode)	< 135,000 Btu/h	All	86°F entering water	10.6 EER	ISO 13256-2
Water to Water: Ground Water (cooling mode)	< 135,000 Btu/h	All	59°F entering water	16.3 EER	
Brine to Water: Ground Loop (cooling mode)	< 135,000 Btu/h	All	77°F entering fluid	12.1 EER	

(Table 2 Continued)

Air cooled (heating mode)	< 65,000 Btu/h ^b	—	Split System	8.2 HSPF	AHRI 210/240
		—	Single Package	8.0 HSPF	
Through-the-wall, (air cooled, heating mode)	≤ 30,000 Btu/h ^b (cooling capacity)	—	Split System	7.4 HSPF	
		—	Single Package	7.4 HSPF	
Small-duct high velocity (air cooled, heating mode)	< 65,000 Btu/h ^b	—	Split System	6.8 HSPF	
Air cooled (heating mode)	≥ 65,000 Btu/h and < 135,000 Btu/h (cooling capacity)	—	47°F db/43°F wb outdoor air	3.3 COP	
			17°Fdb/15°F wb outdoor air	2.25 COP	
	≥ 135,000 Btu/h (cooling capacity)	—	47°F db/43°F wb outdoor air	3.2 COP	
			17°Fdb/15°F wb outdoor air	2.05 COP	
Water to Air: Water Loop (heating mode)	< 135,000 Btu/h (cooling capacity)	—	68°F entering water	4.3 COP	ISO 13256-1
Water to Air: Ground Water (heating mode)	< 135,000 Btu/h (cooling capacity)	—	50°F entering water	3.7 COP	
Brine to Air: Ground Loop (heating mode)	< 135,000 Btu/h (cooling capacity)	—	32°F entering fluid	3.2 COP	
Water to Water: Water Loop (heating mode)	< 135,000 Btu/h (cooling capacity)	—	68°F entering water	3.7 COP	ISO 13256-2
Water to Water: Ground Water (heating mode)	< 135,000 Btu/h (cooling capacity)	—	50°F entering water	3.1 COP	
Brine to Water: Ground Loop (heating mode)	< 135,000 Btu/h (cooling capacity)	—	32°F entering fluid	2.5 COP	

For SI: 1 British thermal unit per hour = 0.2931 W, °C = [(°F) - 32]/1.8.

- a. Chapter 6 contains a complete specification of the referenced test procedure, including the reference year version of the test procedure.
- b. Single-phase, air-cooled heat pumps less than 65,000 Btu/h are regulated by NAECA. SEER and HSPF values are those set by NAECA.

Table 3: IECC 2018 Electric Chillers, Air-Cooled and Water-Cooled Minimum Efficiency Requirements

TABLE C403.3.2(7)
WATER CHILLING PACKAGES — EFFICIENCY REQUIREMENTS^{a, b, d}

EQUIPMENT TYPE	SIZE CATEGORY	UNITS	BEFORE 1/1/2015		AS OF 1/1/2015		TEST PROCEDURE ^c	
			Path A	Path B	Path A	Path B		
Air-cooled chillers	< 150 Tons	EER (Btu/W)	≥ 9.562 FL	NA ^c	≥ 10.100 FL	≥ 9.700 FL	AHRI 550/590	
			≥ 12.500 IPLV		≥ 13.700 IPLV	≥ 15.800 IPLV		
	≥ 150 Tons	≥ 9.562 FL	NA ^c	≥ 10.100 FL	≥ 9.700 FL			
		≥ 12.500 IPLV		≥ 14.000 IPLV	≥ 16.100 IPLV			
Air cooled without condenser, electrically operated	All capacities	EER (Btu/W)	Air-cooled chillers without condenser shall be rated with matching condensers and complying with air-cooled chiller efficiency requirements.					
Water cooled, electrically operated positive displacement	< 75 Tons	kW/ton	≤ 0.780 FL	≤ 0.800 FL	≤ 0.750 FL	≤ 0.780 FL		AHRI 550/590
			≤ 0.630 IPLV	≤ 0.600 IPLV	≤ 0.600 IPLV	≤ 0.500 IPLV		
	≥ 75 tons and < 150 tons		≤ 0.775 FL	≤ 0.790 FL	≤ 0.720 FL	≤ 0.750 FL		
			≤ 0.615 IPLV	≤ 0.586 IPLV	≤ 0.560 IPLV	≤ 0.490 IPLV		
	≥ 150 tons and < 300 tons		≥ 0.680 FL	≥ 0.718 FL	≥ 0.660 FL	≥ 0.680 FL		
			≥ 0.580 IPLV	≥ 0.540 IPLV	≥ 0.540 IPLV	≥ 0.440 IPLV		
	≥ 300 tons and < 600 tons		≤ 0.620 FL	≤ 0.639 FL	≤ 0.610 FL	≤ 0.625 FL		
			≤ 0.540 IPLV	≤ 0.490 IPLV	≤ 0.520 IPLV	≤ 0.410 IPLV		
≥ 600 tons	≤ 0.620 FL	≤ 0.639 FL	≤ 0.560 FL	≤ 0.585 FL				
≤ 0.540 IPLV	≤ 0.490 IPLV	≤ 0.500 IPLV	≤ 0.380 IPLV					
Water cooled, electrically operated centrifugal	< 150 Tons	kW/ton	≤ 0.634 FL	≤ 0.639 FL	≤ 0.610 FL	≤ 0.695 FL	AHRI 560	
			≤ 0.596 IPLV	≤ 0.450 IPLV	≤ 0.550 IPLV	≤ 0.440 IPLV		
	≥ 150 tons and < 300 tons		≤ 0.634 FL	≤ 0.639 FL	≤ 0.610 FL	≤ 0.635 FL		
			≤ 0.596 IPLV	≤ 0.450 IPLV	≤ 0.550 IPLV	≤ 0.400 IPLV		
	≥ 300 tons and < 400 tons		≤ 0.576 FL	≤ 0.600 FL	≤ 0.560 FL	≤ 0.595 FL		
			≤ 0.549 IPLV	≤ 0.400 IPLV	≤ 0.520 IPLV	≤ 0.390 IPLV		
	≥ 400 tons and < 600 tons		≤ 0.576 FL	≤ 0.600 FL	≤ 0.560 FL	≤ 0.585 FL		
			≤ 0.549 IPLV	≤ 0.400 IPLV	≤ 0.500 IPLV	≤ 0.380 IPLV		
≥ 600 Tons	≤ 0.570 FL	≤ 0.590 FL	≤ 0.560 FL	≤ 0.585 FL				
≤ 0.539 IPLV	≤ 0.400 IPLV	≤ 0.500 IPLV	≤ 0.380 IPLV					
Air cooled, absorption, single effect	All capacities	COP	≥ 0.600 FL	NA ^c	≥ 0.600 FL	NA ^c	AHRI 560	
Water cooled absorption, single effect	All capacities	COP	≥ 0.700 FL	NA ^c	≥ 0.700 FL	NA ^c		
Absorption, double effect, indirect fired	All capacities	COP	≥ 1.000 FL	NA ^c	≥ 1.000 FL	NA ^c		
			≥ 1.050 IPLV		≥ 1.050 IPLV			
Absorption double effect direct fired	All capacities	COP	≥ 1.000 FL	NA ^c	≥ 1.000 FL	NA ^c		
			≥ 1.000 IPLV		≥ 1.050 IPLV			

Note: Code of Federal Regulations for gas-fired hot water boilers (10 CFR 432I(3)):require:

<300,000 Btu/hr hot water boilers to be 84% AFUE, and

<300,000 Btu/hr steam boilers to be 82% AFUE

See **Table 4** below for all other minimum efficiencies.

Table 4: IECC 2018 Boiler Minimum Efficiency Requirements

TABLE C403.3.2(5)
MINIMUM EFFICIENCY REQUIREMENTS: GAS- AND OIL-FIRED BOILERS

EQUIPMENT TYPE ^a	SUBCATEGORY OR RATING CONDITION	SIZE CATEGORY (INPUT)	MINIMUM EFFICIENCY ^{d, e}	TEST PROCEDURE
Boilers, hot water	Gas-fired	< 300,000 Btu/h ^{f, g}	82% AFUE	10 CFR Part 430
		≥ 300,000 Btu/h and ≤ 2,500,000 Btu/h ^b	80% E _t	10 CFR Part 431
		> 2,500,000 Btu/h ^a	82% E _c	
	Oil-fired ^c	< 300,000 Btu/h ^a	84% AFUE	10 CFR Part 430
		≥ 300,000 Btu/h and ≤ 2,500,000 Btu/h ^b	82% E _t	10 CFR Part 431
		> 2,500,000 Btu/h ^a	84% E _c	
Boilers, steam	Gas-fired	< 300,000 Btu/h ^f	80% AFUE	10 CFR Part 430
	Gas-fired- all, except natural draft	≥ 300,000 Btu/h and ≤ 2,500,000 Btu/h ^b	79% E _t	10 CFR Part 431
		> 2,500,000 Btu/h ^a	79% E _t	
	Gas-fired-natural draft	≥ 300,000 Btu/h and ≤ 2,500,000 Btu/h ^b	77% E _t	
		> 2,500,000 Btu/h ^a	77% E _t	
	Oil-fired ^c	< 300,000 Btu/h	82% AFUE	10 CFR Part 430
		≥ 300,000 Btu/h and ≤ 2,500,000 Btu/h ^b	81% E _t	10 CFR Part 431
		> 2,500,000 Btu/h ^a	81% E _t	

Table 5: IECC 2018 Warm-Air Furnace Minimum Efficiency Requirements

TABLE C403.3.2(4)
WARM-AIR FURNACES AND COMBINATION WARM-AIR FURNACES/AIR-CONDITIONING UNITS, WARM-AIR DUCT FURNACES AND UNIT HEATERS, MINIMUM EFFICIENCY REQUIREMENTS

EQUIPMENT TYPE	SIZE CATEGORY (INPUT)	SUBCATEGORY OR RATING CONDITION	MINIMUM EFFICIENCY ^{d, e}	TEST PROCEDURE ^a
Warm-air furnaces, gas fired	< 225,000 Btu/h	—	80% AFUE or 80%E _t	DOE 10 CFR Part 430 or ANSI Z21.47
	≥ 225,000 Btu/h	Maximum capacity ^c	80%E _t ^f	ANSI Z21.47
Warm-air furnaces, oil fired	< 225,000 Btu/h	—	83% AFUE or 80%E _t	DOE 10 CFR Part 430 or UL 727
	≥ 225,000 Btu/h	Maximum capacity ^b	81%E _t ^g	UL 727
Warm-air duct furnaces, gas fired	All capacities	Maximum capacity ^b	80%E _c	ANSI Z83.8
Warm-air unit heaters, gas fired	All capacities	Maximum capacity ^b	80%E _c	ANSI Z83.8
Warm-air unit heaters, oil fired	All capacities	Maximum capacity ^b	80%E _c	UL 731

Table 6: IECC 2018 Water Heater Minimum Efficiency Requirements

TABLE C404.2
MINIMUM PERFORMANCE OF WATER-HEATING EQUIPMENT



EQUIPMENT TYPE	SIZE CATEGORY (input)	SUBCATEGORY OR RATING CONDITION	PERFORMANCE REQUIRED ^{a, b}	TEST PROCEDURE	
Water heaters, electric	≤ 12 kW ^d	Tabletop ^e , ≥ 20 gallons and ≤ 120 gallons	0.93 - 0.00132V, EF	DOE 10 CFR Part 430	
		Resistance ≥ 20 gallons and ≤ 55 gallons	0.960 - 0.0003V, EF		
		Grid-enabled ^f > 75 gallons and ≤ 120 gallons	1.061 - 0.00168V, EF		
	> 12 kW	Resistance	(0.3 + 27/V _m), %/h	ANSI Z21.10.3	
	≤ 24 amps and ≤ 250 volts	Heat pump > 55 gallons and ≤ 120 gallons	2.057 - 0.00113V, EF	DOE 10 CFR Part 430	
Storage water heaters, gas	≤ 75,000 Btu/h	≥ 20 gallons and > 55 gallons	0.675 - 0.0015V, EF	DOE 10 CFR Part 430	
		> 55 gallons and ≤ 100 gallons	0.8012 - 0.00078V, EF		
	> 75,000 Btu/h and ≤ 155,000 Btu/h	< 4,000 Btu/h/gal		80% E _t	ANSI Z21.10.3
		< 4,000 Btu/h/gal			
Instantaneous water heaters, gas	> 50,000 Btu/h and < 200,000 Btu/h ^c	≥ 4,000 (Btu/h)/gal and < 2 gal	0.82 - 0.00 19V, EF	DOE 10 CFR Part 430	
	≥ 200,000 Btu/h	≥ 4,000 Btu/h/gal and < 10 gal	80% E _t	ANSI Z21.10.3	
	≥ 200,000 Btu/h	≥ 4,000 Btu/h/gal and ≥ 10 gal	80% E _t 		

Table 7: IECC 2021 Air-Source Heat Pumps Minimum Efficiency Requirements

TABLE C403.3.2(2)
ELECTRICALLY OPERATED AIR-COOLED UNITARY HEAT PUMPS—MINIMUM EFFICIENCY REQUIREMENTS^{a, d}

EQUIPMENT TYPE	SIZE CATEGORY	HEADING SECTION TYPE	SUBCATEGORY OR RATING CONDITION	MINIMUM EFFICIENCY	TEST PROCEDURE ^e
Air cooled (cooling mode)	< 66,000 Btu/h	All	Split system, three phase and applications outside US single phase ^b	14.0 SEER before 1/1/2023 14.3 SEER2 after 1/1/2023	AHRI 210/240—2017 before 1/1/2023 AHRI 210/240—2023 after 1/1/2023
			Single package, three phase and applications outside US single phase ^b	14.0 SEER before 1/1/2023 13.4 SEER2 after 1/1/2023	
Space constrained, air cooled (cooling mode)	≤ 30,000 Btu/h	All	Split system, three phase and applications outside US single phase ^b	12.0 SEER before 1/1/2023 11.7 SEER2 after 1/1/2023	AHRI 210/240—2017 before 1/1/2023 AHRI 210/240—2023 after 1/1/2023
			Single package, three phase and applications outside US single phase ^b	12.0 SEER before 1/1/2023 11.7 SEER2 after 1/1/2023	
Single duct, high velocity, air cooled (cooling mode)	< 65,000	All	Split system, three phase and applications outside US single phase ^b	12.0 SEER before 1/1/2023 12.0 SEER2 after 1/1/2023	AHRI 210/240—2017 before 1/1/2023 AHRI 210/240—2023 after 1/1/2023
Air cooled (cooling mode)	≥ 65,000 Btu/h and < 135,000 Btu/h	Electric resistance (or none)	Split system and single package	11.0 EER 12.2 IEER before 1/1/2023 14.1 IEER after 1/1/2023	AHRI 340/360
		All other		10.8 EER 12.0 IEER before 1/1/2023 13.9 IEER after 1/1/2023	
	≥ 135,000 Btu/h and < 240,000 Btu/h	Electric resistance (or none)		10.6 EER 11.6 IEER before 1/1/2023 13.5 IEER after 1/1/2023	
		All other		10.4 EER 11.4 IEER before 1/1/2023 13.3 IEER after 1/1/2023	
	≥ 240,000 Btu/h	Electric resistance (or none)		9.5 EER 10.6 IEER before 1/1/2023 12.5 IEER after 1/1/2023	
		All other		9.3 EER 10.4 IEER before 1/1/2023 12.3 IEER after 1/1/2023	
Air cooled (heating mode)	< 65,000 Btu/h	All	Split system, three phase and applications outside US single phase ^b	8.2 HSPF before 1/1/2023 7.5 HSPF2 after 1/1/2023	AHRI 210/240—2017 before 1/1/2023 AHRI 210/240—2023 after 1/1/2023
			Single package, three phase and applications outside US single phase ^b	8.0 HSPF before 1/1/2023 6.7 HSPF2 after 1/1/2023	

(Table 7 Continued)

TABLE C403.3.2(2)—continued
ELECTRICALLY OPERATED AIR-COOLED UNITARY HEAT PUMPS—MINIMUM EFFICIENCY REQUIREMENTS^{a, d}

EQUIPMENT TYPE	SIZE CATEGORY	HEADING SECTION TYPE	SUBCATEGORY OR RATING CONDITION	MINIMUM EFFICIENCY	TEST PROCEDURE ^a
Space constrained, air cooled (heating mode)	≤ 30,000 Btu/h	All	Split system, three phase and applications outside US single phase ^b	7.4 HSPF before 1/1/2023 6.3 HSPF2 after 1/1/2023	AHRI 210/240—2017 before 1/1/2023 AHRI 210/240—2023 after 1/1/2023
			Single package, three phase and applications outside US single phase ^b	7.4 HSPF before 1/1/2023 6.3 HSPF2 after 1/1/2023	
Small duct, high velocity, air cooled (heating mode)	< 65,000 Btu/h	All	Split system, three phase and applications outside US single phase ^b	7.2 HSPF before 1/1/2023 6.1 HSPF2 after 1/1/2023	AHRI 210/240—2017 before 1/1/2023 AHRI 210/240—2023 after 1/1/2023
Air cooled (heating mode)	≥ 65,000 Btu/h and < 135,000 Btu/h (cooling capacity)	All	47°F db/43°F wb outdoor air	3.30 COP _H before 1/1/2023 3.40 COP _H after 1/1/2023	AHRI 340/360
			17°F db/15°F wb outdoor air	2.25 COP _H	
	≥ 135,000 Btu/h and < 240,000 Btu/h (cooling capacity)		47°F db/43°F wb outdoor air	3.20 COP _H before 1/1/2023 3.30 SOP _H after 1/1/2023	
			17°F db/15°F wb outdoor air	2.05 COP _H	
	≥ 240,000 Btu/h (cooling capacity)		47°F db/43°F wb outdoor air	3.20 COP _H	
			17°F db/15°F wb outdoor air	2.05 COP _H	

Table 8: IECC 2021 Electric Chillers, Air-Cooled and Water-Cooled Minimum Efficiency Requirements

TABLE C403.3.2(3)
WATER-CHILLING PACKAGES—MINIMUM EFFICIENCY REQUIREMENTS^{a, b, e, f}

EQUIPMENT TYPE	SIZE CATEGORY	UNITS	PATH A	PATH B	TEST PROCEDURE ^e
Air cooled chillers	< 150 tons	EER (Btu/Wh)	≥ 10.100 FL	≥ 9.700 FL	AHRI 550/590
			≥ 13.700 IPLV.IP	≥ 15.800 IPLV.IP	
	≥ 150 tons		≥ 10.100 FL	≥ 9.700FL	
			≥ 14.000 IPLV.IP	≥ 16.100 IPLV.IP	
Air cooled without condenser, electrically operated	All capacities	EER (Btu/Wh)	Air-cooled chillers without condenser must be rated with matching condensers and comply with air-cooled chiller efficiency requirements		AHRI 550/590
Water cooled, electrically operated positive displacement	< 75 tons	kW/ton	≤ 0.750 FL	≤ 0.780 FL	AHRI 550/590
	≥ 75 tons and < 150 tons		≤ 0.600 IPLV.IP	≤ 0.500 IPLV.IP	
			≤ 0.720 FL	≤ 0.750 FL	
	≥ 150 tons and < 300 tons		≤ 0.560 IPLV.IP	≤ 0.490 IPLV.IP	
			≤ 0.660 FL	≤ 0.680 FL	
	≥ 300 tons and < 600 tons		≤ 0.540 IPLV.IP	≤ 0.440 IPLV.IP	
			≤ 0.610 FL	≤ 0.625 FL	
	≥ 600 tons		≤ 0.520 IPLV.IP	≤ 0.410 IPLV.IP	
≤ 0.560 FL		≤ 0.585 FL			
Water cooled, electrically operated centrifugal	< 150 tons	kW/ton	≤ 0.610 FL	≤ 0.695 FL	AHRI 550/590
			≤ 0.550 IPLV.IP	≤ 0.440 IPLV.IP	
			≤ 0.610 FL	≤ 0.635 FL	
	≥ 300 tons and < 400 tons		≤ 0.550 IPLV.IP	≤ 0.400 IPLV.IP	
			≤ 0.560 FL	≤ 0.595 FL	
	≥ 400 tons and < 600 tons		≤ 0.520 IPLV.IP	≤ 0.390 IPLV.IP	
			≤ 0.560 FL	≤ 0.585 FL	
	≥ 600 tons		≤ 0.500 IPLV.IP	≤ 0.380 IPLV.IP	
			≤ 0.560 FL	≤ 0.585 FL	
	≤ 0.500 IPLV.IP		≤ 0.380 IPLV.IP		
Air cooled absorption, single effect	All capacities	COP (W/W)	≥ 0.600 FL	NA ^d	AHRI 560
Water cooled absorption, single effect	All capacities	COP (W/W)	≥ 0.700 FL	NA ^d	AHRI 560
Absorption double effect, indirect fired	All capacities	COP (W/W)	≥ 1.000 FL	NA ^d	AHRI 560
			≥ 0.150 IPLV.IP		
Absorption double effect, direct fired	All capacities	COP (W/W)	≥ 1.000 FL	NA ^d	AHRI 560
			≥ 1.000 IPLV		

- a. Chapter 6 contains a complete specification of the referenced standards, which include test procedures, including the reference year version of the test procedure.
- b. The requirements for centrifugal chillers shall be adjusted for nonstandard rating conditions per Section C403.3.2.1 and are applicable only for the range of conditions listed there. The requirements for air-cooled, water-cooled positive displacement and absorption chillers are at standard rating conditions defined in the reference test procedure.
- c. Both the full-load and IPLV.IP requirements must be met or exceeded to comply with this standard. When there is a Path B, compliance can be with either Path A or Path B for any application.
- d. NA means the requirements are not applicable for Path B, and only Path A can be used for compliance.
- e. FL is the full-load performance requirements, and IPLV.IP is for the part-load performance requirements.
- f. This table is a replica of ASHRAE 90.1 Table 6.8.1-3 Water-Chilling Packages—Minimum Efficiency Requirements.

Note: Code of Federal Regulations for gas-fired hot water boilers (10 CFR 432I(3)) requires:

<300,000 Btu/hr hot water boilers to be 84% AFUE, and

<300,000 Btu/hr steam boilers to be 82% AFUE

See Table 9 below for all other minimum efficiencies.

Table 9: IECC 2021 Boiler Minimum Efficiency Requirements

TABLE C403.3.2(6)
GAS- AND OIL-FIRED BOILERS—MINIMUM EFFICIENCY REQUIREMENTS¹

EQUIPMENT TYPE ^a	SUBCATEGORY OR RATING CONDITION	SIZE CATEGORY (INPUT)	MINIMUM EFFICIENCY	EFFICIENCY AS OF 3/2/2022	TEST PROCEDURE ^a
Boilers, hot water	Gas fired	< 300,000 Btu/h ^{e, b} for applications outside US	82% AFUE	82% AFUE	DOE 10 CFR 430 Appendix N
		≥ 300,000 Btu/h and ≤ 2,500,000 Btu/h ^a	80% E_t^d	80% E_t^d	DOE 10 CFR 431.86
		> 2,500,000 Btu/h ^b	82% E_c^c	82% E_c^c	
	Oil fired ^f	< 300,000 Btu/h ^{e, b} for applications outside US	84% AFUE	84% AFUE	DOE 10 CFR 430 Appendix N
		≥ 300,000 Btu/h and ≤ 2,500,000 Btu/h ^a	82% E_t^d	82% E_t^d	DOE 10 CFR 431.86
		> 2,500,000 Btu/h ^b	84% E_c^c	84% E_c^c	
Boilers, steam	Gas fired	< 300,000 Btu/h ^e for applications outside US	80% AFUE	80% AFUE	DOE 10 CFR 430 Appendix N
	Gas fired—all, except natural draft	≥ 300,000 Btu/h and ≤ 2,500,000 Btu/h ^a	79% E_t^d	79% E_t^d	DOE 10 CFR 431.86
		> 2,500,000 Btu/h ^b	79% E_t^d	79% E_t^d	
	Gas fired—natural draft	≥ 300,000 Btu/h and ≤ 2,500,000 Btu/h ^a	77% E_t^d	79% E_t^d	
		> 2,500,000 Btu/h ^b	77% E_t^d	79% E_t^d	
	Oil fired ^f	< 300,000 Btu/h ^e for applications outside US	82% AFUE	82% AFUE	DOE 10 CFR 430 Appendix N
		≥ 300,000 Btu/h and ≤ 2,500,000 Btu/h ^a	81% E_t^d	81% E_t^d	DOE 10 CFR 431.86
		> 2,500,000 Btu/h ^b	81% E_t^d	81% E_t^d	

Table 10: IECC 2021 Warm-Air Furnace Minimum Efficiency Requirements

TABLE C403.3.2(5)
 WARM-AIR FURNACES AND COMBINATION WARM-AIR FURNACES/AIR-CONDITIONING UNITS,
 WARM-AIR DUCT FURNACES AND UNIT HEATERS—MINIMUM EFFICIENCY REQUIREMENTS^a

EQUIPMENT TYPE	SIZE CATEGORY (INPUT)	SUBCATEGORY OR RATING CONDITION	MINIMUM EFFICIENCY	TEST PROCEDURE ^a
Warm-air furnace, gas fired for application outside the US	< 225,000 Btu/h	Maximum capacity ^c	80% AFUE (nonweatherized) or 81% AFUE (weatherized) or 80% $E_t^{b,d}$	DOE 10 CFR 430 Appendix N or Section 2.39, Thermal Efficiency, ANSI Z21.47
Warm-air furnace, gas fired	< 225,000 Btu/h	Maximum capacity ^c	80% $E_t^{b,d}$ before 1/1/2023 81% E_t^d after 1/1/2023	Section 2.39, Thermal Efficiency, ANSI Z21.47
Warm-air furnace, oil fired for application outside the US	< 225,000 Btu/h	Maximum capacity ^c	83% AFUE (nonweatherized) or 78% AFUE (weatherized) or 80% $E_t^{b,d}$	DOE 10 CFR 430 Appendix N or Section 42, Combustion, UL 727
Warm-air furnace, oil fired	< 225,000 Btu/h	Maximum capacity ^c	80% E_t before 1/1/2023 82% E_t^d after 1/1/2023	Section 42, Combustion, UL 727
Electric furnaces for applications outside the US	< 225,000 Btu/h	All	96% AFUE	DOE 10 CFR 430 Appendix N
Warm-air duct furnaces, gas fired	All capacities	Maximum capacity ^c	80% E_c^e	Section 2.10, Efficiency, ANSI Z83.8
Warm-air unit heaters, gas fired	All capacities	Maximum capacity ^c	80% $E_c^{e,f}$	Section 2.10, Efficiency, ANSI Z83.8
Warm-air unit heaters, oil fired	All capacities	Maximum capacity ^c	80% $E_c^{e,f}$	Section 40, Combustion, UL 731

Table 11: IECC 2021 Water Heater Minimum Efficiency Requirements

TABLE C404.2
MINIMUM PERFORMANCE OF WATER-HEATING EQUIPMENT

EQUIPMENT TYPE	SIZE CATEGORY (input)	SUBCATEGORY OR RATING CONDITION	PERFORMANCE REQUIRED ^{a, b}	TEST PROCEDURE
Water heaters, electric	≤ 12 kW ^d	Tabletop ^e , ≥ 20 gallons and ≤ 120 gallons	0.93 – 0.00132V, EF	DOE 10 CFR Part 430
		Resistance ≥ 20 gallons and ≤ 55 gallons	0.960 – 0.0003V, EF	
		Grid-enabled ^f > 75 gallons and ≤ 120 gallons	1.061 – 0.00168V, EF	
	> 12 kW	Resistance	(0.3 + 27/V _m), %/h	ANSI Z21.10.3
	≤ 24 amps and ≤ 250 volts	Heat pump > 55 gallons and ≤ 120 gallons	2.057 – 0.00113V, EF	DOE 10 CFR Part 430
Storage water heaters, gas	≤ 75,000 Btu/h	≥ 20 gallons and ≤ 55 gallons	0.675 – 0.0015V, EF	DOE 10 CFR Part 430
		> 55 gallons and ≤ 100 gallons	0.8012 – 0.00078V, EF	
	> 75,000 Btu/h and ≤ 155,000 Btu/h	< 4,000 Btu/h/gal	80% E _t (Q/800 + 110.√V ³)SL, Btu/h	ANSI Z21.10.3
> 155,000 Btu/h	< 4,000 Btu/h/gal	80% E _t (Q/800 + 110.√V ³)SL, Btu/h		
Instantaneous water heaters, gas	> 50,000 Btu/h and < 200,000 Btu/h ^e	≥ 4,000 Btu/h/gal and < 2 gal	0.82 – 0.0019V, EF	DOE 10 CFR Part 430
	≥ 200,000 Btu/h	≥ 4,000 Btu/h/gal and < 10 gal	80% E _t	ANSI Z21.10.3
	≥ 200,000 Btu/h	≥ 4,000 Btu/h/gal and ≥ 10 gal	80% E _t (Q/800 + 110.√V ³)SL, Btu/h	
Storage water heaters, oil	≤ 105,000 Btu/h	≥ 20 gal and ≤ 50 gallons	0.68 – 0.0019V, EF	DOE 10 CFR Part 430
	≥ 105,000 Btu/h	< 4,000 Btu/h/gal	80% E _t (Q/800 + 110.√V ³)SL, Btu/h	ANSI Z21.10.3
Instantaneous water heaters, oil	≤ 210,000 Btu/h	≥ 4,000 Btu/h/gal and < 2 gal	0.59 – 0.0019V, EF	DOE 10 CFR Part 430
	> 210,000 Btu/h	≥ 4,000 Btu/h/gal and < 10 gal	80% E _t	ANSI Z21.10.3
	> 210,000 Btu/h	≥ 4,000 Btu/h/gal and ≥ 10 gal	78% E _t (Q/800 + 110.√V ³)SL, Btu/h	
Hot water supply boilers, gas and oil	≥ 300,000 Btu/h and < 12,500,000 Btu/h	≥ 4,000 Btu/h/gal and < 10 gal	80% E _t	ANSI Z21.10.3
Hot water supply boilers, gas	≥ 300,000 Btu/h and < 12,500,000 Btu/h	≥ 4,000 Btu/h/gal and ≥ 10 gal	80% E _t (Q/800 + 110.√V ³)SL, Btu/h	
Hot water supply boilers, oil	> 300,000 Btu/h and < 12,500,000 Btu/h	> 4,000 Btu/h/gal and > 10 gal	78% E _t (Q/800 + 110.√V ³)SL, Btu/h	

Time of Sale: The baseline for this measure is a new replacement unit of the same system type as the existing unit, meeting the minimum efficiencies provided above.

Early Replacement / Retrofit: The baseline for this measure is the efficiency of the *existing* heating, cooling, and hot water equipment for the assumed remaining useful life of the existing unit, and a new baseline heating and cooling system for the remainder of the measure life (as provided in tables above).

DEEMED LIFETIME OF EFFICIENT EQUIPMENT

The expected measure life of the gas heat pump is assumed to be 15 years for a natural gas heat pump¹⁰⁷⁶.

For early replacement, the remaining life of existing equipment is assumed to be 6 years for an air-source heat pump and Central A/C, 6 years for a furnace, and 8 years for boilers and ground source heat pumps.¹⁰⁷⁷

DEEMED MEASURE COST

New Construction and Time of Sale: Incremental costs of the gas heat pump should be used. This would be the actual installed cost of the heat pump equipment as well as system commissioning costs, minus the assumed installation cost of the baseline equipment.

Early Replacement: The actual installed cost of the gas heat pump should be used. The assumed deferred cost of replacing existing equipment with a new baseline is 1/3 of the incremental cost. This future cost should be discounted to present value using the nominal societal discount rate.

The incremental cost of gas heat pump over various replacement equipment is shown in **Table 7**¹⁰⁷⁸.

Table 7: Incremental Cost of Commercial Gas Heat Pump

Incremental Cost (\$/ton)		
Replaced Technologies	Installed Cost (\$/ton)	Incremental GHP Cost (\$/ton)
Rooftop Air Source Heat Pump	\$1,813	\$1,987
Ground Source Heat Pump	\$5,781	-\$1,981
Electric Boiler	\$250	\$3,550
Natural Gas Furnace	\$92	\$3,709
Natural Gas Boiler	\$594	\$3,206
Air-cooled Electric Chiller	\$988	\$2,813
Water-cooled Electric Chiller	\$550	\$3,250
Gas-fired Water Heater	\$384	\$3,416
Electric-resistance Water Heater	\$772	\$3,028
Gas Heat Pump	\$3,800	

Guide to read incremental cost:

Example 1: for a gas boiler and air-cooled electric chiller being replaced with a gas heat pump, the incremental cost will be (Cost of GHP) – (Cost of Natural Gas Boiler + Air-Cooled Electric Chiller) = \$3,800 – (\$594 + \$988) = \$2,218.

Example 2: for a gas boiler and gas-fired water heater being replaced with a gas heat pump, the incremental cost will be Cost of GHP – (Cost of Natural Gas Boiler + Gas Fired Water Heater) = \$3,800 – (\$594+\$384) = \$2,822.

LOADSHAPE

Depending on the baseline conditions, the appropriate loadshapes will be a combination of some, but not all, of the loadshapes below. Note for the purpose of cost-effectiveness screening for a fuel switching scenario, the cooling therm increase, and heating therm decrease should be calculated separately such as the appropriate loadshape (i.e.,

¹⁰⁷⁶ U.S. Energy Information Administration | Assumptions to the Annual Energy Outlook 2021: Commercial Demand Module: <https://www.eia.gov/outlooks/aeo/assumptions/pdf/commercial.pdf>

¹⁰⁷⁷ Assumed to be one third of effective useful life of replaced equipment.

¹⁰⁷⁸ U.S. Energy Information Administration (EIA), Updated Buildings Sector Appliance and Equipment Costs and Efficiencies: <https://www.eia.gov/analysis/studies/buildings/equipcosts/pdf/full.pdf>

Loadshape C04 – Commercial Electric Heating and Loadshape C03 – Commercial Cooling, respectively) can be applied.

Loadshape C02 – Commercial Electric SHW

Loadshape C03 – Commercial Cooling

Loadshape C04 – Commercial Electric Heating (if replacing building with no existing cooling)

Loadshape C05 – Commercial Electric Heating and Cooling

COINCIDENCE FACTOR

The summer peak coincidence factor for cooling is provided in two different ways below. The first is used to estimate peak savings during the utility peak hour and is most indicative of actual peak benefits. The second represents the average savings over the defined summer peak period and is presented so that savings can be bid into PJM’s capacity market. Both values provided are based on analysis of Itron eShape data for Missouri, calibrated to Illinois loads, supplied by Ameren.

$$CF_{SSP} = \text{Summer System Peak Coincidence Factor for Commercial Cooling (during system peak hour)}$$

$$= 91.3\%^{1079}$$

$$CF_{PJM} = \text{PJM Summer Peak Coincidence Factor for Commercial Cooling (average during peak period)}$$

$$= 47.8\%^{1080}$$

Algorithm

CALCULATION OF ENERGY SAVINGS

ELECTRIC ENERGY SAVINGS AND FOSSIL FUEL SAVINGS

Non-Fuel Switch Measures:

$$\Delta\text{therms} = \Delta\text{therms}_{SSPACE} + \Delta\text{therms}_{SHW}$$

Space Heating Savings

$$\Delta\text{therms}_{SSPACE} = \text{EFLH} * \text{Capacity} * ((\text{Efficiency}_{EE} - \text{Efficiency}_{Base}) / \text{Efficiency}_{Base}) / 100,000$$

Where:

- EFLH = Equivalent Full Load Hours for heating in Existing Buildings or New Construction are provided in section 4.4 HVAC End Use
 - Capacity = Nominal Heating Input Capacity Size (Btu/hr) for efficient unit not existing unit
= custom gas-fired heat pump input capacity (Btu/hr)
 - Efficiency_{Base} = Baseline Efficiency Rating, dependant on year and boiler type. See Table 4 above
 - Efficiency_{EE} = Rated Commerical Gas Heat Pump space heating efficiency, expressed as a fuel-input only COP_{Gas}, for the nominal capacity rating condition
- Hot water boiler baseline:

¹⁰⁷⁹ Values taken from established TRM references in section 4.4.44 and based on analysis of Itron eShape data for Missouri, calibrated to Illinois loads, supplied by Ameren. The AC load during the utility’s peak hour is divided by the maximum AC load during the year.

¹⁰⁸⁰ Values taken from established TRM references in section 4.4.44 and based on analysis of Itron eShape data for Missouri, calibrated to Illinois loads, supplied by Ameren. The average AC load over the PJM peak period (1-5pm M-F, June through August) is divided by the maximum AC load during the year.

Hot Water Boiler Capacity (Btu/hr)	Efficiency
Hot Water < 300,000 ¹⁰⁸¹	84% AFUE
300,000 ≤ Hot Water ≤ 2,500,000 ¹⁰⁸²	80% E _T
2,500,000 < Hot Water ¹⁰⁸³	82% E _C

For example, a 150,000 BTU/hr water boiler meeting COP_{Gas} 1.4 is installed in Rockford at a high-rise office building in the year 2022:

$$\begin{aligned} \Delta\text{Therms} &= 2,089 * 150,000 * (1.4 - 0.840) / 0.840 / 100,000 \text{ Btu/Therm} \\ &= 2,089.0 \text{ therms} \end{aligned}$$

Service Hot Water Savings:

$$\Delta\text{Therms}_{SHW} = \frac{(T_{out} - T_{in}) * \text{HotWaterUse}_{Gallon} * \gamma_{Water} * 1.0 * \left(\frac{1}{TE_{gasbase}} - \frac{1}{COP_{Eff}} \right)}{100,000}$$

Where:

T_{OUT} = Tank temperature
= 140°F

T_{IN} = Incoming water temperature from well or municipal system
= 50.7°F ¹⁰⁸⁴

HotWaterUse_{Gallon}
= Estimated annual hot water consumption (gallons)
= Actual, if possible to provide reasonable custom estimate. If not, two methodologies are provided to develop an estimate:

1. Consumption per usable storage tank capacity = Capacity * (Consumption/Cap)

Where:

Capacity = Usable capacity of hot water storage tank in gallons
= Actual

Consumption/Cap = Estimate of consumption per gallon of usable tank capacity, based on building type:¹⁰⁸⁵

Building Type ¹⁰⁸⁶	Consumption/Cap
Convenience	528
Education	568
Grocery	528
Health	788
Large Office	511

¹⁰⁸¹ Code of Federal Regulations, effective January 15, 2021 (10 CFR 432(e)(3)).

¹⁰⁸² Thermal Efficiency. Code of Federal Regulations, effective March 2, 2012 (10 CFR 431.87).

¹⁰⁸³ Combustion Efficiency. Code of Federal Regulations, effective March 2, 2012 (10 CFR 431.87).

¹⁰⁸⁴ Table 4 in Chen, et. al., “Calculating Average Hot Water Mixes of Residential Plumbing Fixtures”, June 2020, reports a value of 50.7°F for inlet water temperature for U.S. Census Division 3.

¹⁰⁸⁵ Methodology based on Cadmus analysis. Annual hot water usage in gallons based on CBECS (2012) and RECS (2009) consumption data of East North Central (removed outliers of 1,000 kBtu/h or less) to calculate hot water usage. Annual hot water gallons per tank size gallons based on the tank sizing methodology found in ASHRAE 2011 HVAC Applications. Chapter 50 Service Water Heating. Demand assumptions (gallons per day) for each building type based on ASHRAE Chapter 50 and to LBNL White Paper. LBL-37398 Technology Data Characterizing Water Heating in Commercial Buildings: Application to End Use Forecasting. Assumes hot water heater efficiency of 80%.

¹⁰⁸⁶ According to CBECS 2012 “Lodging” buildings include Dormitories, Hotels, Motel or Inns and other Lodging and “Nursing” buildings include Assisted Living and Nursing Homes.

Building Type ¹⁰⁸⁶	Consumption/Cap
Large Retail	528
Lodging	715
Other Commercial	341
Restaurant	622
Small Office	511
Small Retail	528
Warehouse	341
Nursing	672
Multi-Family	894

2. Consumption per unit area by building type = (Area / 1000) * Consumption/1,000ft²

Where:

Area = Area in ft² that is served by SHW boiler
 = Actual

Consumption/1,000ft² = Estimate of SHW consumption per 1,000ft² based on building type:¹⁰⁸⁷

Building Type ¹⁰⁸⁸	Consumption/1,000ft ²
Convenience	4,594
Education	7,285
Grocery	697
Health	24,540
Large Office	1,818
Large Retail	1,354
Lodging	29,548
Other Commercial	3,941
Restaurant	44,439
Small Office	1,540
Small Retail	6,111
Warehouse	1,239
Nursing	30,503
Multi-Family	15,434

γ_{Water} = Specific weight capacity of water (lb/gal) = 8.33 lbs/gal

1 = Specific heat of water (Btu/lb.°F)¹⁰⁸⁹

100,000 = Converts Btu to Therms

$T_{E_{\text{gasbase}}}$ = Rated efficiency of baseline water heater (expressed as Uniform Energy Factor (UEF) or Thermal Efficiency as provided below).

¹⁰⁸⁷ Methodology based on Cadmus analysis. Annual hot water usage in gallons based on CBECS (2012) and RECS (2009) consumption data of East North Central (removed outliers of 1,000 kBtu/h or less) to calculate hot water usage. Annual hot water gallons per tank size gallons based on the tank sizing methodology found in ASHRAE 2011 HVAC Applications. Chapter 50 Service Water Heating. Demand assumptions (gallons per day) for each building type based on ASHRAE Chapter 50 and to LBNL White Paper. LBL-37398 Technology Data Characterizing Water Heating in Commercial Buildings: Application to End Use Forecasting. Assumes hot water heater efficiency of 80%.

¹⁰⁸⁸ According to CBECS 2012 “Lodging” buildings include Dormitories, Hotels, Motel or Inns and other Lodging and “Nursing” buildings include Assisted Living and Nursing Homes.

¹⁰⁸⁹ Specific heat is the amount of heat required to change the temperature of a mass by one degree.

COP_{Eff} = Rated efficiency of the commercial gas heat pump as certified expressed as Uniform Energy Factor (UEF) or Coefficient of Performance as provided below.

Note the same draw pattern (very small, low, medium, and high draw) should be used for both baseline and efficient units.

Equipment Type	Sub-Category	Draw Pattern	Federal Standard – Uniform Energy Factor or Thermal Efficiency ¹⁰⁹⁰
<u>Residential-duty Commercial High-Capacity Storage Gas-Fired Storage Water Heaters >75,000 Btu/h</u>	≤120 gallon tanks	Very small	UEF = 0.2674 – (0.0009 * Rated Storage Volume in Gallons)
		Low	UEF = 0.5362 – (0.0012 * Rated Storage Volume in Gallons)
		Medium	UEF = 0.6002 – (0.0011 * Rated Storage Volume in Gallons)
		High	UEF = 0.6597 – (0.0009 * Rated Storage Volume in Gallons)
<u>Commercial Gas Storage Water Heaters >75,000 Btu/h</u>	>120 gallon tanks	All	80% $E_{thermal}$, Standby Losses = (Q / 800 + 110vRated Storage Volume in Gallons)
<u>Commercial Gas Storage Water Heaters >155,000 Btu/h</u>		All	
<u>Commercial Gas Instantaneous Water Heaters >200,000 Btu/h</u>	<10 gallon	All	80% $E_{thermal}$
	≥10 gallon	All	78% $E_{thermal}$

Draw patterns are based on first hour rating (gallons) for storage tanks and maximum flow (GPM) for instantaneous as shown below:¹⁰⁹¹

Storage Water Heater Draw Pattern	
Draw Pattern	First Hour Rating (gallons)
Very Small	≥ 0 and < 18
Low	≥ 18 and < 51
Medium	≥ 51 and < 75
High	≥ 75

Instantaneous Water Heater Draw Pattern	
Draw Pattern	Max GPM
Very Small	≥ 0 and < 1.7
Low	≥ 1.7 and < 2.8
Medium	≥ 2.8 and < 4

For example, for a 200,000 Btu/h, 150 gallon, GHP with a COP = 1.4 installed in a 1500 ft² restaurant:

$$\Delta \text{Therms} = ((140 - 50.7) * ((1,500/1,000) * 44,439) * 8.33 * 0.975 * (1/0.8 - 1/1.4))/100,000$$

$$= 259.0 \text{ Therms}$$

¹⁰⁹⁰ All Residential sized Federal Standards are from DOE Standard 10 CFR 430, Residential-Duty and Commercial Federal Standard are from DOE Standard 10 CFR 431.

¹⁰⁹¹ Definitions provided in 10 CFR 430, Subpart B, Appendix E, Section 5.4.1.

Fuel Switch Measures:

Fuel switching measures must produce positive total annual source fuel savings (i.e., reduction in source Btus) in order to qualify. This is determined as follows (note for early replacement measures the lifetime savings should be calculated by calculating savings for the remaining useful life of the existing equipment and for the remaining measure life):

$$\text{SourceEnergySavings (MMBTUs)} = (\text{ElectricHeatReplaced} - \text{GHPEnergyConsumed}_{\text{Heat}}) + (\text{ElectricCoolingReplaced} - \text{GHPEnergyConsumed}_{\text{Cool}}) + (\text{ElectricWaterHeatReplaced} - \text{GHPEnergyConsumed}_{\text{SHW}})$$

If SourceEnergySavings calculated above is positive, the measure is eligible.

Electric Space Heating Replaced with Natural Gas Heat Pump

$$\text{ElectricHeatReplaced [MMBTU}_{\text{source}}] = (\text{kBtu/hr}_{\text{heat}} * \text{EFLH}_{\text{heat}} * (1/\text{COP}_{\text{base}})) * 1000/3412 * (\text{LifetimeH}_{\text{grid}} * (1 + \text{ElectricT\&D}))/ 1,000,000$$

$$\text{GHPEnergyConsumed}_{\text{Heat}} [\text{MMBTU}_{\text{source}}] = ((\text{kBtu/hr}_{\text{heat}} * \text{EFLH}_{\text{heat}} * (1/\text{COP}_{\text{GHP}})) / 1000) * (1 + \text{GasSystemDistributionLoss})$$

Where:

- $\text{kBtu/hr}_{\text{heat}}$ = capacity of the heating equipment in kBtu per hour (1 ton of heating capacity equals 12 kBtu/hr).
- COP_{base} = Coefficient of performance of the baseline equipment, or thermal efficiency if applicable, at nominal condition
= based on the applicable Code on the date of equipment purchase (if unknown assume current Code). If rating is HSPF, $\text{COP} = \text{HSPF} / 3.413$
- $\text{EFLH}_{\text{Heat}}$ = Heating Equivalent Full Load Hours
= Dependent on building type and Existing Buildings or New Construction, provided in section 4.4 HVAC End Use
- COP_{GHP} = Coefficient of performance of the GHP equipment at nominal condition
= Actual installed
- $\text{LifetimeH}_{\text{grid}}$ = Average Heat rate of the grid in Btu/kWh over the lifetime of the measure. Used to calculate eligibility
= 7,700 BTU/kWh ¹⁰⁹²
- $\text{FirstYearH}_{\text{grid}}$ = Heat rate of the grid in BTU/kWh for first year of the measure. Used to calculate savings for first 6 years of measure life.
= 8,600 BTU / kWh ¹⁰⁹³

¹⁰⁹² Determination of the appropriate heat rate values for use in these calculations is complex and contentious. Lifetime grid heat rate was estimated based on review of multiple sources and methodologies, and represents the estimated average marginal grid heat rate over the lifetime of the measure. Note, if legislation is passed that dictates that fuel conversion calculations should be performed at site, the site conversion factor of 3,412 BTU/kWh shall be utilized in place of the grid heat rates presented here for the specified application and timeframe.

¹⁰⁹³ First year heat rate was estimated in 2021, based on review of multiple sources and methodologies, and represents the estimated IL grid marginal heat rate. Note, if legislation is passed that dictates that fuel conversion calculations should be performed at site, the site conversion factor of 3,412 BTU/kWh shall be utilized in place of the grid heat rates presented here for the specified application and timeframe.

PostAdjH _{grid}	= Heat rate of the grid in BTU/kWh for remaining years of the measure life. Used to calculated savings for remaining years of measure life resulting in approximately equal lifetime savings. = 7,200 BTU/kWh ¹⁰⁹⁴
ElectricT&D	= Electric marginal Transmission and Distribution Loss Factor = 10.7% (ComEd) = 11.3% (Ameren)
GasSystemDistributionLoss	= Gas System and Distribution Loss Factor = 0% ¹⁰⁹⁵

Electric Cooling Replaced with Natural Gas Heat Pump

$$\text{ElectricCoolingReplaced [MMBTU}_{\text{source}}] = (\text{kBtu/hr}_{\text{cool}} * \text{EFLH}_{\text{cool}} * (1/\text{EER}_{\text{base}})) * (\text{LifetimeH}_{\text{grid}} * (1 + \text{ElectricT\&D}))/ 1,000,000$$

$$\text{GHPEnergy Consumed}_{\text{cool}} [\text{MMBTU}_{\text{source}}] = ((\text{kBtu/hr}_{\text{cool}} * \text{EFLH}_{\text{cool}} * (1/\text{COP}_{\text{GHP}})) / 1000) * (1 + \text{GasSystemDistributionLoss})$$

kBtu/hr _{cool}	= capacity of the cooling equipment in kBtu per hour (1 ton of cooling capacity equals 12 kBtu/hr).
EER _{base}	= Energy Efficiency Ratio of the baseline equipment at nominal condition
EFLH _{cool}	= Equivalent Full Load Hours for cooling in Existing Buildings or New Construction are provided in section 4.4 HVAC End Use.
COP _{GHP}	= Coefficient of performance of the GHP equipment at nominal condition = Actual installed

Electric Water Heating Replaced with Natural Gas Heat Pump

$$\text{ElectricWaterHeatReplaced [MMBTU}_{\text{source}}] = ((T_{\text{out}} - T_{\text{in}}) * \text{HotWaterUse}_{\text{gallon}} * \gamma_{\text{Water}} * 1.0 * (1/\text{TE}_{\text{elecbase}})) / 3412 * (\text{LifetimeH}_{\text{grid}} * (1 + \text{ElectricT\&D}))/ 1,000,000$$

$$\text{GHPEnergyConsumed}_{\text{SHW}} [\text{MMBTU}_{\text{source}}] = (T_{\text{out}} - T_{\text{in}}) * \text{HotWaterUse}_{\text{gallon}} * \gamma_{\text{Water}} * 1.0 * (1/\text{COP}_{\text{GHP}}) / 1,000,000 * (1 + \text{GasSystemDistributionLoss})$$

**See previous nonfuel switch section for most descriptions

TE _{elecbase}	= Rated efficiency of baseline water heater expressed as Uniform Energy Factor (UEF) or Thermal Efficiency (TE) or Coefficient of Performance (COP), if not provided for resistance-type electric water heating assume TE _{elec,base} = 0.98
COP _{GHP}	= Coefficient of performance of the GHP equipment = Actual installed

¹⁰⁹⁴ Applying the first year heat rate for 6 years, followed by this PostAdjH_{grid} value for the remaining measure life produces a lifetime savings that is consistent with application of the lifetime heat rate provided. Note, if legislation is passed that dictates that fuel conversion calculations should be performed at site, the site conversion factor of 3,412 BTU/kWh shall be utilized in place of the grid heat rates presented here for the specified application and timeframe.

¹⁰⁹⁵ The 2021 TAC discussed whether it was appropriate to apply a factor to account for any marginal gas system and distribution losses relating to the gas savings in these equations. The TAC were unable to reach agreement and so this issue will be reviewed again next year. Since this is a new assumption, and likely to be a relatively small value, it was decided to set at 0% for 2022.

$$\text{Total Therm Savings} = \text{SourceEnergySavings} * 10 / (1 + \text{GasSystemDistributionLoss})$$

Example:

[for illustrative purposes, an ElectricT&D of 10.7%, GasSystemDistributionLoss of 1.4% is used]

A 3,000-squarefoot building with a 120 kBtu/hr output gas heat pump system replacing existing baseline equipment with COP of 1.3 in heating, cooling, and water heating in a Chicagoland public elementary school. The baseline equipment being replaced are all electric heating, cooling, and service hot water heater.

Baseline equipment efficiency: electric air source heating – 2.25 COP; electric air source cooling – 10.8 EER. Electric service hot water heater – 0.98 TE.

Heating Source MMBTU Savings = ElectricHeatReplaced - GHPEnergyConsumed_{Heat}

$$\begin{aligned} \text{ElectricHeatReplaced [MMBTU}_{\text{source}}] &= (\text{kBtu/hr}_{\text{heat}} * \text{EFLH}_{\text{heat}} * (1/\text{COP}_{\text{base}})) * 1000/3412 * \\ & \quad (\text{LifetimeH}_{\text{grid}} * (1 + \text{ElectricT\&D}))/ 1,000,000 \\ &= (120 * 1603 * (1/2.25)) * 1000/3412 * (7,700 * (1 + 0.107))/1,000,000 \\ &= 213.6 \text{ MMBtu} \end{aligned}$$

$$\begin{aligned} \text{GHPEnergyConsumed}_{\text{Heat}} [\text{MMBTU}_{\text{source}}] &= ((\text{kBtu/hr}_{\text{heat}} * \text{EFLH}_{\text{heat}} * (1/\text{COP}_{\text{GHP}})) / 1000) * (1 + \\ & \quad \text{GasSystemDistributionLoss}) \\ &= (120 * 1603 * 1/1.3)/1000 * (1 + 0.014) \\ &= 150.0 \text{ MMBtu} \end{aligned}$$

Cooling Source MMBTU Savings = ElectricCoolingReplaced- GHPEnergy Consumed_{cool}

$$\begin{aligned} \text{ElectricCoolingReplaced [MMBTU}_{\text{source}}] &= (\text{kBtu/hr}_{\text{cool}} * \text{EFLH}_{\text{cool}} * (1/\text{EER}_{\text{base}})) * (\text{LifetimeH}_{\text{grid}} * (1 + \\ & \quad \text{ElectricT\&D}))/ 1,000,000 \\ &= (120 * 837 * 1/10.8) * (7,700 * (1 + 0.107))/1,000,000 \\ &= 79.3 \text{ MMBtu} \end{aligned}$$

$$\begin{aligned} \text{GHPEnergy Consumed}_{\text{cool}} [\text{MMBTU}_{\text{source}}] &= ((\text{kBtu/hr}_{\text{cool}} * \text{EFLH}_{\text{cool}} * (1/\text{COP}_{\text{GHP}})) / 1000) * (1 + \\ & \quad \text{GasSystemDistributionLoss}) \\ &= (120 * 837 * 1/1.3) / 1000 * (1 + 0.014) \\ &= 78.3 \text{ MMBtu} \end{aligned}$$

Service Hot Water Heater Source MMBTU Savings = ElectricWaterHeatReplaced - GHPEnergyConsumed_{SHW}

$$\begin{aligned} \text{ElectricWaterHeatReplaced [MMBTU}_{\text{source}}] &= ((T_{\text{out}}-T_{\text{in}}) * \text{HotWaterUse}_{\text{gallon}} * \gamma_{\text{Water}} * 1.0 * \\ & \quad (1/\text{TE}_{\text{elecbase}})) / 3412 * (\text{LifetimeH}_{\text{grid}} * (1 + \text{ElectricT\&D}))/ \\ & \quad 1,000,000 \\ &= ((140 - 50.7) * (7285*3) * 8.33 * 1 * (1/0.98)) / 3412 * (7,700 * (1 + \\ & \quad 0.107))/1,000,000 \\ &= 41.4 \text{ MMBtu} \end{aligned}$$

$$\begin{aligned} \text{GHPEnergyConsumed}_{\text{SHW}} [\text{MMBTU}_{\text{source}}] &= ((T_{\text{out}}-T_{\text{in}}) * \text{HotWaterUse}_{\text{gallon}} * \gamma_{\text{Water}} * 1.0 * (1/\text{COP}_{\text{GHP}}) \\ & \quad / 1,000,000) * (1 + \text{GasSystemDistributionLoss}) \\ &= (((140 - 50.7) * (7285*3) * 8.33 * 1.0 * (1/1.3))/1,000,000) * (1 + 0.014) \\ &= 12.7 \text{ MMBtu} \end{aligned}$$

Example continued:

$$\begin{aligned} \text{Total Source MMBTU Savings} &= (213.6 - 150.0) + (79.3 - 78.3) + (41.4 - 12.7) \\ &= 93.3 \text{ MMBtu} \\ \\ \text{Total Therm Savings} &= 93.3 * 10 / (1 + 0.014) \\ &= 920.1 \text{ Therms} \end{aligned}$$

SUMMER COINCIDENT PEAK DEMAND SAVINGS

New Construction / Time of Sale:

$$\Delta kW = (\text{kBtu/hr} * (1/\text{EER}_{\text{base}})) * \text{CF}$$

Early Replacement / Retrofit:

$$\Delta kW = (\text{kBtu/hr} * (1/\text{EER}_{\text{exist}})) * \text{CF}$$

Where:

- EER_{base} = Energy Efficiency Ratio of the baseline equipment
- $\text{EER}_{\text{exist}}$ = Energy Efficiency Ratio of the existing equipment
= Actual, or assume Code base in place at the original time of existing unit installation
- CF_{SSP} = Summer System Peak Coincidence Factor for Commercial cooling (during system peak hour)
= 91.3% ¹⁰⁹⁶
- CF_{PJM} = PJM Summer Peak Coincidence Factor for Commercial cooling (average during peak period)
= 47.8% ¹⁰⁹⁷

For example, a 120 kBtu/hr electric air source cooling with a 10.8 EER replaced with a gas heat pump in Chicago would save:

$$\begin{aligned} \Delta kW_{\text{SSP}} &= (120 * (1 / 10.8)) * 0.913 \\ &= 10.14 \text{ kW} \end{aligned}$$

FOSSIL FUEL SAVINGS

Calculation provided together with Electric Energy Savings above.

WATER AND OTHER NON-ENERGY IMPACT DESCRIPTIONS AND CALCULATION

N/A

DEEMED O&M COST ADJUSTMENT CALCULATION

N/A. The installed cost of gas heat pump includes O&M agreement.

¹⁰⁹⁶ Based on analysis of Itron eShape data for Missouri, calibrated to Illinois loads, supplied by Ameren. The AC load during the utility’s peak hour is divided by the maximum AC load during the year.

¹⁰⁹⁷Based on analysis of Itron eShape data for Missouri, calibrated to Illinois loads, supplied by Ameren. The average AC load over the PJM peak period (1-5pm, M-F, June through August) is divided by the maximum AC load during the year.

COST EFFECTIVENESS SCREENING AND LOAD REDUCTION FORECASTING WHEN FUEL SWITCHING

This measure can involve fuel switching from electric to gas.

For the purposes of forecasting load reductions due to fuel switch HP projects; changes in site energy use at the customer’s meter (using ΔkWh algorithm below), customer switching estimates, NTG, and any other adjustment factors deemed appropriate, should be used.

The inputs to cost effectiveness screening should reflect the actual impacts on the electric and fuel consumption at the customer meter and, for fuel switching measures, should therefore reflect the decrease in one fuel and increase in another, as opposed to the single savings value calculated in the “Electric and Fossil Fuel Energy Savings” section above. Therefore in addition to the calculation of savings claimed, the following values should be used to assess the cost effectiveness of the measure. For Early Replacement measures, the efficiency terms of the existing unit should be used for the remaining useful life of the existing equipment (6 years for ASHP and Central AC, 6 years for furnace, 8 years for boilers or GSHP, 15 years for electric resistance), and the efficiency terms for a new baseline unit should be used for the remaining years of the measure.

$$\Delta\text{Therms} = [\text{Increased Consumption}]$$

$$\Delta\text{Therms} = - (\text{Therms}_{\text{SPACE}} + \text{Therms}_{\text{SHW}} + \text{Therms}_{\text{COOL}})$$

$$\text{Therms}_{\text{SPACE}} = ((\text{kBtu/hr}_{\text{heat}}) * 1/\text{COP}_{\text{GHP}} * \text{EFLH}_{\text{heat}}) * 1000 / 100,000$$

$$\text{Therms}_{\text{SHW}} = ((T_{\text{out}} - T_{\text{in}}) * \text{HotWaterUse}_{\text{gallon}} * \gamma_{\text{Water}} * 1 * (1/\text{COP}_{\text{GHP}})) / 100,000$$

$$\text{Therms}_{\text{COOL}} = ((\text{kBtu/hr}_{\text{cool}}) * 1/\text{COP}_{\text{GHP}} * \text{EFLH}_{\text{cool}}) * 1,000 / 100,000$$

$$\Delta\text{kWh} = [\text{Replaced Consumption}]$$

$$\Delta\text{kWh} = (\text{kWh}_{\text{SPACE}} + \text{kWh}_{\text{SHW}} + \text{kWh}_{\text{COOL}})$$

$$\text{kWh}_{\text{SPACE}} = (\text{kBtu/hr}_{\text{heat}}) / 3.412 * 1/\text{COP}_{\text{base}} * \text{EFLH}_{\text{heat}}$$

$$\text{kWh}_{\text{SHW}} = ((T_{\text{out}} - T_{\text{in}}) * \text{HotWaterUse}_{\text{gallon}} * \gamma_{\text{Water}} * 0.975 * (1/\text{TE}_{\text{elecbase}})) / 3413$$

$$\text{kWh}_{\text{COOL}} = (\text{kBtu/hr}_{\text{cool}}) * (1/\text{EER}_{\text{base}}) * \text{EFLH}_{\text{cool}}$$

MEASURE CODE: CI-HVC-GFHP-V04-250101

REVIEW DEADLINE: 1/1/2027

4.4.56 Commercial Duct Sealing

DESCRIPTION

This measure was developed to reduce the heating and cooling losses from ducts running through un-conditioned spaces, including, but not limited to: unheated/uncooled attics, basements or crawlspaces; or the outdoors. To the extent that the duct runs through a conditioned space, such as occupied rooms, between conditioned building floors, or semi-heated or semi-cooled spaces, this measure is not applicable as it is assumed that all heating or cooling losses from the duct perform beneficial heating or cooling to the conditioned space. This assumption ignores the potential overheating and overcooling of the conditioned space, which energy waste is hereby deemed to be negligible.¹⁰⁹⁸

This measure was developed to be applicable to the following program types: RF.

If applied to other program types, the measure savings should be verified.

DEFINITION OF EFFICIENT EQUIPMENT

The efficient case is installing duct wrap or other insulation to a length of HVAC ductwork. If applied to ductwork that currently, or in the future may transmit cooling air, the insulation must be wrapped with an impermeable vapor barrier.

The efficient duct air sealing case is installing elastomeric sealant externally to cracks and holes in ductwork that completely and permanently seals the ductwork from air leakage. The elastomeric material must remain flexible and adhere to the ductwork during the measure lifetime and to withstand significant swings in ductwork temperature without losing its sealing capability.

DEFINITION OF BASELINE EQUIPMENT

Baseline equipment is an uninsulated and/or un-sealed duct located within an un-conditioned space. If a duct has previously been insulated but a significant portion of the insulation has deteriorated or fallen off, the program shall verify the duct insulation condition and determine whether the duct can be considered “un-insulated” for purposes of applying for an incentive.

DEEMED LIFETIME OF EFFICIENT EQUIPMENT

The measure life is assumed to be 20 years.¹⁰⁹⁹

DEEMED MEASURE COST

The actual installation cost should be used if known. If unknown, the measure cost for duct insulation, including material and installation, is assumed to be \$8.00 per square foot¹¹⁰⁰ and for duct crack sealing, including materials and installation, is assumed to be \$15.00 per linear foot.¹¹⁰¹

LOADSHAPE

Loadshape C01 – Commercial Electric Cooling

Loadshape C03 – Commercial Cooling

Loadshape C04 – Commercial Electric Heating

Loadshape C05 – Commercial Electric Heating and Cooling

¹⁰⁹⁸ It is recommended that additional analyses be considered using custom analysis to determine the extent of overheating or overcooling from uninsulated or unsealed ductwork running through conditioned spaces.

¹⁰⁹⁹ Measure Life Report, Residential and Commercial/Industrial Lighting and HVAC Measures, GDS Associates, June 2007.

¹¹⁰⁰ Engineering estimate provided by John Johnson.

¹¹⁰¹ Engineering estimate provided by John Johnson.

COINCIDENCE FACTOR

The summer peak coincidence factor for cooling is provided in two different ways below. The first is used to estimate peak savings during the utility peak hour and is most indicative of actual peak benefits, and the second represents the *average* savings over the defined summer peak period, and is presented so that savings can be bid into PJM’s capacity market. Both values provided are based on analysis of Itron eShape data for Missouri, calibrated to Illinois loads, supplied by Ameren.

- CF_{SSP} = Summer System Peak Coincidence Factor for Commercial cooling (during system peak hour)
= 91.3% ¹¹⁰²
- CF_{PJM} = PJM Summer Peak Coincidence Factor for Commercial cooling (average during peak period)
= 47.8% ¹¹⁰³

Algorithm

CALCULATION OF ENERGY SAVINGS

ELECTRIC ENERGY SAVINGS

Where available, savings from duct Insulation measures should be determined through a custom analysis. When that is not feasible for the program, the following engineering algorithms can be used.

$$\Delta kWh = \Delta kWh_{cooling} + \Delta kWh_{heatingElectric} + \Delta kWh_{heatingGas}$$

Where:

$$\Delta kWh_{cooling} = \text{If building is cooled, reduction in annual cooling requirement due to duct insulation}$$

$$= ((1 / R_{Duct_{Exist}} - 1 / R_{Duct_{Efficient}}) * A_{Duct} + 1.08 * CFM_{Saved} * EFLH_{Cool} * (Avg_{Clg_OAT} - Avg_{Duct_Clg_SAT})) / 1000 / \eta_{Cool} * \%Cool$$

Where:

- R_{DuctEfficient} = Average R-value of proposed duct assembly after installation of additional insulation
= Actual
- R_{DuctExist} = Average R-value value of existing duct assembly, including any existing insulation
= if duct is uninsulated, the average R-value deemed to be 0.8 hr-sf-F/BTU¹¹⁰⁴
- A_{Duct} = Net area of duct proposed to be insulated (ft²)
= Actual
- 1.08 = Specific heat of air x density of inlet air @ 70F x 60 min/hr in BTU
- CFM_{Saved} = Quantity of duct leakage saved by application of crack sealant to previously unsealed ductwork

¹¹⁰² Based on analysis of Itron eShape data for Missouri, calibrated to Illinois loads, supplied by Ameren. The AC load during the utility’s peak hour is divided by the maximum AC load during the year.

¹¹⁰³ Based on analysis of Itron eShape data for Missouri, calibrated to Illinois loads, supplied by Ameren. The average AC load over the PJM peak period (1-5pm, M-F, June through August) is divided by the maximum AC load during the year.

¹¹⁰⁴ ASHRAE. Inside duct air film assumed to be <0.1 hr-sf-F/BTU; Outside of duct assumed to be in still air with air film R-value of 0.79 hr-sf-F/BTU,

= CFM/Ft for average crack width from table below¹¹⁰⁵, adjusted for actual duct internal pressure¹¹⁰⁶ * Length of Crack (Ft.)

Average Crack Width (Inches)	CFM Air Leakage per Foot of Crack @ 0.3" w.c. duct
0.00	0 CFM
0.05	7 CFM
0.10	13 CFM
0.15 (Default if Unknown)	20 CFM
0.20	26 CFM
0.25	33 CFM
0.30	39 CFM
0.35	46 CFM
0.40	52 CFM
0.45	59 CFM
0.50	65 CFM
Unknown	20 CFM

EFLH_{Cool} = Equivalent Full Load Hours for cooling in Existing Buildings are provided in section 4.4 HVAC End Use

Avg_Clg_OAT = Deemed average ambient air temperature over the cooling season in the building space through which the HVAC duct runs, based on climate zone:¹¹⁰⁷

Climate Zone	Cooling Season Avg OA DBT
1 - Rockford	71.3 degF
2 - Chicago	73.7 degF
3 - Springfield	70.7 degF
4 - Belleville	76.3 degF
5 - Marion	69.0 degF

Avg_Duct_Clg_SAT = 60 degF.¹¹⁰⁸

¹¹⁰⁵ ASHRAE Fundamentals (2017), Page 16.28, Fig 14. Elevator door CFM assumed to apply to low-rise commercial buildings. Straight line regression analysis was used by ASHRAE: CFM values from 0.0" to 0.2" crack width for personnel doors; and CFM values from 0.0" to 0.3" crack width for elevator doors. The same straight line regression formula is assumed to apply to larger crack widths up to 0.5.

¹¹⁰⁶ ASHRAE Fundamentals (2017), Page 16.28, Fig. 14: "For other dP, Multiply Leakage Rate by (dP/0.3)^{0.55}".

¹¹⁰⁷ BinMaker Pro weather data, based on average outdoor air temperatures over the hottest 5 calendar months. Outdoor average temperatures is assumed to be equivalent to the average temperatures of typical duct locations in: attics, basements, crawl spaces and outdoors. Additional research is recommended to verify actual average ambient temperatures in these areas; additional inputs may be recommended to identify the actual space type of the duct and create a lookup table based on space type and climate zone.

¹¹⁰⁸ Engineering estimate by John Johnson – Leidos, based on estimate of average supply air temperature, both for continuous fan operation scenarios and automatic on/off fan operation scenarios. Additional research is recommended to verify actual average duct cooling supply temperatures; additional inputs may be recommended to identify HVAC fan control modes and create a lookup table based on fan control mode type and climate zone.

- 24 = Converts days to hours
- 1000 = Converts Btu to kBtu
- η_{Cool} = Efficiency of cooling system. Actual, if known. Alternatively, use IECC 2012 as a default source if equipment type is known, or as deemed from table below¹¹⁰⁹

Space Cooling / Heating Source	Deemed Cooling EER	Deemed Cooling SEER
No Cooling	N/A	N/A
Unknown Cooling Source	11	13

- %Cool = Percent of building **where duct insulation is to be installed** that is cooled
- = Actual %, if known, or, If actual % unknown, use following deemed values:

Is Space Being Insulated Cooled?	Deemed %Cool, if actual % is unknown
Yes	100%
No	0%

For example, insulating an uninsulated 300 ft² duct and sealing 473 cfm leakage for an Assembly Building Type in Rockford with unknown cooling system: $R_{DuctExist} = 0.8$; $R_{DuctEfficient} = 12.8$; $A_{Duct} = 300$; $CFM_{Saved} = 473$; $EFLH_{Cool} = 725$; $Avg_Clg_OAT = 71.3$; $Avg_Duct_Clg_SAT = 60$; $\eta_{Cool} = 13.0$; %Cool = 100%

$$\Delta kWh_{cooling} = ((1 / 0.8 - 1 / 12.8) * 300 + 1.08 * 473) * 725 * (71.3 - 60) / 1000 / 13.0 * 100\%$$

$$= 543 \text{ kWh}$$

$\Delta kWh_{heatingElectric}$ = If electric heat (resistance or heat pump), reduction in annual electric heating due to wall and/or foundation insulation

$$= [(1 / R_{DuctExist} - 1 / R_{DuctEfficient}) * A_{Duct} + 1.08 * CFM_{Saved}] * EFLH_{Heat} * (Avg_Duct_Htg_SAT - Avg_Htg_OAT) / \eta_{Heat} / 3412 * \%ElectricHeat$$

Where:

- $EFLH_{Heat}$ = Equivalent Full Load Hours for heating in Existing Buildings are provided in section 4.4 HVAC End Use
- Avg_Htg_OAT = Deemed average ambient air temperature over the cooling season in the building space through which the HVAC duct runs, based on climate zone:¹¹¹⁰

¹¹⁰⁹ Simplified version of IECC 2012 as a conservative estimate of what is existing

¹¹¹⁰ BinMaker Pro weather data, based on average outdoor air temperatures over the hottest 5 calendar months. Outdoor average temperatures is assumed to be equivalent to the average temperatures of typical duct locations in: attics, basements, crawl spaces and outdoors. Additional research is recommended to verify actual average ambient temperatures in these areas; additional inputs may be recommended to identify the actual space type of the duct and create a lookup table based on space type and climate zone.

Climate Zone	Heating Season Avg OA DBT
1 - Rockford	29.4 degF
2 - Chicago	34.2 degF
3 - Springfield	27.4 degF
4 - Belleville	38.4 degF
5 - Marion	31.4 degF

Avg_Duct_Htg_SAT = 85 degF.¹¹¹¹

η_{Heat} = Efficiency of heating system, as deemed from table below

System Type	Cooling Capacity of Equipment	Age of Equipment	HSPF Estimate	η (Effective COP Estimate) (HSPF/3.413)
Heat Pump ¹¹¹²	All	Before 2009	6.8	2.0
	< 65,000 Btu/h	2009 - 2017	7.7	2.3
		2017 on	8.2	2.40
	$\geq 65,000$ Btu/h and < 135,000 Btu/h	2010 on	11.3	3.3
	$\geq 135,000$ Btu/h and < 240,000 Btu/h	2010 on	10.9	3.2
$\geq 240,000$ Btu/h and < 760,000 Btu/h	2010 on	10.9	10.9	3.2
Resistance	N/A	N/A	N/A	1
Natural Gas Furnace or Boiler	N/A	N/A	N/A	0.8 E_T

3412 = Converts Btu to kWh

%ElectricHeat = Percent of building ***where duct insulation is to be installed*** that is electrically heated

= Actual %, if known, or, If actual % unknown, use following deemed values:

Is Space Being Insulated Electrically Heated?	Deemed %ElectricHeat, if actual % is unknown
Yes	100%
No	0%

¹¹¹¹ Engineering estimate by John Johnson – Leidos, based on estimate of average supply air temperature, both for continuous fan operation scenarios and automatic on/off fan operation scenarios. Additional research is recommended to verify actual average duct heating supply temperatures; additional inputs may be recommended to identify HVAC fan control modes and create a lookup table based on fan control mode type and climate zone.

¹¹¹² Minimum heating efficiency standards for heat pumps are sourced from the Code of Federal Standards for Small and Large Commercial Package Air Conditioning and Heating Equipment (Air Cooled), 10 CFR 431.97 with compliance dates of June 16, 2008; January 1, 2010; January 1, 2017; and January 1, 2018. As the first federal appliance standards for heating efficiency for commercial heat pumps went into effect in June 2008, assuming efficiency standards equivalent to residential heat pumps prior to that date.

For example, insulating an uninsulated 300 ft² duct and sealing 473 cfm leakage for an Assembly Building Type in Rockford with electric resistance heating system: R_DuctExist = 0.8; R_DuctEfficient = 12.8; A_Duct = 300; CFM_Saved = 473; EFLH_{Heat} = 1787; Avg_Htg_OAT = 29.4; Avg_Duct_Htg_SAT = 85; η_{Heat} = 1.0; %Electric Heat = 100%

$$\begin{aligned} \Delta\text{kWh}_{\text{heatingElectric}} &= ((1 / 0.8 - 1 / 12.8) * 300 + 1.08 * 473) * 1787 * (85 - 29.4) / 3412 / 1.0 * 100\% \\ &= 25,100 \text{ kWh} \end{aligned}$$

$$\begin{aligned} \Delta\text{kWh}_{\text{heatingGas}} &= \text{If gas furnace or boiler heat, kWh savings for reduction in combustion fan run time} \\ &= \Delta\text{Therms} * F_e * 29.3 \end{aligned}$$

Where:

ΔTherms = Annual therms of gas space heating saved, as determined below

F_e = Furnace or boiler combustion fan energy consumption as a percentage of annual fuel consumption
= 7.7%

29.3 = conversion of therms to kWh (= 100000 / 3412)

Other variables as defined above

For example, if: ΔTherms = 1072; F_e = 7.7%, then:

$$\begin{aligned} \Delta\text{kWh}_{\text{heatingGas}} &= 1072 * 7.7\% * 29.3 \\ &= 2419 \text{ kWh} \end{aligned}$$

For example, based on the above calculations with electric resistance heat, total annual kWh savings =

$$\begin{aligned} \text{Total Annual kWh Savings} &= 787 + 25,100 + 0 \\ &= 25,643 \text{ kWh} \end{aligned}$$

SUMMER COINCIDENT PEAK DEMAND SAVINGS

$$\Delta\text{kW} = \Delta\text{kWh}_{\text{cooling}} / \text{EFLH}_{\text{Cooling}} * \text{CF}$$

Where:

ΔkWh_{cooling} = Annual kWh saving in cooling energy use, as determined above

EFLH_{cooling} = Equivalent Full Load Hours for cooling in Existing Buildings are provided in section 4.4 HVAC End Use

CF_{SSP} = Summer System Peak Coincidence Factor for Commercial cooling (during system peak hour)
= 91.3% ¹¹¹³

¹¹¹³ Based on analysis of Itron eShape data for Missouri, calibrated to Illinois loads, supplied by Ameren. The AC load during the utility's peak hour is divided by the maximum AC load during the year.

$$CF_{PJM} = \text{PJM Summer Peak Coincidence Factor for Commercial cooling (average during peak period)}$$

$$= 47.8\%^{1114}$$

For example based on example above: $\Delta kWh_{cooling} = 543$; $EFLH_{Cooling} = 725$; $CF = 0.478$; then:

$$\text{Summer Coincident Peak savings} = 543 / 725 * 0.478$$

$$= 0.36 \text{ kW}$$

FOSSIL FUEL SAVINGS

If Natural Gas heating:

$$\Delta \text{Therms} = [(1 / R_{Duct_{Exist}} - 1 / R_{Duct_{Efficient}}) * A_{Duct} + 1.08 * CFM_{Saved}] * EFLH_{Heat} * (Avg_{Duct}_{Htg}_{SAT} - Avg_{Htg}_{OAT}) / \eta_{Heat} / 100,000 * \%GasHeat$$

Where:

$\%GasHeat$ = Percent of space being retrofitted with insulation that is heated using gas
 = Actual %, if known, or, If actual % unknown, use following deemed values:

Is Space Being Insulated Heated with Gas?	Deemed %GasHeat, if actual % is unknown
Yes	100%
No	0%

Other variables as defined above

For example, insulating an uninsulated 300 ft² duct and sealing 473 cfm leakage for an Assembly Building Type in Rockford with unknown gas heating system: $R_{ExistWall} = 0.8$; $R_{NewWall} = 12.8$; $A_{Duct} = 300$; $CFM_{Saved} = 473$; $EFLH_{Heat} = 1787$; $Avg_{Htg}_{OAT} = 29.4$; $Avg_{Duct}_{Htg}_{SAT} = 85$; $\eta_{Heat} = 0.8$; $\%GasHeat = 100\%$; then
 Annual Therm Savings = $((1 / 0.8 - 1 / 12.8) * 300 + 1.08 * 473) * 1787 * (85 - 31.4) / 0.8 / 100,000 * 100\%$
 = 1072 therms

WATER AND OTHER NON-ENERGY IMPACT DESCRIPTIONS AND CALCULATION

N/A

DEEMED O&M COST ADJUSTMENT CALCULATION

N/A

MEASURE CODE: CI-HVC-DSEAL-V02-250101

REVIEW DEADLINE: 1/1/2026

¹¹¹⁴ Based on analysis of Itron eShape data for Missouri, calibrated to Illinois loads, supplied by Ameren. The average AC load over the PJM peak period (1-5pm, M-F, June through August) is divided by the maximum AC load during the year.

4.4.57 Condensate Recovery System

DESCRIPTION

This measure is applied to hot water and steam fossil-fuel fired boiler where partial or no condensate is returned. As more condensate is returned into the boiler system, less make-up water is required, saving fossil-fuel, make-up water chemical, and treatment cost¹¹¹⁵. Less condensate discharged into the sewer also means reduced disposal costs and reduction in energy losses due to energy blowdown¹¹¹⁶. The measure is applicable to commercial applications, commercial HVAC including multifamily buildings, low pressure applications, medium pressure industrial applications, and high-pressure industrial applications.

This measure was developed to be applicable to the following program types: TOS, RF. If applied to other program types, the measure savings should be verified.

DEFINITION OF EFFICIENT EQUIPMENT

The efficient equipment is defined as functional steam or hot water system that increase the return of condensate in comparison to the baseline case. New systems are not eligible for this measure.

DEFINITION OF BASELINE EQUIPMENT

Baseline is an existing steam or hot water boiler system where minimal or no condensate is returned.

DEEMED LIFETIME OF EFFICIENT EQUIPMENT

The expected measure life is assumed to be 15 years¹¹¹⁷.

DEEMED MEASURE COST

If known, the actual material and labor cost of installation should be used. If unknown, the average measure cost per GPM of condensate returned is \$4,861¹¹¹⁸. This cost includes material and labor for installing condensate recovery systems (storage tanks, pipes and pumps).

LOADSHAPE

Loadshape C35 – Industrial Process

Loadshape C36 – HVAC Pump motor (heating)

COINCIDENCE FACTOR

For process boiler systems, the summer peak coincidence factor for this measure is dependent on the industrial shift and corresponding hours of operation. Values are provided for each shift type in the variable definition section.

N/A for space heating boiler systems.

¹¹¹⁵ Vineeth C, M G Prince. Impact of Condensate Recovery on Boiler Fuel Consumption in Textile Sector. Vol. 3. Issue 5

¹¹¹⁶ U.S. DOE. Return Condensate to the Boiler. [Energy.gov/sites/prod/files/2014/05/f16/steam8_boiler.pdf](https://www.energy.gov/sites/prod/files/2014/05/f16/steam8_boiler.pdf)

¹¹¹⁷ Table 4 Chapter 36, Comparison of Service Life Estimates, 2007 ASHRAE Handbook, HVAC Applications

¹¹¹⁸ Results from Condensate Recovery efficiency improvement research through the C&I and Public Sector Custom Rebate Program, and Small Business Program. The evaluation included project and population data from years 2016 – 2022.

Algorithm

CALCULATION OF ENERGY SAVINGS

ELECTRIC ENERGY SAVINGS

This measure results in additional electric use due to the addition of the condensate pump.

$$\Delta kWh = - \left(HP_{\text{motor}} \times 0.746 \times \frac{LF}{\eta_{\text{motor}}} \right) \times \text{hours}$$

Where:

HP_{motor} = Installed nameplate motor horsepower

= Actual. If unknown:

E.D.R (sq. ft)	Pump ¹¹¹⁹ USGPM	Pump Discharge Pressure PSI	Motor ¹¹²⁰ HP
Boiler HP			3500 RPM
BTUH (1000's)			
lbm _{steam} /hr			
1,000	1.50	10	1/2
7		20	1/2
240		30	1/2
250		40	3/4
2,000	3.00	10	1/2
14		20	1/2
480		30	1/2
500		40	3/4
		50	1 1/2
4,000	6.00	10	1/2
29		20	1/2
960		30	1/2
1,000		40	3/4
		50	1 1/2
6,000	9.00	10	1/2
43		20	1/2
1,440		30	1/2
1,500		40	3/4
		50	1 1/2
10,000	15.00	10	1/2
71		20	1/2

¹¹¹⁹ Condensate pumps are rated in square feet EDR. To convert boiler rating to square feet EDR use the following conversion factors:

Multiply boiler horsepower (BHP) by 140 to get square feet EDR

Divide Btu/h by 240 to get square feet EDR

Multiply lbs of steam per hour by 4 to get square feet EDR

A boiler can put out half a gallon per 1000 sq ft EDR per minute. Size the pump capacity for twice to three times the return rate. Then assign a motor HP based on the system's pressure requirement.

¹¹²⁰ Steve Almgreen. "How to size a condensate return unit" Xylem Inc, 2015. Steam Team Products

E.D.R (sq. ft)	Pump ¹¹¹⁹ USGPM	Pump Discharge Pressure PSI	Motor ¹¹²⁰
Boiler HP			HP
BTUH (1000's)			3500
lbm _{steam} /hr			RPM
2,400		30	1/2
2,500		40	1
		50	2
20,000	30.00	10	1/2
143		20	1/4
4,800		30	1
5,000		40	1 1/2
		50	2
25,000	37.50	10	3/4
179		20	1
6,000		30	1 1/2
6,250		40	1 1/2
		50	2 1/2
30,000	45.00	10	3/4
214		20	1
7,200		30	1 1/2
7,500		40	2 1/2
		50	5
40,000	60.00	10	1 1/2
286		20	1 1/2
9,600		30	2
10,000		40	5
		50	5
50,000	75.00	10	2
357		20	2
12,000		30	3
12,500		40	5
		50	7 1/2
65,000	97.50	10	2
464		20	2 1/2
15,600		30	2 1/2
16,250		40	5
		50	7 1/2
		60	7 1/2
80,000	120.00	10	2 1/2
571		20	2 1/2
19,200		30	2 1/2
20,000		40	5
		50	7 1/2

E.D.R (sq. ft)	Pump ¹¹¹⁹ USGPM	Pump Discharge Pressure PSI	Motor ¹¹²⁰ HP
Boiler HP			3500
BTUH (1000's)			RPM
lbm _{steam} /hr			
		60	7 1/2
100,000	150.00	10	3
714		20	3
24,000		30	3
25,000		40	5
		50	7 1/2
		60	10

0.746 = Conversion factor from horsepower to kW (kW/hp)

$\frac{LF}{\eta_{motor}}$ = Combined as a single factor since efficiency is a function of load

Where:

LF = Load Factor; Ratio of the peak running load to the nameplate rating of the motor

= Actual, or if unknown 0.65¹¹²¹

η_{motor} = Motor efficiency at pump operating conditions

= Actual

HOURS = Annual operating hours of the pump

For space heating

= Operating hours of heating system

For other processes

= Actual. If unknown:

Shift	Hours
Single shift (8/5)	1,976 hours 7 AM – 3 PM, weekdays, minus some holidays and scheduled down time
2-shift (16/5)	3,952 hours 7AM – 11 PM, weekdays, minus some holidays and scheduled down time
3-shift (24/5)	5,928 hours 24 hours per day, weekdays,
4-shift (24/7)	8,320 hours 24 hours/day, 7 days a week minus some holidays and scheduled down time
Unknown / Weighted average ¹¹²²	5,702 hours

¹¹²¹ “Measured Loading of Energy Efficient Motors - the Missing Link in Engineering Estimates of Savings,” ACEEE 1994 Summer Study Conference, Asilomar, CA.

¹¹²² Weighting of 16% single shift, 23% two shift, 25% three shift and 36% continual based on DOE evaluation of the Compressed Air Challenge, section 2.1.5 Facility Operating Schedules.

SUMMER COINCIDENT PEAK DEMAND SAVINGS

$$\Delta kW = - \left(HP_{\text{motor}} \times 0.746 \times \frac{LF}{\eta_{\text{motor}}} \right) \times CF$$

Where:

CF = Summer Coincident Peak Factor for measure

FOSSIL FUEL SAVINGS (WATER SAVINGS MUST BE CALCULATED FIRST)

Fossil-fuel savings are calculated by estimating the amount of water that is discharged into the sewer. Savings are calculated on the enthalpy difference between make-up water and condensate temperature.

$$\Delta \text{Therms} = \frac{\Delta \text{Water} \times 8.33 \times (H_r - H_w) \times (1 - S_{\text{loss}})}{\eta_{\text{boiler}} \times 100,000}$$

The calculated water savings (in gallons/year) is in turn, used to calculate fossil-fuel savings. The condition of condensate recovery systems varies widely between facilities. Flow meter readings or make-up water records are required for accurate calculations. For condensate systems where partial condensate is returned, a custom calculation is suggested.

$$\Delta \text{Water} = \left[\frac{\text{EFLH} \times \text{Capacity}}{[(H_s - H_r)(\% \text{Existing}) + (H_s - H_w)(1 - \% \text{Existing})] \times 8.33} \right] \left[\frac{\% \text{Proposed} - \% \text{Existing}}{1 - \% \text{Existing}} \right]$$

ΔWater = Condensate water (gal) discharged into sewer that is saved after recovery systems are in place.

8.33 = specific mass in pounds of one gallon of water (lbm/gal)
= Actual if known.

EFLH = Equivalent Full Load hours for heating in Existing Buildings are provided in section 4.4 HVAC End Use

Capacity = Nominal Heating Input Capacity Boiler Size (Btu/hr) for existing unit
= Custom Boiler input capacity in btu/hr

H_s = Enthalpy of supplied steam or hot water¹¹²³, (Btu/lbm)

System Type	Supply Fluid temperature ^{1124,1125} (°F)	Enthalpy of steam or hot water (Btu/lbm)
Hot Water space heating with outdoor reset - Non recirculation	155	123
Hot Water space heating without outdoor reset - Non recirculation	180	148
Hot Water space heating with outdoor reset – Recirculation heating season only	155	123
Hot Water space heating without outdoor reset – Recirculation heating season only	180	148

¹¹²³ Taken from IL TRM Measure 4.4.14 Pipe Insulation

¹¹²⁴ A typical design uses a $\Delta 20^\circ\text{F}$ from hot water supply temperature to return temperature. ASHRAE. Boiler System Efficiency. 2006. <http://goesheatingsystems.com/wp-content/uploads/2015/04/BoilerEfficiencyArticle.pdf>

¹¹²⁵ Typical hot water boiler operating temperature is 180°F . ASHARE. Boiler system Efficiency. 2006. <http://goesheatingsystems.com/wp-content/uploads/2015/04/BoilerEfficiencyArticle.pdf>

System Type	Supply Fluid temperature ^{1124,1125} (°F)	Enthalpy of steam or hot water (Btu/lbm)
Hot Water space heating with outdoor reset – Recirculation year-round	140	108
Hot Water space heating without outdoor reset – Recirculation year-round	180	148
Domestic Hot Water	135	103
5 psi Steam (low pressure)	225	1,155
15 psi Steam (low pressure)	250	1,163
40 psi Steam (low pressure)	287	1,176
65 psi Steam (high pressure)	312	1,183
100 psi Steam (high pressure)	338	1,190

H_r = Enthalpy of return hot water or steam (Btu/lbm)

The condensate fluid temperature assumption used depends upon both the system type and whether there are outdoor reset controls¹¹²⁶:

System Type	Return Fluid Temperature ¹¹²⁷ (°F)	Enthalpy of condensate (Btu/lbm)
Hot Water space heating with outdoor reset - Non recirculation	135	103
Hot Water space heating without outdoor reset - Non recirculation	160	128
Hot Water space heating with outdoor reset – Recirculation heating season only	135	103
Hot Water space heating without outdoor reset – Recirculation heating season only	160	128
Hot Water space heating with outdoor reset – Recirculation year-round	120	88
Hot Water space heating without outdoor reset – Recirculation year-round	160	128
Domestic Hot Water	115	83
5 psi Steam (low pressure)	225	193
15 psi Steam (low pressure)	250	219
40 psi Steam (low pressure)	287	256
65 psi Steam (high pressure)	312	282
100 psi Steam (high pressure)	338	309
150 psi Steam (high pressure)	365	338

H_w = Enthalpy of incoming water from well or municipal system (Btu/lbm)
 = 18.8 Btu/lbm for an incoming water temperature of 50.7°F¹¹²⁸

S_{loss} = Percentage of flash steam loss
 = 12%¹¹²⁹ or actual if known.

%existing = Percentage of existing condensate recovery
 = 0% if no condensate is recovered or Actual If known

¹¹²⁶ Taken from IL TRM Measure 4.4.14 Pipe Insulation

¹¹²⁷ A typical design uses a $\Delta 20^\circ\text{F}$ from hot water supply temperature to return temperature. ASHRAE. Boiler System Efficiency. 2006. <http://goeshheatingsystems.com/wp-content/uploads/2015/04/BoilerEfficiencyArticle.pdf>

¹¹²⁸ Table 4 in Chen, et. al., "Calculating Average Hot Water Mixes of Residential Plumbing Fixtures", June 2020, reports a value of 50.7°F for inlet water temperature for U.S. Census Division 3.

¹¹²⁹ U.S. Department of Energy. Return Condensate to the Boiler. https://www.energy.gov/sites/prod/files/2014/05/f16/steam8_boiler.pdf

%proposed	= Percentage of proposed condensate recovery = 80% ¹¹³⁰ or actual if known
n _{boiler}	= Efficiency of the steam or hot water boiler = Actual or if unknown use default values given below: = 81.9% for water boilers ¹¹³¹ = 80.7% for steam boilers, except multifamily low-pressure ¹¹³² = 64.8% for multifamily low-pressure steam boilers ¹¹³³
100,000	= Btu to therms for natural gas conversion factor. For other fossil-fuel, find appropriate conversion.

For example, for a Chicago 1,500 kbtu/hr steam boiler in an elementary school operating at 5 psi with a failed condensate return system.

$$\Delta\text{Therms} = ((1,603 * 1,500,000 * (193 - 18.8) * (1 - 0.12)) / ((193 - 18.8) * 0 + (1,155 - 18.8) * 0.8)) * ((0.8 - 0) / 1) * (1 / (0.807 * 100,000))$$

$$= 3,216 \text{ therms.}$$

WATER AND OTHER NON-ENERGY IMPACT DESCRIPTIONS AND CALCULATION

The methodology for calculating water savings involves obtaining the gallons of water that is dumped into the drain. Refer to fossil-fuel savings for calculation.

DEEMED O&M COST ADJUSTMENT CALCULATION

Maintenance personnel should complete annual or semi-annual maintenance inspections of the condensate return system for its optimal performance. The O&M cost shall be included in cost-effectiveness calculations. It is recommended to service the following components to maintain the system’s proper operation: pumps, ensure periodic lubrication for motors, in accordance with the motor manufacturer’s guidelines. Strainers, traps should also be included as an O&M consideration. A custom calculation should be used as necessary.

MEASURE CODE: CI-HVC-CNDR-V02-250101

REVIEW DEADLINE: 1/1/2026

¹¹³⁰ Okbaendrias, Biniam. Energy Management in Industries: Analysis of energy savings potential by steam condensate return. Page 10. About 75-85% of the total condensate return in reasonable.

¹¹³¹ Average efficiencies of units from the California Energy Commission (CEC).

¹¹³² Ibid.

¹¹³³ Katrakis, J. and T.S. Zawacki. “Field-Measured Seasonal Efficiency of Intermediate-sized Low-Pressure Steam Boilers”. ASHRAE V99, pt. 2, 1993.

4.4.58 Steam Trap Monitoring System

DESCRIPTION

The measure applies to the installation of a steam trap monitoring system. The measure is applicable to commercial applications, commercial HVAC including multifamily buildings, and industrial applications. An existing measure, 4.4.16 Steam Trap Replacement or Repair, covers the replacement of a faulty steam trap in the failed open or leaking state. In addition to the steam trap replacement savings, the proposed measure allows to account for savings due to faster repair of the steam traps. Once a failed steam trap is detected, it can be immediately repaired/replaced. Continuous steam trap monitoring leaves behind manual inspections (audits) by using sensors to transmit real-time conditions of the steam system.

Energy savings for each steam trap occurs only when failed open, and steam trap failure rates vary based on trap size, type, and pressure. Energy savings are calculated on a per trap basis with the assumed annual failure rate for each application. Separate savings methodologies are recommended for space heating and process heating applications.

This measure was developed to be applicable to the following program types: TOS, RF. If applied to other program types, the measure savings should be verified.

DEFINITION OF EFFICIENT EQUIPMENT

Customers must install a steam trap monitoring system on properly functioning steam traps serving either space heating or process heating load. The monitoring system must be capable of tracking the following, but not limited to, number of steam traps, trap type, operating pressure, operating temperature, ambient temperature, trap condition, date/time, application, and trap location. Applicants must provide characteristics for the steam system such as heating efficiency, steam trap orifice size(s), and system pressure(s). Customer must commit to repairing/replacing steam traps identified as failed by the steam trap monitoring system.

DEFINITION OF BASELINE EQUIPMENT

The baseline criterion are functioning steam traps serving either space heating or process heating load with no pre-existing monitoring system. No minimum leak rate is required.

DEEMED LIFETIME OF EFFICIENT EQUIPMENT

10 years based on vendor estimates.¹¹³⁴

DEEMED MEASURE COST

The costs are subject to the subscription period chosen by the customer as shown in table below. The approximate installed cost is per trap per year and includes sensors, gateway, cellular service, cloud hosting, User license, data, and reports.

Number of Traps	Term ¹¹³⁵				
	1 Year	2 Years	3 Years	4 Years	5 Years
100 – 250	\$300	\$282	\$265	\$249	\$234
250 – 499	\$291	\$274	\$257	\$242	\$227
500 – 999	\$282	\$265	\$249	\$234	\$220
1000 – 1999	\$274	\$257	\$242	\$227	\$214
2000 – 2999	\$266	\$250	\$235	\$221	\$207
3000 – 4999	\$262	\$246	\$232	\$218	\$204
5000 – 5999	\$258	\$242	\$228	\$214	\$201
6000 – 6999	\$254	\$238	\$224	\$210	\$198

¹¹³⁴ Measure life as referenced in Michigan CI Technologies & Franklin Energy “Work paper FES-H8a – Steam Trap Monitoring System” dated September 2016.

¹¹³⁵ The Everactive Steam Trap Monitoring Service Price

Number of Traps	Term ¹¹³⁵				
	1 Year	2 Years	3 Years	4 Years	5 Years
7000+	\$251	\$235	\$221	\$207	\$196

Additional costs exist for the repair or replacement of steam traps once identifying a fault.

LOADSHAPE

N/A

COINCIDENCE FACTOR

N/A

Algorithm

CALCULATION OF ENERGY SAVINGS

ELECTRIC ENERGY SAVINGS

Secondary kWh Savings for Water Supply and Wastewater Treatment

The following savings should be included in the total savings for this measure but should not be included in TRC tests to avoid double counting the economic benefit of water savings. These savings only apply to situations in which steam is lost from the steam system.

$$\Delta kWh_{water} = \Delta Water (gallons) / 1,000,000 \times E_{water\ supply}$$

Where

$$E_{water\ supply} = \text{Water Supply Energy Factor (kWh/Million Gallons)} \\ = 2571^{1136}$$

SUMMER COINCIDENT PEAK DEMAND SAVINGS

N/A

FOSSIL FUEL SAVINGS

$$\Delta Therm = N \times P_{malfunctioning} \times F_o \times S_a \times \left(\frac{(Hv + Hs \times (T_1 - T_{source})) \times Hours}{(100,000 \times \eta_B)} \right)$$

Where:

N = Total number of steam traps monitored through the steam trap monitoring system

P_{malfunctioning} = Annual Percentage of malfunctioning traps

$$P_{malfunctioning} = L \times T_{audit} \times T_u$$

Where:

L = Leaking & Blow-thru
= custom, if unknown:

¹¹³⁶ This factor includes 2571 kWh/MG for water supply based on Illinois energy intensity data from a 2012 ISAWWA study. For more information please review Elevate Energy’s ‘IL TRM: Energy per Gallon Factor, May 2018 paper’. Note since the water loss associated with this measure is due to evaporation and does not discharge into the wastewater system, only the water supply factor is used here.

Steam System	L (%) ¹¹³⁷
Commercial Dry Cleaners	27%
Commercial Heating (including Multifamily) LPS	27%
Industrial and Process Low Pressure ≤ 15 psig	16%
Medium Pressure > 15 psig < 30 psig	16%
Medium Pressure ≥ 30 < 75 psig	16%
High Pressure ≥ 75 < 125 psig	16%
High Pressure ≥ 125 < 175 psig	16%
High Pressure ≥ 175 < 250 psig	16%
High Pressure ≥ 300 psig	16%

T_{audit} = Average time between audits

Custom, if unknown use 1 year

T_u = Average percentage of year trap malfunctions are undetected for steam systems without a steam trap monitoring system

Custom, if unknown use 50%¹¹³⁸

F_o = Failed open to total failed ratio

= Custom, if unknown:

96%, Space heating applications¹¹³⁹

98%, Dry cleaners³

94%, All other steam systems and applications³

S_a = Steam loss per leaking trap, (lbs/hr)

H_v = Heat of vaporization of steam, (Btu/lbm)

Steam System	Average Inlet Pressure psig	Heat of Vaporization (Btu/lbm) ¹¹⁴⁰
Commercial Dry Cleaners	--	890
Commercial Space Heating (including Multifamily) LPS	11.2 ¹¹⁴¹	951
Industrial/Process Low Pressure: psig < 15	11.2 ⁹	951
Medium Pressure: 15 ≤ psig < 30	16	944
Medium Pressure: 30 ≤ psig < 75	47	915
High Pressure: 75 ≤ psig < 125	101	880

¹¹³⁷ Dry cleaners survey data as referenced in CLEAResult “Work Paper Steam Traps Revision #2” Revision 3 dated March 2, 2012.

¹¹³⁸ The energy savings estimates of this measure assume that without an automatic steam trap monitoring system, manual audits would be performed once per year, so a leaking steam trap would, on average, leak for 6 months before being detected and repaired/replaced when the trap fails

¹¹³⁹ Results from Steam Trap Audit/Replacement efficiency improvement research through the C&I and public Sector Prescriptive Rebate Program, Small Business Program and the Multi-family program. The evaluation included project and population data from years 2019 through 2022

¹¹⁴⁰ Heat of vaporization of steam at the inlet pressure to the steam trap. Implicit assumption that the average boiler nominal pressure where the vaporization occurs, is essentially that same pressure. Referenced in CLEAResult “Work Paper Steam Traps Revision #2” Revision 3 dated March 2, 2012.

¹¹⁴¹ Results from Armstrong International research through the steam trap management platform SAGE. The research population data included Commercial Heating LPS as well as Industrial or Process Low Pressure, < 15 psi applications. The search of the database yield 120,853 steam traps meeting these parameters: Average orifice size 0.21” and average pressure 11.2 psi.

Steam System	Average Inlet Pressure psig	Heat of Vaporization (Btu/lbm) ¹¹⁴⁰
High Pressure: 125 ≤ psig < 175	146	859
High Pressure: 175 ≤ psig < 250	202	837
High Pressure: 250 ≤ psig < 300	263	816
High Pressure: 300 ≤ psig	--	Custom

Hs = Specific heat of water, (Btu/(lbm * °R))
= 1.001

T₁ = Temperature of Saturated Steam, (°R)
= 507.89 × P₁^{0.0962}

Where:

= 507.89 = Constant, °R × (in²/lb_f)^{0.0962}

T_{source} = 513.67 °R¹¹⁴²

Hours = Annual hours when steam system is pressurized
= custom, if unknown:

Steam System	Zone (Where applicable)	Hours/Yr ¹¹⁴³
Commercial Dry Cleaners	All Climate Zones	2,425
Industrial/Process Low Pressure: psig < 15		8,282
Medium Pressure: 15 ≤ psig < 30		8,282
Medium Pressure: 30 ≤ psig < 75		8,282
High Pressure: 75 ≤ psig < 125		8,282
High Pressure: 125 ≤ psig < 175		8,282
High Pressure: 175 ≤ psig < 250		8,282
High Pressure: 250 ≤ psig < 300		8,282
High Pressure: 300 ≤ psig		8,282
Commercial Space Heating LPS	Rockford	4,272
	Chicago	4,029
	Springfield	3,406
	Belleville	2,515
	Marion	2,546
Multifamily Space Heating LPS	For steam traps that are part of steam systems where the boiler cycles on/off to maintain space setpoint temperature or for steam traps located downstream of a steam control valve that opens/closes to maintain setpoint temperature, use Heating EFLH values in Section 4.4 for High Rise or Mid-Rise MF buildings. For steam traps that are exposed to steam continuously throughout the heating season, use	

¹¹⁴² US DOE Building America Program. Building America Analysis Spreadsheet. For Chicago, IL.

¹¹⁴³ Medium and high-pressure steam trap annual operating hours based on Navigant analysis of source collected during program implementation by Nicor Gas for GPY1 through GPY4. For each steam trap project, the data provided measure savings description, operating pressure, installation Zip code, business building type, program year, and annual operating hours.

Steam System	Zone (Where applicable)	Hours/Yr ¹¹⁴³
	the values listed above for Commercial Space Heating LPS for your appropriate climate zone.	

- 100,000 = Conversion factor (*Btu/Therms*)
- η_B = Boiler efficiency
- = custom, if unknown:
 - 80.7% for steam boilers, except multifamily low-pressure¹¹⁴⁴
 - 64.8% for multifamily low-pressure steam boilers¹¹⁴⁵

Space Heating Savings Estimates

For systems used in space heating applications that operate at 5 psig or lower, use the following equation to calculate S_a ¹¹⁴⁶. The condensate return system pressure, P_2 , will typically be atmospheric pressure, 14.696 psia.

$$S_a = 1,519.3 \times P_1 \times D^2 \times \left[\left(\frac{1}{T_1} \right) \times \left(\frac{\gamma}{\gamma - 1} \right) \times \left(\left(\frac{P_2}{P_1} \right)^{(2/\gamma)} - \left(\frac{P_2}{P_1} \right)^{((\gamma+1)/\gamma)} \right) \right]^{0.5} \times A \times FF$$

Where:

- 1,519.3 = Constant, $(s^2 \times R^{0.5}) / (ft \times hr)$
- P_1 = Average steam trap inlet pressure (*absolute, psia*). If not available, use defaults provided in table below (note that defaults are provided in psig, not psia)
- D = Diameter of orifice, inches. Actual value should be used wherever possible as this value has a significant impact on steam flowrate value.
- γ = Heat Capacity Ratio (*unitless*)
 - = $5.071 \times 10^{-4} \times P_1 + 1.332$
- P_2 = Average steam trap outlet pressure (*absolute, psia*). If unknown, assume atmospheric pressure, 14.696 psia
- A = Adjustment factor
 - = 50%,¹¹⁴⁷ all steam systems. This factor accounts for reduction in the maximum theoretical steam flow to the average steam flow (the Enbridge factor).
- FF = Flow factor. In addition to the Adjustment factor (A), and additional 50% flow factor adjustment is recommended for medium and high-pressure steam systems to address industrial float and thermostatic style traps where additional blockage is possible.

Defaults are provided in table below if custom calculation is not performed. The savings are averages for common orifice diameters ($1/8, 3/16, 1/4, 5/16$ inches) at an assumed 5 psig.

¹¹⁴⁴ US DOE Building America Program. Building America Analysis Spreadsheet. For Chicago, IL.
¹¹⁴⁵ Katrakis, J. and T.S. Zawacki. "Field-Measured Seasonal Efficiency of Intermediate-sized Low-Pressure Steam Boilers". ASHRAE V99, pt. 2, 1993.
¹¹⁴⁶ See "Derivation of Equation for Subsonic Compressible Flow through an Orifice and Supporting Calculations for Illinois TRM Steam Trap Measure" paper for more information
¹¹⁴⁷ Enbridge adjustment factor used as referenced in CLEAResult "Work paper Steam Traps Revision #2" Revision 3 dated March 2, 2012 and DOE Federal Energy Management Program Steam Trap Replacement Assessment.

Savings per Steam Trap Orifice Size ¹¹⁴⁸		1/8	3/16	1/4	5/16
S _a	(lbs/hr)	3.84	8.64	15.35	23.99
ΔTherms	(Therms/trap/yr)	14.23	32.02	56.92	88.94

Process Heating Savings Estimates

Use the following equation, for all other steam systems and applications

$$S_a = 24.24 \times P_1 \times D^2 \times A \times FF$$

Where:

$$24.24 = \text{Constant, } lbm/(hr \times psia \times in^2)$$

Defaults are provided in table below if custom calculation is not performed.

Steam System	Average Steam Trap Inlet Pressure (psig) ¹¹⁴⁹	Diameter of Orifice (in)	Adjustment Factor	Flow Factor	S _a ¹¹⁵⁰ (lbs/trap/hr)	ΔTherm
Commercial Dry Cleaners	82.8	0.1250	50%	100%	18.5	65
Commercial LPS Space Heating	11.2	0.2100	50%	100%	13.8	101
Industrial/Process Low Pressure: psig < 15	11.2 ¹¹⁵¹	0.2100 ¹⁹	50%	100%	13.8	101
Medium Pressure: 15 ≤ psig < 30	16	0.1875	50%	50%	6.5	84
Medium Pressure: 30 ≤ psig < 75	47	0.2500	50%	50%	23.4	164
High Pressure: 75 ≤ psig < 125	101	0.2500	50%	50%	43.8	296
High Pressure: 125 ≤ psig < 175	146	0.2500	50%	50%	60.7	401
High Pressure: 175 ≤ psig < 250	202	0.2500	50%	50%	82.1	527
High Pressure: 250 ≤ psig < 300	263	0.2500	50%	50%	105.2	658

WATER AND OTHER NON-ENERGY IMPACT DESCRIPTIONS AND CALCULATION

The hourly water volume saved per each repaired or replaced leaking trap is calculated by dividing the “Steam Loss per Leaking Trap (lbm/hr/trap)” by the density of water saved, 8.33 lbm/gal, that replaces the lost steam. The steam loss is provided in the table for parameter S_a, the “Steam loss per leaking trap” in the Fossil Fuel savings section

¹¹⁴⁸ Default values are directly calculated using the equations above.

¹¹⁴⁹ Medium and high-pressure steam trap inlet pressure based on Navigant analysis of source collected during program implementation by Nicor Gas for GPY1 through GPY4. For each steam trap project, the data provided measure savings description, operating pressure, installation Zip code, business building type, program year, and annual operating hours. Dry cleaning steam trap inlet pressure based on C5 Steam Traps – Nicor FINAL 10.27.11.

¹¹⁵⁰ Default values are directly calculated using the equations above.

¹¹⁵¹ Results from Armstrong International research through the steam trap management platform SAGE. The research population data included Commercial Heating LPS as well as Industrial or Process Low Pressure, < 15 psi applications. The search of the database yields 120,853 steam traps meeting these parameters: Average orifice size 0.21” and average pressure 11.2 psi.

above. Annual water savings are calculated using Hours and $P_{malfunctioning}$, the annual percentage of malfunctioning traps, as defined above.

Water savings only apply to situations where condensate is lost from the steam system. If a condensate recovery system is in place, assume zero water savings or provide a custom calculation based on site-specific operation.

The annual water savings for a replaced or repaired trap is given by:

$$\Delta Water = GAL \times Hours \times N \times P_{malfunctioning} \times F_o$$

Where:

GAL = average actual water volume saved per leaking trap, as listed in the following table and based on steam system type.

Other variables as defined above

Steam System	S_a	GAL (gal/hr/trap)
Commercial Dry Cleaners	18.5	2.22
Multifamily LPS Space Heating	6.9	0.83
Industrial/Process Low Pressure: psig < 15	13.8	1.66
Medium Pressure: 15 ≤ psig < 30	6.5	0.79
Medium Pressure: 30 ≤ psig < 75	23.4	2.81
High Pressure: 75 ≤ psig < 125	43.8	5.26
High Pressure: 125 ≤ psig < 175	60.9	7.31
High Pressure: 175 ≤ psig < 250	82.1	9.85
High Pressure: 250 ≤ psig < 300	105.2	12.63
High Pressure: 300 ≤ psig	Calculated	Calculated Steam Loss / 8.33

DEEMED O&M COST ADJUSTMENT CALCULATION

N/A

MEASURE CODE: CI-HVC-STMS-V1-230101

REVIEW DEADLINE: 1/1/2025

4.4.59 Ductless Heat Pumps - Removed in v.13

Measure now combined with 4.4.9 Air and Water Source Heat Pump System (Centrally Ducted and Ductless)

4.4.60 Variable Refrigerant Flow HVAC System

DESCRIPTION

This measure applies to the installation of air source Variable Refrigerant Flow (VRF) HVAC systems. VRF systems are heat pumps that have one outdoor condensing unit with refrigerant piped to multiple indoor evaporator units to deliver cooling and/or heating to individual interior zones as needed. This measure could apply to replacing an existing unit at the end of its useful life or the installation of a new unit in a new or existing building.

This measure was developed to be applicable to the following program times: TOS and NC. If applied to other program types, the measure savings should be verified.

DEFINITION OF EFFICIENT EQUIPMENT

This measure applies to both retrofit and new construction installations of VRF systems. Savings are based in the inherent efficiency of VRF systems as compared to traditional HVAC systems. VRF systems should meet or exceed ASHRAE 90.1 minimum efficiency requirements for air source VRF systems.

DEFINITION OF BASELINE EQUIPMENT

Time of Sale / New Construction

Non-fuel switch measures:

To calculate savings with an electric baseline, the baseline equipment is assumed to be a ducted split-system heat pump for non-residential buildings 25,000 square feet or fewer and is 3 floors or fewer. For non-residential buildings over 25,000 square feet or 4 floors or higher, the baseline equipment is assumed to be a standard-efficiency air cooled heat pump roof top unit (RTU) system. For residential buildings types which utilize individual in-unit HVAC systems, such as multifamily, lodging, dormitories, etc., the baseline equipment is assumed to be a residential style standard-efficiency packaged terminal heat pump split system.

Fuel switch measures:

To calculate savings with a gas or fuel heating baseline, the baseline equipment is assumed to be single zone furnace and air-conditioning units for non-residential buildings 25,000 square feet or fewer and is 3 floors or fewer. For non-residential buildings over 25,000 square feet or taller than 3 floors, the baseline equipment is assumed to be a packaged variable-air-volume (VAV) system with DX cooling and hot water reheat. For residential buildings types which utilize individual in-unit HVAC systems, such as multifamily, lodging, dormitories, etc., the baseline equipment is assumed to be a packaged terminal air conditioner (PTAC) with hot-water radiator heating. If the residential building is 4 stories or more, the baseline system will be a water source heat pump (WSHP) system with a boiler and cooling tower.

Standard efficiency implies equipment that complies with Code energy efficiency requirements (IECC or Code of Federal Regulations, whichever is higher) in effect on the date of equipment purchase (if date unknown, assume current Code minimum). The rating conditions for the baseline and efficient equipment efficiencies must be equivalent. Note: IECC 2018 is baseline for all New Construction permits from July 1, 2019, and if permit date unknown. Note: new Federal Standards affecting heat pumps become effective January 1, 2023.

Baseline selection:

The following table can be used to determine the appropriate baseline HVAC system type.

	Non-Fuel Switch	Fuel Switch
Multifamily or Lodging, 3 floors or fewer	Packaged Terminal Heat Pump	PTAC w/ Hot Water Radiator
Multifamily or Lodging, 4 floors or more	Packaged Terminal Heat Pump	Water Source Heat Pump with Cooling Tower and Natural Gas Boiler

	Non-Fuel Switch	Fuel Switch
Non-residential <25,000 SF and 3 floors or fewer	Ducted-Split System Heat Pump	Packaged Single Zone (Furnace) + Air Conditioner
Non-Residential >25,000 SF OR more than 3 floors	Heat Pump RTU	Packaged VAV RTU with Hot Water Reheat

DEEMED LIFETIME OF EFFICIENT EQUIPMENT

The expected measure life for VRF is 16 years¹¹⁵².

DEEMED MEASURE COST

Time of Sale: For analysis, the incremental capital costs are summarized in the following table. Site specific cost data should be used where available.

Baseline System	Incremental Cost (\$/ton) ¹¹⁵³
Packaged Terminal Heat Pump	\$610
Ducted Split System Heat Pump	\$860
Heat Pump RTU	\$130
PTAC w/ Hot Water Radiator	\$160
Water Source Heat Pump	\$0
Packaged Single Zone (Furnace) + Air Conditioner	\$835
Packaged VAV RTU with Hot Water Reheat	\$540

LOADSHAPE

Loadshape C05 – Commercial Electric Heating and Cooling

COINCIDENCE FACTOR

The summer peak coincidence factor for cooling is provided in two different ways below. The first is used to estimate peak savings during the utility peak hour and is most indicative of actual peak benefits. The second represents the *average* savings over the defined summer peak period and is presented so that savings can be bid into PJM’s capacity market. Both values provided are based on analysis of Itron eShape data for Missouri, calibrated to Illinois loads, supplied by Ameren.

CF_{SSP} = Summer System Peak Coincidence Factor for Commercial cooling (during system peak hour)
 = 91.3%¹¹⁵⁴

¹¹⁵² Consistent with Residential air source heat pump measure and based on a 2016 DOE Rulemaking Technical Support document, as recommended in Guidehouse ‘ComEd Effective Useful Life Research Report’, May 2018.

¹¹⁵³ Estimated measure incremental costs for PTHP, HP RTU and PTAC based other incremental costs and differences in installed cost from U.S. Energy Information Administration (EIA), Updated Buildings Sector Appliance and Equipment Costs and Efficiencies: <https://www.eia.gov/analysis/studies/buildings/equipcosts/pdf/full.pdf>. For Ducted Split HP, Packaged Single Zone Furnace + AC and Packaged VAV RTU is based on Mid-Atlantic Technical Reference Manual version 9, Variable Refrigerant Flow (VRF) Heat Pump Systems measure. Published October, 2019. Water-source HP systems estimated from data collected from manufacturers. Water-source heat pump systems were not very different compared to VRF systems.

¹¹⁵⁴ Based on analysis of Itron eShape data for Missouri, calibrated to Illinois loads, supplied by Ameren. The AC load during the utility’s peak hour is divided by the maximum AC load during the year.

$$CF_{PJM} = \text{PJM Summer Peak Coincidence Factor for Commercial cooling (average during peak period)}$$

$$= 47.8\%^{1155}$$

Algorithm

CALCULATION OF ENERGY SAVINGS

ELECTRIC ENERGY SAVINGS

Savings are calculated as a sum of system switching savings and efficiency savings, analogous to the following equation:

$$\text{Annual Savings} = [\text{System Switch Savings}] + [\text{Savings from improved VRF efficiency}]$$

For fuel-switching calculations, the above equation is used for calculating the cooling savings, while the heating savings are calculated by as the following:

$$\text{Annual Savings} = [\text{Gas Heat Replaced} \times \text{System Switch Adjustment Factor}] + [\text{Fan Savings}] - [\text{Heat Pump heat consumed} \times \text{System Switch Adjustment Factor}] + [\text{Heat Pump Cooling} \times \text{System Switch Savings} + \text{Heat Pump Cooling Savings from improved VRF efficiency}]$$

The system switching savings are calculated by multiplying the cooling or heating load (EFLH times heat or cool capacity) and multiplying it by system heating (Heat_{adj}) and cooling (Cool_{adj}) factors. These adjustment factors were calculated with energy model data of different building types. The VRF performance curves were calibrated based on independent field monitored data.

- The difference in building code baseline efficiency between VRF and the baseline system.
- The improved part load performance of the VRF inverter driven compressor compared to single-stage or two-stage compressors.
- Heat recovery mode savings from the VRF units.
- Decrease in energy from cooling towers (WSHP baseline) and water pumps (baseline systems with hot water and WSHP).
- WSHP electric heating and boiler fuel consumption (WSHP baseline).
- Differences in treating ventilation between mixed recirculating systems and VRF systems with dedicated outdoor air systems (Heat Pump RTU and VAV baseline systems only).

Savings from improved VRF efficiency is similar to other efficiency savings from other TRM measures, where savings are calculated as the load multiplied by the change in efficiency.

Non-fuel switch measures:

For units with cooling capacities less than 65 kBtu/hr:

$$\Delta kWh = \text{Annual kWh Savings}_{\text{Cool}} + \text{Annual kWh Savings}_{\text{Heat}} + \text{FanSavings}$$

$$\text{Annual kWh Savings}_{\text{Cool}} = [\text{System Switch Savings}] + [\text{Savings from improved VRF efficiency}]$$

$$= (\text{Cool}_{\text{adj}} * \text{Capacity}_{\text{cool}} * \text{EFLH}_{\text{cool}}/3,412) + (\text{Capacity}_{\text{cool}} * \text{EFLH}_{\text{cool}} * (1/\text{SEER}_{\text{base}} - 1/\text{SEER}_{\text{ee}}))/1000$$

$$\text{Annual kWh Savings}_{\text{Heat}} = [\text{System Switch Savings}] + [\text{Savings from improved VRF efficiency}]$$

$$= (\text{Heat}_{\text{adj}} * \text{HeatLoad}/3,412) + (\text{HeatLoad} * (1/\text{HSPF}_{\text{base}} - 1/\text{HSPF}_{\text{ee}}))/1000$$

$$\text{FanSavings} = (\text{Flag} * \text{HeatLoad} * 1/\text{AFUE}_{\text{base}} * F_e) / 3,412$$

¹¹⁵⁵ Based on analysis of Itron eShape data for Missouri, calibrated to Illinois loads, supplied by Ameren. The average AC load over the PJM peak period (1-5pm, M-F, June through August) is divided by the maximum AC load during the year.

For units with cooling capacities equal to or greater than 65 kBtu/hr:

$$\begin{aligned} \Delta kWh &= \text{Annual kWh Savings}_{\text{cool}} + \text{Annual kWh Savings}_{\text{heat}} + \text{FanSavings} \\ \text{Annual kWh Savings}_{\text{cool}} &= [\text{System Switch Savings}] + [\text{Savings from improved VRF efficiency}] \\ &= (\text{Cool}_{\text{adj}} * \text{Capacity}_{\text{cool}} * \text{EFLH}_{\text{cool}}/3,412) + (\text{Capacity}_{\text{cool}} * \text{EFLH}_{\text{cool}} * (1/\text{EER}_{\text{base}} - 1/\text{EER}_{\text{ee}}))/1000 \\ \text{Annual kWh Savings}_{\text{heat}} &= [\text{System Switch Savings}] + [\text{Savings from improved VRF efficiency}] \\ &= (\text{Heat}_{\text{adj}} * \text{HeatLoad})/3,412 + (\text{HeatLoad} * (1/\text{COP}_{\text{base}} - 1/\text{COP}_{\text{ee}})) / 3,412 \\ \text{FanSavings} &= (\text{Flag} * \text{HeatLoad} * 1/\text{AFUE}_{\text{base}} * F_e) / 3,412 \end{aligned}$$

Fuel switch measures:

Fuel switch measures must produce positive total lifecycle site energy savings in order to qualify. This is determined as follows (note for early replacement measures the lifetime savings should be calculated by calculating savings for the remaining useful life of the existing equipment and for the remaining measure life):

$$\begin{aligned} \text{SiteEnergySavings (MMBTU)} &= \text{GasHeatReplaced} + \text{FanSavings} - \text{HPSiteHeatConsumed} + \text{HPSiteCoolingImpact} \\ \text{GasHeatReplaced (MMBTU)} &= (\text{GasHeat}_{\text{adj}} * \text{HeatLoad} * 1/\text{AFUE}_{\text{base}}) / 1,000,000 \\ \text{FanSavings (MMBTU)} &= (\text{Flag} * \text{HeatLoad} * 1/\text{AFUE}_{\text{base}} * F_e) / 1,000,000 \end{aligned}$$

For units with cooling capacities less than 65 kBtu/hr:

$$\begin{aligned} \text{HPSiteHeatConsumed (MMBTU)} &= (\text{Heat}_{\text{adj}} * \text{HeatLoad} * (1/\text{HSPFee})) * 3,412 / 1,000 / 1,000,000 \\ \text{HPSiteCoolingImpact (MMBTU)} &= [\text{System Switch Savings}] + [\text{Savings from improved VRF efficiency}] \\ &= ((\text{Cool}_{\text{adj}} * \text{Capacity}_{\text{cool}} * \text{EFLH}_{\text{cool}}) / 1,000,000) + ((\text{EFLH}_{\text{cool}} * \text{Capacity}_{\text{cool}} * (1/\text{SEER}_{\text{base}} - 1/\text{SEER}_{\text{ee}})) * 3,412 / 1,000 / 1,000,000) \end{aligned}$$

For units with cooling capacities greater than 65 kBtu/hr:

$$\begin{aligned} \text{HPSiteHeatConsumed (MMBTU)} &= (\text{Heat}_{\text{adj}} * \text{HeatLoad} * (1/\text{COP}_{\text{ee}})) / 1,000,000 \\ \text{HPSiteCoolingImpact (MMBTU)} &= [\text{System Switch Savings}] + [\text{Savings from improved VRF efficiency}] \\ &= ((\text{Cool}_{\text{adj}} * \text{Capacity}_{\text{cool}} * \text{EFLH}_{\text{cool}}) / 1,000,000) + ((\text{EFLH}_{\text{cool}} * \text{Capacity}_{\text{cool}} * (1/\text{EER}_{\text{base}} - 1/\text{EER}_{\text{ee}})) * 3,412 / 1,000 / 1,000,000) \end{aligned}$$

Savings are adjusted by heating (Heat_{adj}) and cooling (Cool_{adj}) factors presented in the following table. These values bring the expected savings in line with energy model estimated savings.

Baseline System	GasHeat _{adj}	Cool _{adj}	Heat _{adj}
Packaged Terminal Heat Pump	N/A	0.1	0.0
Ducted Split System Heat Pump	N/A	0.0	0.0
Heat Pump RTU	N/A	-0.2	0.5
PTAC w/ Hot Water Radiator	0.7	0.0	1.3

Baseline System	GasHeat _{adj}	Cool _{adj}	Heat _{adj}
Water Source Heat Pump	0.4	0.1	0.5
Packaged Single Zone (Furnace) + Air Conditioner	1.4	0	1.6
Packaged VAV RTU with Hot Water Reheat	0.9	-0.2	1.8

If SiteEnergySavings calculated above is positive, the measure is eligible. The appropriate savings claim is dependent on which utilities are supporting the measure as provided in a table below:

Measure supported by:	Electric Utility claims (kWh):	Gas Utility claims (therms):
Electric utility only	SiteEnergySavings * 1,000,000/3,412	N/A
Electric and gas utility (Note: utilities may make alternative agreements to how savings are allocated as long as total MMBtu savings remains the same).	%IncentiveElectric * SiteEnergySavings * 1,000,000/3,412	%IncentiveGas * SiteEnergySavings * 10
Gas utility only	N/A	SiteEnergySavings * 10

Where:

- Cool_{adj} = This cooling adjustment factor is derived from energy modeling results to calibrate TRM calculation savings to energy modeling savings estimates.¹¹⁵⁶ Adjustment factor values are presented in a table above.
- Heat_{adj} = This heating adjustment factor is derived from energy modeling results to calibrate TRM calculation savings to energy modeling savings estimates.¹¹⁵⁷ Adjustment factor values are presented in a table above.
- GasHeat_{adj} = This gas heating adjustment factor is derived from energy modeling results to calibrate TRM calculation savings to energy modeling savings estimates.¹¹⁵⁸ Adjustment factor values are presented in a table above.
- Capacity_{cool} = input capacity of the cooling equipment in Btu per hour (1 ton of cooling capacity equals 12,000 Btu/hr).
= Actual installed
- SEER_{base} = Seasonal Energy Efficiency Ratio of the baseline equipment
= SEER from tables below, based on the applicable Code on the date of equipment purchase (if unknown assume current Code).
- SEER_{ee} = Seasonal Energy Efficiency Ratio of the energy efficient equipment.
= Actual installed
- EFLH_{cool} = Equivalent Full Load Hours for cooling in Existing Buildings or New Construction are provided in section 4.4 HVAC End Use.
- HSPF_{base} = Heating Seasonal Performance Factor of the baseline equipment
= HSPF from tables below, based on the applicable Code on the date of equipment purchase (if unknown assume current Code).

¹¹⁵⁶ Based on Variable Refrigerant Flow Study. See 'Variable Refrigerant Flow Study 2023'.

¹¹⁵⁷ Based on Variable Refrigerant Flow Study. See 'Variable Refrigerant Flow Study 2023'.

¹¹⁵⁸ Based on Variable Refrigerant Flow Study. See 'Variable Refrigerant Flow Study 2023'.

- HSPFee = Heating Seasonal Performance Factor of the energy efficient equipment.
 = Actual installed. If rating is COP, HSPF = COP * 3.413
- EERbase = Energy Efficiency Ratio of the baseline equipment
 = EER from tables below, based on the applicable Code on the date of equipment purchase (if unknown assume current Code). For air-cooled units < 65 kBtu/hr, assume the following conversion from SEER to EER for calculation of peak savings¹¹⁵⁹:

$$EER = (-0.02 * SEER_2) + (1.12 * SEER)$$
- EERee = Energy Efficiency Ratio of the energy efficient equipment. For air-cooled units < 65 kBtu/hr, if the actual EERee is unknown, assume the conversion from SEER to EER as provided above.
 = Actual installed
- HeatLoad = Calculated heat load for the building
 = $EFLH_{heat} * Capacity_{heat}$
 Where:
 $EFLH_{heat}$ = heating mode equivalent full load hours in Existing Buildings or New Construction are provided in section 4.4 HVAC End Use.
 $Capacity_{heat}$ = Actual installed input capacity of the heat pump equipment in Btu per hour.
- 3412 = Btu per kWh.
- COPbase = coefficient of performance of the baseline equipment
 = COP from tables below, based on the applicable Code on the date of equipment purchase (if unknown assume current Code).
 If rating is HSPF, COP = HSPF / 3.413
- COPEe = coefficient of performance of the energy efficient equipment.
 = Actual installed. If rating is HSPF, COP = HSPF / 3.413
- AFUEbase = Baseline Annual Fuel Utilization Efficiency Rating. Use appropriate code level efficiency.
- Flag = 1 if system replaced is an RTU or ducted system with furnace fan, 0 if not.
- Fe = Fan energy consumption as a percentage of annual fuel consumption
 = 7.7% for RTU replacement, 3% for multifamily (residential style) furnace replacement¹¹⁶⁰
- %IncentiveElectric = % of total incentive paid by electric utility
 = Actual
- %IncentiveGas = % of total incentive paid by gas utility
 = Actual

¹¹⁵⁹ Based on Wassmer, M. (2003). A Component-Based Model for Residential Air Conditioner and Heat Pump Energy Calculations. Masters Thesis, University of Colorado at Boulder. Note this is appropriate for single speed units only.

¹¹⁶⁰ Fe is estimated using TRM models for the three building types: low-rise office, sit-down restaurant and retail-strip mall. 7.7% represents the average Fe of the three building types. See "Fan Energy Factory Example Calculation 2021-06-23.xlsx" for reference. Mutlifamily is 3%, lower than commercial, due to typically lower fan static pressure in residential style applications.

Equipment Type	Size Category	Heating Section Type	Subcategory or Rating Condition	Minimum Efficiency	Test Procedure
VRF air cooled (cooling mode)	<65,000 Btu/h	All	VRF multisplit system	13.0 SEER	AHRI 1230
		≥65,000 Btu/h and <135,000 Btu/h	Electric resistance (or none)		
	VRF multisplit system with heat recovery			10.8 EER 12.7 IEER 14.4 IEER	
	VRF multisplit system			10.6 EER 12.3 IEER 13.9 IEER	
	VRF multisplit system with heat recovery			10.4 EER 12.1 IEER 13.7 IEER	
	≥135,000 Btu/h and <240,000 Btu/h	Electric resistance (or none)	VRF multisplit system	9.5 EER 11.0 IEER 12.7 IEER	
VRF multisplit system with heat recovery			9.3 EER 10.8 IEER 12.5 IEER		
VRF air cooled (heating mode)	<65,000 Btu/h (cooling capacity)		VRF multisplit system	7.7 HSPF	AHRI 1230
	≥65,000 Btu/h and <135,000 Btu/h (cooling capacity)	Electric resistance (or none)	VRF multisplit system 47°F db/43°F wb outdoor air	3.3 COP _H	
			VRF multisplit system 17°F db/15°F wb outdoor air	2.25 COP _H	
	≥135,000 Btu/h (cooling capacity)	Electric resistance (or none)	VRF multisplit system 47°F db/43°F wb outdoor air	3.2 COP _H	
			VRF multisplit system 17°F db/15°F wb outdoor air	2.05 COP _H	

Non Fuel Switch example, a heat recovery VRF system with 8 ton cooling capacity and 96 kbtu heating capacity, an efficient EER of 12.5 and COP of 3.75, at a new construction low-rise office in Chicago saves:

$$\Delta kWh = \text{Annual kWh Savings}_{\text{cool}} + \text{Annual kWh Savings}_{\text{heat}} + \text{FanSavings}$$

$$\text{Annual kWh Savings}_{\text{cool}} = (\text{Cooladj} * \text{Capacity}_{\text{cool}} * \text{EFLH}_{\text{cool}} / 3412) + (\text{Capacity}_{\text{cool}} * \text{EFLH}_{\text{cool}} * (1/\text{EER}_{\text{base}} - 1/\text{EER}_{\text{ee}}))/1000$$

$$\text{Annual kWh Savings}_{\text{heat}} = (\text{Heatadj} * \text{Heat Load} / 3412) + (\text{HeatLoad} * (1/\text{COP}_{\text{base}} - 1/(\text{COP}_{\text{ee}}))/3412$$

$$\text{FanSavings} = (\text{Flag} * \text{HeatLoad} * 1/\text{AFUE}_{\text{base}} * \text{Fe}) / 3412$$

$$\Delta kWh = (0.0 * 96000 * 989/3,412) + (96000 * 989 * (1/10.8 - 1/12.5))/1000 + (0.0 * 916 * 60000/3412) + (916 * 60000 * (1/3.3 - 1/3.75) / 3412) + (1 * 916 * 60000 * 1/0.8 * 0.077) / 3412$$

$$\Delta kWh = 3332 \text{ kWh}$$

Fuel Switch example, a heat recovery VRF system with 8-ton cooling capacity and 96 kbtu heating capacity, an efficient EER of 12.5 and COP of 3.75, at a new construction low-rise office in Chicago, assuming a packaged single zone (furnace) and air conditioner baseline. Assuming 50%-50% Incentive agreement is used for joint programs, savings:

$$\text{SiteEnergySavings (MMBTUs)} = \text{GasHeatReplaced} + \text{FanSavings} - \text{HPSiteHeatConsumed} + \text{HPSiteCoolingImpact}$$

$$\begin{aligned} \text{GasHeatReplaced} &= (\text{GasHeat}_{\text{adj}} * \text{HeatLoad} * 1/\text{AFUE}_{\text{base}}) / 1,000,000 \\ &= 1.4 * (96000 * 916 * 1/0.8) / 1000000 \\ &= 153.9 \text{ MMBtu} \end{aligned}$$

$$\begin{aligned} \text{FanSavings} &= (\text{Flag} * \text{HeatLoad} * 1/\text{AFUE}_{\text{base}} * F_e) / 1,000,000 \\ &= (1 * 96000 * 916 * 1/0.8 * 0.030) / 1000000 \\ &= 3.30 \text{ MMBtu} \end{aligned}$$

For units with cooling capacities greater than 65 kbtu/hr:

$$\begin{aligned} \text{HPSiteHeatConsumed} &= (\text{Heat}_{\text{adj}} * \text{HeatLoad} * (1/\text{COP}_{\text{ee}})) / 1,000,000 \\ &= (1.6 * 96000 * 916 * (1/3.75)) / 1,000,000 \\ &= 37.9 \text{ MMBtu} \end{aligned}$$

$$\begin{aligned} \text{HPSiteCoolingImpact} &= (\text{Cool}_{\text{adj}} * \text{Capacity}_{\text{cool}} * \text{EFLH}_{\text{cool}} / 1,000,000) * (\text{FLH}_{\text{cool}} * \text{Capacity}_{\text{cool}} * \\ &\quad (1/\text{EER}_{\text{base}} - 1/\text{EER}_{\text{ee}})) * 3,412 / 1,000 / 1,000,000 \\ &= ((0.0 * 989 * 96000)/1,000,000) + (989 * 96000 * (1/10.8 - 1/12.5)) * 3,412 \\ &\quad / 1,000 / 1,000,000 \\ &= 4.1 \text{ MMBtu} \end{aligned}$$

$$\text{SiteEnergySavings (MMBTUs)} = 153.9 + 3.30 - 37.9 + 4.1 = 123.3 \text{ [Measure is eligible]}$$

Savings would be claimed as follows, assuming a 50%-50% incentive agreement:

Measure supported by:	Electric Utility claims (kWh):	Gas Utility claims (therms):
Electric utility only	$123.3 * 1,000,000/3,412$ = 36,148 kWh	N/A
Electric and gas utility (Note utilities may make alternative agreements to how savings are allocated as long as total MMBtu savings remains the same).	$0.5 * 123.3 * 1,000,000/3,412$ = 18,074 kWh	$0.5 * 88.9 * 10$ = 617 therms
Gas utility only	N/A	$123.3 * 10$ = 1,233 therms

SUMMER COINCIDENT PEAK DEMAND SAVINGS

$$\Delta \text{kW} = (\text{Capacity}_{\text{cool}} / 1,000 * (1/\text{EER}_{\text{base}} - 1/\text{EER}_{\text{ee}})) * \text{CF}$$

Where CF value is chosen between:

$$\begin{aligned} \text{CF}_{\text{SSP}} &= \text{Summer System Peak Coincidence Factor for Commercial cooling (during system peak hour)} \\ &= 91.3\% \end{aligned}$$

$$CF_{PJM} = \text{PJM Summer Peak Coincidence Factor for Commercial cooling (average during peak period)}$$

$$= 47.8\%$$

For example, a heat recovery VRF system with 8-ton cooling capacity and 96 kbtu heating capacity, an efficient EER of 12.5, saves:

$$\Delta kW = (96,000/1,000 * (1/10.8 - 1/12.5)) * 0.913$$

$$= 1.1 \text{ kW}$$

FOSSIL FUEL SAVINGS

Calculation provided together with Electric Energy Savings above.

WATER AND OTHER NON-ENERGY IMPACT DESCRIPTIONS AND CALCULATION

N/A

DEEMED O&M COST ADJUSTMENT CALCULATION

N/A

COST EFFECTIVENESS SCREENING AND LOAD REDUCTION FORECASTING WHEN FUEL SWITCHING

This measure can involve fuel switching from gas to electric.

For the purposes of forecasting load reductions due to fuel switch ASHP projects per Section 16-111.5B, changes in site energy use at the customer’s meter (using ΔkWh algorithm below), customer switching estimates, NTG, and any other adjustment factors deemed appropriate, should be used.

The inputs to cost effectiveness screening should reflect the actual impacts on the electric and fuel consumption at the customer meter and, for fuel switching measures, should therefore reflect the decrease in one fuel and increase in another, as opposed to the single savings value calculated in the “Electric and Fossil Fuel Energy Savings” section above. Therefore in addition to the calculation of savings claimed, the following values should be used to assess the cost effectiveness of the measure.

$$\Delta \text{Therms} = [\text{Heating Consumption Replaced}]$$

$$= [\text{GasHeat}_{Adj} * \text{HeatLoad} * 1/\text{AFUE}_{base}] / 100,000]$$

$$\Delta \text{kWh} = [\text{FurnaceFanSavings}] - [\text{HP heating consumption}] + [\text{Cooling savings}]$$

For units with cooling capacities less than 65 kBtu/hr:

$$\Delta \text{kWh} = [\text{FurnaceFlag} * \text{HeatLoad} * 1/\text{AFUE}_{base} * F_e * 0.000293] - [\text{Heat}_{Adj} * \text{HeatLoad}/3412 * (1/(\text{CO}_{Pee}))]/1000] + [\text{Cool}_{adj} * (\text{Capacity}_{cool} * \text{EFLH}_{cool} * (1/\text{EER}_{base} - 1/\text{EER}_{ee}))/1000]$$

For units with cooling capacities greater than 65 kBtu/hr:

$$\Delta \text{kWh} = [\text{FurnaceFlag} * \text{HeatLoad} * 1/\text{AFUE}_{base} * F_e * 0.000293] - [\text{Heat}_{adj} * \text{HeatLoad}/3412 * (1/\text{CO}_{Pee})] + [\text{Cool}_{adj} * (\text{Capacity}_{cool} * \text{EFLH}_{cool} * (1/\text{EER}_{base} - 1/\text{EER}_{ee}))/1000]$$

MEASURE CODE: CI-HVC-VFFY-V3-240101

REVIEW DEADLINE: 1/1/2026

4.4.61 Chiller Condenser Water Temperature Reset

DESCRIPTION

Condenser water temperature reset – reset the constant condensing loop supply temperature from constant 80°F to a dynamic range of 70°F to 80°F based on the outdoor-air wet-bulb temperature (WBT). When the outdoor-air wet-bulb temperature is below 60°F, reset the condensing loop set point to 70°F. When the outdoor-air wet-bulb temperature is above 70°F, reset to 80°F; when the outdoor-air wet-bulb temperature is in between, reset the condensing supply temperature to 10°F higher than the outdoor-air wet-bulb temperature. The chiller COP (coefficient of performance) increases after the measure is applied. However, the condenser loop balances out the energy saving because the cooling tower fan works harder and longer to cool condensing water to a lower temperature. The resulting savings (primarily cooling) from this measure are roughly proportional to the amount of part-load cooling that is required in the baseline and range between 0.1% and 1.3%.

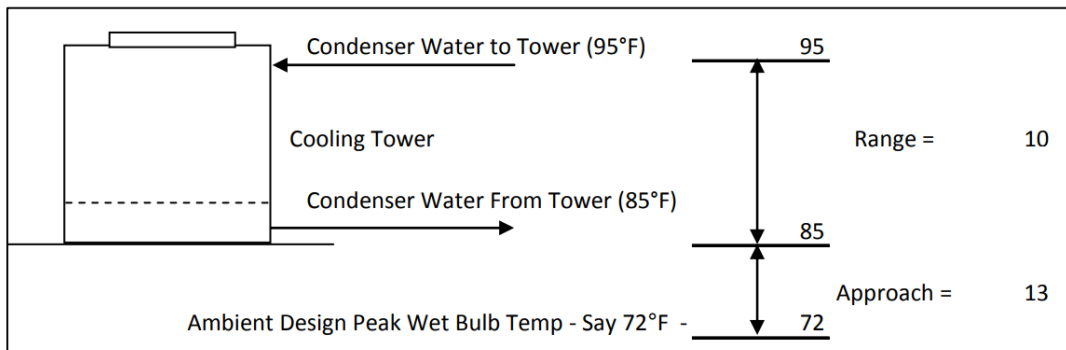

DEFINITION OF EFFICIENT EQUIPMENT

This measure is applicable when the condenser water temperature (CWT) setpoint is either not resetting properly, or a reset strategy is not implemented. The minimum setpoint is set to 70°F.

DEFINITION OF BASELINE EQUIPMENT

The baseline condition is fixed condenser water temperature of 85°F. Only applicable to water-cooled chillers.

Baseline Data Collection:

- Trend Current outdoor air dry bulb and wet bulb temperatures
- Trend Current entering condenser water supply temperature
- Trend Current leaving chilled water temperature

DEEMED LIFETIME OF EFFICIENT EQUIPMENT

The expected lifetime of the measure is 10 years¹¹⁶¹

DEEMED MEASURE COST

Use actual chiller manufacturer provided cost.

LOADSHAPE

Loadshape C03 - Commercial Cooling

COINCIDENCE FACTOR

CF_{SSP} = Summer System Peak Coincidence Factor for Commercial cooling (during system peak hour)

¹¹⁶¹ 2008 Database for Energy-Efficiency Resources (DEER), Version 2008.2.05, "Effective/Remaining Useful Life Values", California Public Utilities Commission, December 16, 2008

$$= 91.3\%^{1162}$$

CF_{PJM} = PJM Summer Peak Coincidence Factor for Commercial cooling (average during peak period)

$$= 47.8\%^{1163}$$

Algorithm

CALCULATION OF ENERGY SAVINGS

Efficient Data Collection:

- 1 Trend outdoor air dry bulb and wet bulb temperatures
- 2 Trend entering condenser water supply temperature
- 3 Trend leaving chilled water temperature
- 4 Trend energy usage (kWh)
- 5 Model weather bin data
- 6 Trend condenser water supply temperature and temperature setpoint, and whatever parameter the reset is based on (e.g., outside air dry bulb and wet bulb temperatures).
- 7 Perform functional testing if independent variables at the time of trending do not cover the range covered by the reset.

ELECTRIC ENERGY SAVINGS

$$\Delta kWh = TONS * ((IPLV_{base}) - (CPLV_{ee})) * EFLH$$

Where:

TONS	= Chiller nominal cooling capacity in tons (note: 1 ton = 12,000 Btu/hr) = Actual installed
$IPLV_{base}$	= Efficiency of baseline equipment expressed as Integrated Part Load Value(kW/ton). Chiller units are dependent on chiller type. See Chiller Units, Conversion Values and Baseline Efficiency Values by Chiller Type and Capacity in the Reference Tables section.
$CPLV_{ee}$	= Calculated Part Load Value based on trend data post measure install (kW/ton) = Actual installed
$EFLH^{1164}$	= Equivalent Full Load Hours for cooling in Existing Buildings or New Construction are provided in section 4.4 HVAC End Use.

¹¹⁶² Based on analysis of Itron eShape data for Missouri, calibrated to Illinois loads, supplied by Ameren. The AC load during the utility's peak hour is divided by the maximum AC load during the year.

¹¹⁶³ Based on analysis of Itron eShape data for Missouri, calibrated to Illinois loads, supplied by Ameren. The average AC load over the PJM peak period (1-5pm, M-F, June through August) is divided by the maximum AC load during the year.

¹¹⁶⁴ "2022 Illinois Statewide Technical Reference Manual for Energy Efficiency Version 10.0; Volume 2: Commercial and Industrial Measures; 4.4. HVAC End Use", Sept 2021, https://ilsag.s3.amazonaws.com/IL-TRM_Effective_010122_v10.0_Vol_2_C_and_I_09242021.pdf

SUMMER COINCIDENT PEAK DEMAND SAVINGS

$$\Delta kW_{SSP} = \text{TONS} * ((PE_{base}) - (PE_{ee})) * CF_{SSP}$$

$$\Delta kW_{PJM} = \text{TONS} * ((PE_{base}) - (PE_{ee})) * CF_{PJM}$$

Where:

PE_{base} = Peak efficiency of baseline equipment expressed as Full Load (kW/ton)

PE_{ee} = Peak efficiency of high efficiency equipment expressed as Full Load (kW/ton)

= Actual installed

CF_{SSP} = Summer System Peak Coincidence Factor for Commercial cooling (during system peak hour)

= 91.3%

CF_{PJM} = PJM Summer Peak Coincidence Factor for Commercial cooling (average during peak period)

= 47.8%

FOSSIL FUEL SAVINGS

N/A

WATER AND OTHER NON-ENERGY IMPACT DESCRIPTIONS AND CALCULATION

N/A

DEEMED O&M COST ADJUSTMENT CALCULATION

There are no expected O&M costs or savings associated with this measure.

MEASURE CODE: CI-HVC-CWTR-V1-230101

REVIEW DEADLINE: 1/1/2025

4.4.62 Cooling Tower Water Side Economizer

DESCRIPTION

A waterside economizer works by running the cooling tower loop in the winter and parts of the shoulder seasons as a source of cooling and transferring cooling energy to the building (secondary) cooling loop. This requires a dedicated plate-and-frame heat exchanger that is used only during waterside economizer operations, during which time the chillers are locked out.

A waterside economizer may contribute to reduced energy use in the following ways:

- Reducing the mechanical cooling load on chillers by pre-cooling return water
- Reducing energy use of the plant by allowing chillers to turn off at times of free cooling

Energy consumption (kWh) may decrease with the use of a waterside economizer because the leaving chilled water temperature can be reduced based on the wet bulb temperature. With this control strategy, the effect will be a reduction in motor speed (rpms) of the compressor as well as the pre-cooling of the chilled water return through the waterside economizer.

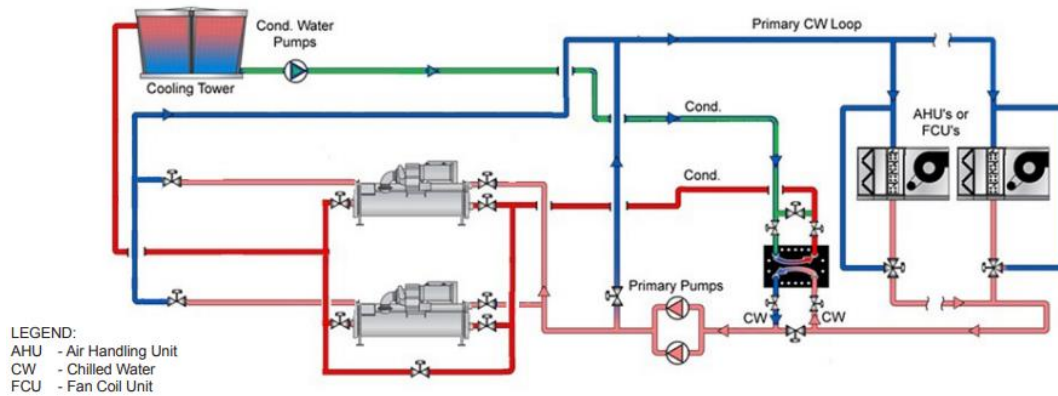

DEFINITION OF EFFICIENT EQUIPMENT

Installation of integrated waterside economizer heat exchanger to existing chilled-water system with cooling tower. Heat exchanger approach may range from 1° to 6°. Weather data is used to identify the annual hours in which outdoor air conditions are sufficient to provide water at a desirable temperature. Typically, demand savings may not be present with this measure because the process systems require water temperatures around 55-65°F and a cooling tower cannot meet these temperatures during the peak period.

DEFINITION OF BASELINE EQUIPMENT

No waterside heat exchanger installed or functional.

DEEMED LIFETIME OF EFFICIENT EQUIPMENT

The expected lifetime of the measure is 10 years¹¹⁶⁵

DEEMED MEASURE COST

Use actual chiller manufacturer provided cost.

LOADSHAPE

Loadshape C03 - Commercial Cooling

¹¹⁶⁵ (2008 Database for Energy-Efficiency Resources (DEER), Version 2008.2.05, "Effective/Remaining Useful Life Values", California Public Utilities Commission, December 16, 2008)

COINCIDENCE FACTOR

CF_{SSP} = Summer System Peak Coincidence Factor for Commercial cooling (during system peak hour)
 = 91.3%¹¹⁶⁶

CF_{PJM} = PJM Summer Peak Coincidence Factor for Commercial cooling (average during peak period)
 = 47.8%¹¹⁶⁷

Algorithm

CALCULATION OF ENERGY SAVINGS

ELECTRIC ENERGY SAVINGS

$$\Delta kWh = TONS * IPLV_{base} * (Hr)_{Free}$$

Where:

TONS = chiller nominal cooling capacity in tons (note: 1 ton = 12,000 Btu/hr)
 = Actual installed

IPLV_{base} = efficiency of baseline equipment expressed as Integrated Part Load Value (kW/ton). Chiller units are dependent on chiller type. See Chiller Units, Conversion Values and Baseline Efficiency Values by Chiller Type and Capacity in the Reference Tables section.
 = Actual installed

(Hr)_{Free} = Annual hours in which outdoor air conditions are sufficient to provide condenser water at a desirable temperature that the chiller does not need to operate.

SUMMER COINCIDENT PEAK DEMAND SAVINGS

N/A

FOSSIL FUEL SAVINGS

N/A

WATER AND OTHER NON-ENERGY IMPACT DESCRIPTIONS AND CALCULATION

N/A

DEEMED O&M COST ADJUSTMENT CALCULATION

There are no expected O&M costs or savings associated with this measure.

MEASURE CODE: CI-HVC-CTWE-V02-250101

REVIEW DEADLINE: 1/1/2027

¹¹⁶⁶ Based on analysis of Itron eShape data for Missouri, calibrated to Illinois loads, supplied by Ameren. The AC load during the utility’s peak hour is divided by the maximum AC load during the year.

¹¹⁶⁷ Based on analysis of Itron eShape data for Missouri, calibrated to Illinois loads, supplied by Ameren. The average AC load over the PJM peak period (1-5pm, M-F, June through August) is divided by the maximum AC load during the year.

4.4.63 Boiler Blowdown Heat Recovery

DESCRIPTION

This measure is for a non-residential steam boiler serving process load or space heating. The measure applies to steam natural gas fired boilers where the continuous blowdown exceeds 5% of the steam rate¹¹⁶⁸. Blowdown heat recovery systems should also be considered when about 500lbs/hr of steam is blown down and for continuous blowdown systems of at least 1 gpm¹¹⁶⁹. All steam boilers must blow down to reduce the amount of dissolved solids in the boiler water. However, along with the solids, boiler chemicals and thermal energy is lost. Although blowdown heat recovery systems cannot recover the chemicals, they do recover up to 90% of the heat energy that would otherwise be lost down the drain¹¹⁷⁰. Blowdown waste heat can be recovered with a heat exchanger, a flash tank, or a flash tank in a combination with a heat exchanger. The recovered heat is used to pre-heat boiler make-up water before it enters the deaerator, and for low pressure steam to heat water inside the deaerator, which improves overall boiler efficiency. Heat can be recovered from boiler blowdown by using a heat exchanger to preheat boiler makeup water. Additionally, changing from manual blowdown control to automatic control can reduce a boiler's energy use by 2 – 5 percent and reduce blowdown water losses by up to 20 percent.¹¹⁷¹

The measure is applicable to commercial applications, commercial HVAC including multifamily buildings, low pressure applications, medium pressure industrial applications and high pressure applications. It was developed to be applicable to the following program types: TOS, RF. If applied to other program types, the measure savings should be verified.

DEFINITION OF EFFICIENT EQUIPMENT

The efficient equipment is defined as a functional steam boiler with a blowdown heat recovery system that increases the heat recovery and boiler efficiencies in comparison to the baseline case. New systems are not eligible for this measure.

DEFINITION OF BASELINE EQUIPMENT

The baseline equipment is an existing steam boiler system with a deaerator where no blowdown heat is recovered

DEEMED LIFETIME OF EFFICIENT EQUIPMENT

The expected measure life is assumed to be 20 years; capped at the measure life of a steam boiler.¹¹⁷²

DEEMED MEASURE COST

If known, the actual material and labor cost of installation should be used. If unknown, the cost of this measure is estimated to be \$1.4/kBtu/hr¹¹⁷³ per boiler. This cost includes material and labor for installing boiler blowdown heat recovery systems (i.e - storage tanks, pipes and pumps).

¹¹⁶⁸ "Boiler Blowdown – Fact Sheet" N.C Division of Pollution Prevention and Environmental Assistance, August 2004.

<https://p2infohouse.org/ref/34/33027.pdf>,

¹¹⁶⁸ "ASHRAE: HVAC Service Life Database" ASHRAE, last modified May 12, 2023,

¹¹⁶⁹ "Blowdown Heat Recovery" Clean Boiler, 2005

<http://cleanboiler.org/learn-about/boiler-efficiency-improvement/efficiency-index/index-boiler-operations/blowdown-heat-recovery/#:~:text=A%20blowdown%20heat%20recovery%20system%20should%20be%20considered,Continuous%20blowdown%20systems%20of%20at%20least%201%20gpm>

¹¹⁷⁰ "Recover Heat from Boiler Blowdown" Department of Energy, January 2012.

https://www.energy.gov/sites/prod/files/2014/05/f16/steam10_boiler_blowdown.pdf

¹¹⁷¹ "Boiler Blowdown – Fact Sheet" N.C Division of Pollution Prevention and Environmental Assistance, last modified August 2004.

<https://p2infohouse.org/ref/34/33027.pdf>,

¹¹⁷² "ASHRAE: HVAC Service Life Database" ASHRAE, last modified May 12, 2023,

http://weblegacy.ashrae.org/publicdatabase/service_life.asp

¹¹⁷³ Results from Blowdown Heat Recovery efficiency improvement research through the C&I and Public Sector Custom Rebate Program, and Small Business Program. The evaluation included project and population data from years 2018 – 2023.

LOADSHAPE

N/A

COINCIDENCE FACTOR

For process boiler systems, the summer peak coincidence factor for this measure is dependent on the industrial shift and corresponding hours of operation. Values are provided for each shift type in the variable definition section.

N/A for space heating boiler systems.

Algorithm

CALCULATION OF ENERGY SAVINGS

ELECTRIC ENERGY SAVINGS

N/A

SUMMER COINCIDENT PEAK DEMAND SAVINGS

N/A

FOSSIL FUEL SAVINGS

Natural gas savings are calculated by estimating the amount of blowdown net heat flow. Savings are calculated from the enthalpy difference between the make-up water and the blowdown temperature.

$$\Delta\text{Therms} = \frac{\text{BFR} \times (H_B - H_w)}{\eta_{\text{boiler}} \times 100,000} \times \text{SF}$$

Where:

BFR = Boiler Blowdown flow rate in lb/year. The calculated blowdown flow rate is in turn used to calculate natural gas savings. Boiler heat recovery systems vary widely between manufacturers and facilities.

$$\text{BFR} = \text{Annual}_{\text{usage}} \times \% \text{BD}$$

Annual_{usage} = The annual steam usage in lbm/year.
 = Actual or if unknown:

$$\text{Annual}_{\text{usage}} = \left[\frac{\text{Hours} \times \text{Capacity}}{[(H_S - H_B)(1 - \%_{\text{make-up}}) + (H_S - H_w)(\%_{\text{make-up}})]} \right]$$

Capacity = Boiler input capacity in btu/hr.

%_{make-up} = Percentage of make-up water
 = 20%¹¹⁷⁴ or actual if known.

If space heating:

Hours = Equivalent Full Load Hours of heating in Existing Buildings; provided in section 4.4 HVAC End Use.

If process:

$$\text{Hours} = \text{Annual Hours} \times \text{UF}$$

¹¹⁷⁴ Okbaendrias, Biniam. Energy Management in Industries: Analysis of energy savings potential by steam condensate return. Page 10. About 75-85% of the total condensate return in reasonable

Annual Hours = Annual operating hours of the facility
 = Use actual or if unknown 8766¹¹⁷⁵

UF = Utilization Factor
 = Use actual or if unknown 41.9%¹¹⁷⁶

%BD = Blowdown Percentage
 = 5% for automatic or 7% for manual¹¹⁷⁷ or:

$$\%BD = \frac{1}{C_{\text{cycle}}}$$

C_{cycle} = Concentration cycles

$$C_{\text{cycle}} = \frac{F_c \times \text{cond}_{\text{target}}}{\text{cond}_{\text{feedwater}}}$$

= Actual if known

F_c = Conductivity Factor
 = 1 if automatic blowdown; 1.2¹¹⁷⁸ if manual blowdown

H_b = Enthalpy of the blowdown (Btu/lbm)

System Type	Supply Fluid Temperature ¹¹⁷⁹ (°F)	Enthalpy of Blowdown (Btu/lbm)
5 psi Steam (low pressure)	225	195.4
15 psi Steam (low pressure)	250	218.3
40 psi Steam (low pressure)	287	256.1
65 psi Steam (high pressure)	312	281.9
100 psi Steam (high pressure)	338	309.1
150 psi Steam (high pressure)	365	338.6

H_s = Enthalpy of supplied steam¹¹⁸⁰, (Btu/lbm)

System Type	Supply Fluid Temperature ¹¹⁸¹ (°F)	Enthalpy of Supplied Steam (Btu/lbm)
5 psi Steam (low pressure)	225	1155
15 psi Steam (low pressure)	250	1166
40 psi Steam (low pressure)	287	1176
65 psi Steam (high pressure)	312	1186

¹¹⁷⁵ From IL TRM

¹¹⁷⁶ From IL TRM Measure 4.4.54 Process Heating Boiler

¹¹⁷⁷ "Boiler Blowdown – Fact Sheet" N.C Division of Pollution Prevention and Environmental Assistance, August 2004.

<https://p2infohouse.org/ref/34/33027.pdf>

¹¹⁷⁸ "Boiler Blowdown – Fact Sheet" N.C Division of Pollution Prevention and Environmental Assistance, last modified August 2004.

<https://p2infohouse.org/ref/34/33027.pdf>

¹¹⁷⁹ A typical design uses a Δ20°F from hot water supply temperature to return temperature. ASHRAE. Boiler System Efficiency. 2006. <http://goesheatingsystems.com/wp-content/uploads/2015/04/BoilerEfficiencyArticle.pdf>

¹¹⁸⁰ Taken from IL TRM Measure 4.4.14 Pipe Insulation

¹¹⁸¹ A typical design uses a Δ20°F from hot water supply temperature to return temperature. ASHRAE. Boiler System Efficiency. 2006. <http://goesheatingsystems.com/wp-content/uploads/2015/04/BoilerEfficiencyArticle.pdf>

System Type	Supply Fluid Temperature ¹¹⁸¹ (°F)	Enthalpy of Supplied Steam (Btu/lbm)
100 psi Steam (high pressure)	338	1190
150 psi Steam (high pressure)	365	1196

- H_w = Enthalpy of incoming water from well or municipal system (Btu/lbm)
= 18.8 Btu/lbm for incoming water temperature of 50.7°F¹¹⁸²
- SF = 90% heat recovery¹¹⁸³.
- n_{boiler} = Efficiency of the steam boiler
= Actual or if unknown use default values given below:
= 80.7% for steam boilers, except multifamily low-pressure.¹¹⁸⁴
= 64.8% for multifamily low-pressure steam boilers.¹¹⁸⁵
- %_{boiler load} = The load percentage of the blowdown boiler In the total load. (i.e if only one boiler available in the facility, use 1)
- Cond_{feed water} = The conductivity of the feed water in μmho.
= Actual, If known.
= (%_{make-up}) × cond_{make up} + (1 - %_{make-up}) × cond_{return}
- Cond_{make up} = 317¹¹⁸⁶ μmho or actual if known.
- Cond_{return} = 20 μmho¹¹⁸⁷ or actual if known.
- Cond_{target} = The target conductivity following blowdown in μmho¹¹⁸⁸. Consult boilermaker for recommended TDS and max conductivity if available.

Boiler Type	Max TDS (ppm)	Max μmho
2 Pass Fire-Tube	4,500	6,716
3 Pass Fire-Tube	3,000 to 3,500	4,851
Low Pressure Water-Tube	2,000 to 3,000	3,731
Medium Pressure Water-Tube	1,500	2,239
High Pressure Water-Tube	1,000	1,493

¹¹⁸² Taken from IL TRM Measure 4.4.14 Pipe Insulation

¹¹⁸³ “Recover Heat from Boiler Blowdown” Department of Energy, last modified May 12, 2023.
https://www.energy.gov/sites/prod/files/2014/05/f16/steam10_boiler_blowdown.pdf

¹¹⁸⁴ Ibid

¹¹⁸⁵ Katrakis, J. and T.S. Zawacki. “Field-Measured Seasonal Efficiency of Intermediate-sized Low-Pressure Steam Boilers”. ASHRAE V99, pt. 2, 1993.

¹¹⁸⁶ “Comprehensive Chemical Analysis” City of Chicago – Department of Water Management – Bureau of Water Supply; Water Quality Division-Water Purification Laboratories, last modified May 12, 2023.
<https://www.chicago.gov/content/dam/city/depts/water/WaterQltyResultsNRpts/ccReports/CCA-2019-1-3.pdf>

¹¹⁸⁷ “Boiler Blowdown Automation Basics”, last modified January 23, 2017.

<https://www.yamathosupply.com/blogs/news/boiler-blowdown-automation-basics#:~:text=Involves%20manually%20opening%20a%20blowdown%20valve%20at%20various,target%20maximum%20lead%20to%20the%20formation%20of%20scale.>

¹¹⁸⁸ “Maximum permissible TDS”, last modified May 12, 2023.

<http://www2.spiraxsarco.com/resources/steam-engineering-tutorials/the-boiler-house/controlling-tds-in-the-boiler-water.asp>

For example, for a Chicago High School with a 10,000 kbtu/hr steam boiler in an 15 psi system with no blowdown heat recovery and existing manual blowdown.

$$BDR = \left[\frac{10,000,000 \times 1855}{((1,166 - 218.3)(1 - 0.2) + (1,166 - 18.8)(0.2))} \right] \times 0.07\% \text{ (manual blowdown)} = 1,314 \text{ klb/year}$$

$$\Delta\text{Therms} = \frac{1,314,803 \text{ lb/year} \times (218.3 - 18.8)}{80.7\% \times 100,000} \times 0.9 = 2,925 \text{ therms}$$

WATER AND OTHER NON-ENERGY IMPACT DESCRIPTIONS AND CALCULATION

N/A

DEEMED O&M COST ADJUSTMENT CALCULATION

Maintenance personnel should complete annual or semi-annual maintenance inspections of the condensate return system for its optimal performance. The O&M cost shall be included in cost-effectiveness calculations. It is recommended to service the following components to maintain the system’s proper operation: pumps, ensure periodic lubrication for motors, in accordance with the motor manufacturer’s guidelines. Strainers, traps should also be included as an O&M consideration. A custom calculation should be used as necessary.

MEASURE CODE: CI-HVC-BBHR-V01-240101

REVIEW DEADLINE: 1/1/2028

4.4.64 Steam Vent Condensers

DESCRIPTION

According to the Department of Energy⁶, vent condensers can be used with condensate systems to reduce the amount of energy needed to maintain steam temperatures. When flash steam is being vented to atmosphere, it carries with it the energy required to heat water to steam temperature, eventually wasted. Another condenser in the form of a heat exchanger attached to the condensate recovery system will allow this energy to remain within the system and thus reduce the energy needed to heat the condensate back up to the steam pressure necessary for operation. The recovered flash steam will also be distilled after eventually condensing and require less outside water to be introduced to the system. This improves longterm performance by reducing the need for undistilled feed water that has a higher concentration of heavy particulates that scale inside boilers and absorb heat, making the boilers less efficient.

This measure was developed to be applicable to the following program types: RF. If applied to other program types, the measure savings should be verified.

DEFINITION OF EFFICIENT EQUIPMENT

This measure requires that a heat exchanger be installed with capability to condense flash steam and return distilled water to the condensate tank.

DEFINITION OF BASELINE EQUIPMENT

This measure requires that a building must be equipped with steam boilers and a condensate recovery tank with flash steam venting in use. This also requires the building to be equipped with multiple pressure loads beyond heating applications and work within the parameters of fully efficient steam systems already. Steam equipment must meet baseline efficiency standards for boilers and condensate recovery, as well as working order steam traps.

DEEMED LIFETIME OF EFFICIENT EQUIPMENT

The expected measure of life is assumed to be 20 years.¹¹⁸⁹

DEEMED MEASURE COST

The measure cost of a vent condenser must be custom to the type installed and associated equipment necessary.

LOADSHAPE

N/A

COINCIDENCE FACTOR

N/A

Algorithm

¹¹⁸⁹ The efficiency for Heat Exchangers is stated at 27 years by ASHARE Table 4 Chapter 36, Comparison of Service Life Estimates, 2007 ASHRAE Handbook, HVAC Applications http://weblegacy.ashrae.org/publicdatabase/system_service_life.asp?selected_system_type=3. However, this is capped at 20 years due to the TRM specified.⁷ lifetime of steam boilers.

CALCULATION OF ENERGY SAVINGS

ELECTRIC ENERGY SAVINGS

N/A

SUMMER COINCIDENT PEAK DEMAND SAVINGS

N/A

FOSSIL FUEL SAVINGS

Natural gas energy savings are calculated for steam vent condensers per the equations given below.

$$\Delta Therms = \frac{Vent_{rate} \times (H_s - H_w) \times hours}{n_{boiler} \times 100,000} \times SF$$

Where:

$$Vent_{rate} = Condensate_{load} \times \%_{flash\ Steam}$$

Vent_{rate} = The rate at which steam passes through the vent (lb/hr)

Condensate_{load} = Estimated condensate load based on pipe size¹¹⁹⁰ (lb/hr)

$$Condensate_{load} = 114[Pipe_{size}]^{2.38}$$

Pipe_{size} = Diameter of vent pipe (inches)

%FlashSteam = Percentage of flash steam (%)

System Type	Flash Steam percentage ¹¹⁹¹ (°F)
5 psi Steam (low pressure)	1.6%
15 psi Steam (low pressure)	3.9%
40 psi Steam (low pressure)	7.8%
65 psi Steam (high pressure)	10.5%
100 psi Steam (high pressure)	13.3%
150 psi Steam (high pressure)	16.3%

If space heating:

Hours = = Equivalent Full Load Hours of heating in Existing Buildings; provided in section 4.4 HVAC End Use.

If process:

Hours = = Annual Hours × UF

Annual Hours = Annual operating hours of the facility

= Use actual or if unknown 8766

¹¹⁹⁰ Design of Fluid Systems Hook-ups by Spirax Sarco (1992) Page 37. Table 11 Minimum Dimensions of Flash Vessels. Max condensate quantity and Inlet and Flash Steam Outlet size were plotted against each other. Constants for a power trendline equation were obtained as a result. An oversize factor of 0.5 was applied to the maximum condensate load to account for times when exact pipe sizes cannot be obtained, and the next available pipe size needs to be selected.

¹¹⁹¹ Obtained from the Steam System Modeler Tool (SSM) Flash Tank Calculator by the Department of Energy (DOE). Saturated quality 0 and Tank Pressure 0 psig.

https://www4.eere.energy.gov/manufacturing/tech_deployment/amo_steam_tool/equipFlashtank

UF	= Utilization Factor = Use actual or if unknown 41.9% ¹¹⁹²
H _s	= Enthalphy of steam at venting pressure (Btu/lbm) = 1,150 Btu/lb for steam at atmospheric pressure.
H _w	= Enthalphy of incoming water from well or municipal system (Btu/lbm) = 18.8 Btu/lbm for incoming water temperature of 50.7°F ¹¹⁹³ .
n _{boiler}	= Efficiency of the steam boiler = Actual or if unknown use default values given below: = 80.7% for steam boilers, except multifamily low-pressure ¹¹⁹⁴ = 64.8% for multifamily low-pressure steam boilers ¹¹⁹⁵
SF	= Savings Factor = Percent of thermal steam energy recovered from vent = 90% of heat recovered. ¹¹⁹⁶

For example, a vent with a pipe diameter of 2 inches in a steam boiler operating year round at 15 psi

$$\begin{aligned}
 \text{Condensate}_{load} &= 114(2)^{2.38} = 594 \text{ lb/hr} \\
 \text{Vent}_{rate} &= 594 \times 3.9\% = 23.14 \text{ lb/hr} \\
 \Delta\text{Therms} &= \frac{(23.14) \times (1150 - 18.8) \times 8760}{80.7\% \times 100,000} \times 0.9 = 2,557 \text{ therms}
 \end{aligned}$$

WATER AND OTHER NON-ENERGY IMPACT DESCRIPTIONS AND CALCULATION

The methodology for calculating water savings involves obtaining the vent rate referenced above. Distilled condensate is ready for productive use to be reintroduced into the system.

DEEMED O&M COST ADJUSTMENT CALCULATION

N/A

MEASURE CODE: CI-HVC-STVC-V01-240101

REVIEW DEADLINE: 1/1/2028

¹¹⁹² From IL TRM Measure 4.4.54 Process Heating Boiler

¹¹⁹³ Taken from IL TRM Measure 4.4.14 Pipe Insulation

⁷ “ASHRAE: HVAC Service Life Database” ASHRAE, last modified May 12, 2023, http://weblegacy.ashrae.org/publicdatabase/service_life.asp

¹¹⁹⁴ Ibid

¹¹⁹⁵ Katrakis, J. and T.S. Zawacki. “Field-Measured Seasonal Efficiency of Intermediate-sized Low-Pressure Steam Boilers”. ASHRAE V99, pt. 2, 1993

¹¹⁹⁶ “Recover Heat from Boiler Blowdown” Department of Energy, last modified May 12, 2023.

https://www.energy.gov/sites/prod/files/2014/05/f16/steam10_boiler_blowdown.pdf

4.4.65 Computer Room Air Conditioner (CRAC)

DESCRIPTION

Computer Room Air Conditioning (CRAC) Units are installed to meet cooling requirements for computers, servers, and other electronic components. This measure promotes the installation of CRAC units by exploring the space cooling savings potential for the replacement or new commissioning of a computer room air conditioner.¹¹⁹⁷

This measure could apply to the replacing of an existing functional unit, an existing unit at the end of its useful life or the installation of a new unit in a new or existing building.

This measure was developed to be applicable to the following program types: TOS, NC. If applied to other program types, the measure savings should be verified.

DEFINITION OF EFFICIENT EQUIPMENT

The efficient equipment is assumed to be a CRAC Unit in the equipment categories expressed in Tables 1 and 2 that exceeds the energy efficiency requirements as prescribed by the program. The equipment must be categorized as either floor or ceiling mounted.

The equipment must possess a net sensible cooling capacity less than 760,000 Btu/h for equipment classified as upflow non-ducted or horizontal flow. Equipment that is classified as Downflow or upflow ducted shall not exceed the net sensible cooling capacity of 930,000 Btu/h.

DEFINITION OF BASELINE EQUIPMENT

The baseline equipment is assumed to be a standard-efficiency air-cooled, air-cooled with a fluid economizer, water-cooled, water-cooled with a fluid economizer, glycol-cooled, or glycol-cooled with a fluid economizer air conditioner that meets the Code energy efficiency requirements (IECC or Code of Federal Regulations whichever is higher) in effect on the date of equipment purchase (if date is unknown, assume current Code minimum).

In order for this characterization to apply, the baseline equipment is assumed to meet the efficiency requirements within the code in effect on the date of the building permit. As code requirements and adoption can differ from municipality to municipality, the user should verify which version of code is applicable given these constraints.

DEEMED LIFETIME OF EFFICIENT EQUIPMENT

The measure life is assumed to be 15 years.¹¹⁹⁸

DEEMED MEASURE COST

\$750 per ton incremental costs may be assumed. Actual CRAC costs vary widely in practice.¹¹⁹⁹

¹¹⁹⁷ "State of Minnesota Technical Reference Manual for Energy Conservation Improvement Programs" January 31st, 2024 <https://mn.gov/commerce-stat/trm/releases/4.1.pdf#page=319&zoom=100,93,96>

¹¹⁹⁸ ASHRAE Standard 90.1-2010 Equipment Final Rule Technical Support Document Chapter 6, Life-Cycle Cost and Payback Period Analysis

¹¹⁹⁹ "State of Minnesota Technical Reference Manual for Energy Conservation Improvement Programs" January 31st, 2024

LOADSHAPE

Loadshape is determined by the constant power draw by the equipment;

Loadshape C53 – Flat

COINCIDENCE FACTOR

The coincidence factor is determined by the constant power draw by the server room; the summer peak coincidence factor for the equipment is assumed to be 1.0

CFPJM = PJM Summer Peak Coincidence Factor for Commercial cooling (average during peak period)

Algorithm

CALCULATION OF ENERGY SAVINGS

ELECTRIC ENERGY SAVINGS

$$\Delta kWh = (\text{Size} * \text{LF} * \text{EFLH} * (1/\text{nSenCOPBASE} - 1/\text{nSenCOPEE})) / 0.2843$$

Where:

Size = the nominal cooling capacity rating of the energy efficient chiller (tons). 1 ton = 12,000 Btu/h
 = Actual

LF = Cooling load factor
 = 0.65¹²⁰⁰

0.2843 = conversion factor (0.2843 tons/ kWh)

NSenCOPBASE = minimum rated Net Sensible Coefficient of Performance (NSenCOP)¹²⁰¹. See Tables 1 and 2.

NSenCOPEE = rated Net Sensible Coefficient of Performance (NSenCOP) for the energy efficient CRAC
 = Actual

EFLH = Equivalent full load hour of cooling
 = 8,760 hours

¹²⁰⁰ ASHRAE Technical Support Document, 4.2.3.2 “Estimate the Average Computer Server Heat Load”, page 4-15.

¹²⁰¹ CRAC efficiencies are not represented by any other efficiency measurements such as IEER, EER, SEER, IPLV, or COP. Under AHRI Standard 1360-2017 (1361-2017), Net Sensible Cooling Capacity (not Total Cooling Capacity) is used to calculate a Net Sensible Coefficient of Performance.

SUMMER COINCIDENT PEAK DEMAND SAVINGS

$$\Delta kW = (\text{Size} * \text{LF} * \text{CF} * (1/\text{nsenCOPBASE} - 1/\text{nsenCOPEE})) / 0.2843$$

Where:

CF = Coincidence factor

= 1.0

Other factors as defined above

For example, an air-cooled upflow non-ducted CRAC is installed with a rated NsenCOP of 3.00, and net sensible cooling capacity of 60,000 Btu/h (5 tons). From Table 1, the baseline NsenCOP efficiency equals 2.16.

$$\begin{aligned} \Delta kWh &= (\text{Size} * \text{LF} * \text{EFLH} * (1/\text{nsenCOPBASE} - 1/\text{nsenCOPEE})) / 0.2843 \\ &= (5 \text{ tons} * 0.65 * 8760 \text{ hrs} * (1/2.16 - 1/3.0)) / 0.2843 \text{ tons/kWh} \\ &= \mathbf{12,982 \text{ kWh}} \end{aligned}$$

$$\begin{aligned} \Delta kW &= (\text{Size} * \text{LF} * \text{CF} * (1/\text{nsenCOPBASE} - 1/\text{nsenCOPEE})) / 0.284 \text{ ton/kW} \\ &= (5 \text{ tons} * 0.65 * 1 * (1/2.16 - 1/3.0)) / 0.2843 \text{ kW/ton} \\ &= \mathbf{1.48 \text{ Kw}} \end{aligned}$$

FOSSIL FUEL SAVINGS

N/A

WATER AND OTHER NON-ENERGY IMPACT DESCRIPTIONS AND CALCULATION

N/A

DEEMED O&M COST ADJUSTMENT CALCULATION

N/A

REFERENCE TABLES

Table 1—Amended Energy Conservation Standards for Floor-Mounted CRACs¹²⁰²

Equipment type	Net sensible cooling capacity ¹	Minimum NSenCOP efficiency		Net sensible cooling capacity	Minimum NSenCOP efficiency	
		Downflow	Upflow ducted		Upflow non-ducted	Horizontal flow
Air-Cooled	<80,000 Btu/h ²	2.70	2.67	<65,000 Btu/h	2.16	2.65
	≥80,000 Btu/h and <295,000 Btu/h	2.58	³ 2.55	≥65,000 Btu/h and <240,000 Btu/h	2.04	2.55
	≥295,000 Btu/h and <930,000 Btu/h	2.36	2.33	≥240,000 Btu/h and <760,000 Btu/h	1.89	2.47
Air-Cooled with Fluid Economizer	<80,000 Btu/h ≥80,000 Btu/h and <295,000 Btu/h	2.70 2.58	2.67 ³ 2.55	<65,000 Btu/h ≥65,000 Btu/h and <240,000 Btu/h	³ 2.09 ³ 1.99	2.65 2.55
	≥295,000 Btu/h and <930,000 Btu/h	2.36	2.33	≥240,000 Btu/h and <760,000 Btu/h	1.81	2.47
Water-Cooled	<80,000 Btu/h	2.82	2.79	<65,000 Btu/h	2.43	2.79
	≥80,000 Btu/h and <295,000 Btu/h	2.73	³ 2.70	≥65,000 Btu/h and <240,000 Btu/h	2.32	2.68
	≥295,000 Btu/h and <930,000 Btu/h	2.67	2.64	≥240,000 Btu/h and <760,000 Btu/h	2.20	2.60
Water-Cooled with Fluid Economizer	<80,000 Btu/h ≥80,000 Btu/h and <295,000 Btu/h	2.77 2.68	2.74 ³ 2.65	<65,000 Btu/h ≥65,000 Btu/h and <240,000 Btu/h	2.35 2.24	2.71 2.60
	≥295,000 Btu/h and <930,000 Btu/h	2.61	2.58	≥240,000 Btu/h and <760,000 Btu/h	2.12	2.54
Glycol-Cooled	<80,000 Btu/h	2.56	2.53	<65,000 Btu/h	2.08	2.48
	≥80,000 Btu/h and <295,000 Btu/h	2.24	2.21	≥65,000 Btu/h and <240,000 Btu/h	1.90	2.18
	≥295,000 Btu/h and <930,000 Btu/h	2.21	2.18	≥240,000 Btu/h and <760,000 Btu/h	1.81	2.18
Glycol-Cooled with Fluid Economizer	<80,000 Btu/h ≥80,000 Btu/h and <295,000 Btu/h	2.51 2.19	2.48 2.16	<65,000 Btu/h ≥65,000 Btu/h and <240,000 Btu/h	2.00 1.82	2.44 2.10
	≥295,000 Btu/h and <930,000 Btu/h	2.15	2.12	≥240,000 Btu/h and <760,000 Btu/h	1.73	2.10

¹ For downflow and upflow-ducted CRACs, the NSCC measured per AHRI 1360-2017 and the latest update to the standard, AHRI 1360-2022, is higher than the NSCC measured per the current Federal test procedure (which references ANSI/ASHRAE 127-2007). Therefore, to ensure equipment currently covered by Federal standards is not removed from coverage, DOE translated the currently applicable upper capacity limit for these classes (760,000 Btu/h) to NSCC as measured per AHRI 1360-2017 and AHRI 1360-2022, resulting in a crosswalked upper capacity boundary of 930,000 Btu/h. Consequently, DOE has used 930,000 Btu/h as the translated upper capacity limit for downflow and upflow-ducted CRACs in the analysis presented in this notice. For up-flow non-ducted CRACs, because there is no change in return air temperature conditions between ANSI/ASHRAE 127-2007 and AHRI 1360-2022, the capacity boundaries in ASHRAE Standard 90.1-2019 remain the same as those specified in the current Federal standards, and DOE correspondingly retains the current capacity boundaries. For horizontal-flow CRACs, DOE does not currently prescribe standards; therefore, a crosswalk of current capacity boundaries is not applicable. See section III.C.5 of this final rule for further discussion of DOE's crosswalk analysis of capacity boundaries for CRACs.

² Btu/h refers to "British thermal units per hour."

³ The amended standard for this equipment class is of equivalent stringency to the currently applicable Federal standard—the adopted level is a translation from the current metric (SCOP) to the adopted metric (NSenCOP) and aligns with the corresponding level in ASHRAE Standard 90.1.

¹²⁰² Office of Energy Efficiency and Renewable Energy, Department of Energy., "Energy Conservation Program: Energy Conservation Standards for Computer Room Air Conditioners" June 2nd, 2023

Table 2—Amended Energy Conservation Standards for Ceiling-Mounted CRACs¹²⁰³

Equipment type	Net sensible cooling capacity	Minimum NSenCOP efficiency	
		Ducted	Non-ducted
Air-Cooled with Free Air Discharge Condenser	<29,000 Btu/h ≥29,000 Btu/h and <65,000 Btu/h	2.05	2.02
	≥65,000 Btu/h and <760,000 Btu/h	1.92	1.94
Air-Cooled with Free Air Discharge Condenser and Fluid Economizer	<29,000 Btu/h ≥29,000 Btu/h and <65,000 Btu/h	2.01	1.97
	≥65,000 Btu/h and <760,000 Btu/h	1.87	1.89
Air-Cooled with Ducted Condenser	<29,000 Btu/h	1.86	1.89
	≥29,000 Btu/h and <65,000 Btu/h	1.83	1.86
	≥65,000 Btu/h and <760,000 Btu/h	1.73	1.75
Air-Cooled with Ducted Condenser and Fluid Economizer	<29,000 Btu/h ≥29,000 Btu/h and <65,000 Btu/h	1.82	1.78
	≥65,000 Btu/h and <760,000 Btu/h	1.68	1.70
Water-Cooled	<29,000 Btu/h	2.38	2.41
	≥29,000 Btu/h and <65,000 Btu/h	2.28	2.31
	≥65,000 Btu/h and <760,000 Btu/h	2.18	2.20
Water-Cooled with Fluid Economizer	<29,000 Btu/h ≥29,000 Btu/h and <65,000 Btu/h	2.33	2.23
	≥65,000 Btu/h and <760,000 Btu/h	2.13	2.16
Glycol-Cooled	<29,000 Btu/h	1.97	2.00
	≥29,000 Btu/h and <65,000 Btu/h	1.93	1.98
	≥65,000 Btu/h and <760,000 Btu/h	1.78	1.81
Glycol-Cooled with Fluid Economizer	<29,000 Btu/h ≥29,000 Btu/h and <65,000 Btu/h	1.92	1.88
	≥65,000 Btu/h and <760,000 Btu/h	1.73	1.76

MEASURE CODE: CI-HVC-CRAC-V01-250101

REVIEW DEADLINE: 1/1/2028

¹²⁰³ Office of Energy Efficiency and Renewable Energy, Department of Energy., “Energy Conservation Program: Energy Conservation Standards for Computer Room Air Conditioners” June 2nd, 2023

4.4.66 Steam Leak Repair

DESCRIPTION

The measure applies to the repair of steam leaks that allow steam to escape the steam distribution system. Steam leaks result in the loss of both latent heat and kinetic energy. The Steam Leak Repair measure is applicable to commercial applications, commercial HVAC (low pressure steam) including multifamily buildings, low-pressure, medium-pressure and high-pressure industrial applications. The measure is to be used when metered data is not available. Additional methods for estimating steam leak such as the plume length method may take precedence over this approach, especially for system operating pressures of 115 psig and higher.

Steam leaks that are found in steam traps must be addressed through measure 4.4.16 Steam Trap Replacement or Repair.

This measure was developed to be applicable to the following program types: RF. If applied to other program types, the measure savings should be verified.

DEFINITION OF EFFICIENT EQUIPMENT

Customer must repair steam leak by valve packing replacement, gasket replacement, long-term epoxy wrapping, or by welding when appropriate.

DEFINITION OF BASELINE EQUIPMENT

The baseline criterion is an individual steam leak in a low, medium or high-pressure steam system. No minimum leak rate is required. Any leak can be repaired or replaced.

DEEMED LIFETIME OF EFFICIENT EQUIPMENT

6 years for steam traps or other mechanical components.¹²⁰⁴ Welded repairs should use a default assumption of 18 years.¹²⁰⁵

DEEMED MEASURE COST

The cost for this measure can vary considerably depending on where the steam leak occurs and the work / parts required to repair it. Use custom costs where costs are not provided; otherwise use \$337¹²⁰⁶ / (lb/hr) of steam leak.

LOADSHAPE

N/A

Algorithm

CALCULATION OF ENERGY SAVINGS

ELECTRIC ENERGY SAVINGS

N/A

¹²⁰⁴ CLEARResult "Steam Traps Revision #1", August 2011. Primary studies used to prepare the source paper include Enbridge Steam Trap Survey, KW Engineering Steam Trap Survey, Enbridge Steam Saver Program 2005, Armstrong Steam Trap Survey, DOE Federal Energy Management Program Steam Trap Performance Assessment, Oak Ridge National Laboratory Steam System Survey Guide, KEMA Evaluation of PG&E's Steam Trap Program, Sept. 2007. Communication with vendors suggested an inverted bucket steam trap life typically in the range of 5 - 7 years, float and thermostatic traps 4- 6 years, float and thermodynamic disc traps of 1 - 3 years. Cost does not include installation.

¹²⁰⁵ Mazel, R E, and Anokhov, A E. Increasing the reliability of steam pipe welded joints. United States: Sov. Power Eng. (Engl. Transl.); (United States), Vol. 11:8; August 1982. Operating experience with thermal power plants shows that butt welds of steam pipes made of Cr-Mo-V steels have a satisfactory reliability over the course of 150,000 hours of operation.

¹²⁰⁶ Measure costs are based on data from seven steam leak projects provided by Franklin Energy Services.

SUMMER COINCIDENT PEAK DEMAND SAVINGS

N/A

FOSSIL FUEL SAVINGS¹²⁰⁷

$$\Delta Therm = \frac{S_a \times (H_v + H_s * (T_1 - T_{source})) * Hours}{100000 * \eta_B}$$

Where:

For Low Pressure Steam used in space heating applications (5psig or lower):

$$S_a = \text{Steam loss per leak lb/hr} = \frac{1519.3 * P_1 * D_1 * [(\frac{1}{T_1} * \frac{\gamma}{\gamma - 1}) * ((\frac{P_2}{P_1} * \frac{2}{\gamma}) - (\frac{P_2}{P_1} * \frac{\gamma + 1}{\gamma}))]}{2}$$

For all other steam systems and applications, use the following equation:

$$S_a = 24.24 * P_1 * D_1^2 * A * FF$$

Where:

- γ = heat capacity ratio
= $5.071 * 10^{-4} * P_1 + 1.332$
- P_1 = Average Steam Inlet Pressure (psia)
- P_2 = Average Steam Outlet Pressure. If unknown assume 14.696 psia.
- D_1 = Effective diameter of the leak. If unknown use $D_1 = 0.08 \text{ in}^{1208}$
- A = $50\%^{1209}$, all steam systems. This factor accounts for reduction in the maximum theoretical steam flow to the average steam flow (the Enbridge factor).
- H_v = Enthalpy of Vaporization in Btu/lb if unknown see Table below.
- H_s = Specific Heat of Water, (Btu/(lbm * °R))
= 1.001
- T_1 = Temperature of Saturated Steam (°R) = $507.89 * P_1^{0.0962}$, if unknown see Table below.
- T_{source} = Temperature at the source, if unknown see Table below:

¹²⁰⁷ See "Derivation of Equation for Subsonic Compressible Flow through an Orifice and Supporting Calculations for Illinois TRM Steam Trap Measure" paper for more information.

¹²⁰⁸ Diameter based on "Rule of Thumb for Estimating Energy Cost Savings from the Department of Energy Lean & Energy Toolkit: Appendix C | US EPA". High-pressure steam leaks (125 pounds per square inch gauge (psig) repairs are expected to save from \$150 to \$500 per leak per shift per year. The Department of Energy uses a natural Gas cost of \$0.35 per one hundred cubic feet (ccf). With an 80% boiler efficiency; the leak size is estimated at 342 CCF or 331 therms per leak per shift per year using the lower end of the cost savings. There are about 2,760 working hours per shift per year, which results in 0.17 therms per leak per hour. Utilizing the equation of steam loss per leaking trap from measures 4.4.16 steam trap replacement, the equivalent of 0.17 therm per leak per hour is a 0.08 orifice size. The analysis was also made for low-pressure steam leaks defined as 15 psig, costing \$30 to \$100 per leak per shift year. The same orifice size was obtained.

¹²⁰⁹ Enbridge adjustment factor used as referenced in CLEAResult "Work Paper Steam Traps Revision #2" Revision 3 dated March 2, 2012 and DOE Federal Energy Management Program Steam Trap Performance Assessment.

Steam System	Hv (btu/lb) ¹²¹⁰	T1 (°R)	Ts (°R) ¹²¹¹	Average Inlet Pressure (psig) ¹²¹²
Commercial Dry Cleaners	890	789.060	513.67	82.8
Multifamily LPS	951	672.103	513.67	3.7
Multifamily LPS ≥ 5 psig and < 15 psig	951	694.581	513.67	11.2
Commercial LPS Space Heat < 15 psig	951	694.581	513.67	11.2
Industrial or Process Low Pressure, < 15 psig	951	694.581	513.67	11.2
Medium Pressure > 15 psig < 30 psig	944	706.036	513.67	16
Medium Pressure ≥ 30 < 75 psig	915	755.079	513.67	47
High Pressure ≥ 75 < 125 psig	880	802.160	513.67	101
High Pressure ≥ 125 < 175 psig	859	827.918	513.67	146
High Pressure ≥ 175 < 250 psig	837	852.076	513.67	202
High Pressure ≥ 250 < 300 psig	816	872.652	513.67	263

Hours = Hours of plant operation

= Actual, if unknown, use default hours provided below:

Steam System	Zone (where applicable)	Hours/Yr ¹²¹³
Commercial Dry Cleaners	All Climate Zones	2,425
Industrial/Process Low Pressure: psig < 15		8,282
Medium Pressure: 15 ≤ psig < 30		8,282
Medium Pressure: 30 ≤ psig < 75		8,282
High Pressure: 75 ≤ psig < 125		8,282
High Pressure: 125 ≤ psig < 175		8,282
High Pressure: 175 ≤ psig < 250		8,282
High Pressure: 250 ≤ psig < 300		8,282
High Pressure: 300 ≤ psig		8,282
Commercial Space Heating LPS	Rockford	4,272
	Chicago	4,029
	Springfield	3,406
	Belleville	2,515
	Marion	2,546

¹²¹⁰ Latent heat of vaporization of steam at the inlet pressure to the steam trap. Implicit assumption that the average boiler nominal pressure where the vaporization occurs, is essentially that same pressure. Referenced in CLEARResult “Work Paper Steam Traps Revision #2” Revision 3 dated March 2, 2012.

¹²¹¹ US DOE Building America Program. Building America Analysis Spreadsheet. For Chicago, IL

¹²¹² Commercial and Industrial low pressure steam trap inlet pressure based on Franklin Energy and Opinion Dynamics analysis of data collected by Armstrong for 120,833 steam traps. Data covered coil, process, and radiator steam trap applications on modulating and constant pressure systems less than 15psi. Medium and high pressure steam trap inlet pressure based on Navigant analysis of source collected during program implementation by Nicor Gas for GPY1 through GPY4. For each steam trap project, the data provided measure savings description, operating pressure, installation Zip code, business building type, program year, and annual operating hours. Dry cleaning steam trap inlet pressure based on C5 Steam Traps – Nicor FINAL 10.27.11.

¹²¹³ Medium and high-pressure steam trap annual operating hours based on Navigant analysis of source collected during program implementation by Nicor Gas for GPY1 through GPY4. For each steam trap project, the data provided measure savings description, operating pressure, installation Zip code, business building type, program year, and annual operating hours.

Steam System	Zone (where applicable)	Hours/Yr ¹²¹³
Multifamily Space Heating LPS	<p>For steam traps that are part of steam systems where the boiler cycles on/off to maintain space setpoint temperature or for steam traps located downstream of a steam control valve that opens/closes to maintain setpoint temperature, use Heating EFLH values in Section 4.4 for High Rise or Mid-Rise MF buildings.</p> <p>For steam traps that are exposed to steam continuously throughout the heating season, use the values listed above for Commercial Space Heating LPS for your appropriate climate zone.</p>	

η_B = Boiler Efficiency %
 = Actual, if unknown assume 80.7%¹²¹⁴ for commercial and industrial
 = 64.8%¹²¹⁵ for multifamily low-pressure steam boilers

For example, a steam leak in a 45 psig system in a commercial application operating 1 shift

$$\Delta\text{Therm} = S_a * (H_v + H_s (T_1 - T_{\text{source}})) * \text{Hours} / (100000 * \eta_B)$$

$$S_a = 24.24 * P_1 * D_1^2 * A * FF$$

$$S_a = 24.24 * (45 + 14.696) * 0.08^2 * 50\% * 100\%$$

$$S_a = 4.630 \text{ lb/hr}$$

$$\Delta\text{Therm} = 4.63 * (-915 + 1.001 * (755.079 - 513.67)) * 2760 / (100000 * 80.7\%)$$

$$= 183.155 \text{ therms}$$

WATER AND OTHER NON-ENERGY IMPACT DESCRIPTIONS AND CALCULATION

$$\Delta\text{Water} = \text{GAL} * \text{Hours}$$

Where:

GAL = average actual water volume saved per leak per system
 = $S_a / 8.33 \text{ (lb/gal)}$

Other variables as defined above.

Deemed O&M Cost Adjustment Calculation

N/A

¹²¹⁴ Ibid

¹²¹⁵ Katrakis, J. and T.S. Zawacki. "Field-Measured Seasonal Efficiency of Intermediate-sized Low-Pressure Steam Boilers". ASHRAE V99, pt. 2, 1993.

MEASURE CODE: CI-HVC-SLKR-V01-250101

REVIEW DEADLINE: 1/1/2028

4.5. Lighting End Use

The commercial lighting measures use a standard set of variables for hours of use, waste heat factors, coincident factors and HVAC interaction effects. This table has been developed based on information provided by the various stakeholders. For ease of review, the table is included here and referenced in each measure.

The building characteristics of the eQuest models can be found in the reference table named “EFLH Building Descriptions Updated 2014-11-21.xlsx”. The OpenStudio models are based upon the DOE Prototypes described in NREL’s “U.S. Department of Energy Commercial Reference Building Models of the National Building Stock” and a calibration log file that documents all of the variations made to each model to get them calibrated is provided in “IL-Calibration-Log_2019-08-27.xlsx”. Documents and all models are all available on the SharePoint site.

Note where a measure installation is within a building or application that does not fit with any of the defined building types below, the user should apply custom assumptions where it is reasonable to estimate them, else the building of best fit should be utilized.

Building/Space Type	Fixture Annual Operating Hours ¹²¹⁶	Screw based bulb Annual Operating hours ¹²¹⁷	Waste Heat Cooling Energy WHFe ¹²¹⁸	Waste Heat Cooling Demand WHFd	Coincidence Factor CF ¹²¹⁹	Waste Heat Gas Heating IFTherms ¹²²⁰	Waste Heat Electric Resistance Heating IFkWh ¹²²¹	Waste Heat Electric Heat Pump Heating IFkWh	Model Source
Agriculture – Chicken Broilers ¹²²²	3,251	3,251	1.00	1.00	0.76	0.000	0.000	0.000	n/a
Agriculture – Chicken Breeders	4,606	4,606	1.00	1.00	0.95	0.000	0.000	0.000	n/a
Agriculture – Chicken Layers	4,914	4,914	1.00	1.00	0.95	0.000	0.000	0.000	n/a

¹²¹⁶Fixtures hours of use are based upon schedule assumptions used in the eQuest models, except for those building types where Illinois based metering results provide a statistically valid estimate (currently: College, Elementary School, High School, Manufacturing, Low and Mid rise Office, Retail Department Store and Warehouse) or Grocery which is based on logging survey at 28 grocery stores in a Massachusetts DNV-GL “Lighting Hours of Use Study” report, April 12,2019. Miscellaneous is a weighted average of indoor spaces using the relative area of each building type in the region (CBECS).

¹²¹⁷ Hours of use for screw based bulbs are derived from DEER 2008 by building type for cfls. Garage, exterior and multi-family common area values are from the Hours of Use Table in this document. Miscellaneous is an average of interior space values. Some building types are averaged when DEER has two values: these include office, restaurant and retail. Healthcare clinic uses the hospital value.

¹²¹⁸ The Waste Heat Factor for Energy and is developed using EQuest models for various building types base on Chicago Illinois (closest to statewide average HDD and CDD). Exterior and garage values are 1, unknown is a weighted average of the other building types.

¹²¹⁹Coincident diversity factors are based on either combined IL evaluation results (College, Elementary School, High School, Manufacturing, Low and Mid rise Office, Retail Department Store and Warehouse), case lighting projects performed over several years by Michaels Energy in Illinois and other jurisdictions (Refrigerated and Freezer Cases), or based upon schedules defined in the eQuest models described (all others).

¹²²⁰ IFkWh Resistance value is developed using EQuest or OpenStudio models consistent with methodology for Waste Heat Factor for Energy.

¹²²¹ Heat penalty assumptions are based on converting the IFkWh Resistance multiplier value in to IFtherms or IF kWhHeat Pump by applying relative heating system efficiencies. The gas efficiency was assumed to be 80% AFUE and the electric resistance is assumed to be 100%, for Heat Pump is assumed to be 2.3COP.

¹²²² Agriculture lighting loadshapes, operational hours, and HVAC interactive factors were developed based on field experience and research material for the general agriculture, indoor agriculture, poultry and dairy commodities. Please see the excel files, ‘General Agriculture Loadshape’ and ‘Indoor Agriculture Lighting Loadshape’ on the 8760-calculation approach and for more detail. Due to livestock housing having little to no mechanical cooling systems, waste heat cooling and associated demand factors were assumed to be 1.00.

Building/Space Type	Fixture Annual Operating Hours ¹²¹⁶	Screw based bulb Annual Operating hours ¹²¹⁷	Waste Heat Cooling Energy WHFe ¹²¹⁸	Waste Heat Cooling Demand WHFd	Coincidence Factor CF ¹²¹⁹	Waste Heat Gas Heating IFTherms ¹²²⁰	Waste Heat Electric Resistance Heating IFkWh ¹²²¹	Waste Heat Electric Heat Pump Heating IFkWh	Model Source
Agriculture – Turkey Hens	2,231	2,231	1.00	1.00	0.76	0.000	0.000	0.000	n/a
Agriculture – Turkey Toms	5,351	5,351	1.00	1.00	0.95	0.000	0.000	0.000	na
Agriculture – Turkey Breeder Hens	4,396	4,396	1.00	1.00	0.95	0.000	0.000	0.000	n/a
Agriculture – Turkey Breeder Toms	5,446	5,446	1.00	1.00	0.95	0.000	0.000	0.000	n/a
Agriculture – Dairy Long Day Lighting	6,205	6,205	1.00	1.00	0.95	0.000	0.000	0.000	n/a
Assisted Living	7,862	5,950	1.14	1.30	0.66	0.035	0.823	0.358	eQuest
Auto Dealership	4,099	2,935	1.16	1.24	0.97	0.013	0.315	0.137	OpenStudio
Childcare/Pre-School	2,860	2,860	1.17	1.29	0.72	0.018	0.420	0.183	eQuest
College	3,395	2,588	1.02	1.54	0.63	0.023	0.548	0.238	OpenStudio
Convenience Store	4,672	3,650	1.09	1.26	0.76	0.035	0.828	0.360	eQuest
Drug Store	4,093	2,935	1.05	1.34	1.00	0.017	0.394	0.171	OpenStudio
Elementary School	3,038	2,118	1.04	1.51	0.65	0.019	0.455	0.198	OpenStudio
Emergency Services	2,698	3,088	1.06	1.09	0.65	0.001	0.014	0.006	OpenStudio
Garage	3,401	3,540	1.00	1.00	0.92	0.000	0.000	0.000	eQuest
Garage, 24/7 lighting	8,766	8,766	1.00	1.00	1.00	0.000	0.000	0.000	eQuest
Grocery	5,468	3,650	1.05	1.22	0.82	0.010	0.230	0.100	OpenStudio
Healthcare Clinic	3,890	4,207	1.14	1.04	0.67	0.020	0.463	0.201	OpenStudio
High School	3,038	2,327	1.15	1.40	0.65	0.011	0.249	0.108	OpenStudio
Hospital - CAV no econ	7,616	4,207	1.17	1.32	0.56	0.009	0.211	0.092	OpenStudio
Hospital - CAV econ	7,616	4,207	1.14	1.27	0.56	0.009	0.205	0.089	OpenStudio
Hospital - VAV econ	7,616	4,207	1.13	1.35	0.56	0.006	0.148	0.064	OpenStudio
Hospital - FCU	7,616	4,207	1.16	1.42	0.56	0.000	0.000	0.000	OpenStudio
Manufacturing Facility	4,618	2,629	1.02	1.04	0.81	0.012	0.270	0.117	eQuest
MF - High Rise - Common	6,138	5,950	1.20	1.24	0.90	0.005	0.109	0.047	OpenStudio
MF - Mid Rise - Common	5,216	5,950	1.11	1.16	0.62	0.021	0.484	0.211	OpenStudio
Hotel/Motel - Guest	2,390	777	1.17	1.21	0.46	0.020	0.468	0.204	OpenStudio
Hotel/Motel - Common	6,138	4,542	1.09	1.26	0.85	0.017	0.406	0.176	OpenStudio
Movie Theater	3,506	5,475	1.11	1.38	0.53	0.029	0.673	0.293	eQuest
Office - High Rise - CAV no econ	2,886	3,088	1.22	1.30	0.60	0.006	0.149	0.065	OpenStudio
Office - High Rise - CAV econ	2,886	3,088	1.00	1.07	0.57	0.039	0.905	0.394	eQuest
Office - High Rise - VAV econ	2,886	3,088	1.06	1.65	0.60	0.015	0.345	0.150	OpenStudio

Building/Space Type	Fixture Annual Operating Hours ¹²¹⁶	Screw based bulb Annual Operating hours ¹²¹⁷	Waste Heat Cooling Energy WHFe ¹²¹⁸	Waste Heat Cooling Demand WHFd	Coincidence Factor CF ¹²¹⁹	Waste Heat Gas Heating IFTherms ¹²²⁰	Waste Heat Electric Resistance Heating IFkWh ¹²²¹	Waste Heat Electric Heat Pump Heating IFkWh	Model Source
Office - High Rise - FCU	2,886	3,088	1.21	1.17	0.60	0.007	0.153	0.067	OpenStudio
Office - Low Rise	2,698	3,088	1.10	1.26	0.52	0.010	0.231	0.100	OpenStudio
Office - Mid Rise	3,266	3,088	1.10	1.36	0.60	0.016	0.378	0.164	OpenStudio
Religious Building	2,085	1,664	1.12	1.37	0.48	0.015	0.356	0.155	eQuest
Restaurant	5,571	4,784	1.08	1.10	1.00	0.009	0.208	0.090	OpenStudio
Retail - Department Store	4,099	2,935	1.06	1.06	0.94	0.015	0.346	0.150	OpenStudio
Retail - Strip Mall	4,093	2,935	1.12	1.29	0.71	0.019	0.450	0.196	eQuest
Warehouse	3,135	4,293	1.02	1.17	0.85	0.016	0.378	0.164	OpenStudio
Unknown	3,379	3,612	1.08	1.30	0.67	0.015	0.354	0.154	n/a
Exterior – dusk to dawn ¹²²³	4,303	4,303	1.00	1.00	0.00	0.000	0.000	0.000	n/a
Exterior – dusk to business close	See calculation below		1.00	1.00	0.00	0.000	0.000	0.000	n/a
Low-Use Small Business	2,954	2,954	1.31	1.53	0.66	0.023	0.524	0.262	n/a
Uncooled Building	Varies	Varies	1.00	1.00	0.66	0.014	0.320	0.160	n/a
Refrigerated Cases	5,802	n/a	1.29 ¹²²⁴	1.29	1.00	0.000	0.000	0.000	n/a
Freezer Cases	5,802	n/a	1.50 ¹²²⁵	1.5	1.00	0.000	0.000	0.000	n/a

Annual Operating Hours – Spaces with Lighting Controls

For spaces where occupancy or daylight sensors are known to be already installed, the user should adjust the Annual Operating Hours using the formula below. For v9.0, the TAC agreed that if current state is unknown by the implementer, then subsequent evaluation should assume the space does not have lighting controls. Over 2021 program year, this should be evaluated and the TAC will determine if a different unknown assumption should be used from V10 on.

$$\text{Sensor Controlled Hours} = \text{Annual Operating Hours} * (1 - \text{ESF})$$

Where:

¹²²³ Based on Navigant verified value using 2014 Astronomical Applications Department, U.S. Naval Observatory data for ComEd’s service territory. See Navigant Memorandum ‘RE: LED Street Lighting Program Hours of Use for the ComEd and DCEO Programs. June 21, 2017’.

¹²²⁴ For closed refrigerated case lighting (open cases should use building type WHF), the value is 1.29 (calculated as $(1 + (1.0 / 3.5))$). Based on the assumption that all lighting in refrigerated cases is mechanically cooled, with a typical 3.5 COP refrigeration system efficiency, and assuming 100% of lighting heat needs to be mechanically cooled at time of summer peak. Assumes 3.5 COP for medium temp cases based on the average of standard reciprocating and discus compressor efficiencies with Saturated Suction Temperatures of 20°F and a condensing temperature of 90°F.

¹²²⁵ For closed freezer case lighting (open cases should use building type WHF), the value is 1.50 (calculated as $(1 + (1.0 / 2.0))$). Based on the assumption that all lighting in freezer cases is mechanically cooled, with a typical 2.0 COP freezer system efficiency, and assuming 100% of lighting needs to be mechanically cooled at time of summer peak. Assumes 2.0 COP for low temp cases based on the average of standard reciprocating and discus compressor efficiencies with Saturated Suction Temperatures of -20°F and a condensing temperature of 90°F.

Annual Operating Hours = Average hours of use per year for specific space type, provided in the Reference Table above.

ESF = Energy Savings factor (represents the percentage reduction to the operating Hours from the non-controlled baseline lighting system),

Table from Measure 4.5.10 Lighting Controls:

Lighting Control Type	Energy Savings Factor ¹²²⁶
Fixture Measurement of Control savings through Networked Trending	Custom
Interior Occupancy Sensor (Switch, Wall, Fixture or Remote Mounted or Integrated in Fixture)	24% 37% with High End Trim
Interior Occupancy Sensor configured as "Vacancy Sensor" (Switch, Wall, Fixture or Remote Mounted or Integrated in Fixture)	31% 44% with High End Trim
Interior Daylight Sensor (Wall, Fixture or Remote Mounted)	28% 41% with High End Trim
Interior Dual Occupancy & Daylight Sensor (Integrated of Fixture Mounted)	38% 51% with High End Trim
Interior Networked Luminaire-Level Lighting Controls	61%
Interior Networked Lighting Controls Only with No LLLCs	35%
Interior Networked Lighting Controls (Unknown or mixed LLLCs)	49%
Refrigerated Case Occupancy Sensor – Freezer and Cooler	27%
Exterior Occupancy Sensor	41%
No Lighting Control	0%

Note, if a program is installing lighting fixtures *and* controls, the interactive effect should be accounted for by assuming fixture watt savings for full annual operating hours, control savings on efficient fixture.

Exterior Lighting Hours – dusk to business close

$$\text{Hours} = (6.19 * \text{Days}) + (\% \text{Adj} * \text{Days})$$

Where:

$$6.19 = \text{Average hours per day between dusk and midnight}^{1227}$$

¹²²⁶ Interior controls % savings based except where noted on LBNL, Williams et al, "Lighting Controls in Commercial Buildings", 2012, p172. ESF for Vacancy Sensors is based on Papamichael, Konstantions, Bi-Level Switching in Office Spaces, California Lighting Technology Center, February 1,2010. See Figure 8 on page 10 for relevant study results. The study shows a 30% extra savings above a typical occupancy sensor; 24% * 1.3 = 31%.

ESF for Luminaire Level Lighting Controls, and 10% High End Trim adder are based upon review of:

Pacific Northwest National Laboratory, "Evaluation of Advanced Lighting Control Systems in a Working Office Environment", November 2018.

Schuetter et al., "Cree SmartCast Lighting Retrofit Demonstration: LED Fixtures and Controls for Advanced Holistic Lighting Solutions", September 2020 (expected).

DesignLights Consortium and NEEA, "Energy Savings from Networked Lighting Control and Luminaire-level Lighting Control Systems: 2020 Update", 2020 (expected).

Refrigerated Case occupancy sensors ESF is based on percentage of operating hours spent in low-power operation during vacant periods, found in SDG&E workpaper: WPSDGENRLG0027.

Exterior sensors are based upon data from "Application Assessment of Bi-Level LED Parking Lot Lighting" p6.

¹²²⁷ Calculated using the eQuest model by finding the total number of hours of exterior lighting consumption between dusk and midnight and dividing by 365 (2261 / 365 = 6.19 hours per day).

Days = Days of business operation

= Actual

%Adj = Percent adjustment dependent on hour closing¹²²⁸

Business closes at	4pm	5pm	6pm	7pm	8pm	9pm	10pm	11pm	12pm	1am	2am	3am
%Adj	-619%	-604%	-564%	-500%	-400%	-300%	-200%	-100%	0%	100%	200%	300%

For example a business open until 8pm, 260 days per year, would assume:

$$\text{Hours} = (6.19 * 260) + (-400\% * 260) = 569.4 \text{ hours}$$

¹²²⁸ See "IL TRM Ext Lighting.xlsx" for calculation.

4.5.1 Commercial ENERGY STAR Compact Fluorescent Lamp (CFL) – Retired 12/31/2018,
Removed in v8

4.5.2 Fluorescent Delamping

DESCRIPTION

This measure addresses the permanent removal of existing 8', 4', 3', and 2' fluorescent lamps. Unused lamps, lamp holders, and ballasts must be permanently removed from the fixture. This measure is applicable when retrofitting from T12 lamps to T8 lamps or simply removing lamps from a T8 fixture. Removing lamps from a T12 fixture that is not being retrofitted with T8 lamps are not eligible for this incentive.

Customers are responsible for determining whether or not to use reflectors in combination with lamp removal in order to maintain adequate lighting levels. Lighting levels are expected to meet the Illuminating Engineering Society of North America (IESNA) recommended light levels. Unused lamps, lamp holders, and ballasts must be permanently removed from the fixture and disposed of in accordance with local regulations. A pre-approval application is required for lamp removal projects.

This measure was developed to be applicable to the following program types: RF. If applied to other program types, the measure savings should be verified.

DEFINITION OF EFFICIENT EQUIPMENT

Savings are defined on a per removed lamp basis. The retrofit wattage (efficient conditioned) is therefore assumed to be zero. The savings numbers provided below are for the straight lamp removal measures, as well as the lamp removal and install reflector measures. The lamp installed/retrofit is captured in another measure.

DEFINITION OF BASELINE EQUIPMENT

The baseline condition is either a T12 or a T8 lamp with default wattages provided below. Note, if the program does not allow for the lamp type to be known, then a T12:T8 weighting of 40%:60% can be applied.¹²²⁹

DEEMED LIFETIME OF EFFICIENT EQUIPMENT

The measure life is assumed to be 11 years per DEER 2005.

DEEMED MEASURE COST

The incremental capital cost is provided in the table below:

Measure Category	Value	Source
8-Foot Lamp Removal	\$16.00	ComEd/KEMA regression ¹²³⁰
4-Foot Lamp Removal	\$12.00	ICF Portfolio Plan
8-Foot Lamp Removal with reflector	\$30.00	KEMA Assumption
4-Foot Lamp Removal with reflector	\$25.00	KEMA Assumption
2-Foot or 3-Foot Removal	\$12.35	KEMA Assumption
2-Foot or 3-Foot Removal with reflector	\$25.70	KEMA Assumption

LOADSHAPE

- Loadshape C06 - Commercial Indoor Lighting
- Loadshape C07 - Grocery/Conv. Store Indoor Lighting
- Loadshape C08 - Hospital Indoor Lighting
- Loadshape C09 - Office Indoor Lighting

¹²²⁹ Based on ComEd's 2019 Baseline Survey results indicating approximately 40% of linear fixtures are T12s.

¹²³⁰ Based on the assessment of active projects in the 2008-09 ComEd Smart Ideas Program. See files "ltg costs 12-10-10.xl." and "Lighting Unit Costs 102605.doc".

- Loadshape C10 - Restaurant Indoor Lighting
- Loadshape C11 - Retail Indoor Lighting
- Loadshape C12 - Warehouse Indoor Lighting
- Loadshape C13 - K-12 School Indoor Lighting
- Loadshape C14 - Indust. 1-shift (8/5) (e.g., comp. air, lights)
- Loadshape C15 - Indust. 2-shift (16/5) (e.g., comp. air, lights)
- Loadshape C16 - Indust. 3-shift (24/5) (e.g., comp. air, lights)
- Loadshape C17 - Indust. 4-shift (24/7) (e.g., comp. air, lights)
- Loadshape C18 - Industrial Indoor Lighting
- Loadshape C19 - Industrial Outdoor Lighting
- Loadshape C20 - Commercial Outdoor Lighting

COINCIDENCE FACTOR

The summer peak coincidence factor for this measure is dependent on the location type. Values are provided for each building type in the reference section below.

Algorithm

CALCULATION OF SAVINGS

ELECTRIC ENERGY SAVINGS

$$\Delta kWh = ((WattsBase - WattsEE) / 1,000) * ISR * Hours * WHFe$$

Where:

WattsBase = Assume wattage reduction of lamp removed

	Wattage of lamp removed ¹²³¹		Weighted average
	T8	T12	40% T12, 60% T8
8-ft T8	38.6	60.3	47.3
4-ft T8	19.4	33.7	25.1
3-ft T8	14.6	40.0	24.8
2-ft T8	9.8	28.0	17.1

WattsEE = 0

ISR = In Service Rate or the percentage of units rebated that get installed.
 =100% if application form completed with sign off that equipment permanently removed and disposed of.

Hours = Average hours of use per year are provided in Reference Table in Section 4.5. If unknown use the Miscellaneous value.

WHFe = Waste heat factor for energy to account for cooling energy savings from efficient lighting are provided below for each building type in Reference Table in Section 4.5. If unknown, use the Miscellaneous value.

¹²³¹ Default wattage reduction is based on averaging the savings from moving from a 2 to 1, 3 to 2 and 4 to 3 lamp fixture, as provided in the Standard Performance Contract Procedures Manual: Appendix B: Table of Standard Fixture Wattages, Version 3.0, SCE, March 2004. An adjustment is made to the T8 delamped fixture to account for the significant increase in ballast factor. See 'Delamping calculation.xls' for details.

For example, delamping a 4 ft T8 fixture in a mid rise office building:

$$\begin{aligned} \Delta kWh &= ((19.4 - 0)/1,000) * 1.0 * 4439 * 1.17 \\ &= 100.8 \text{ kWh} \end{aligned}$$

HEATING PENALTY

If electrically heated building:

$$\Delta kWh_{\text{heatpenalty}}^{1232} = (((\text{WattsBase}-\text{WattsEE})/1000) * \text{ISR} * \text{Hours} * -\text{IFkWh}$$

Where:

IFkWh = Lighting-HVAC Interaction Factor for electric heating impacts; this factor represents the increased electric space heating requirements due to the reduction of waste heat rejected by the efficient lighting. Values are provided in the Reference Table in Section 4.5. If unknown, use the Miscellaneous value.

For example, delamping a 4 ft T8 fixture in a heat pump heated mid rise office building:

$$\begin{aligned} \Delta kWh_{\text{heatpenalty}} &= ((19.4 - 0)/1,000) * 1.0 * 4439 * -0.104 \\ &= -9.0 \text{ kWh} \end{aligned}$$

SUMMER COINCIDENT PEAK DEMAND SAVINGS

$$\Delta kW = ((\text{WattsBase}-\text{WattsEE})/1000) * \text{ISR} * \text{WHFd} * \text{CF}$$

Where:

WHFd = Waste heat factor for demand to account for cooling savings from efficient lighting in cooled buildings is provided in the Reference Table in Section 4.5. If unknown, use the Miscellaneous value..

CF = Summer Peak Coincidence Factor for measure is provided in the Reference Table in Section 4.5. If unknown, use the Miscellaneous value..

Other factors as defined above

For example, delamping a 4 ft T8 fixture in a mid rise office building:

$$\begin{aligned} \Delta kW &= ((19.4 - 0)/1,000) * 1.0 * 1.62 * 0.6 \\ &= 0.019 \text{ kW} \end{aligned}$$

FOSSIL FUEL SAVINGS

Heating Penalty if fossil fuel heated building (or if heating fuel is unknown):

$$\Delta \text{Therms}^{1233} = (((\text{WattsBase}-\text{WattsEE})/1,000) * \text{ISR} * \text{Hours} * -\text{IFTherms}$$

Where:

IFTherms = Lighting-HVAC Interaction Factor for gas heating impacts; this factor represents the increased gas space heating requirements due to the reduction of waste heat rejected by the efficient lighting. Values are provided in the Reference Table in Section 4.5. If unknown, use the Miscellaneous value.

Other factors as defined above

¹²³²Negative value because this is an increase in heating consumption due to the efficient lighting.

¹²³³ Negative value because this is an increase in heating consumption due to the efficient lighting.

For example, delamping a 4 ft T8 fixture in an office building:

$$\begin{aligned}\Delta\text{Therms} &= ((19.4 - 0)/1,000) * 1.0 * 4439 * -0.016 \\ &= -1.4 \text{ therms}\end{aligned}$$

WATER IMPACT DESCRIPTIONS AND CALCULATION

N/A

DEEMED O&M COST ADJUSTMENT CALCULATION

N/A

MEASURE CODE: CI-LTG-DLMP-V03-210101

REVIEW DEADLINE: 1/1/2026

4.5.3 High Performance and Reduced Wattage T8 Fixtures and Lamps

DESCRIPTION

This measure applies to “High Performance T8” (HPT8) lamp/ballast systems that have higher lumens per watt than standard T8 systems. This measure applies to the installation of new equipment with efficiencies that exceed that of the equipment that would have been installed following standard market practices and is applicable to time of sale as well as retrofit measures. Retrofit measures may include new fixtures or relamp/reballast measures. In addition, options have been provided to allow for the “Reduced Wattage T8 lamps” or RWT8 lamps that result in relamping opportunities that produce equal or greater light levels than standard T8 lamps while using fewer watts.

If the implementation strategy does not allow for the installation location to be known, a deemed split of 100% Commercial and 0% Residential should be used.¹²³⁴

This measure was developed to be applicable to the following program types: TOS, EREP, DI.

If applied to other program types, the measure savings should be verified.

The measure applies to all commercial HPT8 installations excluding new construction and major renovation or change of use measures (see lighting power density measure). Lookup tables have been provided to account for the different types of installations. Whenever possible, actual costs and hours of use should be utilized for savings calculations. Default new and baseline assumptions have been provided in the reference tables. Default component costs and lifetimes have been provided for Operating and Maintenance Calculations. Please see the Definition Table to determine applicability for each program. HPT8 configurations not included in the TRM may be included in custom program design using the provided algorithms as long as energy savings is achieved. The following table defines the applicability for different programs:

Time of Sale (TOS)	Early Replacement (EREP) and Direct Install (DI)
<p>This measure relates to the installation of new equipment with efficiency that exceeds that of equipment that would have been installed following standard market practices. In general, the measure will include qualifying high efficiency low ballast factor ballasts paired with high efficiency long life lamps as detailed in the attached tables. High-bay applications use this system paired with qualifying high ballast factor ballasts and high performance 32 w lamps. Custom lighting designs can use qualifying low, normal or high ballast factor ballasts and qualifying lamps in lumen equivalent applications where total system wattage is reduced when calculated using the Calculation of Savings Algorithms.</p>	<p>This measure relates to the replacement of existing equipment with new equipment with efficiency that exceeds that of the existing equipment. In general, the retrofit will include qualifying high efficiency low ballast factor ballasts paired with high efficiency long life lamps as detailed in the attached tables. Custom lighting designs can use qualifying low, normal or high ballast factor ballasts and qualifying lamps in lumen equivalent applications where total system wattage is reduced when calculated using the Calculation of Savings Algorithms.</p> <p>High efficiency troffers (new/or retrofit) utilizing HPT8 technology can provide even greater savings. When used in a high-bay application, high-performance T8 fixtures can provide equal light to HID high-bay fixtures, while using fewer watts; these systems typically utilize high ballast factor ballasts, but qualifying low and normal ballast factor ballasts may be used when appropriate light levels are provided and overall wattage is reduced.</p>

¹²³⁴ Based on weighted average of Final ComEd’s Instant Discounts program data from PY7 and PY9. For Residential installations, hours of use assumptions from ‘5.5 Interior Hardwired Compact Fluorescent Lamp (CFL) Fixture’ measure should be used.

DEFINITION OF EFFICIENT EQUIPMENT

The efficient conditions for all applications are a qualifying HP or RWT8 fixture and lamp/ballast combinations listed on the CEE website under qualifying HP T8 products¹²³⁵ and qualifying RWT8 products.¹²³⁶

The definition of efficient equipment varies based on the program and is defined below:

Time of Sale (TOS)	Early Replacement (EREP) and Direct Install (DI)
<p>High efficiency troffers combined with high efficiency lamps and ballasts allow for fewer lamps to be used to provide a given lumen output. High efficiency troffers must have a fixture efficiency of 80% or greater to qualify. Default values are given for a 2 lamp HPT8 fixture replacing a 3 lamp standard efficiency T8 fixture, but other configurations may qualify and the Calculation of savings algorithm used to account for base watts being replaced with EE watts.</p> <p>High bay fixtures must have fixture efficiencies of 85% or greater.</p> <p>RWT8 lamps: 2', 3' and 8' lamps must meet the wattage requirements specified in the RWT8 new and baseline assumptions table. This measure assumes a lamp only purchase.</p>	<p>High efficiency troffers (new or retrofit kits) combined with high efficiency lamps and ballasts allow for fewer lamps to be used to provide a given lumen output. High efficiency troffers must have a fixture efficiency of 80% or greater to qualify. Default values are given for a 2 lamp HPT8 fixture replacing a 3 lamp standard efficiency T8 fixture, but other configurations may qualify and the Calculation of savings algorithm used to account for base watts being replaced with EE watts.</p> <p>High bay fixtures will have fixture efficiencies of 85% or greater.</p> <p>RWT8: 2', 3' and 8' lamps must meet the wattage requirements specified in the RWT8 new and baseline assumptions table.</p>

DEFINITION OF BASELINE EQUIPMENT

The definition of baseline equipment varies based on the program and is defined below:

Time of Sale (TOS)	Early Replacement (EREP) and Direct Install (DI)
<p>The baseline is standard efficiency T8 systems that would have been installed. The baseline for high-bay fixtures is pulse start metal halide fixtures, the baseline for a 2 lamp high efficiency troffer is a 3 lamp standard efficiency troffer.</p>	<p>The baseline is the existing system.</p> <p>In July 14, 2012, Federal Standards were enacted that were expected to eliminate T-12s as an option for linear fluorescent fixtures. Through v3.0 of the TRM, it was assumed that the T-12 would no longer be baseline for retrofits from 1/1/2016. However, due to significant loopholes in the legislation, T-12 compliant product is still freely available and in Illinois T-12s continue to hold a significant share of the existing and replacement lamp market. Therefore the timing of the sunseting of T-12s as a viable baseline has been pushed back and will be revisited in future update sessions.</p> <p>There will be a baseline shift applied to all early replacement measures with a T12 baseline. See table C-1.</p>

DEEMED LIFETIME OF EFFICIENT EQUIPMENT

The deemed lifetime of efficient equipment varies based on the program and is defined below:

¹²³⁵ Consortium for Energy Efficiency (CEE) Energy Efficiency Program Library, High-Performance T8 Specification, June 30, 2009.

¹²³⁶ Consortium for Energy Efficiency (CEE) Energy Efficiency Program Library, Reduced Wattage T8 Specification, July 29, 2013.

Time of Sale (TOS)	Early Replacement (EREP) and Direct Install (DI)
<p>Fixture lifetime is rated lifetime of fixture/hours of use. If unknown default is 12 years.¹²³⁷</p> <p>Fixture retrofits which utilize RWT8 lamps have a lifetime equivalent to the life of the lamp, capped at 15 years. There is no guarantee that a reduced wattage lamp will be installed at time of burnout, but if one is, savings will be captured in the RWT8 measure below.</p> <p>RWT8 lifetime is the life of the product, at the reported operating hours (lamp life in hours divided by operating hours per year – see reference table "RWT8 Component Costs and Lifetime"), capped at 12 years.¹²³⁸</p>	<p>Fixture lifetime is rated lifetime of fixture/hours of use. If unknown default is 15 years.</p> <p>As per explanation above, for existing T12 fixtures, a mid life baseline shift should be applied as described in table C-1. Note, since the fixture lifetime is deemed at 12 years, the replacement cost of both the lamp and ballast should be incorporated in to the O&M calculation.</p>

DEEMED MEASURE COST

The deemed measure cost is found in the reference table at the end of this characterization.

LOADSHAPE

- Loadshape C06 - Commercial Indoor Lighting
- Loadshape C07 - Grocery/Conv. Store Indoor Lighting
- Loadshape C08 - Hospital Indoor Lighting
- Loadshape C09 - Office Indoor Lighting
- Loadshape C10 - Restaurant Indoor Lighting
- Loadshape C11 - Retail Indoor Lighting
- Loadshape C12 - Warehouse Indoor Lighting
- Loadshape C13 - K-12 School Indoor Lighting
- Loadshape C14 - Indust. 1-shift (8/5) (e.g., comp. air, lights)
- Loadshape C15 - Indust. 2-shift (16/5) (e.g., comp. air, lights)
- Loadshape C16 - Indust. 3-shift (24/5) (e.g., comp. air, lights)
- Loadshape C17 - Indust. 4-shift (24/7) (e.g., comp. air, lights)
- Loadshape C18 - Industrial Indoor Lighting
- Loadshape C19 - Industrial Outdoor Lighting
- Loadshape C20 - Commercial Outdoor Lighting

Algorithm

CALCULATION OF SAVINGS

ELECTRIC ENERGY SAVINGS

$$\Delta kWh = ((Watt_{base} - Watt_{EE}) / 1000) * Hours * WHF_e * ISR$$

¹²³⁷ 12 years is based on average of mostly CEE lamp products (9 years), T5 lamps (10.7 years) and GDS Measure Life Report, June 2007, (15 years), as recommended in Navigant 'ComEd Effective Useful Life Research Report', May 2018.

¹²³⁸ ibid

Where:

Watts_{base} = Input wattage of the existing system which depends on the baseline fixture configuration (number and type of lamp) and number of fixtures. Value can be selected from the appropriate reference table as shown below, or a custom value can be entered if the configurations in the tables is not representative of the existing system.

Program	Reference Table
Time of Sale	A-1: HPT8 New and Baseline Assumptions
Early Replacement	A-2: HPT8 New and Baseline Assumptions
Reduced Wattage T8, time of sale or Early Replacement	A-3: RWT8 New and Baseline Assumptions

Watts_{EE} = New Input wattage of EE fixture which depends on new fixture configuration (number of lamps) and ballast factor and number of fixtures. Value can be selected from the appropriate reference table as shown below, or a custom value can be entered if the configurations in the tables is not representative of the existing system.

Program	Reference Table
Time of Sale	A-1: HPT8 New and Baseline Assumptions
Early Replacement	A-2: HPT8 New and Baseline Assumptions
Reduced Wattage T8, time of sale or Early Replacement	A-3: RWT8 New and Baseline Assumptions

Hours = Average hours of use per year as provided by the customer or selected from the Reference Table in Section 4.5, Fixture annual operating hours. If hours or building type are unknown, use the Miscellaneous value.

WHF_e = Waste heat factor for energy to account for cooling energy savings from efficient lighting is selected from the Reference Table in Section 4.5 for each building type. If building is un-cooled, the value is 1.0.

ISR = In Service Rate or the percentage of units rebated that get installed.
 =100% if application form completed with sign off that equipment is not placed into storage¹²³⁹

If sign off form not completed assume the following 3 year ISR assumptions:

Weighted Average 1st year In Service Rate (ISR)	2nd year Installations	3rd year Installations	Final Lifetime In Service Rate
93.4% ¹²⁴⁰	2.5%	2.1%	98.0% ¹²⁴¹

¹²³⁹ Illinois evaluation of PY1 through PY3 has not found that fixtures or lamps placed into storage to be a significant enough issue to warrant including an “In-Service Rate” when commercial customers complete an application form.

¹²⁴⁰ Based on ComEd’s Instant Incentives program data from PY7 and PY9, see “IL Commercial Lighting ISR_2018.xlsx”.

¹²⁴¹ The 98% Lifetime ISR assumption is based upon review of two evaluations:

‘Nexus Market Research, RLW Analytics and GDS Associates study; ‘New England Residential Lighting Markdown Impact Evaluation, January 20, 2009’ and ‘KEMA Inc, Feb 2010, Final Evaluation Report:, Upstream Lighting Program, Volume 1.’ This

HEATING PENALTY

If electrically heated building:

$$\Delta kWh_{\text{heatpenalty}}^{1242} = (((\text{WattsBase}-\text{WattsEE})/1000) * \text{ISR} * \text{Hours} * -\text{IFkWh}$$

Where:

IFkWh = Lighting-HVAC Interaction Factor for electric heating impacts; this factor represents the increased electric space heating requirements due to the reduction of waste heat rejected by the efficient lighting. Values are provided in the Reference Table in Section 4.5. If unknown, use the Miscellaneous value.

SUMMER COINCIDENT DEMAND SAVINGS

$$\Delta kW = ((\text{Watts}_{\text{base}}-\text{Watts}_{\text{EE}})/1000) * \text{WHF}_d * \text{CF} * \text{ISR}$$

Where:

WHF_d = Waste Heat Factor for Demand to account for cooling savings from efficient lighting in cooled buildings is selected from the Reference Table in Section 4.5 for each building type. If the building is not cooled WHF_d is 1.

CF = Summer Peak Coincidence Factor for measure is selected from the Reference Table in Section 4.5 for each building type. If the building type is unknown, use the Miscellaneous value of 0.66.

Other factors as defined above

FOSSIL FUEL SAVINGS

$$\Delta \text{Therms}^{1243} = (((\text{WattsBase}-\text{WattsEE})/1000) * \text{ISR} * \text{Hours} * -\text{IFTherms}$$

Where:

IFTherms = Lighting-HVAC Integration Factor for gas heating impacts; this factor represents the increased gas space heating requirements due to the reduction of waste heat rejected by the efficient lighting. Please select from the Reference Table in Section 4.5 for each building type.

WATER IMPACT DESCRIPTIONS AND CALCULATION

N/A

DEEMED O&M COST ADJUSTMENT CALCULATION

Actual operation and maintenance costs will vary by specific equipment installed/replaced. See Reference tables for Operating and Maintenance Values;

Program	Reference Table
Time of Sale	B-1: HPT8 Component Costs and Lifetime
Early Replacement	B-2: HPT8 Component Costs and Lifetime

implies that only 2% of bulbs purchased are never installed. The second and third year installations are based upon Ameren analysis of the Californian KEMA study showing that 54% of future installs occur in year 2 and 46% in year 3. The 2nd and 3rd year installations should be counted as part of those future program year savings. Note that this Final Install Rate does NOT account for leakage of purchased bulbs being installed outside of the utility territory. EM&V should assess how and if data from evaluation should adjust this final installation rate to account for this impact

¹²⁴²Negative value because this is an increase in heating consumption due to the efficient lighting.

¹²⁴³ Negative value because this is an increase in heating consumption due to the efficient lighting.

Program	Reference Table
Reduced Wattage T8, time of sale or Early Replacement	B-3: HPT8 Component Costs and Lifetime

REFERENCE TABLES

See following page

A-1: Time of Sale: HPT8 New and Baseline Assumptions¹²⁴⁴

EE Measure Description	Nominal Watts	Watts _{EE}	Baseline Description	Nominal Watt	Watts _{BASE}	Incremental Cost	Watts _{SAVE}
4-Lamp HPT8 w/ High-BF Ballast High-Bay	128	147.2	200 Watt Pulse Start Metal-Halide	200	232	\$75	84.80
4-Lamp HPT8 w/ High-BF Ballast High-Bay	128	147.2	250 Watt Metal Halide	250	295	\$75	147.80
6-Lamp HPT8 w/ High-BF Ballast High-Bay	192	220.8	320 Watt Pulse Start Metal-Halide	320	348.8	\$75	128.00
6-Lamp HPT8 w/ High-BF Ballast High-Bay	192	220.8	400 Watt Pulse Start Metal Halide	400	455	\$75	234.20
8-Lamp HPT8 w/ High-BF Ballast High-Bay	256	294.4	Proportionally Adjusted according to 6-Lamp HPT8 Equivalent to 320 PSMH	320	476	\$75	181.60
8-Lamp HPT8 w/ High-BF Ballast High-Bay	256	292.4	Proportionally Adjusted according to 6-Lamp HPT8 Equivalent to 400 W Metal Halide	400	618	75	323.60
1-Lamp HPT8-high performance 32 w lamp	32	24.64	1-Lamp Standard F32T8 w/ Elec. Ballast	32	28.16	\$15	3.52
1-Lamp HPT8-high performance 28 w lamp	28	21.56	1-Lamp Standard F32T8 w/ Elec. Ballast	32	28.16	\$15	6.60
1-Lamp HPT8-high performance 25 w lamp	25	19.25	1-Lamp Standard F32T8 w/ Elec. Ballast	32	28.16	\$15	8.91
2-Lamp HPT8 -high performance 32 w lamp	64	49.28	2-Lamp Standard F32T8 w/ Elec. Ballast	64	56.32	\$18	7.04
2-Lamp HPT8-high performance 28 w lamp	56	43.12	2-Lamp Standard F32T8 w/ Elec. Ballast	64	56.32	\$18	13.20
2-Lamp HPT8-high performance 25 w lamp	50	38.5	2-Lamp Standard F32T8 w/ Elec. Ballast	64	56.32	\$18	17.82
3-Lamp HPT8-high performance 32 w lamp	96	73.92	3-Lamp Standard F32T8 w/ Elec. Ballast	96	84.48	\$20	10.56
3-Lamp HPT8-high performance 28 w lamp	84	64.68	3-Lamp Standard F32T8 w/ Elec. Ballast	96	84.48	\$20	19.80
3-Lamp HPT8-high performance 25 w lamp	75	57.75	3-Lamp Standard F32T8 w/ Elec. Ballast	96	84.48	\$20	26.73
4-Lamp HPT8 -high performance 32 w lamp	128	98.56	4-Lamp Standard F32T8 w/ Elec. Ballast	128	112.64	\$23	14.08
4-Lamp HPT8-high performance 28 w lamp	112	86.24	4-Lamp Standard F32T8 w/ Elec. Ballast	128	112.64	\$23	26.40
4-Lamp HPT8-high performance 25 w lamp	100	77	4-Lamp Standard F32T8 w/ Elec. Ballast	128	112.64	\$23	35.64
2-lamp High-Performance HPT8 Troffer	64	49.28	3-Lamp F32T8 w/ Elec. Ballast	96	84.48	\$100	35.20

Table developed using a constant ballast factor of .77 for troffers/linear HPT8 and 1.15 for HPT8 highbay, 1.0 for all MH/MHPS, and 0.95 for T12 and 0.88 for standard T8. Input wattages are an average of manufacturer inputs that account for ballast efficacy

¹²⁴⁴ Watt, lumen, lamp life, and ballast factor assumptions for efficient measures are based upon Consortium for Energy Efficiency (CEE) Commercial Lighting Qualifying Product Lists. Watt, lumen, lamp life, and ballast factor assumptions for baseline fixtures are based upon manufacturer specification sheets. Baseline and efficient measure cost data comes from lighting suppliers, past Efficiency Vermont projects, and professional judgment.

A-2: Early Replacement HPT8 New and Baseline Assumptions¹²⁴⁵

EE Measure Description	Nominal Watts	Ballast Factor	Watts _{EE}	Baseline Description	Nominal Watts	Watts _{BASE}	Watts _{SAVE}	Full Measure Cost
4-Lamp HPT8 w/ High-BF Ballast High-Bay	128	1.15	147.2	200 Watt Pulse Start Metal-Halide	200	232	84.80	\$200
4-Lamp HPT8 w/ High-BF Ballast High-Bay	128	1.15	147.2	250 Watt Metal Halide	250	295	147.80	\$200
6-Lamp HPT8 w/ High-BF Ballast High-Bay	192	1.15	220.8	320 Watt Pulse Start Metal-Halide	320	348.8	128.00	\$225
6-Lamp HPT8 w/ High-BF Ballast High-Bay	192	1.15	220.8	400 Watt Pulse Start Metal Halide	400	455	234.20	\$225
8-Lamp HPT8 w/ High-BF Ballast High-Bay	256	1.15	294.4	Proportionally Adjusted according to 6-Lamp HPT8 Equivalent to 320 PSMH	320	476	181.60	\$250
8-Lamp HPT8 w/ High-BF Ballast High-Bay	256	1.15	294.4	Proportionally Adjusted according to 6-Lamp HPT8 Equivalent to 400 W Metal Halide	400	618	323.60	\$250
1-Lamp Relamp/Reballast T12 to HPT8	32	0.77	24.64	1-Lamp F34T12 w/ EEMag Ballast	34	42	17.36	\$50
2-Lamp Relamp/Reballast T12 to HPT8	64	0.77	49.28	2-Lamp F34T12 w/ EEMag Ballast	68	67	17.72	\$55
3-Lamp Relamp/Reballast T12 to HPT8	96	0.77	73.92	3-Lamp F34T12 w/ EEMag Ballast	102	104	30.08	\$60
4-Lamp Relamp/Reballast T12 to HPT8	128	0.77	98.56	4-Lamp F34T12 w/ EEMag Ballast	136	144	45.44	\$65
1-Lamp Relamp/Reballast T12 to HPT8	32	0.77	24.64	1-Lamp F40T12 w/ EEMag Ballast	40	41	16.36	\$50
2-Lamp Relamp/Reballast T12 to HPT8	64	0.77	49.28	2-Lamp F40T12 w/ EEMag Ballast	80	87	37.72	\$55
3-Lamp Relamp/Reballast T12 to HPT8	96	0.77	73.92	3-Lamp F40T12 w/ EEMag Ballast	120	141	67.08	\$60
4-Lamp Relamp/Reballast T12 to HPT8	128	0.77	98.56	4-Lamp F40T12 w/ EEMag Ballast	160	172	73.44	\$65
1-Lamp Relamp/Reballast T12 to HPT8	32	0.77	24.64	1-Lamp F40T12 w/ Mag Ballast	40	51	26.36	\$50
2-Lamp Relamp/Reballast T12 to HPT8	64	0.77	49.28	2-Lamp F40T12 w/ Mag Ballast	80	97	47.72	\$55
3-Lamp Relamp/Reballast T12 to HPT8	96	0.77	73.92	3-Lamp F40T12 w/ Mag Ballast	120	135	61.08	\$60
4-Lamp Relamp/Reballast T12 to HPT8	128	0.77	98.56	4-Lamp F40T12 w/ Mag Ballast	160	175	76.44	\$65
1-Lamp Relamp/Reballast T8 to HPT8	32	0.77	24.64	1-Lamp F32T8 w/ Elec. Ballast	32	28.16	3.52	\$50
2-Lamp Relamp/Reballast T8 to HPT8	64	0.77	49.28	2-Lamp F32T8 w/ Elec. Ballast	64	56.32	7.04	\$55
3-Lamp Relamp/Reballast T8 to HPT8	96	0.77	73.92	3-Lamp F32T8 w/ Elec. Ballast	96	84.48	10.56	\$60
4-Lamp Relamp/Reballast T8 to HPT8	128	0.77	98.56	4-Lamp F32T8 w/ Elec. Ballast	128	112.64	14.08	\$65

¹²⁴⁵ Watt, lumen, lamp life, and ballast factor assumptions for efficient measures are based upon Consortium for Energy Efficiency (CEE) Commercial Lighting Qualifying Product Lists. Watt, lumen, lamp life, and ballast factor assumptions for baseline fixtures are based upon manufacturer specification sheets. Baseline and efficient measure cost data comes from lighting suppliers, past Efficiency Vermont projects, Xcel Energy Lighting Efficiency Input Wattage Guide and professional judgment.

EE Measure Description	Nominal Watts	Ballast Factor	Watts _{EE}	Baseline Description	Nominal Watts	Watts _{BASE}	Watts _{SAVE}	Full Measure Cost
2-lamp High-Performance HPT8 Troffer or high efficiency retrofit troffer	64	0.77	49.28	3-Lamp F32T8 w/ Elec. Ballast	96	84.48	35.20	\$100

Table developed using a constant ballast factor of 0.77 for troffers/linear HPT8 and 1.15 for HPT8 highbay, 1.0 for all MH/MHPS, and 0.95 for T12 and 0.88 for standard T8. Input wattages are an average of manufacturer inputs that account for ballast efficacy.

EE Measure Description	Nominal Watts	Watt _{SEE}	EE Lamp Cost	Baseline Description	Base Lamp Cost	Nominal Watts	Watt _{SBASE}	Watt _{SAVE}	Measure Cost
RW T8 - F28T8 Lamp	28	24.64	\$4.50	F32 T8 Standard Lamp	\$2.50	32	28.16	3.52	\$2.00
RWT8 F2T8 Extra Life Lamp	28	24.64	\$4.50	F32 T8 Standard Lamp	\$2.50	32	28.16	3.52	\$2.00
RWT8 - F32/25W T8 Lamp	25	22.00	\$4.50	F32 T8 Standard Lamp	\$2.50	32	28.16	6.16	\$2.00
RWT8 - F32/25W T8 Lamp Extra Life	25	22.00	\$4.50	F32 T8 Standard Lamp	\$2.50	32	28.16	6.16	\$2.00
RWT8 F17T8 Lamp - 2 ft	16	14.08	\$4.80	F17 T8 Standard Lamp - 2ft	\$2.80	17	14.96	0.88	\$2.00
RWT8 F25T8 Lamp - 3 ft	23	20.24	\$5.10	F25 T8 Standard Lamp - 3ft	\$3.10	25	22.00	1.76	\$2.00
RWT8 F30T8 Lamp - 6' Utube	30	26.40	\$11.31	F32 T8 Standard Utube	\$9.31	32	28.16	1.76	\$2.00
RWT8 F29T8 Lamp - Utube	29	25.52	\$11.31	F32 T8 Standard Utube	\$9.31	32	28.16	2.64	\$2.00
RWT8 F96T8 Lamp - 8 ft	65	57.20	\$9.00	F96 T8 Standard Lamp - 8 ft	\$7.00	70	61.60	4.40	\$2.00

A- 3: RWT8 New and Baseline Assumptions

Table developed using a constant ballast factor of 0.88 for RWT8 and Standard T8.

B-1: Time of Sale T8 Component Costs and Lifetime¹²⁴⁶

¹²⁴⁶ Watt, lumen, lamp life, and ballast factor assumptions for efficient measures are based upon Consortium for Energy Efficiency (CEE) Commercial Lighting Qualifying Product Lists. Watt, lumen, lamp life, and ballast factor assumptions for baseline fixtures are based upon manufacturer specification sheets. Baseline and efficient measure cost data comes from lighting suppliers, past Efficiency Vermont projects, and professional judgment.

EE Measure Description	EE Lamp Cost	EE Lamp Life (hrs)	EE Lamp Rep. Labor Cost per lamp	EE Ballast Cost	EE Ballast Life (hrs)	EE Ballast Rep. Labor Cost	Baseline Description	Base Lamp Cost	Base Lamp Life (hrs)	Base Lamp Rep. Labor Cost	Base Ballast Cost	Base Ballast Life (hrs)	Base Ballast Rep. Labor Cost
4-Lamp HPT8 w/ High-BF Ballast High-Bay	\$5.00	24000	\$6.67	\$32.50	70000	\$15.00	200 Watt Pulse Start Metal-Halide	\$21.00	10000	\$6.67	\$87.75	40000	\$22.50
6-Lamp HPT8 w/ High-BF Ballast High-Bay	\$5.00	24000	\$6.67	\$32.50	70000	\$15.00	320 Watt Pulse Start Metal-Halide	\$21.00	20000	\$6.67	\$109.35	40000	\$22.50
8-Lamp HPT8 w/ High-BF Ballast High-Bay	\$5.00	24000	\$6.67	\$32.50	70000	\$15.00	Lamp HPT8 Equivalent to 320 PSMH	\$21.00	20000	\$6.67	\$109.35	40000	\$22.50
1-Lamp HPT8 – all qualifying lamps	\$5.00	24000	\$2.67	\$32.50	70000	\$15.00	1-Lamp Standard F32T12 w/ Elec Ballast	\$2.50	20000	\$2.67	\$15.00	70000	\$15.00
2-Lamp HPT8 – all qualifying lamps	\$5.00	24000	\$2.67	\$32.50	70000	\$15.00	2-Lamp Standard F32T12 w/ Elec Ballast	\$2.50	20000	\$2.67	\$15.00	70000	\$15.00
3-Lamp HPT8 – all qualifying lamps	\$5.00	24000	\$2.67	\$32.50	70000	\$15.00	3-Lamp Standard F32T8 w/ Elec. Ballast	\$2.50	20000	\$2.67	\$15.00	70000	\$15.00
4-Lamp HPT8 – all qualifying lamps	\$5.00	24000	\$2.67	\$32.50	70000	\$15.00	4-Lamp Standard F32T8 w/ Elec. Ballast	\$2.50	20000	\$2.67	\$15.00	70000	\$15.00
				\$32.50									
2-lamp High-Performance HPT8 Troffer	\$5.00	24000	\$2.67	\$32.50	70000	\$15.00	3-Lamp F32T8 w/ Elec. Ballast	\$2.50	20000	\$2.67	\$15.00	70000	\$15.00

B-2: T8 Early Replacement Component Costs and Lifetime¹²⁴⁷

¹²⁴⁷ Cost assumptions for baseline fixtures are based upon manufacturer specification sheets. Baseline and efficient measure cost data comes from lighting suppliers, past Efficiency Vermont projects, and professional judgment.

EE Measure Description	EE Lamp Cost	EE Lamp Life (hrs)	EE Lamp Rep. Labor Cost per lamp	EE Ballast Cost	EE Ballast Life (hrs)	EE Ballast Rep. Labor Cost	Baseline Description	Base Lamp Cost	Base Lamp Life (hrs)	Base Lamp Rep. Labor Cost	Base Ballast Cost	Base Ballast Life (hrs)	Base Ballast Rep. Labor Cost
4-Lamp HPT8 w/ High-BF Ballast High-Bay	\$5.00	24000	\$6.67	\$32.50	70000	\$15.00	200 Watt Pulse Start Metal-Halide	\$29.00	12000	\$6.67	\$87.75	40000	\$22.50
6-Lamp HPT8 w/ High-BF Ballast High-Bay	\$5.00	24000	\$6.67	\$32.50	70000	\$15.00	320 Watt Pulse Start Metal-Halide	\$72.00	20000	\$6.67	\$109.35	40000	\$22.50
8-Lamp HPT8 w/ High-BF Ballast High-Bay	\$5.00	24000	\$6.67	\$32.50	70000	\$15.00	Proportionally Adjusted according to 6-Lamp HPT8 Equivalent to 320 PSMH	\$17.00	20000	\$6.67	\$109.35	40000	\$22.50
1-Lamp Relamp/Reballast T12 to HPT8	\$5.00	24000	\$2.67	\$32.50	70000	\$15.00	1-Lamp F34T12 w/ EEMag Ballast	\$2.70	20000	\$2.67	\$20.00	40000	\$15.00
2-Lamp Relamp/Reballast T12 to HPT8	\$5.00	24000	\$2.67	\$32.50	70000	\$15.00	2-Lamp F34T12 w/ EEMag Ballast	\$2.70	20000	\$2.67	\$20.00	40000	\$15.00
3-Lamp Relamp/Reballast T12 to HPT8	\$5.00	24000	\$2.67	\$32.50	70000	\$15.00	3-Lamp F34T12 w/ EEMag Ballast	\$2.70	20000	\$2.67	\$20.00	40000	\$15.00
4-Lamp Relamp/Reballast T12 to HPT8	\$5.00	24000	\$2.67	\$32.50	70000	\$15.00	4-Lamp F34T12 w/ EEMag Ballast	\$2.70	20000	\$2.67	\$20.00	40000	\$15.00
1-Lamp Relamp/Reballast T8 to HPT8	\$5.00	24000	\$2.67	\$32.50	70000	\$15.00	1-Lamp F32T8 w/ Elec. Ballast	\$2.70	20000	\$2.67	\$20.00	70000	\$15.00
2-Lamp Relamp/Reballast T8 to HPT8	\$5.00	24000	\$2.67	\$32.50	70000	\$15.00	2-Lamp F32T8 w/ Elec. Ballast	\$2.70	20000	\$2.67	\$20.00	70000	\$15.00
3-Lamp Relamp/Reballast T8 to HPT8	\$5.00	24000	\$2.67	\$32.50	70000	\$15.00	3-Lamp F32T8 w/ Elec. Ballast	\$2.70	20000	\$2.67	\$20.00	70000	\$15.00
4-Lamp Relamp/Reballast T8 to HPT8	\$5.00	24000	\$2.67	\$32.50	70000	\$15.00	4-Lamp F32T8 w/ Elec. Ballast	\$2.70	20000	\$2.67	\$20.00	70000	\$15.00
2-lamp High-Performance HPT8 Troffer	\$5.00	24000	\$2.67	\$32.50	70000	\$15.00	3-Lamp F32T8 w/ Elec. Ballast	\$2.50	20000	\$2.67	\$15.00	70000	\$15.00

B-3: Reduced Wattage T8 Component Costs and Lifetime¹²⁴⁸

EE measure description	EE Lamp Cost	EE Lamp Life (hrs)	Baseline Description	Base Lamp Cost	Base Lamp Life (hrs)	Base Lamp Rep. Labor Cost
RW T8 - F28T8 Lamp	\$4.50	30000	F32 T8 Standard Lamp	\$2.50	15000	\$2.67
RWT8 F2T8 Extra Life Lamp	\$4.50	36000	F32 T8 Standard Lamp	\$2.50	15000	\$2.67
RWT8 - F32/25W T8 Lamp	\$4.50	30000	F32 T8 Standard Lamp	\$2.50	15000	\$2.67
RWT8 - F32/25W T8 Lamp Extra Life	\$4.50	36000	F32 T8 Standard Lamp	\$2.50	15000	\$2.67
RWT8 F17T8 Lamp - 2 ft	\$4.80	18000	F17 T8 Standard Lamp - 2ft	\$2.80	15000	\$2.67
RWT8 F25T8 Lamp - 3 ft	\$5.10	18000	F25 T8 Standard Lamp - 3ft	\$3.10	15000	\$2.67
RWT8 F30T8 Lamp - 6' Utube	\$11.31	24000	F32 T8 Standard Utube	\$9.31	15000	\$2.67
RWT8 F29T8 Lamp - Utube	\$11.31	24000	F32 T8 Standard Utube	\$9.31	15000	\$2.67
RWT8 F96T8 Lamp - 8 ft	\$9.00	24000	F96 T8 Standard Lamp - 8 ft	\$7.00	15000	\$2.67

¹²⁴⁸ Cost assumptions for baseline fixtures are based upon manufacturer specification sheets. Baseline and efficient measure cost data comes from lighting suppliers, past Efficiency Vermont projects, and professional judgment.

C-1: T12 Baseline Adjustment:

For early replacement measures replacing existing T12 fixtures the full savings (as calculated above in the Algorithm section) will be claimed for the remaining useful life of the T12 fixture. This should be calculated as follows:

$$\text{RUL of existing T12 fixture} = (1/3 * 40,000)/\text{Hours}$$

A savings adjustment should then be applied to the annual savings for the remainder of the measure life. The adjustment to be applied for each measure should be calculated as:

$$\% \text{ Adjustment} = (\text{TOS Base Watts} - \text{Efficient Watts}) / (\text{Existing T12 Watts} - \text{Efficient Watts})$$

For example, an existing 2 lamp T12 fixture (87W) in a college is replaced by a 2 lamp HPT8 (49.3W).

$$\text{Mid life adjustment of } (56.4 - 49.3) / (87 - 49.3) = 19\%$$

$$\text{Applied after } (1/3 * 40000) / 3395 = 3.9 \text{ years}$$

The adjustment to be applied for each default measure described above is listed in the reference table below:

Savings Adjustment Factors

EE Measure Description	Savings Adjustment T12 EEmag ballast and 34 w lamps to HPT8	Savings Adjustment T12 EEmag ballast and 40 w lamps to HPT8	Savings Adjustment T12 mag ballast and 40 w lamps to HPT8
1-Lamp Relamp/Reballast T12 to HPT8	20%	22%	13%
2-Lamp Relamp/Reballast T12 to HPT8	40%	19%	15%
3-Lamp Relamp/Reballast T12 to HPT8	35%	16%	17%
4-Lamp Relamp/Reballast T12 to HPT8	31%	19%	18%

MEASURE CODE: CI-LTG-T8FX-V09-200101

REVIEW DEADLINE: 1/1/2025

4.5.4 LED Bulbs and Fixtures

DESCRIPTION

Please note that this measure characterization contains assumptions that were negotiated as a compromise between the utilities and stakeholders. The Parties agree that from TRM version 11 does not allow utilities to claim General Service Lamp measure savings for business customers with longer than a 2 year measure life; though the Parties recognize that small businesses, disadvantaged businesses and non-profit entities often face challenges similar to Income Qualified customers.

This characterization provides savings assumptions for a variety of LED lamps including Omnidirectional (e.g., A-Type lamps), Decorative (e.g., Globes and Torpedoes), Directional (PAR Lamps, Reflectors, MR16), Mogul (E39, EX39), TLEDs and fixtures including refrigerated case, recessed and outdoor/garage fixtures.

If the implementation strategy does not allow for the installation location to be known, 100% Commercial targeted programs and 0% Residential targeted programs for LED Fixtures, Mogul LEDs and TLEDs should be used.¹²⁴⁹

This measure was developed to be applicable to the following program types: TOS, NC, EREP, DI, KITS.

If applied to other program types, the measure savings should be verified.

DEFINITION OF EFFICIENT EQUIPMENT

In order for this characterization to apply, new lamps must be ENERGY STAR in accordance with ENERGY STAR specification v2.1 (effective 1/2/2017) or equivalent to the most recent version of ENERGY STAR specifications or be listed on the Design Lights Consortium Qualifying Product List.¹²⁵⁰

DEFINITION OF BASELINE EQUIPMENT

The Standard Rx Program will assume a Time of Sale baseline for all one to one replacements, and early replacement for lighting redesign and early retirement for delamping.

For early replacement, the baseline is the existing fixture being replaced.

If the existing fixture is a T12: In July 14, 2012, Federal Standards were enacted that were expected to eliminate T-12s as an option for linear fluorescent fixtures. Through v3.0 of the TRM, it was assumed that the T-12 would no longer be baseline for retrofits from 1/1/2016. However, due to significant loopholes in the legislation, T-12 compliant product is still freely available and in Illinois T-12s continue to hold a significant share of the existing and replacement lamp market. From v8.0 on, a midlife adjustment is applied after the remaining useful life of the T12 fixture (calculated as 1/3 of the 40,000 hour ballast life/ hours). This assumes that T12 replacement lamps will continue to be available until then. See 'Early Replacement Measures with T12 baseline' section.

For Time of Sale, refer to the baseline tables at the end of this measure.

In 2012, Federal legislation stemming from the Energy Independence and Security Act of 2007 (EIAS) required all general-purpose light bulbs (defined as omni-directional or standard A-lamps) between 40 watts and 100 watts to have ~30% increased efficiency, essentially phasing out standard incandescent technology. In 2012, the 100 w lamp standards went in to effect followed by the 75 w lamp standards in 2013 and 60 w and 40 w lamps in 2014.

Additionally, an EISA backstop provision was included that would require replacement baseline lamps to meet an efficacy requirement of 45 lumens/watt or higher beginning on 1/1/2020.

However, in December 2019, DOE issued a final determination for General Service Incandescent Lamps (GSILs), finding that this more stringent standard was not economically justified. However, in May 2022 DOE reversed this decision by issuing a Final rule for both the broadened General Service Lamp definition as well as the implementation

¹²⁴⁹ Based on ComEd's Instant Discounts program CY2018, CY2019 and CY2020 (Rounds 1 and 2) Purchaser Survey analysis. See ComEd Instant Discounts Enduser Survey TRM Updates.xlsx. For Residential installations, hours of use assumptions from '5.5.6 LED Downlights' should be used for LED fixtures and '5.5.8 LED Screw Based Omnidirectional Bulbs' should be used for LED bulbs.

¹²⁵⁰ ENERGY STAR Program Requirements Product Specifications for Lamps (Light Bulbs), version 2.1, effective January 2, 2017.

of the 45 lumen per watt backstop. DOE stated that it will use its enforcement discretion to minimize impacts on the supply chain and effectively allow companies to continue the manufacture and import of noncompliant bulbs through the remainder of 2022, and allow retailers to continue selling them with limited enforcement until July 2023.

As of 6/30/2023, no savings are claimed for screw based LED lamps or ENERGY STAR fixtures due to the EISA backstop unless installed in IQ common areas or via direct install programs. Direct Install programs where it can be shown that the LED is replacing working inefficient lighting should continue to use the existing inefficient lighting as baseline and also assume a measure life of 2 years.

DEEMED LIFETIME OF EFFICIENT EQUIPMENT

For interior fixtures, and Mogul LEDs, the lifetime is the life of the product, at the reported operating hours (lamp life in hours divided by operating hours per year – see reference table "LED component Costs and Lifetime." The analysis period is the same as the lifetime, capped at 15 years. (15 years from GDS Measure Life Report, June 2007).

For exterior fixtures, the lifetime is assumed to be 16 years for Dusk-to-Dawn (4303 hours) applications, or 25 years for Dusk-to-Business-Close Year Round (1609 hours) and Dusk-to-Business-Close Seasonal (<1000 hours).¹²⁵¹

For lamps and LED Downlight Fixtures with a baseline impacted by the EISA backstop as indicated in tables below the measure life is assumed to be two years for direct install programs, unless installed in income qualified locations such as IQ common area lighting where a lifetime of 8 years should be used consistent with the residential measure assumption.

For lamps not impacted by the EISA backstop, the lifetime is calculated as the rated lifetime of the product (actual if available, otherwise assume 20,000 hours for Omnidirectional, 17,000 hours for decorative and 25,000 for directional lamps based on average rated life of lamps on the ENERGY STAR Qualified Products list (accessed 6/16/2020)) divided by the reported operating hours, capped at 10 years.¹²⁵²

DEEMED MEASURE COST

Wherever possible, actual incremental costs should be used. Refer to reference table "LED component Cost & Lifetime" for defaults.

LOADSHAPE

- Loadshape C06 - Commercial Indoor Lighting
- Loadshape C07 - Grocery/Conv. Store Indoor Lighting
- Loadshape C08 - Hospital Indoor Lighting
- Loadshape C09 - Office Indoor Lighting
- Loadshape C10 - Restaurant Indoor Lighting
- Loadshape C11 - Retail Indoor Lighting
- Loadshape C12 - Warehouse Indoor Lighting
- Loadshape C13 - K-12 School Indoor Lighting
- Loadshape C14 - Indust. 1-shift (8/5) (e.g., comp. air, lights)
- Loadshape C15 - Indust. 2-shift (16/5) (e.g., comp. air, lights)
- Loadshape C16 - Indust. 3-shift (24/5) (e.g., comp. air, lights)
- Loadshape C17 - Indust. 4-shift (24/7) (e.g., comp. air, lights)
- Loadshape C18 - Industrial Indoor Lighting

¹²⁵¹ Exterior fixture measure lives are based upon review of the typical rated life of the fixtures, divided by the hours of use assumption and applying a derating factor of 15% to account for potential impacts from external installation (as proposed in a Guidehouse EUL methodology recommendation for Street Lights).

¹²⁵² Based on recommendation in the Dunsy Energy Consulting, Livingston Energy Innovations and Opinion Dynamics Corporation; NEEP Emerging Technology Research Report, p 6-18.

- Loadshape C19 - Industrial Outdoor Lighting
- Loadshape C20 - Commercial Outdoor Lighting
- Loadshape C60 – Non-Residential Agriculture Lighting – 6 Hours
- Loadshape C61 – Non-Residential Agriculture Lighting – 8 Hours
- Loadshape C62 – Non-Residential Agriculture Lighting – 12 Hours
- Loadshape C63 – Non-Residential Dairy Long Day Lighting – 17 Hours
- Loadshape C64 – Non-Residential Agriculture Lighting – 24 Hours

COINCIDENCE FACTOR

The summer peak coincidence factor for this measure is dependent on the location type. Values are provided for each building type in the reference section below.

Algorithm

CALCULATION OF SAVINGS

ELECTRIC ENERGY SAVINGS

$$\Delta kWh = ((Watts_{base} - Watts_{EE}) / 1,000) * Hours * WHF_e * ISR * (1 - Leakage)$$

Where:

Watts_{base} = Input wattage of the existing (for early replacement) or baseline system. Reference the “LED New and Baseline Assumptions” table for default values.

Watts_{EE} = Actual wattage of LED purchased / installed. If unknown, use default provided below:
 For ENERGY STAR rated lamps the following lumen equivalence tables should be used:¹²⁵³

Omnidirectional Lamps - ENERGY STAR Minimum Luminous Efficacy = 80Lm/W for <90 CRI lamps and 70Lm/W for >=90 CRI lamps.

Minimum Lumens	Maximum Lumens	LED Wattage (WattsEE)	Baseline (WattsBase)	Delta Watts (WattsEE)	Impacted by EISA Backstop
120	309	4.0	25	21.0	No
310	399	4.0	25	21.0	Yes
400	749	6.6	29	22.4	Yes
750	899	9.6	43	33.4	Yes
900	1,399	13.1	53	39.9	Yes
1,400	1,999	16.0	72	56.0	Yes
2,000	2,999	21.8	150	128.2	Yes
3,000	3,299	28.9	200	171.1	Yes
3,300	3,999	28.9	200	171.1	No
4,000	5,000	35.7	300	264.3	No

¹²⁵³ See file “LED Lamp Updates 2021-06-09” for details on Guidehouse lamp wattage calculations based on equivalent baseline wattage and LED wattage of available ENERGY STAR product

Decorative Lamps - ENERGY STAR Minimum Luminous Efficacy = 65Lm/W for all lamps

Bulb Type	Minimum Lumens	Maximum Lumens	LED Wattage (Watts _{SE})	Baseline (Watts _{Base})	Delta Watts (Watts _{EE})	Impacted by EISA Backstop
Omni-Directional 3-Way	1,100	1,999	14.7	100	85.3	Yes
	2,000	2,700	22.6	150	127.4	Yes
Globe (medium and intermediate bases less than 750 lumens)	150	309	3.0	25	22	No
	310	349	3.0	25	22	Yes
	350	499	4.7	40	35.3	Yes
	500	574	5.7	60	54.3	Yes
	575	649	6.5	75	68.5	Yes
	650	1,000	8.2	100	91.8	Yes
Globe (candelabra bases less than 1050 lumens)	150	309	3.5	25	21.5	No
	310	349	3.5	25	21.5	Yes
	350	499	4.4	40	35.6	Yes
	500	574	5.5	60	54.5	Yes
Decorative (Shapes B, BA, C, CA, DC, F, G, medium and intermediate bases less than 750 lumens)	160	299	2.6	25	22.4	No
	300	309	4.3	40	35.7	No
	310	499	4.3	40	35.7	Yes
						Yes
	500	800	5.8	60	54.2	
Decorative (Shapes B, BA, C, CA, DC, F, G, T candelabra bases less than 1050 lumens)	120	159	1.5	15	13.5	No
	160	299	2.7	25	22.3	No
	300	309	4.2	40	35.8	No
	310	499	4.2	40	35.8	Yes
	500	650	5.5	60	54.5	Yes
Decorative (Shape ST)	250	309	6.5	40	33.5	No
	310	499	6.5	40	33.5	Yes
	500	999	8.8	60	51.2	Yes
	1000	1500	10.0	100	90.0	Yes
Decorative (Shape S)	50	75	1.0	11	10.0	No
	100	120	1.2	15	13.8	No
	120	309	2.25	25	22.8	No
	310	340	2.25	25	22.8	Yes

Directional Lamps - ENERGY STAR Minimum Luminous Efficacy = 70Lm/W for <90 CRI lamps and 61 Lm/W for >=90CRI lamps.

For Directional R, BR, ER, PAR, MR and MRX lamp types. Note the Center Beam Candle Power (CBCP) methodology described below the default table is the preferred methodology for PAR, MR and MRX lamps and should be used where data allows. Defaults for use when this information is not available are provided below:

Bulb Type	Minimum Lumens	Maximum Lumens	LED Wattage (Watts _{EE})	Baseline (Watts _{Base})	Delta Watts (Watts _{EE})	Impacted by EISA Backstop
Reflector lamp types with medium screw bases (PAR20, PAR30(S,L), PAR38, R40, etc.) w/ diameter >2.25" (*see exceptions below)	400	649	7.0	50	43	Yes
	650	899	10.7	75	64.3	Yes
	900	1,049	13.9	90	76.1	Yes
	1,050	1,199	13.8	100	86.2	Yes
	1,200	1,499	15.9	120	104.1	Yes
	1,500	1,999	18.9	150	131.1	Yes
	2,000	3,299	27.3	250	222.7	Yes
	3,300	4,200	27.3	250	222.7	No
Reflector lamp types with medium screw bases (PAR16, R14, R16, etc.) w/ diameter <2.25" (*see exceptions below)	280	309	4.6	35	30.4	No
	310	374	4.6	35	30.4	Yes
	375	600	6.4	50	43.6	Yes
*BR30, BR40, or ER40	650	949	9.3	65	55.7	Yes
	950	1,099	12.7	75	62.3	Yes
	1,100	1,399	14.4	85	70.6	Yes
	1,400	1,600	16.6	100	83.4	Yes
	1,601	1,800	22.2	120	97.8	Yes
*R20	450	524	6.0	40	34.0	Yes
	525	750	7.1	45	37.9	Yes
*MR16	250	309	3.8	20.0	16.2	No
	310	324	3.8	20.0	16.2	Yes
	325	369	4.8	25.0	20.2	Yes
	370	400	4.9	25.0	20.1	Yes

For PAR, MR, and MRX Lamps Types:

For these highly focused directional lamp types, it is necessary to have Center Beam Candle Power (CBCP) and beam angle measurements to accurately estimate the equivalent baseline wattage. The formula below is based on the Energy Star Center Beam Candle Power tool.¹²⁵⁴ If CBCP and beam angle information are not available or if the equation below returns a negative value (or undefined), use the manufacturer’s recommended baseline wattage equivalent.¹²⁵⁵

Wattsbase =

$$375.1 - 4.355(D) - \sqrt{227,800 - 937.9(D) - 0.9903(D^2) - 1479(BA) - 12.02(D * BA) + 14.69(BA^2) - 16,720 * \ln(CBCP)}$$

Where:

D = Bulb diameter (e.g. for PAR20 D = 20)

BA = Beam angle

¹²⁵⁴ ENERGY STAR Lamps Center Beam Intensity Benchmark Tool and Calculator

¹²⁵⁵ The Energy Star Center Beam Candle Power tool does not accurately model baseline wattages for lamps with certain bulb characteristic combinations – specifically for lamps with very high CBCP.

CBCP = Center beam candle power

The result of the equation above should be rounded DOWN to the nearest wattage established by Energy Star:

Diameter	Permitted Wattages
16	20, 35, 40, 45, 50, 60, 75
20	50
30S	40, 45, 50, 60, 75
30L	50, 75
38	40, 45, 50, 55, 60, 65, 75, 85, 90, 100, 120, 150, 250

Additional bulb types:

Bulb Type	Minimum Lumens	Maximum Lumens	LED Wattage (Watts _{EE})	Baseline (Watts _{Base})	Delta Watts (Watts _{EE})	Impacted by EISA Backstop
Dimmable Twist, Globe (less than 5" in diameter and > 749 lumens), candle (shapes B, BA, CA > 749 lumens), Candelabra Base Lamps (>1049 lumens), Intermediate Base Lamps (>749 lumens)	120	309	4.0	25	21.0	No
	310	399	4.0	25	21.0	Yes
	400	749	6.6	29	22.4	Yes
	750	899	9.6	43	33.4	Yes
	900	1,399	13.1	53	39.9	Yes
	1,400	1,999	16.0	72	56.0	Yes

Hours = Average hours of use per year are provided in the Reference Table in Section 4.5 for each building type. For Mogul LEDs, use fixture annual operating hours. If unknown, use the Miscellaneous value.

WHFe = Waste heat factor for energy to account for cooling energy savings from efficient lighting are provided below for each building type in the Reference Table in Section 4.5. If unknown, use the Miscellaneous value.

ISR = In Service Rate -the percentage of units rebated that actually get installed.
 =100% if application form completed with sign off that equipment is not placed into storage.¹²⁵⁶ If sign off form not completed, assume the following ISR assumptions, if program survey data is not available:

¹²⁵⁶ Illinois evaluation of PY1 through PY3 has not found that fixtures or lamps placed into storage to be a significant enough issue to warrant including an "In-Service Rate" when commercial customers complete an application form.

Type	1st year In Service Rate (ISR) ¹²⁵⁷
LED Bulbs	97.9% ¹²⁵⁸
Mogul LEDs	97.9% ¹²⁵⁹
LED Fixtures (Energy Star Fixtures)	98.0% ¹²⁶⁰
Efficiency Kits	92.9% ¹²⁶¹

Type	Weighted Average 1st year In Service Rate (ISR)	2nd year Installations	3rd year Installations	Final Lifetime In Service Rate
TLEDs	83.1% ¹²⁶²	8.1%	6.8%	98.0%

Leakage = Adjustment to account for the percentage of program bulbs that move out (and in if deemed appropriate)¹²⁶³ of the Utility Jurisdiction.

Midstream (TOS) Lighting programs = Use deemed assumptions below:¹²⁶⁴

ComEd: 0.31%

Ameren: 0%¹²⁶⁵

All other programs = 0%

¹²⁵⁷ In Service Rates now represent the lifetime In Service Rates with the second and third year installations discounted by the Real Discount Rate of 0.46%. Lifetime ISR assumptions for efficiency kits are based upon Residential direct mailed kits. For all other programs the 98% Lifetime ISR assumption is based upon the standard CFL measure in the absence of any better reference. This value is based upon review of two evaluations:

‘Nexus Market Research, RLW Analytics and GDS Associates study; ‘New England Residential Lighting Markdown Impact Evaluation, January 20, 2009’ and ‘KEMA Inc, Feb 2010, Final Evaluation Report: Upstream Lighting Program, Volume 1.’ This implies that only 2% of bulbs purchased are never installed. The second and third year installations are based upon Ameren analysis of the Californian KEMA study showing that 54% of future installs occur in year 2 and 46% in year 3.

¹²⁵⁸ Based on ComEd’s Instant Discounts program CY2019 and CY2020 (Rounds 1 and 2) Purchaser Survey analysis. See ComEd Instant Discounts Enduser Survey TRM Updates.xlsx

¹²⁵⁹ Based on survey data from participants in AIC’s 2022 Midstream Lighting channel. See AIC Midstream Lighting – Mogul ISR Calculations.xlsx

¹²⁶⁰ Based on ComEd’s Instant Discounts program CY2019 and CY2020 (Rounds 1 and 2) Purchaser Survey analysis. See ComEd Instant Discounts Enduser Survey TRM Updates.xlsx

¹²⁶¹ First year ISR is average ISR from CY2018, CY2019 and CY2020 ComEd Small Business Kit participant installation surveys. Please see file “SB Kits Survey Analysis TRMv10 Support.xlsx”

¹²⁶² Based on ComEd’s Instant Discounts program CY2019 and CY2020 (Rounds 1 and 2) Purchaser Survey analysis. See ComEd Instant Discounts Enduser Survey TRM Updates.xlsx

¹²⁶³ Leakage in is only appropriate to credit to IL utility program savings if it is reasonably expected that the IL utility program marketing efforts played an important role in influencing customer to purchase the light bulbs. Furthermore, consideration that such customers might be free riders should be addressed. If leakage in is assessed, efforts should be made to ensure no double counting of savings occurs if the evaluation is estimating both leakage in and spillover savings of light bulbs.

¹²⁶⁴ Leakage rate is based upon review of PY9-CY2021 evaluations from ComEd.

¹²⁶⁵ Per Ameren staff, all incentivized non-residential LED bulbs and fixtures are required to show proof of being an Ameren customer and thus the leakage is 0%.

Mid Life Baseline Adjustment

Early Replacement Measures with T12 Baseline

For early replacement measures replacing existing T12 fixtures the full savings (as calculated above in the Algorithm section) will be claimed for the remaining useful life of the T12 fixture. This should be calculated as follows:

$$\text{RUL of existing T12 fixture} = (1/3 * 40,000)/\text{Hours}$$

A savings adjustment should then be applied to the annual savings for the remainder of the measure life. The adjustment factor to be applied for each T12 installation is 57%.¹²⁶⁶

For example, for an existing 68W T12 fixture in a college is replaced by a 3000 lumen LED 2x2 Recessed Light Fixture (25.4W), a mid life adjustment of 57% should be applied after $(1/3 * 40000)/3395 = 3.9$ years.

HEATING PENALTY

If electrically heated building:

$$\Delta\text{kWh}_{\text{heatpenalty}}^{1267} = (((\text{WattsBase}-\text{WattsEE})/1000) * \text{ISR} * \text{Hours} * -\text{IFkWh})$$

Where:

IFkWh = Lighting-HVAC Interaction Factor for electric heating impacts; this factor represents the increased electric space heating requirements due to the reduction of waste heat rejected by the efficient lighting. Values are provided in the Reference Table in Section 4.5. If unknown, use the Miscellaneous value.

For example, a 9W LED omnidirectional lamp, 450 lumens, is installed in a heat pump heated mid rise office and sign off form provided:

$$\begin{aligned} \Delta\text{kWh}_{\text{heatpenalty}} &= ((29-6.7)/1,000)*1.0*3088* -0.164 \\ &= - 11.3 \text{ kWh} \end{aligned}$$

DEFERRED INSTALLS

As presented above, if a sign off form is not completed the characterization assumes that a percentage of T-LED bulbs purchased are not installed until Year 2 and Year 3 (see ISR assumption above). The Illinois Technical Advisory Committee has determined the following methodology for calculating the savings of these future installs.

Year 1 (Purchase Year) installs: Characterized using assumptions provided above or evaluated assumptions if available.

Year 2 and 3 installs: Characterized using delta watts assumption and hours of use from the Install Year, i.e., the actual deemed (or evaluated if available) assumptions active in Year 2 and 3 should be applied.

The NTG factor for the Purchase Year should be applied.

¹²⁶⁶ The appropriate T12 midlife adjustment factor was developed by the TAC Lighting Working Group. The results of a 2019 ComEd study provided survey response data on the planned replacement upon the burnout of a T12 ballast. This was adjusted by first year NTG to remove first year freeriders and therefore estimate what the non-freerider population would do at the end of T12 life. See “Linear Forecast Workbook_2020.xls” for information on calculation.

¹²⁶⁷Negative value because this is an increase in heating consumption due to the efficient lighting.

SUMMER COINCIDENT PEAK DEMAND SAVINGS

$$\Delta kW = ((Watts_{base} - Watts_{EE}) / 1,000) * ISR * WHF_d * CF$$

Where:

WHF_d = Waste Heat Factor for Demand to account for cooling savings from efficient lighting in cooled buildings is provided in Reference Table in Section 4.5. If unknown, use the Miscellaneous value.

CF = Summer Peak Coincidence Factor for measure is provided in the Reference Table in Section 4.5. If unknown, use the Miscellaneous value.

For example, a 9W LED omnidirectional lamp, 450 lumens, is installed in a mid rise office and sign off form provided:

$$\begin{aligned} \Delta kW &= ((29 - 6.7) / 1,000) * 1.0 * 1.3 * 0.6 \\ &= 0.017 \text{ kW} \end{aligned}$$

FOSSIL FUEL SAVINGS

Heating Penalty if fossil fuel heated building (or if heating fuel is unknown):

$$\Delta Therms = ((Watts_{Base} - Watts_{EE}) / 1000) * ISR * Hours * - IFTherms$$

Where:

IFTherms = Lighting-HVAC Integration Factor for gas heating impacts; this factor represents the increased gas space heating requirements due to the reduction of waste heat rejected by the efficient lighting. Values are provided in the Reference Table in Section 4.5. If unknown, use the Miscellaneous value.

For example, a 9W LED omnidirectional lamp, 450 lumens, is installed in a mid rise office and sign off form provided:

$$\begin{aligned} \Delta Therms &= ((29 - 6.7) / 1,000) * 1.0 * 3088 * -0.016 \\ &= - 1.10 \text{ therms} \end{aligned}$$

WATER IMPACT DESCRIPTIONS AND CALCULATION

N/A

DEEMED O&M COST ADJUSTMENT CALCULATION

For fixture measures, the individual component lifetimes and costs are provided in the reference table section below.¹²⁶⁸

For lamps no O&M costs should be applied.

REFERENCE TABLES

LED Bulb Assumptions

Wherever possible, actual incremental costs should be used. If unavailable assume the following incremental costs:¹²⁶⁹

¹²⁶⁸ See IL LED Lighting Systems TRM Reference Tables_2018.xlsx for breakdown of component cost assumptions.

¹²⁶⁹ Baseline and LED lamp costs are based on field data collected by CLEAResult and provided by ComEd. See ComEd Pricing Projections 06302016.xlsx for analysis. Given LED prices are expected to continue declining assumed costs should be reassessed on an annual basis and replaced with IL specific LED program information when available.

Bulb Type	Year	LED	Incandescent	Incremental Cost
Omnidirectional	2017	\$3.21	\$1.25	\$1.96
	2018	\$3.21		\$1.96
	2019	\$3.11		\$1.86
	2020	\$2.70		\$1.45
Directional	2017	\$6.24	\$3.53	\$2.71
	2018+	\$5.18		\$1.65
Decorative and Globe	2017	\$3.50	\$1.60	\$1.90
	2018+	\$3.40	\$1.74	\$1.66

LED Fixture Wattage, TOS Baseline and Incremental Cost Assumptions¹²⁷⁰

LED Category	EE Measure Description	Watts _{EE}	Baseline Description	Watts _{BASE}	Incremental Cost
LED Downlight Fixtures* Impacted by EISA Backstop – apply 2 year measure life (or 8 years if IQ)	LED Recessed, Surface, Pendant Downlights	17.6	Baseline Recessed, Surface, Pendant Downlights	54.3	\$27
LED Interior Directional	LED Track Lighting	12.2	Baseline Track Lighting	60.4	\$59
	LED Wall-Wash Fixtures	8.3	Baseline Wall-Wash Fixtures	17.7	\$59
LED Display Case ¹²⁷¹	LED Display Case Light Fixture	4 per ft	Baseline Display Case Light Fixture	36.2 per ft	\$11/ft
	LED Undercabinet Shelf-Mounted Task Light Fixtures	4 per ft	Baseline Undercabinet Shelf-Mounted Task Light Fixtures	36.2 per ft	\$11/ft
	LED Refrigerated Case Light, Horizontal or Vertical	4 per ft	Baseline Refrigerated Case Light, Horizontal or Vertical (per foot)	15.2 per ft	\$11/ft
	LED Freezer Case Light, Horizontal or Vertical	4 per ft	Baseline Freezer Case Light, Horizontal or Vertical (per foot)	18.7 per ft	\$11/ft
LED Linear Replacement Lamps	T8 LED Replacement Lamp (TLED), < 1200 lumens	8.6	F17T8 Standard Lamp - 2 foot	15.0	\$13

¹²⁷⁰ Watt assumptions for efficient measures are based upon the average wattage of each fixture type/lumen range from the Design Light Consortium (DLC) Qualifying Product Lists alongside past Efficiency Vermont projects and PGE refrigerated case study. Watt, lumen, lamp life, and ballast factor assumptions for baseline fixtures are based upon manufacturer specification sheets. Baseline cost data comes from lighting suppliers, past Efficiency Vermont projects, and professional judgment. Efficient cost data comes from 2012 DOE “Energy Savings Potential of Solid-State Lighting in General Illumination Applications”, Table A.1. See “LED Lighting Systems TRM Reference Tables_2018.xlsx” for more information and specific product links.

¹²⁷¹ LED Case Lighting is based on an average of DLC Horizontal and Vertical Lighting less than 80 W. This filter was intended to exclude vaportight fixtures from the average. The horizontal and vertical averages, provided by Guidehouse in 5/2020, were 4.1 W/ft and 3.7 W/ft, respectively.

LED Category	EE Measure Description	Watts _{EE}	Baseline Description	Watts _{BASE}	Incremental Cost
	T8 LED Replacement Lamp (TLED), 1200-2400 lumens	13.7	F32T8 Standard Lamp - 4 foot	28.2	\$15
	T8 LED Replacement Lamp (TLED), > 2400 lumens	24.7	F32T8/HO Standard Lamp - 4 foot	41.8	\$13
LED Troffers	LED 2x2 Recessed Light Fixture, 2000-3500 lumens	22.4	2-Lamp 32w T8 (BF < 0.89)	57.0	\$53
	LED 2x2 Recessed Light Fixture, 3501-5000 lumens	34.2	3-Lamp 32w T8 (BF < 0.88)	84.5	\$69
	LED 2x4 Recessed Light Fixture, 3000-4500 lumens	29.9	2-Lamp 32w T8 (BF < 0.89)	57.0	\$55
	LED 2x4 Recessed Light Fixture, 4501-6000 lumens	42.1	3-Lamp 32w T8 (BF < 0.88)	84.5	\$76
	LED 2x4 Recessed Light Fixture, 6001-7500 lumens	51.5	4-Lamp 32w T8 (BF < 0.88)	112.6	\$104
	LED 1x4 Recessed Light Fixture, 1500-3000 lumens	19.2	1-Lamp 32w T8 (BF < 0.91)	29.1	\$22
	LED 1x4 Recessed Light Fixture, 3001-4500 lumens	30.8	2-Lamp 32w T8 (BF < 0.89)	57.0	\$75
	LED 1x4 Recessed Light Fixture, 4501-6000 lumens	40.2	3-Lamp 32w T8 (BF < 0.88)	84.5	\$83
LED Linear Ambient Fixtures	LED Surface & Suspended Linear Fixture, <= 3000 lumens	17.6	1-Lamp 32w T8 (BF < 0.91)	29.1	\$10
	LED Surface & Suspended Linear Fixture, 3001-4500 lumens	28.0	2-Lamp 32w T8 (BF < 0.89)	57.0	\$52
	LED Surface & Suspended Linear Fixture, 4501-6000 lumens	39.2	3-Lamp 32w T8 (BF < 0.88)	84.5	\$78
	LED Surface & Suspended Linear Fixture, 6001-7500 lumens	49.9	T5HO 2L-F54T5HO - 4'	120.0	\$131
	LED Surface & Suspended Linear Fixture, > 7500 lumens	90.6	T5HO 3L-F54T5HO - 4'	180.0	\$173

LED Category	EE Measure Description	Watts _{EE}	Baseline Description	Watts _{BASE}	Incremental Cost
LED High & Low Bay Fixtures	LED Low-Bay Fixtures, <= 10,000 lumens	51.8	3-Lamp T8HO Low-Bay	157.0	\$42.88
	LED High-Bay Fixtures, 10,001-15,000 lumens	89.2	4-Lamp T8HO High-Bay	196.0	\$31.94
	LED High-Bay Fixtures, 15,001-20,000 lumens	118.5	6-Lamp T8HO High-Bay	294.0	\$61.17
	LED High-Bay Fixtures, 20,001-30,000 lumens	171.4	8-Lamp T8HO High-Bay	392.0	\$51.11
	LED High-Bay Fixtures, 30,001-40,000 lumens	230.5	750 Watts Metal Halide	850	\$113.60
	LED High-Bay Fixtures 40,001-50,000 lumens	306.2	1000 Watts Metal Halide	1080	\$166.55
	LED High-Bay Fixtures >50,000 lumens	443.7	1500 Watts Metal Halide	1610	\$283.67
LED Agricultural Interior Fixtures	LED Ag Interior Fixtures, <= 2,000 lumens	12.9	1-Lamp 32w T8 (BF <0.91)	29.1	\$18
	LED Ag Interior Fixtures, 2,001-4,000 lumens	29.7	2-Lamp 32w T8 (BF < 0.89)	57	\$48
	LED Ag Interior Fixtures, 4,001-6,000 lumens	45.1	25% 217 Watt EISA Inc, 75% 3L T8	121.0	\$57
	LED Ag Interior Fixtures, 6,001-8,000 lumens	59.7	25% 292 Watt EISA Inc, 75% 4L T8	159.0	\$88
	LED Ag Interior Fixtures, 8,001-12,000 lumens	84.9	200W Pulse Start Metal Halide	227.3	\$168
	LED Ag Interior Fixtures, 12,001-16,000 lumens	113.9	320W Pulse Start Metal Halide	363.6	\$151
	LED Ag Interior Fixtures, 16,001-20,000 lumens	143.7	350W Pulse Start Metal Halide	397.7	\$205
	LED Ag Interior Fixtures, > 20,000 lumens	193.8	(2) 320W Pulse Start Metal Halide	727.3	\$356
LED Exterior Fixtures	LED Exterior Fixtures, <= 5,000 lumens	27.5	100W Metal Halide	113.6	\$97
	LED Exterior Fixtures, 5,001-10,000 lumens	57.6	175W Pulse Start Metal Halide	198.9	\$123.81

LED Category	EE Measure Description	Watts _{EE}	Baseline Description	Watts _{BASE}	Incremental Cost
	LED Exterior Fixtures, 10,001-15,000 lumens	94.9	250W Pulse Start Metal Halide	284.1	\$134.35
	LED Exterior Fixtures, 15,001-30,000 lumens	161.3	400W Pulse Start Metal Halide	454.5	\$196.16
	LED Exterior Fixtures, 30,001-40,000 lumens	253.9	750 W Metal Halide	850	\$238.18
	LED Exterior Fixtures, 40,001-50,000 lumens	319.6	1000 W Metal Halide	1080	\$319.31
	LED Exterior Fixtures, > 50,000 lumens	585.9	1500 W Metal Halide	1610	\$1094.74
LED Mogul Base HID Replacement Lamps (if unknown, assume Type B)	LED Mogul Base HID Replacement Lamp, <= 5,000 lumens	31	100W Metal Halide	100 (Type A) 113.6 (Type B)	\$68
	LED Mogul Base HID Replacement Lamp, 5,001-10,000 lumens	64	175W Pulse Start Metal Halide	175 (Type A) 198.9 (Type B)	\$60
	LED Mogul Base HID Replacement Lamp, 10,001-15,000 lumens	101	250W Pulse Start Metal Halide	250 (Type A) 284.1 (Type B)	\$129
	LED Mogul Base HID Replacement Lamp, 15,001-30,000 lumens	141	400W Pulse Start Metal Halide	400 (Type A) 454.5 (Type B)	\$156
	LED Mogul Base HID Replacement Lamp, 30,001-40,000 lumens	236	750 W Metal Halide	750 (Type A) 850 (Type B)	\$446
	LED Mogul Base HID Replacement Lamp, > 40,000 lumens	295	1000 W Metal Halide	1000 (Type A) 1080 (Type B)	\$629

LED Fixture Component Costs & Lifetime¹²⁷²

¹²⁷² Note that some measures have blended baselines (T12:T8 18:82). All values are provided to enable calculation of appropriate O&M impacts. Total costs include lamp, labor and disposal cost assumptions where applicable, see IL LED Lighting Systems TRM Reference Tables_2018.xlsx for more information.

LED Category	EE Measure Description	EE Measure				Baseline			
		Lamp Life (hrs)	Total Lamp Replacement Cost	LED Driver Life (hrs)	Total LED Driver Replacement Cost	Lamp Life (hrs)	Total Lamp Replacement Cost	Ballast Life (hrs)	Total Lamp Replacement Cost
LED Downlight Fixtures	LED Recessed, Surface, Pendant Downlights	50,000	\$30.75	70,000	\$47.50	2,500	\$8.86	40,000	\$14.00
LED Interior Directional	LED Track Lighting	50,000	\$39.00	70,000	\$47.50	2,500	\$12.71	40,000	\$11.00
	LED Wall-Wash Fixtures	50,000	\$39.00	70,000	\$47.50	2,500	\$9.17	40,000	\$27.00
LED Display Case	LED Display Case Light Fixture	50,000	\$9.75/ft	70,000	\$11.88/ft	2,500	\$6.70	40,000	\$5.00
	LED Undercabinet Shelf-Mounted Task Light Fixtures	50,000	\$9.75/ft	70,000	\$11.88/ft	2,500	\$6.70	40,000	\$5.00
	LED Refrigerated Case Light, Horizontal or Vertical	50,000	\$8.63/ft	70,000	\$9.50/ft	15,000	\$1.13	40,000	\$8.00
	LED Freezer Case Light, Horizontal or Vertical	50,000	\$7.88/ft	70,000	\$7.92/ft	12,000	\$0.94	40,000	\$6.00
LED Linear Replacement Lamps	T8 LED Replacement Lamp (TLED), < 1200 lumens	50,000	\$5.76	70,000	\$13.67	30,000	\$6.17	40,000	\$11.00
	T8 LED Replacement Lamp (TLED), 1200-2400 lumens	50,000	\$8.57	70,000	\$13.67	24,000	\$6.17	40,000	\$11.00
	T8 LED Replacement Lamp (TLED), > 2400 lumens	50,000	\$8.57	70,000	\$13.67	18,000	\$6.17	40,000	\$11.00
LED Troffers	LED 2x2 Recessed Light Fixture, 2000-3500 lumens	50,000	\$78.07	70,000	\$40.00	24,000	\$26.33	40,000	\$35.00
	LED 2x2 Recessed Light Fixture, 3501-5000 lumens	50,000	\$89.23	70,000	\$40.00	24,000	\$39.50	40,000	\$35.00
	LED 2x4 Recessed Light Fixture, 3000-4500 lumens	50,000	\$96.10	70,000	\$40.00	24,000	\$12.33	40,000	\$35.00
	LED 2x4 Recessed Light Fixture, 4501-6000 lumens	50,000	\$114.37	70,000	\$40.00	24,000	\$18.50	40,000	\$35.00
	LED 2x4 Recessed Light Fixture, 6001-7500 lumens	50,000	\$137.43	70,000	\$40.00	24,000	\$24.67	40,000	\$35.00
	LED 1x4 Recessed Light Fixture, 1500-3000 lumens	50,000	\$65.43	70,000	\$40.00	24,000	\$6.17	40,000	\$35.00

LED Category	EE Measure Description	EE Measure				Baseline			
		Lamp Life (hrs)	Total Lamp Replacement Cost	LED Driver Life (hrs)	Total LED Driver Replacement Cost	Lamp Life (hrs)	Total Lamp Replacement Cost	Ballast Life (hrs)	Total Lamp Replacement Cost
	LED 1x4 Recessed Light Fixture, 3001-4500 lumens	50,000	\$100.44	70,000	\$40.00	24,000	\$12.33	40,000	\$35.00
	LED 1x4 Recessed Light Fixture, 4501-6000 lumens	50,000	\$108.28	70,000	\$40.00	24,000	\$18.50	40,000	\$35.00
LED Linear Ambient Fixtures	LED Surface & Suspended Linear Fixture, <= 3000 lumens	50,000	\$62.21	70,000	\$40.00	24,000	\$6.17	40,000	\$35.00
	LED Surface & Suspended Linear Fixture, 3001-4500 lumens	50,000	\$93.22	70,000	\$40.00	24,000	\$12.33	40,000	\$35.00
	LED Surface & Suspended Linear Fixture, 4501-6000 lumens	50,000	\$114.06	70,000	\$40.00	24,000	\$18.50	40,000	\$35.00
	LED Surface & Suspended Linear Fixture, 6001-7500 lumens	50,000	\$152.32	70,000	\$40.00	30,000	\$26.33	40,000	\$60.00
	LED Surface & Suspended Linear Fixture, > 7500 lumens	50,000	\$183.78	70,000	\$40.00	30,000	\$39.50	40,000	\$60.00
LED High & Low Bay Fixtures	LED Low-Bay Fixtures, <= 10,000 lumens	50,000	\$90.03	70,000	\$62.50	18,000	\$64.50	40,000	\$92.00
	LED High-Bay Fixtures, 10,001-15,000 lumens	50,000	\$122.59	70,000	\$62.50	18,000	\$86.00	40,000	\$92.00
	LED High-Bay Fixtures, 15,001-20,000 lumens	50,000	\$157.22	70,000	\$62.50	18,000	\$129.00	40,000	\$114.00
	LED High-Bay Fixtures, 20,001 – 30,000 lumens	50,000	\$228.52	70,000	\$62.50	18,000	\$172.00	40,000	\$144.00
	LED High-Bay Fixtures, 30,001-40,000 lumens	50,000	\$294.00	70,000	\$62.50	15,000	\$82.00	40,000	\$144.00
	LED High-Bay Fixtures, 40,001-50,000 lumens	50,000	\$324.00	70,000	\$62.50	15,000	\$88.00	40,000	\$144.00

LED Category	EE Measure Description	EE Measure				Baseline			
		Lamp Life (hrs)	Total Lamp Replacement Cost	LED Driver Life (hrs)	Total LED Driver Replacement Cost	Lamp Life (hrs)	Total Lamp Replacement Cost	Ballast Life (hrs)	Total Lamp Replacement Cost
	LED High-Bay Fixtures, > 50,000 lumens	50,000	\$382.00	70,000	\$62.50	15,000	\$96.00	40,000	\$200.00
LED Agricultural Interior Fixtures	LED Ag Interior Fixtures, <= 2,000 lumens	50,000	\$41.20	70,000	\$40.00	1,000	\$1.23	40,000	\$26.00
	LED Ag Interior Fixtures, 2,001-4,000 lumens	50,000	\$65.97	70,000	\$40.00	1,000	\$1.43	40,000	\$26.00
	LED Ag Interior Fixtures, 4,001-6,000 lumens	50,000	\$80.08	70,000	\$40.00	1,000	\$1.62	40,000	\$26.00
	LED Ag Interior Fixtures, 6,001-8,000 lumens	50,000	\$105.54	70,000	\$40.00	1,000	\$1.81	40,000	\$26.00
	LED Ag Interior Fixtures, 8,001-12,000 lumens	50,000	\$179.81	70,000	\$62.50	15,000	\$63.00	40,000	\$110.00
	LED Ag Interior Fixtures, 12,001-16,000 lumens	50,000	\$190.86	70,000	\$62.50	15,000	\$68.00	40,000	\$120.00
	LED Ag Interior Fixtures, 16,001-20,000 lumens	50,000	\$237.71	70,000	\$62.50	15,000	\$73.00	40,000	\$130.00
	LED Ag Interior Fixtures, > 20,000 lumens	50,000	\$331.73	70,000	\$62.50	15,000	\$136.00	40,000	\$200.00
LED Exterior Fixtures	LED Exterior Fixtures, <= 5,000 lumens	50,000	\$73.80	70,000	\$62.50	15,000	\$58.00	40,000	\$100.00
	LED Exterior Fixtures, 5,001-10,000 lumens	50,000	\$124.89	70,000	\$62.50	15,000	\$63.00	40,000	\$110.00
	LED Exterior Fixtures, 10,001-15,000 lumens	50,000	\$214.95	70,000	\$62.50	15,000	\$68.00	40,000	\$120.00
	LED Exterior Fixtures, 15,000- 30,000 lumens	50,000	\$321.06	70,000	\$62.50	15,000	\$73.00	40,000	\$130.00
	LED Exterior Fixtures, 30,001-40,000 lumens	50,000	\$546.00	70,000	\$62.50	15,000	\$82.00	40,000	\$140.00
	LED Exterior Fixtures, 40,001-50,000 lumens	50,000	\$722.00	70,000	\$62.50	15,000	\$88.00	40,000	\$140.00
	LED Exterior Fixtures, > 50,000 lumens	50,000	\$870.00	70,000	\$62.50	15,000	\$96.00	40,000	\$200.00

LED Category	EE Measure Description	EE Measure				Baseline			
		Lamp Life (hrs)	Total Lamp Replacement Cost	LED Driver Life (hrs)	Total LED Driver Replacement Cost	Lamp Life (hrs)	Total Lamp Replacement Cost	Ballast Life (hrs)	Total Replacement Cost
LED Mogul Base HID Replacement Lamps	LED Mogul Base HID Replacement Lamp, <= 5,000 lumens	50,000	\$108.00	70,000	\$62.50	15,000	\$40.00	40,000	\$92.50
	LED Mogul Base HID Replacement Lamp, 5,001-10,000 lumens	50,000	\$99.00	70,000	\$62.50	15,000	\$39.00	40,000	\$92.50
	LED Mogul Base HID Replacement Lamp, 10,001-15,000 lumens	50,000	\$179.00	70,000	\$62.50	15,000	\$50.00	40,000	\$111.50
	LED Mogul Base HID Replacement Lamp, 15,001-30,000 lumens	50,000	\$210.00	70,000	\$62.50	15,000	\$54.00	40,000	\$141.50
	LED Mogul Base HID Replacement Lamp, 30,001-40,000 lumens	50,000	\$514.00	70,000	\$62.50	15,000	\$68.00	40,000	\$141.50
	LED Mogul Base HID Replacement Lamp, > 40,000 lumens	50,000	\$707.00	70,000	\$62.50	15,000	\$78.00	40,000	\$141.50

MEASURE CODE: CI-LTG-LEDB-V18-250101

REVIEW DEADLINE: 1/1/2027

4.5.5 Commercial LED Exit Signs

DESCRIPTION

This measure characterizes the savings associated with installing a Light Emitting Diode (LED) exit sign in place of a fluorescent or incandescent exit sign in a Commercial building. Light Emitting Diode exit signs have a string of very small, typically red or green, glowing LEDs arranged in a circle or oval. The LEDs may also be arranged in a line on the side, top or bottom of the exit sign. LED exit signs provide the best balance of safety, low maintenance, and very low energy usage compared to other exit sign technologies.

This measure was developed to be applicable to the following program types: RF.

If applied to other program types, the measure savings should be verified.

DEFINITION OF EFFICIENT EQUIPMENT

The efficient equipment is assumed to be an exit sign illuminated by LEDs.

DEFINITION OF BASELINE EQUIPMENT

The baseline equipment is assumed to be an existing fluorescent or incandescent model.

DEEMED LIFETIME OF EFFICIENT EQUIPMENT

The measure life is assumed to be 5 years.¹²⁷³

DEEMED MEASURE COST

The actual material and labor costs should be used if available. If actual costs are unavailable, assume a total installed cost of at \$32.50.¹²⁷⁴

LOADSHAPE

Loadshape C53 - Flat

COINCIDENCE FACTOR

The summer peak coincidence factor for this measure is assumed to be 100%.¹²⁷⁵

Algorithm

CALCULATION OF SAVINGS

ELECTRIC ENERGY SAVINGS

$$\Delta kWh = ((WattsBase - WattsEE) / 1,000) * HOURS * WHF_e$$

Where:

WattsBase = Actual wattage if known, if unknown assume the following:

Baseline Type	Watts _{Base}
Incandescent	35W ¹²⁷⁶
CFL (dual sided)	14W ¹²⁷⁷
CFL (single sided)	7W
Unknown	7W

¹²⁷³ Estimate of remaining life of existing unit being replaced.

¹²⁷⁴ Price includes new exit sign/fixture and installation. LED exit sign cost/unit is \$22.50 based on the NYSERDA Deemed Savings Database and review of LED exit signs available as of April 2023, and assuming IL labor cost of 15 minutes @ \$40/hr.

¹²⁷⁵ Assuming continuous operation of an LED exit sign, the Summer Peak Coincidence Factor is assumed to equal 1.0.

¹²⁷⁶ Based on review of available product.

¹²⁷⁷ Average CFL single sided (5W, 7W, 9W) from Appendix B 2013-14 Table of Standard Fixture Wattages.

WattsEE	= Actual wattage if known, if unknown assume 2W for single sided or unknown type and 4W for dual sided ¹²⁷⁸
HOURS	= Annual operating hours = 8,766
WHF _e	= Waste heat factor for energy to account for cooling energy savings from efficient lighting are provided for each building type in the Reference Table in Section 4.5. If unknown, use the Miscellaneous value.

For example, replacing incandescent fixture in a mid rise office:

$$\begin{aligned} \Delta kWh &= ((35 - 2)/1,000) * 8766 * 1.17 \\ &= 338 \text{ kWh} \end{aligned}$$

Replacing single sided fluorescent fixture in a hospital with CAV economizer:

$$\begin{aligned} \Delta kWh &= ((7 - 2)/1,000) * 8766 * 1.30 \\ &= 57.0 \text{ kWh} \end{aligned}$$

HEATING PENALTY

If electrically heated building:

$$\Delta kWh_{\text{heatpenalty}}^{1279} = (((\text{WattsBase} - \text{WattsEE}) / 1,000) * \text{Hours} * -\text{IFkWh})$$

Where:

IFkWh	= Lighting-HVAC Interaction Factor for electric heating impacts; this factor represents the increased electric space heating requirements due to the reduction of waste heat rejected by the efficient lighting. Values are provided in the Reference Table in Section 4.5. If unknown, use the Miscellaneous value.
-------	--

For example, replacing incandescent fixture in a heat pump heated mid rise office:

$$\begin{aligned} \Delta kWh_{\text{heatpenalty}} &= ((35 - 2)/1,000) * 8,766 * -0.104 \\ &= -30.1 \text{ kWh} \end{aligned}$$

Replacing single sided fluorescent fixture in a heat pump heated hospital with CAV economizer:

$$\begin{aligned} \Delta kWh_{\text{heatpenalty}} &= ((7 - 2)/1,000) * 8,766 * -0.099 \\ &= -4.3 \text{ kWh} \end{aligned}$$

SUMMER COINCIDENT PEAK DEMAND SAVINGS

$$\Delta kW = ((\text{WattsBase} - \text{WattsEE}) / 1,000) * \text{WHF}_d * \text{CF}$$

Where:

WHF _d	= Waste heat factor for demand to account for cooling savings from efficient lighting in cooled buildings is provided in the Reference Table in Section 4.5. If unknown, use the Miscellaneous value.
CF	= Summer Peak Coincidence Factor for measure = 1.0

¹²⁷⁸ Average LED single sided (2W) from Appendix B 2013-14 Table of Standard Fixture Wattages.

¹²⁷⁹Negative value because this is an increase in heating consumption due to the efficient lighting.

For example, replacing incandescent fixture in a mid rise office:

$$\begin{aligned} \Delta kW &= ((35 - 2)/1,000) * 1.36 * 1.0 \\ &= 0.045 \text{ kW} \end{aligned}$$

Replacing single sided fluorescent fixture in a hospital with CAV economizer:

$$\begin{aligned} \Delta kW &= ((7 - 2)/1,000) * 1.27 * 1.0 \\ &= 0.0064 \text{ kW} \end{aligned}$$

FOSSIL FUEL SAVINGS

Heating Penalty if natural gas heated building (or if heating fuel is unknown):

$$\Delta \text{therms} = ((\text{WattsBase} - \text{WattsEE}) / 1000) * \text{Hours} * \text{IFTherms}$$

Where:

IFTherms = Lighting-HVAC Integration Factor for gas heating impacts; this factor represents the increased gas space heating requirements due to the reduction of waste heat rejected by the efficient lighting. Values are provided in the Reference Table in Section 4.5. If unknown, use the Miscellaneous value.

For example, replacing incandescent fixture in a mid rise office:

$$\begin{aligned} \Delta \text{Therms} &= ((35 - 2) / 1,000) * 8,766 * -0.016 \\ &= -4.63 \text{ Therms} \end{aligned}$$

Replacing single sided fluorescent fixture in a hospital with CAV economizer:

$$\begin{aligned} \Delta \text{Therms} &= ((7 - 2) / 1,000) * 8,766 * -0.009 \\ &= -0.39 \text{ Therms} \end{aligned}$$

WATER IMPACT DESCRIPTIONS AND CALCULATION

N/A

DEEMED O&M COST ADJUSTMENT CALCULATION

The annual O&M Cost Adjustment savings should be calculated using the following component costs and lifetimes.

Component	Baseline Measures	
	Cost	Life (yrs)
Lamp	\$12.45 ¹²⁸⁰	1.37 years ¹²⁸¹

MEASURE CODE: CI-LTG-LEDE-V05-250101

REVIEW DEADLINE: 1/1/2028

¹²⁸⁰ Consistent with assumption for a Standard CFL bulb (\$2.45) with an estimated labor cost of \$10 (assuming \$40/hour and a task time of 15 minutes).

¹²⁸¹ Assumes a lamp life of 12,000 hours and 8766 run hours 12000/8766 = 1.37 years.

4.5.6 LED Traffic and Pedestrian Signals

DESCRIPTION

Traffic and pedestrian signals are retrofitted to be illuminated with light emitting diodes (LED) instead of incandescent lamps. Incentive applies for the replacement or retrofit of existing incandescent traffic signals with new LED traffic and pedestrian signal lamps. Each lamp can have no more than a maximum LED module wattage of 25. Incentives are not available for spare lights. Lights must be hardwired and single lamp replacements are not eligible, with the exception of pedestrian hand signals. Eligible lamps must meet the Energy Star Traffic Signal Specification and the Institute for Transportation Engineers specification for traffic signals.

This measure was developed to be applicable to the following program types: RF.

If applied to other program types, the measure savings should be verified.

DEFINITION OF EFFICIENT EQUIPMENT

Refer to the Table titled ‘Traffic Signals Technology Equivalencies’ for efficient technology wattage and savings assumptions.

DEFINITION OF BASELINE EQUIPMENT

Refer to the Table titled ‘Traffic Signals Technology Equivalencies’ for baseline efficiencies and savings assumptions.

DEEMED LIFETIME OF EFFICIENT EQUIPMENT

The assumed lifetime of an LED traffic signal is 10 years. The life in years is calculated by dividing 100,000 hrs (manufacturer’s estimate) by the annual operating hours for the particular signal type and is capped at 10 years.¹²⁸².

DEEMED MEASURE COST

The actual measure installation cost should be used (including material and labor).

LOADSHAPE

- Loadshape C24 - Traffic Signal - Red Balls, always changing or flashing
- Loadshape C25 - Traffic Signal - Red Balls, changing day, off night
- Loadshape C26 - Traffic Signal - Green Balls, always changing
- Loadshape C27 - Traffic Signal - Green Balls, changing day, off night
- Loadshape C28 - Traffic Signal - Red Arrows
- Loadshape C29 - Traffic Signal - Green Arrows
- Loadshape C30 - Traffic Signal - Flashing Yellows
- Loadshape C31 - Traffic Signal - “Hand” Don’t Walk Signal
- Loadshape C32 - Traffic Signal - “Man” Walk Signal
- Loadshape C33 - Traffic Signal - Bi-Modal Walk/Don’t Walk

COINCIDENCE FACTOR¹²⁸³

The summer peak coincidence factor (CF) for this measure is dependent on lamp type as below:

Lamp Type	CF
Red Round, always changing or flashing	0.55
Red Arrows	0.90
Green Arrows	0.10
Yellow Arrows	0.03

¹²⁸² ACEEE, (1998) A Market Transformation Opportunity Assessment for LED Traffic Signals

¹²⁸³ Ibid.

Lamp Type	CF
Green Round, always changing or flashing	0.43
Flashing Yellow	0.50
Yellow Round, always changing	0.02
“Hand” Don’t Walk Signal	0.75
“Man” Walk Signal	0.21

Algorithm

CALCULATION OF SAVINGS

ELECTRIC ENERGY SAVINGS

$$\Delta kWh = (W_{base} - W_{eff}) \times \text{HOURS} / 1000$$

Where:

- Wbase = The connected load of the baseline equipment
= see Table ‘Traffic Signals Technology Equivalencies’
- Weff = The connected load of the baseline equipment
= see Table ‘Traffic Signals Technology Equivalencies’
- HOURS = annual operating hours of the lamp
= see Table ‘Traffic Signals Technology Equivalencies’
- 1000 = conversion factor (W/kW)

For example, an 8 inch red, round signal:

$$\begin{aligned} \Delta kWh &= ((69 - 7) \times 4818) / 1000 \\ &= 299 \text{ kWh} \end{aligned}$$

SUMMER COINCIDENT PEAK DEMAND SAVINGS

$$\Delta kW = (W_{base} - W_{eff}) \times CF / 1000$$

Where:

- Wbase = The connected load of the baseline equipment
= see Table ‘Traffic Signals Technology Equivalencies’
- Weff = The connected load of the efficient equipment
= see Table ‘Traffic Signals Technology Equivalencies’
- CF = Summer Peak Coincidence Factor for measure

For example, an 8 inch red, round signal:

$$\begin{aligned} \Delta kW &= ((69 - 7) \times 0.55) / 1000 \\ &= 0.0341 \text{ kW} \end{aligned}$$

FOSSIL FUEL SAVINGS

N/A

WATER IMPACT DESCRIPTIONS AND CALCULATION

N/A

REFERENCE TABLES

Traffic Signals Technology Equivalencies¹²⁸⁴

Traffic Fixture Type	Fixture Size and Color	Efficient Lamps	Baseline Lamps	HOURS	Efficient Fixture Wattage	Baseline Fixture Wattage	Energy Savings (in kWh)
Round Signals	8" Red	LED	Incandescent	4818	7	69	299
Round Signals	12" Red	LED	Incandescent	4818	6	150	694
Flashing Signal ¹²⁸⁵	8" Red	LED	Incandescent	4380	7	69	272
Flashing Signal	12" Red	LED	Incandescent	4380	6	150	631
Flashing Signal	8" Yellow	LED	Incandescent	4380	10	69	258
Flashing Signal	12" Yellow	LED	Incandescent	4380	13	150	600
Round Signals	8" Yellow	LED	Incandescent	175	10	69	10
Round Signals	12" Yellow	LED	Incandescent	175	13	150	24
Round Signals	8" Green	LED	Incandescent	3767	9	69	226
Round Signals	12" Green	LED	Incandescent	3767	12	150	520
Turn Arrows	8" Yellow	LED	Incandescent	701	7	116	76
Turn Arrows	12" Yellow	LED	Incandescent	701	9	116	75
Turn Arrows	8" Green	LED	Incandescent	701	7	116	76
Turn Arrows	12" Green	LED	Incandescent	701	7	116	76
Pedestrian Sign	12" Hand/Man	LED	Incandescent	8766	8	116	947

Reference specifications for above traffic signal wattages are from the following manufacturers:

1. 8" Incandescent traffic signal bulb: General Electric Traffic Signal Model 17325-69A21/TS
2. 12" Incandescent traffic signal bulb: General Electric Signal Model 35327-150PAR46/TS
3. Incandescent Arrows & Hand/Man Pedestrian Signs: General Electric Traffic Signal Model 19010-116A21/TS
4. 8" and 12" LED traffic signals: Leotek Models TSL-ES08 and TSL-ES12
5. 8" LED Yellow Arrow: General Electric Model DR4-YTA2-01A
6. 8" LED Green Arrow: General Electric Model DR4-GCA2-01A
7. 12" LED Yellow Arrow: Dialight Model 431-3334-001X
8. 12" LED Green Arrow: Dialight Model 432-2324-001X
9. LED Hand/Man Pedestrian Sign: Dialight 430-6450-001X

MEASURE CODE: CI-LTG-LEDT-V04-240101

REVIEW DEADLINE: 1/1/2027

¹²⁸⁴ Technical Reference Manual for Pennsylvania Act 129 Energy Efficiency and Conservation Program and Act 213 Alternative Energy Portfolio Standards. Pennsylvania Public Utility Commission. May 2009.

¹²⁸⁵ Technical Reference Manual for Ohio, August 6, 2010.

4.5.7 Lighting Power Density

DESCRIPTION

This measure relates to installation of efficient lighting systems in new construction or substantial renovation of commercial buildings excluding low rise (three stories or less) residential buildings. Substantial renovation is when two or more building systems are renovated, such as shell and heating, heating and lighting, etc. State Energy Code specifies a lighting power density level by building type for both the interior and the exterior. Either the Building Area Method or Space by Space method as defined in 2015, 2018, or 2021, depending on the IECC in effect on the date of the building permit (if unknown assume IECC 2021), can be used for calculating the Interior Lighting Power Density.¹²⁸⁶ The measure consists of a design that is more efficient (has a lower lighting power density in watts/square foot) than code requires. The IECC applies to both new construction and renovation.

This measure was developed to be applicable to the following program types: NC.

If applied to other program types, the measure savings should be verified.

DEFINITION OF EFFICIENT EQUIPMENT

In order for this characterization to apply, the lighting system must be more efficient than the baseline Energy Code lighting power density in watts/square foot for either the interior space or exterior space.

DEFINITION OF BASELINE EQUIPMENT

The baseline is assumed to be a lighting power density that meets the IECC in effect on the date of the building permit (if unknown assume IECC 2021).

Note, IECC 2021 became effective statewide on 1/1/2024. IECC 2018 is the requisite code for any projects with permitting dates spanning July 1, 2019 to 12/31/2023. Prior to July 1, 2019, IECC 2015 is the applicable code. As code requirements and adoption can differ from municipality to municipality, the user should verify which version of code is applicable given these constraints.

DEEMED CALCULATION FOR THIS MEASURE

Annual kWh Savings

$$\Delta \text{kWh} = (\text{WSF}_{\text{base}} - \text{WSF}_{\text{effic}}) / 1000 * \text{SF} * \text{Hours} * \text{WHF}_e$$

Summer Coincident Peak kW Savings

$$\Delta \text{kW} = (\text{WSF}_{\text{base}} - \text{WSF}_{\text{effic}}) / 1000 * \text{SF} * \text{CF} * \text{WHF}_d$$

DEEMED LIFETIME OF EFFICIENT EQUIPMENT

The expected measure life is assumed to be 15 years.¹²⁸⁷

DEEMED MEASURE COST

The actual incremental cost over a baseline system will be collected from the customer if possible or developed on a fixture by fixture basis.

LOADSHAPE

Loadshape C06 - Commercial Indoor Lighting

Loadshape C07 - Grocery/Conv. Store Indoor Lighting

Loadshape C08 - Hospital Indoor Lighting

¹²⁸⁶ Refer to the referenced code documents for specifics on calculating lighting power density using either the whole building method or the Space by Space method.

¹²⁸⁷ Measure Life Report, Residential and Commercial/Industrial/Industrial Lighting and HVAC Measures, GDS Associates, June 2007.

- Loadshape C09 - Office Indoor Lighting
- Loadshape C10 - Restaurant Indoor Lighting
- Loadshape C11 - Retail Indoor Lighting
- Loadshape C12 - Warehouse Indoor Lighting
- Loadshape C13 - K-12 School Indoor Lighting
- Loadshape C14 - Indust. 1-shift (8/5) (e.g., comp. air, lights)
- Loadshape C15 - Indust. 2-shift (16/5) (e.g., comp. air, lights)
- Loadshape C16 - Indust. 3-shift (24/5) (e.g., comp. air, lights)
- Loadshape C17 - Indust. 4-shift (24/7) (e.g., comp. air, lights)
- Loadshape C18 - Industrial Indoor Lighting
- Loadshape C19 - Industrial Outdoor Lighting
- Loadshape C20 - Commercial Outdoor Lighting

COINCIDENCE FACTOR

The summer peak coincidence factor for this measure is dependent on the building type.

Algorithm

CALCULATION OF SAVINGS

ENERGY SAVINGS

$$\Delta kWh = (WSF_{base} - WSF_{effic}) / 1000 * SF * Hours * WHF_e$$

Where:

- WSF_{base} = Baseline lighting watts per square foot or linear foot as determined by building or space type. Whole building analysis values are presented in the Reference Tables below.¹²⁸⁸
- WSF_{effic} = The actual installed lighting watts per square foot or linear foot.
- SF = Provided by customer based on square footage of the building area applicable to the lighting design for new building.
- Hours = Annual site-specific hours of operation of the lighting equipment collected from the customer. If not available, use building area type as provided in the Reference Table in Section 4.5, Fixture annual operating hours.
- WHF_e = Waste Heat Factor for Energy to account for cooling savings from efficient lighting is as provided in the Reference Table in Section 4.5 by building type. If building is not cooled WHF_e is 1.

HEATING PENALTY

If electrically heated building:

$$\Delta kWh_{heatpenalty}^{1289} = (WSF_{base} - WSF_{effic}) / 1000 * SF * Hours * -IFkWh$$

Where:

- IFkWh = Lighting-HVAC Interaction Factor for electric heating impacts; this factor represents the increased electric space heating requirements due to the reduction of waste heat rejected

¹²⁸⁸See Reference Code documentation for additional information.

¹²⁸⁹Negative value because this is an increase in heating consumption due to the efficient lighting.

by the efficient lighting. Values are provided in the Reference Table in Section 4.5. If unknown, use the Miscellaneous value.

SUMMER COINCIDENT PEAK DEMAND SAVINGS

$$\Delta kW = (WSF_{base} - WSF_{effic}) / 1000 * SF * CF * WHF_d$$

Where:

WHF_d = Waste Heat Factor for Demand to account for cooling savings from efficient lighting in cooled buildings is as provided in the Reference Table in Section 4.5 by building type. If building is not cooled WHF_d is 1.

CF = Summer Peak Coincidence Factor for measure is as provided in the Reference Table in Section 4.5 by building type. If the building type is unknown, use the Miscellaneous value of 0.66.

Other factors as defined above

FOSSIL FUEL SAVINGS

$$\Delta \text{Therms} = (WSF_{base} - WSF_{effic}) / 1000 * SF * \text{Hours} * - \text{IFTherms}$$

Where:

IFTherms = Lighting-HVAC Integration Factor for gas heating impacts; this factor represents the increased gas space heating requirements due to the reduction of waste heat rejected by the efficient lighting. This value is provided in the Reference Table in Section 4.5 by building type.

WATER IMPACT DESCRIPTIONS AND CALCULATION

N/A

DEEMED O&M COST ADJUSTMENT CALCULATION

N/A

REFERENCE TABLES

Lighting Power Density Values from 2015, 2018, and 2021 for Interior Commercial New Construction and Substantial Renovation Building Area Method:

Building Area Type ¹²⁹⁰	IECC 2015 Lighting Power Density (w/ft ²)	IECC 2018 Lighting Power Density (w/ft ²)	IECC 2021 Lighting Power Density (w/ft ²)
Automotive Facility	0.80	0.71	0.75
Convention Center	1.01	0.76	0.64
Court House	1.01	0.9	0.79
Dining: Bar Lounge/Leisure	1.01	0.9	0.80
Dining: Cafeteria/Fast Food	0.9	0.79	0.76
Dining: Family	0.95	0.78	0.71
Dormitory	0.57	0.61	0.53
Exercise Center	0.84	0.65	0.72
Fire station	0.67	0.53	0.56
Gymnasium	0.94	0.68	0.76
Healthcare – clinic	0.90	0.82	0.81

¹²⁹⁰ In cases where both a general building area type and a more specific building area type are listed, the more specific building area type shall apply.

Building Area Type ¹²⁹⁰	IECC 2015 Lighting Power Density (w/ft ²)	IECC 2018 Lighting Power Density (w/ft ²)	IECC 2021 Lighting Power Density (w/ft ²)
Hospital	1.05	1.05	0.96
Hotel	0.87	0.75	0.56
Library	1.19	0.78	0.83
Manufacturing Facility	1.17	0.90	0.82
Motel	0.87	0.75	0.56
Motion Picture Theater	0.76	0.83	0.44
Multifamily	0.51	0.68	0.45
Museum	1.02	1.06	0.55
Office	0.82	0.79	0.64
Parking Garage	0.21	0.15	0.18
Penitentiary	0.81	0.75	0.69
Performing Arts Theater	1.39	1.18	0.84
Police Station	0.87	0.80	0.66
Post Office	0.87	0.67	0.65
Religious Building	1.0	0.94	0.67
Retail ¹²⁹¹	1.26	1.06	0.84
School/University	0.87	0.81	0.72
Sports Arena	0.91	0.87	0.76
Town Hall	0.89	0.80	0.69
Transportation	0.70	0.61	0.50
Warehouse	0.66	0.48	0.45
Workshop	1.19	0.90	0.91

¹²⁹¹ Where lighting equipment is specified to be installed to highlight specific merchandise in addition to lighting equipment specified for general lighting and is switched or dimmed on circuits different from the circuits for general lighting, the small of the actual wattage of the lighting equipment installed specifically for merchandise, or additional lighting power as determined below shall be added to the interior lighting power determined in accordance with this line item.

Lighting Power Density Values from IECC 2015 for Interior Commercial New Construction and Substantial Renovation Space by Space Method:

**TABLE C405.4.2(2)
INTERIOR LIGHTING POWER ALLOWANCES:
SPACE-BY-SPACE METHOD**

COMMON SPACE TYPES ^a	LPD (watts/sq.ft)
Atrium	
Less than 40 feet in height	0.03 per foot in total height
Greater than 40 feet in height	0.40 + 0.02 per foot in total height
Audience seating area	
In an auditorium	0.63
In a convention center	0.82
In a gymnasium	0.65
In a motion picture theater	1.14
In a penitentiary	0.28
In a performing arts theater	2.43
In a religious building	1.53
In a sports arena	0.43
Otherwise	0.43
Banking activity area	1.01
Breakroom (See Lounge/Breakroom)	
Classroom/lecture hall/training room	
In a penitentiary	1.34
Otherwise	1.24
Conference/meeting/multipurpose room	1.23
Copy/print room	0.72
Corridor	
In a facility for the visually impaired (and not used primarily by the staff) ^b	0.92
In a hospital	0.79
In a manufacturing facility	0.41
Otherwise	0.66
Courtroom	1.72
Computer room	1.71
Dining area	
In a penitentiary	0.96
In a facility for the visually impaired (and not used primarily by the staff) ^b	1.9
In bar/lounge or leisure dining	1.07
In cafeteria or fast food dining	0.65
In family dining	0.89
Otherwise	0.65
Electrical/mechanical room	0.95
Emergency vehicle garage	0.56

(continued)

**TABLE C405.4.2(2)—continued
INTERIOR LIGHTING POWER ALLOWANCES:
SPACE-BY-SPACE METHOD**

COMMON SPACE TYPES ^a	LPD (watts/sq.ft)
Food preparation area	1.21
Guest room	0.47
Laboratory	
In or as a classroom	1.43
Otherwise	1.81
Laundry/washing area	0.6
Loading dock, interior	0.47
Lobby	
In a facility for the visually impaired (and not used primarily by the staff) ^b	1.8
For an elevator	0.64
In a hotel	1.06
In a motion picture theater	0.59
In a performing arts theater	2.0
Otherwise	0.9
Locker room	0.75
Lounge/breakroom	
In a healthcare facility	0.92
Otherwise	0.73
Office	
Enclosed	1.11
Open plan	0.98
Parking area, interior	0.19
Pharmacy area	1.68
Restroom	
In a facility for the visually impaired (and not used primarily by the staff) ^b	1.21
Otherwise	0.98
Sales area	1.59
Seating area, general	0.54
Stairway (See space containing stairway)	
Stairwell	0.69
Storage room	0.63
Vehicular maintenance area	0.67
Workshop	1.59
BUILDING TYPE SPECIFIC SPACE TYPES ^a	LPD (watts/sq.ft)
Facility for the visually impaired^b	
In a chapel (and not used primarily by the staff)	2.21
In a recreation room (and not used primarily by the staff)	2.41
Automotive (See Vehicular Maintenance Area above)	
Convention Center—exhibit space	1.45
Dormitory—living quarters	0.38
Fire Station—sleeping quarters	0.22
Gymnasium/fitness center	
In an exercise area	0.72
In a playing area	1.2

(continued)

**TABLE C405.4.2(2)—continued
INTERIOR LIGHTING POWER ALLOWANCES:
SPACE-BY-SPACE METHOD**

BUILDING TYPE SPECIFIC SPACE TYPES ^a	LPD (watts/sq.ft)
healthcare facility	
In an exam/treatment room	1.66
In an imaging room	1.51
In a medical supply room	0.74
In a nursery	0.88
In a nurse's station	0.71
In an operating room	2.48
In a patient room	0.62
In a physical therapy room	0.91
In a recovery room	1.15
Library	
In a reading area	1.06
In the stacks	1.71
Manufacturing facility	
In a detailed manufacturing area	1.29
In an equipment room	0.74
In an extra high bay area (greater than 50' floor-to-ceiling height)	1.05
In a high bay area (25-50' floor-to-ceiling height)	1.23
In a low bay area (less than 25' floor-to-ceiling height)	1.19
Museum	
In a general exhibition area	1.05
In a restoration room	1.02
Performing arts theater—dressing room	0.61
Post Office—Sorting Area	0.94
Religious buildings	
In a fellowship hall	0.64
In a worship/pulpit/choir area	1.53
Retail facilities	
In a dressing/fitting room	0.71
In a mall concourse	1.1
Sports arena—playing area	
For a Class I facility	3.68
For a Class II facility	2.4
For a Class III facility	1.8
For a Class IV facility	1.2
Transportation facility	
In a baggage/carousel area	0.53
In an airport concourse	0.36
At a terminal ticket counter	0.8
Warehouse—storage area	
For medium to bulky, palletized items	0.58
For smaller, hand-carried items	0.95

a. In cases where both a common space type and a building area specific space type are listed, the building area specific space type shall apply
 b. A 'Facility for the Visually Impaired' is a facility that is licensed or will be licensed by local or state authorities for senior long-term care, adult daycare, senior support or people with special visual needs.

Lighting Power Density Values from IECC 2018 for Interior Commercial New Construction and Substantial Renovation Space by Space Method:

TABLE C405.3.2(2)
INTERIOR LIGHTING POWER ALLOWANCES: SPACE-BY-SPACE METHOD

COMMON SPACE TYPES ^a	LPD (watts/sq.ft)
Atrium	
Less than 40 feet in height	0.03 per foot in total height
Greater than 40 feet in height	0.40 + 0.02 per foot in total height
Audience seating area	
In an auditorium	0.63
In a convention center	0.82
In a gymnasium	0.65
In a motion picture theater	1.14
In a penitentiary	0.28
In a performing arts theater	2.03
In a religious building	1.53
In a sports arena	0.43
Otherwise	0.43
Banking activity area	0.88
Breakroom (See Lounge/breakroom)	
Classroom/lecture hall/training room	
In a penitentiary	1.34
Otherwise	0.96
Computer room	1.33
Conference/meeting/multipurpose room	1.07
Copy/print room	0.56
Corridor	
In a facility for the visually impaired (and not used primarily by the staff) ^b	0.92
In a hospital	0.92
In a manufacturing facility	0.29
Otherwise	0.66
Courtroom	1.39
Dining area	
In bar/lounge or leisure dining	0.93
In cafeteria or fast food dining	0.63
In a facility for the visually impaired (and not used primarily by the staff) ^b	2.00
In family dining	0.71
In a penitentiary	0.96
Otherwise	0.63
Electrical/mechanical room	0.43
Emergency vehicle garage	0.41
Food preparation area	1.08
Guestroom ^{c, d}	0.77
Laboratory	
In or as a classroom	1.20
Otherwise	1.45

Laundry/washing area	0.43
Loading dock, interior	0.58
Lobby	
For an elevator	0.68
In a facility for the visually impaired (and not used primarily by the staff) ⁵	2.03
In a hotel	1.06
In a motion picture theater	0.45
In a performing arts theater	1.70
Otherwise	1.0
Locker room	0.48
Lounge/breakroom	
In a healthcare facility	0.78
Otherwise	0.62
Office	
Enclosed	0.93
Open plan	0.81
Parking area, interior	0.14
Pharmacy area	1.34
Restroom	
In a facility for the visually impaired (and not used primarily by the staff) ⁶	0.96
Otherwise	0.85
Sales area	1.22
Seating area, general	0.42
Stairway (see Space containing stairway)	
Stairwell	0.58
Storage room	0.46
Vehicular maintenance area	0.58
Workshop	1.14

BUILDING TYPE SPECIFIC SPACE TYPES ^a	LPD (watts/sq.ft)
Automotive (see Vehicular maintenance area)	
Convention Center—exhibit space	0.88
Dormitory—living quarters ^{c, d}	0.54
Facility for the visually impaired ^b	
In a chapel (and not used primarily by the staff)	1.08
In a recreation room (and not used primarily by the staff)	1.80
Fire Station—sleeping quarters ^c	0.20
Gymnasium/fitness center	
In an exercise area	0.50
In a playing area	0.82
Healthcare facility	
In an exam/treatment room	1.88
In an imaging room	1.08
In a medical supply room	0.54
In a nursery	1.00
In a nurse's station	0.81
In an operating room	2.17
In a patient room ^c	0.62
In a physical therapy room	0.84
In a recovery room	1.03
Library	
In a reading area	0.82
In the stacks	1.20
Manufacturing facility	
In a detailed manufacturing area	0.93
In an equipment room	0.65
In an extra-high-bay area (greater than 50' floor-to-ceiling height)	1.05
In a high-bay area (25-50' floor-to-ceiling height)	0.75
In a low-bay area (less than 25' floor-to-ceiling height)	0.96
Museum	
In a general exhibition area	1.05
In a restoration room	0.85
Performing arts theater—dressing room	0.38
Post office—sorting area	0.68
Religious buildings	
In a fellowship hall	0.55
In a worship/pulpit/choir area	1.53

Retail facilities	
In a dressing/fitting room	0.50
In a mall concourse	0.90
Sports arena—playing area	
For a Class I facility ^a	2.47
For a Class II facility ^f	1.98
For a Class III facility ^g	1.70
For a Class IV facility ^h	1.13
Transportation facility	
In a baggage/carousel area	0.45
In an airport concourse	0.31
At a terminal ticket counter	0.82
Warehouse—storage area	
For medium to bulky, palletized items	0.35
For smaller, hand-carried items	0.89

- a. In cases where both a common space type and a building area specific space type are listed, the building area specific space type shall apply.
- b. A 'Facility for the Visually Impaired' is a facility that is licensed or will be licensed by local or state authorities for senior long-term care, adult daycare, senior support or people with special visual needs.
- c. Where sleeping units are excluded from lighting power calculations by application of Section R405.1, neither the area of the sleeping units nor the wattage of lighting in the sleeping units is counted.
- d. Where dwelling units are excluded from lighting power calculations by application of Section R405.1, neither the area of the dwelling units nor the wattage of lighting in the dwelling units is counted.
- e. Class I facilities consist of professional facilities; and semiprofessional, collegiate, or club facilities with seating for 5,000 or more spectators.
- f. Class II facilities consist of collegiate and semiprofessional facilities with seating for fewer than 5,000 spectators; club facilities with seating for between 2,000 and 5,000 spectators; and amateur league and high-school facilities with seating for more than 2,000 spectators.
- g. Class III facilities consist of club, amateur league and high-school facilities with seating for 2,000 or fewer spectators.
- h. Class IV facilities consist of elementary school and recreational facilities; and amateur league and high-school facilities without provision for spectators.

Lighting Power Density Values from IECC 2021 for Interior Commercial New Construction and Substantial Renovation Space by Space Method:

**TABLE C405.3.2(2)
INTERIOR LIGHTING POWER ALLOWANCES:
SPACE-BY-SPACE METHOD**

COMMON SPACE TYPES*	LPD (watts/ft ²)
Atrium	
Less than 40 feet in height	0.48
Greater than 40 feet in height	0.60
Audience seating area	
In an auditorium	0.61
In a gymnasium	0.23
In a motion picture theater	0.27
In a penitentiary	0.67
In a performing arts theater	1.16
In a religious building	0.72
In a sports arena	0.33
Otherwise	0.33
Banking activity area	0.61
Breakroom (See Lounge/breakroom)	
Classroom/lecture hall/training room	
In a penitentiary	0.89
Otherwise	0.71
Computer room, data center	0.94
Conference/meeting/multipurpose room	0.97
Copy/print room	0.31

**TABLE C405.3.2(2)—continued
INTERIOR LIGHTING POWER ALLOWANCES:
SPACE-BY-SPACE METHOD**

COMMON SPACE TYPES*	LPD (watts/ft ²)
Corridor	
In a facility for the visually impaired (and not used primarily by the staff) ^b	0.71
In a hospital	0.71
Otherwise	0.41
Courtroom	1.20
Dining area	
In bar/lounge or leisure dining	0.86
In cafeteria or fast food dining	0.40
In a facility for the visually impaired (and not used primarily by the staff) ^b	1.27
In family dining	0.60
In a penitentiary	0.42
Otherwise	0.43
Electrical/mechanical room	0.43
Emergency vehicle garage	0.52
Food preparation area	1.09
Guestroom ^{c, d}	0.41
Laboratory	
In or as a classroom	1.11
Otherwise	1.33
Laundry/washing area	0.53
Loading dock, interior	0.88
Lobby	
For an elevator	0.65
In a facility for the visually impaired (and not used primarily by the staff) ^b	1.69
In a hotel	0.51
In a motion picture theater	0.23
In a performing arts theater	1.25
Otherwise	0.84
Locker room	0.52
Lounge/breakroom	
In a healthcare facility	0.42
Otherwise	0.59
Office	
Enclosed	0.74
Open plan	0.61
Parking area, interior	0.15
Pharmacy area	1.66
Restroom	
In a facility for the visually impaired (and not used primarily by the staff) ^b	1.26
Otherwise	0.63
Sales area	1.05

**TABLE C405.3.2(2)—continued
INTERIOR LIGHTING POWER ALLOWANCES:
SPACE-BY-SPACE METHOD**

COMMON SPACE TYPES*	LPD (watts/ft ²)
Seating area, general	0.23
Stairwell	0.49
Storage room	0.38
Vehicular maintenance area	0.60
Workshop	1.26
BUILDING TYPE SPECIFIC SPACE TYPES*	LPD (watts/ft ²)
Automotive (see Vehicular maintenance area)	
Convention Center—exhibit space	0.61
Dormitory—living quarters ^{c, d}	0.50
Facility for the visually impaired ^b	
In a chapel (and not used primarily by the staff)	0.70
In a recreation room (and not used primarily by the staff)	1.77
Fire Station—sleeping quarters ^c	0.23
Gymnasium/fitness center	
In an exercise area	0.90
In a playing area	0.85
Healthcare facility	
In an exam/treatment room	1.40
In an imaging room	0.94
In a medical supply room	0.62
In a nursery	0.92
In a nurse's station	1.17
In an operating room	2.26
In a patient room ^c	0.68
In a physical therapy room	0.91
In a recovery room	1.25
Library	
In a reading area	0.96
In the stacks	1.18
Manufacturing facility	
In a detailed manufacturing area	0.80
In an equipment room	0.76
In an extra-high-bay area (greater than 50 feet floor-to-ceiling height)	1.42
In a high-bay area (25–50 feet floor-to-ceiling height)	1.24
In a low-bay area (less than 25 feet floor-to-ceiling height)	0.86
Museum	
In a general exhibition area	0.31
In a restoration room	1.10
Performing arts theater—dressing room	0.41
Post office—sorting area	0.76

TABLE C405.3.2(2)—continued
INTERIOR LIGHTING POWER ALLOWANCES:
SPACE-BY-SPACE METHOD

COMMON SPACE TYPES*	LPD (watts/ft ²)
Religious buildings	
In a fellowship hall	0.54
In a worship/pulpit/choir area	0.85
Retail facilities	
In a dressing/fitting room	0.51
In a mall concourse	0.82
Sports arena—playing area	
For a Class I facility ^e	2.94
For a Class II facility ^f	2.01
For a Class III facility ^g	1.30
For a Class IV facility ^h	0.86
Transportation facility	
At a terminal ticket counter	0.51
In a baggage/carousel area	0.39
In an airport concourse	0.25
Warehouse—storage area	
For medium to bulky, palletized items	0.33
For smaller, hand-carried items	0.69

The exterior lighting design will be based on the building location and the applicable “Lighting Zone” as defined in IECC 2021 Table C405.5.2(1) which follows. This table is identical to IECC 2018 Table C405.4.2(1) and IECC 2021.

**TABLE C405.5.2(1)
EXTERIOR LIGHTING ZONES**

LIGHTING ZONE	DESCRIPTION
1	Developed areas of national parks, state parks, forest land, and rural areas
2	Areas predominantly consisting of residential zoning, neighborhood business districts, light industrial with limited nighttime use and residential mixed-use areas
3	All other areas not classified as lighting zone 1, 2 or 4
4	High-activity commercial districts in major metropolitan areas as designated by the local land use planning authority

The lighting power density savings will be based on reductions below the allowable design levels as specified in IECC 2015 Table C405.5.2(2) or 2018 Table C405.2.2(2) or IECC 2021 Table C405.52(2).

Allowable Design Levels from IECC 2015

TABLE C405.5.2(2)
INDIVIDUAL LIGHTING POWER ALLOWANCES FOR BUILDING EXTERIORS

	LIGHTING ZONES				
	Zone 1	Zone 2	Zone 3	Zone 4	
Base Site Allowance (Base allowance is usable in tradable or nontradable surfaces.)	500 W	600 W	750 W	1300 W	
Tradable Surfaces (Lighting power densities for uncovered parking areas, building grounds, building entrances and exits, canopies and overhangs and outdoor sales areas are tradable.)	Uncovered Parking Areas				
	Parking areas and drives	0.04 W/ft ²	0.06 W/ft ²	0.10 W/ft ²	0.13 W/ft ²
	Building Grounds				
	Walkways less than 10 feet wide	0.7 W/linear foot	0.7 W/linear foot	0.8 W/linear foot	1.0 W/linear foot
	Walkways 10 feet wide or greater, plaza areas special feature areas	0.14 W/ft ²	0.14 W/ft ²	0.16 W/ft ²	0.2 W/ft ²
	Stairways	0.75 W/ft ²	1.0 W/ft ²	1.0 W/ft ²	1.0 W/ft ²
	Pedestrian tunnels	0.15 W/ft ²	0.15 W/ft ²	0.2 W/ft ²	0.3 W/ft ²
	Building Entrances and Exits				
	Main entries	20 W/linear foot of door width	20 W/linear foot of door width	30 W/linear foot of door width	30 W/linear foot of door width
	Other doors	20 W/linear foot of door width	20 W/linear foot of door width	20 W/linear foot of door width	20 W/linear foot of door width
	Entry canopies	0.25 W/ft ²	0.25 W/ft ²	0.4 W/ft ²	0.4 W/ft ²
	Sales Canopies				
	Free-standing and attached	0.6 W/ft ²	0.6 W/ft ²	0.8 W/ft ²	1.0 W/ft ²
	Outdoor Sales				
	Open areas (including vehicle sales lots)	0.25 W/ft ²	0.25 W/ft ²	0.5 W/ft ²	0.7 W/ft ²
Street frontage for vehicle sales lots in addition to "open area" allowance	No allowance	10 W/linear foot	10 W/linear foot	30 W/linear foot	
Nontradable Surfaces (Lighting power density calculations for the following applications can be used only for the specific application and cannot be traded between surfaces or with other exterior lighting. The following allowances are in addition to any allowance otherwise permitted in the "Tradable Surfaces" section of this table.)	Building facades	No allowance	0.075 W/ft ² of gross above-grade wall area	0.113 W/ft ² of gross above-grade wall area	0.15 W/ft ² of gross above-grade wall area
	Automated teller machines (ATM) and night depositories	270 W per location plus 90 W per additional ATM per location	270 W per location plus 90 W per additional ATM per location	270 W per location plus 90 W per additional ATM per location	270 W per location plus 90 W per additional ATM per location
	Entrances and gatehouse inspection stations at guarded facilities	0.75 W/ft ² of covered and uncovered area	0.75 W/ft ² of covered and uncovered area	0.75 W/ft ² of covered and uncovered area	0.75 W/ft ² of covered and uncovered area
	Loading areas for law enforcement, fire, ambulance and other emergency service vehicles	0.5 W/ft ² of covered and uncovered area	0.5 W/ft ² of covered and uncovered area	0.5 W/ft ² of covered and uncovered area	0.5 W/ft ² of covered and uncovered area
	Drive-up windows/doors	400 W per drive-through	400 W per drive-through	400 W per drive-through	400 W per drive-through
	Parking near 24-hour retail entrances	800 W per main entry	800 W per main entry	800 W per main entry	800 W per main entry

For SI: 1 foot = 304.8 mm, 1 watt per square foot = W/0.0929 m².
W = watts.

Allowable Design Levels from IECC 2018

Table C405.2.2(2)
Lighting Power Allowances for Building Exteriors

	Zone 0	Zone 1	Zone 2	Zone 3	Zone 4
Base Site Allowance (Base allowance may be used in tradable or nontradable surfaces.)					
	No allowance	350 W	400 W	500 W	900 W
Tradable Surfaces (LPD allowances for uncovered parking areas, building grounds, building entrances, exits and loading docks, canopies and overhangs, and outdoor sales areas may be traded.)					
Uncovered Parking Areas					
Parking areas and drives	No allowance	0.03 W/ft ²	0.04 W/ft ²	0.06 W/ft ²	0.08 W/ft ²
Building Grounds					
Walkways/ramps less than 10 ft wide	No allowance	0.5 W/linear foot	0.5 W/linear foot	0.6 W/linear foot	0.7 W/linear foot
Walkways/ramps 10 ft wide or greater Plaza areas Special feature areas	No allowance	0.10 W/ft ²	0.10 W/ft ²	0.11 W/ft ²	0.14 W/ft ²
Dining areas	No allowance	0.65 W/ft ²	0.65 W/ft ²	0.75 W/ft ²	0.95 W/ft ²
Stairways	No allowance	0.6 W/ft ²	0.7 W/ft ²	0.7 W/ft ²	0.7 W/ft ²
Pedestrian tunnels	No allowance	0.12 W/ft ²	0.12 W/ft ²	0.14 W/ft ²	0.21 W/ft ²
Landscaping	No allowance	0.03 W/ft ²	0.04 W/ft ²	0.04 W/ft ²	0.04 W/ft ²
Building Entrances, Exits, and Loading Docks					
Pedestrian and vehicular entrances and exits	No allowance	14 W/lin ft of opening	14 W/lin ft of opening	21 W/lin ft of opening	21 W/lin ft of opening
Entry canopies	No allowance	0.20 W/ft ²	0.25 W/ft ²	0.4 W/ft ²	0.4 W/ft ²
Loading docks	No allowance	0.35 W/ft ²	0.35 W/ft ²	0.35 W/ft ²	0.35 W/ft ²
Sales Canopies					
Free standing and attached	No allowance	0.4 W/ft ²	0.4 W/ft ²	0.6 W/ft ²	0.7 W/ft ²
Outdoor Sales					
Open areas (including vehicle sales lots)	No allowance	0.2 W/ft ²	0.2 W/ft ²	0.35 W/ft ²	0.5 W/ft ²
Street frontage for vehicle sales lots in addition to "open area" allowance	No allowance	No allowance	7 W/linear foot	7 W/linear foot	21 W/linear foot

TABLE C405.4.2(3)
INDIVIDUAL LIGHTING POWER ALLOWANCES FOR BUILDING EXTERIORS

LIGHTING ZONES				
	Zone 1	Zone 2	Zone 3	Zone 4
Building facades	No allowance	0.075 W/ft ² of gross above-grade wall area	0.113 W/ft ² of gross above-grade wall area	0.15 W/ft ² of gross above-grade wall area
Automated teller machines (ATM) and night depositories	135 W per location plus 45 W per additional ATM per location			
Uncovered entrances and gatehouse inspection stations at guarded facilities	0.5 W/ft ² of area			
Uncovered loading areas for law enforcement, fire, ambulance and other emergency service vehicles	0.35 W/ft ² of area			
Drive-up windows and doors	200 W per drive through			
Parking near 24-hour retail entrances.	400 W per main entry			

For SI: For SI: 1 watt per square foot = W/0.0929 m².

W = watts.

Allowable Design Levels from IECC 2021

TABLE C405.5.2(2)
LIGHTING POWER ALLOWANCES FOR BUILDING EXTERIORS

	LIGHTING ZONES			
	Zone 1	Zone 2	Zone 3	Zone 4
Base Site Allowance	350 W	400 W	500 W	900 W
Uncovered Parking Areas				
Parking areas and drives	0.03 W/ft ²	0.04 W/ft ²	0.06 W/ft ²	0.08 W/ft ²
Building Grounds				
Walkways and ramps less than 10 feet wide	0.50 W/linear foot	0.50 W/linear foot	0.60 W/linear foot	0.70 W/linear foot
Walkways and ramps 10 feet wide or greater, plaza areas, special feature areas	0.10 W/ft ²	0.10 W/ft ²	0.11 W/ft ²	0.14 W/ft ²
Dining areas	0.65 W/ft ²	0.65 W/ft ²	0.75 W/ft ²	0.95 W/ft ²
Stairways	0.60 W/ft ²	0.70 W/ft ²	0.70 W/ft ²	0.70 W/ft ²
Pedestrian tunnels	0.12 W/ft ²	0.12 W/ft ²	0.14 W/ft ²	0.21 W/ft ²
Landscaping	0.03 W/ft ²	0.04 W/ft ²	0.04 W/ft ²	0.04 W/ft ²
Building Entrances and Exits				
Pedestrian and vehicular entrances and exits	14 W/linear foot of opening	14 W/linear foot of opening	21 W/linear foot of opening	21 W/linear foot of opening
Entry canopies	0.20 W/ft ²	0.25 W/ft ²	0.40 W/ft ²	0.40 W/ft ²
Loading docks	0.35 W/ft ²	0.35 W/ft ²	0.35 W/ft ²	0.35 W/ft ²
Sales Canopies				
Free-standing and attached	0.40 W/ft ²	0.40 W/ft ²	0.60 W/ft ²	0.70 W/ft ²
Outdoor Sales				
Open areas (including vehicle sales lots)	0.20 W/ft ²	0.20 W/ft ²	0.35 W/ft ²	0.50 W/ft ²
Street frontage for vehicle sales lots in addition to "open area" allowance	No allowance	7 W/linear foot	7 W/linear foot	21 W/linear foot

For SI: 1 foot = 304.8 mm, 1 watt per square foot = W/0.0929 m².
W = watts.

TABLE C405.5.2(3)
INDIVIDUAL LIGHTING POWER ALLOWANCES FOR BUILDING EXTERIORS

	LIGHTING ZONES			
	Zone 1	Zone 2	Zone 3	Zone 4
Building facades	No allowance	0.075 W/ft ² of gross above-grade wall area	0.113 W/ft ² of gross above-grade wall area	0.15 W/ft ² of gross above-grade wall area
Automated teller machines (ATM) and night depositories	135 W per location plus 45 W per additional ATM per location			
Uncovered entrances and gate-house inspection stations at guarded facilities	0.50 W/ft ² of area			
Uncovered loading areas for law enforcement, fire, ambulance and other emergency service vehicles	0.35 W/ft ² of area			
Drive-up windows and doors	200 W per drive through			
Parking near 24-hour retail entrances.	400 W per main entry			

For SI: For SI: 1 watt per square foot = W/0.0929 m².
W = watts.

MEASURE CODE: CI-LTG-LPDE-V10-250101

REVIEW DEADLINE: 1/1/2029

4.5.8 Miscellaneous Commercial/Industrial Lighting

DESCRIPTION

This measure is designed to calculate savings from energy efficient lighting upgrades that are not captured in other measures within the TRM. If a lighting project fits the measure description in other lighting measures, then those criteria, definitions, and calculations should be used.

Unlike other lighting measures this one applies only to RF applications (because there is no defined baseline for TOS or NC applications).

DEFINITION OF EFFICIENT EQUIPMENT

A lighting fixture that replaces an existing fixture to provide the same or greater lumen output at a lower kW consumption.

DEFINITION OF BASELINE EQUIPMENT

The definition of baseline equipment is the existing lighting fixture.

DEEMED LIFETIME OF EFFICIENT EQUIPMENT

The lifetime of the efficient equipment fixture is the rated fixture life divided by hours of use. If unknown the default lifetime for interior fixtures, regardless of program type is 15 years.¹²⁹²

For exterior fixtures, the lifetime is assumed to be 16 years for Dusk-to-Dawn (4303 hours) applications, or 25 years for Dusk-to-Business-Close Year Round (1609 hours) and Dusk-to-Business-Close Seasonal (<1000 hours).¹²⁹³

DEEMED MEASURE COST

The actual cost of the efficient light fixture should be used.

LOADSHAPE

- Loadshape C06 - Commercial Indoor Lighting
- Loadshape C07 - Grocery/Conv. Store Indoor Lighting
- Loadshape C08 - Hospital Indoor Lighting
- Loadshape C09 - Office Indoor Lighting
- Loadshape C10 - Restaurant Indoor Lighting
- Loadshape C11 - Retail Indoor Lighting
- Loadshape C12 - Warehouse Indoor Lighting
- Loadshape C13 - K-12 School Indoor Lighting
- Loadshape C14 - Indust. 1-shift (8/5) (e.g., comp. air, lights)
- Loadshape C15 - Indust. 2-shift (16/5) (e.g., comp. air, lights)
- Loadshape C16 - Indust. 3-shift (24/5) (e.g., comp. air, lights)
- Loadshape C17 - Indust. 4-shift (24/7) (e.g., comp. air, lights)
- Loadshape C18 - Industrial Indoor Lighting
- Loadshape C19 - Industrial Outdoor Lighting
- Loadshape C20 - Commercial Outdoor Lighting

¹²⁹² 15 years is used based on assumption that most product using this measure will be LED.

¹²⁹³ Exterior fixture measure lives are based upon review of the typical rated life of the fixtures, divided by the hours of use assumption and applying a derating factor of 15% to account for potential impacts from external installation (as proposed in a Guidehouse EUL methodology recommendation for Street Lights).

COINCIDENCE FACTOR

The summer peak coincidence factor for this measure is dependent on the location type. Values are provided for each building type in section 4.5.

Algorithm

CALCULATION OF SAVINGS

ELECTRIC ENERGY SAVINGS

$$\Delta kWh = ((Watts_{base} - Watts_{EE}) / 1000) * Hours * WHF_e * ISR$$

Where:

Watts_{base} = Input wattage of the existing system which depends on the baseline fixture configuration (number and type of lamp) and ballast factor (if applicable) and number of fixtures.

= Actual

Watts_{EE} = New Input wattage of EE fixture which depends on new fixture configuration (number of lamps) and ballast factor (if applicable) (if applicable) and number of fixtures.

= Actual

Hours = Average hours of use per year as provided by the customer or selected from the Reference Table in Section 4.5, Fixture annual operating hours, by building type. If hours or building type are unknown, use the Miscellaneous value.

WHF_e = Waste heat factor for energy to account for cooling energy savings from efficient lighting is selected from the Reference Table in Section 4.5 for each building type. If building is un-cooled, the value is 1.0.

ISR = In Service Rate or the percentage of units rebated that get installed.
 =100% if application form completed with sign off that equipment is not placed into storage.¹²⁹⁴ If sign off form not completed assume the following 3 year ISR assumptions:

Weighted Average 1st year In Service Rate (ISR)	2nd year Installations	3rd year Installations	Final Lifetime In Service Rate
93.4% ¹²⁹⁵	2.5%	2.1%	98.0% ¹²⁹⁶

HEATING PENALTY

If electrically heated building:

$$\Delta kWh_{heatpenalty}^{1297} = (((Watts_{Base} - Watts_{EE}) / 1000) * ISR * Hours * -IFkWh$$

Where:

¹²⁹⁴ Illinois evaluation of PY1 through PY3 has not found that fixtures or lamps placed into storage to be a significant enough issue to warrant including an "In-Service Rate" when commercial customers complete an application form.

¹²⁹⁵ Based on assumptions from 4.5.3 High Performance and Reduced Wattage T8 fixtures.

¹²⁹⁶ The 98% Lifetime ISR assumption is based upon review of two evaluations:

'Nexus Market Research, RLW Analytics and GDS Associates study; "New England Residential Lighting Markdown Impact Evaluation, January 20, 2009' and 'KEMA Inc, Feb 2010, Final Evaluation Report:, Upstream Lighting Program, Volume 1.' This implies that only 2% of bulbs purchased are never installed. The second and third year installations are based upon Ameren analysis of the Californian KEMA study showing that 54% of future installs occur in year 2 and 46% in year 3. The 2nd and 3rd year installations should be counted as part of those future program year savings.

¹²⁹⁷ Negative value because this is an increase in heating consumption due to the efficient lighting.

IFkWh = Lighting-HVAC Interaction Factor for electric heating impacts; this factor represents the increased electric space heating requirements due to the reduction of waste heat rejected by the efficient lighting. Values are provided in the Reference Table in Section 4.5. If unknown, use the Miscellaneous value.

DEFERRED INSTALLS

As presented above, if a sign off form is not completed the characterization assumes that a percentage of bulbs purchased are not installed until Year 2 and Year 3 (see ISR assumption above). The Illinois Technical Advisory Committee has determined the following methodology for calculating the savings of these future installs.

Year 1 (Purchase Year) installs: Characterized using assumptions provided above or evaluated assumptions if available.

Year 2 and 3 installs: Characterized using delta watts assumption and hours of use from the Install Year, i.e., the actual deemed (or evaluated if available) assumptions active in Year 2 and 3 should be applied.

The NTG factor for the Purchase Year should be applied.

SUMMER COINCIDENT DEMAND SAVINGS

$$\Delta kW = ((Watts_{base} - Watts_{EE}) / 1000) * WHF_d * CF * ISR$$

Where:

WHFd = Waste Heat Factor for Demand to account for cooling savings from efficient lighting in cooled buildings is selected from the Reference Table in Section 4.5 for each building type. If the building is not cooled WHFd is 1.

CF = Summer Peak Coincidence Factor for measure is selected from the Reference table in Section 4.5 for each building type. If the building type is unknown, use the Miscellaneous value of 0.66.

Other factors as defined above.

FOSSIL FUEL SAVINGS

$$\Delta Therms^{1298} = (((Watts_{Base} - Watts_{EE}) / 1000) * ISR * Hours * - IFTherms$$

Where:

IFTherms = Lighting-HVAC Integration Factor for gas heating impacts; this factor represents the increased gas space heating requirements due to the reduction of waste heat rejected by the efficient lighting. This value is selected from the Reference Table in Section 6.5 for each building type.

WATER IMPACT DESCRIPTIONS AND CALCULATION

N/A

DEEMED O&M COST ADJUSTMENT CALCULATION

If there are differences between the maintenance of the efficient and baseline lighting system then they should be evaluated on a project-by-project basis.

¹²⁹⁸Negative value because this is an increase in heating consumption due to the efficient lighting.

MEASURE CODE: CI-LTG-MSCI-V05-240101

REVIEW DEADLINE: 1/1/2026

4.5.9 Multi-Level Lighting Switch

DESCRIPTION

This measure relates to the installation new multi-level lighting switches on an existing lighting system.

This measure can only relate to the adding of a new control in an existing building, since multi-level switching is required in the Commercial new construction building energy code (IECC 2012/2015/2018/2021).

This measure was developed to be applicable to the following program types: RF.

If applied to other program types, the measure savings should be verified.

DEFINITION OF EFFICIENT EQUIPMENT

In order for this characterization to apply, the efficient system is assumed to be a lighting system controlled by multi-level lighting controls.

DEFINITION OF BASELINE EQUIPMENT

The baseline equipment is assumed to be an uncontrolled lighting system where all lights in a given area are on the same circuit or all circuits come on at the same time.

DEEMED LIFETIME OF EFFICIENT EQUIPMENT

The expected measure life for all lighting controls is assumed to be 10 years.¹²⁹⁹

DEEMED MEASURE COST

When available, the actual cost of the measure shall be used. When not available, the incremental capital cost for this measure is assumed to be \$274.¹³⁰⁰

LOADSHAPE

- Loadshape C06 - Commercial Indoor Lighting
- Loadshape C07 - Grocery/Conv. Store Indoor Lighting
- Loadshape C08 - Hospital Indoor Lighting
- Loadshape C09 - Office Indoor Lighting
- Loadshape C10 - Restaurant Indoor Lighting
- Loadshape C11 - Retail Indoor Lighting
- Loadshape C12 - Warehouse Indoor Lighting
- Loadshape C13 - K-12 School Indoor Lighting
- Loadshape C14 - Indust. 1-shift (8/5) (e.g., comp. air, lights)
- Loadshape C15 - Indust. 2-shift (16/5) (e.g., comp. air, lights)
- Loadshape C16 - Indust. 3-shift (24/5) (e.g., comp. air, lights)
- Loadshape C17 - Indust. 4-shift (24/7) (e.g., comp. air, lights)
- Loadshape C18 - Industrial Indoor Lighting
- Loadshape C19 - Industrial Outdoor Lighting
- Loadshape C20 - Commercial Outdoor Lighting

¹²⁹⁹ Consistent with Lighting control measure.

¹³⁰⁰ Goldberg et al, State of Wisconsin Public Service Commission of Wisconsin, Focus on Energy Evaluation, Business Programs: Incremental Cost Study, KEMA, October 28, 2009.

COINCIDENCE FACTOR

The summer peak coincidence factor for this measure is dependent on the location type. Values are provided for each building type in the reference section below.

Algorithm

CALCULATION OF SAVINGS

ELECTRIC ENERGY SAVINGS

$$\Delta kWh = KW_{Controlled} * Hours * ESF * WHF_e$$

Where:

$KW_{Controlled}$ = Total lighting load connected to the control in kilowatts.
 = Actual

Hours = total operating hours of the controlled lighting circuit before the lighting controls are installed. This number should be collected from the customer. Average hours of use per year are provided in the Reference Table in Section 4.5, Fixture annual operating hours, for each building type if customer specific information is not collected. If unknown building type, use the Miscellaneous value.

ESF = Energy Savings factor (represents the percentage reduction to the $KW_{controlled}$ due to the use of multi-level switching).
 = Dependent on building type:¹³⁰¹

Building Type	Energy Savings Factor (ESF)
Private Office	21.6%
Open Office	16.0%
Retail	14.8%
Classrooms	8.3%
Unknown, average	15%

WHF_e = Waste heat factor for energy to account for cooling energy savings from efficient lighting is provided in the Reference Table in Section 4.5 for each building type. If building is un-cooled, the value is 1.0.

HEATING PENALTY

If electrically heated building:

$$\Delta kWh_{heatpenalty}^{1302} = KW_{Controlled} * Hours * ESF * -IFkWh$$

Where:

IFkWh = Lighting-HVAC Interaction Factor for electric heating impacts; this factor represents the increased electric space heating requirements due to the reduction of waste heat rejected by the efficient lighting. Values are provided in the Reference Table in Section 4.5. If unknown, use the Miscellaneous value.

¹³⁰¹ Based on results from “Lighting Controls Effectiveness Assessment: Final Report on Bi-Level Lighting Study” published by the California Public Utilities Commission (CPUC), prepared by ADM Associates.

¹³⁰²Negative value because this is an increase in heating consumption due to the efficient lighting.

SUMMER COINCIDENT PEAK DEMAND SAVINGS

$$\Delta kW = KW_{\text{controlled}} * ESF * WHF_d * CF$$

Where:

WHF_d = Waste Heat Factor for Demand to account for cooling savings from efficient lighting in cooled buildings is provided in the Reference Table in Section 4.5. If the building is un-cooled WHF_d is 1.

CF = Summer Peak Coincidence Factor for measure is provided in the Reference Table in Section 4.5. If unknown, use the Miscellaneous value of 0.66.¹³⁰³

FOSSIL FUEL SAVINGS

$$\Delta \text{therms} = KW_{\text{Controlled}} * \text{Hours} * ESF * - \text{IFTherms}$$

Where:

IFTherms = Lighting-HVAC Integration Factor for gas heating impacts; this factor represents the increased gas space heating requirements due to the reduction of waste heat rejected by the efficient lighting and provided in the Reference Table in Section 4.5 by building type.

WATER IMPACT DESCRIPTIONS AND CALCULATION

N/A

DEEMED O&M COST ADJUSTMENT CALCULATION

N/A

MEASURE CODE: CI-LTG-MLLC-V06-230101

REVIEW DEADLINE: 1/1/2025

¹³⁰³ By applying the ESF and the same coincidence factor for general lighting savings we are in essence assuming that the savings from multi-level switching are as likely during peak periods as any other time. In the absence of better information this seems like a reasonable assumption and if anything may be on the conservative side since you might expect the peak periods to be generally sunnier and therefore more likely to have lower light levels. It is also consistent with the control type reducing the wattage lighting load, the same as the general lighting measures.

4.5.10 Lighting Controls

DESCRIPTION

This measure relates to the installation of new occupancy or daylighting sensors and controls on a new or existing lighting system. Lighting control types covered by this measure include wall, ceiling, fixture mounted or integrated controls in addition to Luminaire Level Lighting Controls (LLCs) or Networked Lighting Controls (NLC) which have additional high-end trim and networking capabilities. Passive infrared, ultrasonic detectors and fixture-mounted sensors or sensors with a combination thereof are eligible. Lighting controls required by state energy codes are not eligible. This must be a new installation with additional control features and may not solely be a replacement of an existing lighting control with the same control features.

This measure was developed to be applicable to the following program types: RF.

If applied to other program types, the measure savings should be verified.

DEFINITION OF EFFICIENT EQUIPMENT

Lighting that is controlled by any of the control strategies characterized in this measure; occupancy, daylighting or dual (occupancy and daylighting) controls with or without high-end trim, and Luminaire-level lighting controls (LLCs) / Networked Lighting Controls (NLC).

LLCs or NLCs are defined according to DesignLights Consortium (DLC) Networked Lighting Controls definition, which requires systems to have fixture networking capabilities, individual addressability, occupancy sensing, daylight harvesting, high-end trim, flexible zoning, continuous dimming, scheduling and cybersecurity. The network ability allows building managers to group lights with specific zonal control and scheduling strategies, energy monitoring and high-end trim resulting in a higher savings capability. While DLC listing is not a requirement for any control type characterized in this measure, programs should consider eligibility requirements including requiring at least the capability for network controlled occupancy, daylight harvesting and high-end trim to ensure quality product is installed achieving forecasted savings consistent with the measure assumptions below.

A subset of occupancy sensors are those that are programmed as “vacancy” sensors. To qualify as a vacancy sensor, the control must be configured such that manual input is required to turn on the controlled lighting and the control automatically turns the lighting off. Additional savings are achieved compared to standard occupancy sensors because lighting does not automatically turn on and occupants may decide to not turn it on. Note that vacancy sensors are not a viable option for many applications where standard occupancy sensors should be used instead.

DEFINITION OF BASELINE EQUIPMENT

The baseline is assumed to be the existing lighting system and can include manual or no controls or an existing control strategy that is being improved. Note where an existing inefficient fixture is replaced with an efficient fixture with control, use the fixture measure to calculate savings from the wattage reduction first, then assume the efficient fixture without control as the baseline for the control measure.

DEEMED LIFETIME OF EFFICIENT EQUIPMENT

The expected measure life for Luminaire-level lighting controls (LLCs) / Networked Lighting Controls (NLC) is assumed to be 15 years, consistent with the average expected lifetime of the fixture. For all other lighting controls, measure life is assumed to be 10 years.¹³⁰⁴

DEEMED MEASURE COST

When available, the actual cost of the measure shall be used. When not available, the following default values are provided:

¹³⁰⁴ Based on research conducted by Guidehouse, interviewing 46 contractors, reported in ‘ComEd Retrofit Add-On EUL Results Memo. January 27, 2020.

Lighting Control Type	Incremental Cost ¹³⁰⁵
Interior Wall Switch Occupancy Sensor	\$55.00
Interior Fixture-Mounted Occupancy Sensor	\$67.00
Interior Remote or Wall-Mounted Occupancy Sensor	\$125.00
Interior Fixture-Mounted Daylight Sensor	\$50.00
Interior Remote or Wall-Mounted Daylight Sensor	\$65.00
Interior Integrated Occupancy for LED Interior Fixtures < 10,000 Lumens	\$40.00
Interior Integrated Occupancy for LED Interior Fixtures >= 10,000 Lumens	\$40.00
Interior Integrated Dual Occupancy & Daylight Sensor for LED Interior Fixtures < 10,000 Lumens	\$50.00
Interior Integrated Dual Occupancy & Daylight Sensor for LED Interior Fixtures >= 10,000 Lumens	\$50.00
Interior Fixture-Mounted Dual Occupancy & Daylight Sensor for LED Interior Fixtures < 10,000 Lumens	\$ 100.00
Interior Fixture-Mounted Dual Occupancy & Daylight Sensor for LED Interior Fixtures >= 10,000 Lumens	\$ 100.00
Luminaire-Level Lighting Controls	\$56.00
Interior Networked Lighting Controls <10,000 sqft building	\$0.86 per ft ²
Interior Networked Lighting Controls 10,000-100,000 sqft building	\$0.59 per ft ²
Interior Networked Lighting Controls >100,000 sqft building	\$0.40 per ft ²
High End Trim or Institutional Tuning	\$0.06 per ft ²
Exterior Occupancy Sensor	\$82.00
Exterior NLC	Use actual

LOADSHAPE

- Loadshape C06 - Commercial Indoor Lighting
- Loadshape C07 - Grocery/Conv. Store Indoor Lighting
- Loadshape C08 - Hospital Indoor Lighting
- Loadshape C09 - Office Indoor Lighting
- Loadshape C10 - Restaurant Indoor Lighting
- Loadshape C11 - Retail Indoor Lighting
- Loadshape C12 - Warehouse Indoor Lighting
- Loadshape C13 - K-12 School Indoor Lighting
- Loadshape C14 - Indust. 1-shift (8/5) (e.g., comp. air, lights)
- Loadshape C15 - Indust. 2-shift (16/5) (e.g., comp. air, lights)
- Loadshape C16 - Indust. 3-shift (24/5) (e.g., comp. air, lights)
- Loadshape C17 - Indust. 4-shift (24/7) (e.g., comp. air, lights)
- Loadshape C18 - Industrial Indoor Lighting

¹³⁰⁵ Based on indicative product cost review as performed for Efficiency Vermont TRM. Cost assumption for Luminaire Level Lighting Controls is based on the average of ‘clever’ and ‘clever-hybrid’ LLLC incremental costs, including a per fixture contribution to the necessary gateway, servers and installation labor from Kisch et al, “2020 Luminaire Level Lighting Controls Incremental Cost Study”, Energy Solutions on behalf of NEEA, January 2021. Cost assumptions for Interior Networked Lighting Controls is based on the average of “office”, “warehouse”, and “retail” by building size from Schwartz et al., “The Value Proposition for Cost-Effective, Demand Responsive-Enabling Nonresidential Lighting System Retrofits in California Buildings”, Lawrence Berkeley National Laboratory and Energy Solutions prepared for California Energy Commission, April 2019. This includes both material and labor cost estimates.

Cost for High End Trim / Institutional Tuning is based on estimate provided by SlipStream based on field implementation.

- Loadshape C19 - Industrial Outdoor Lighting
- Loadshape C20 - Commercial Outdoor Lighting

COINCIDENCE FACTOR

The summer peak coincidence factor for this measure is dependent on building type and can be found in the Reference Table in Section 4.5.

Algorithm

CALCULATION OF SAVINGS

ELECTRIC ENERGY SAVINGS

$$\Delta kWh = KW_{Controlled} * Hours * (ESF_{EE} - ESF_{Base}) * WHF_e$$

Where:

$KW_{Controlled}$ = Total lighting load connected to the control in kilowatts. The total connected load per control should be collected from the customer or the default values presented below used. Note where an existing inefficient fixture is replaced with an efficient fixture with control, use the fixture measure to calculate savings from the wattage reduction first, then assume the efficient fixture without control as the baseline for the control measure.

Lighting Control Type ¹³⁰⁶	Wattage Unit	Default kW Controlled
Interior Wall Switch Occupancy Sensor	per control	0.084
Interior Fixture-Mounted Occupancy Sensor	per fixture	0.081
Interior Remote or Wall-Mounted Occupancy Sensor	per control	0.338
Interior Fixture-Mounted Daylight Sensor	per fixture	0.095
Interior Wall-Mounted Daylight Sensor	per control	0.239
Interior Integrated Occupancy for LED Interior Fixtures < 10,000 Lumens	per fixture	0.031
Interior Integrated Occupancy for LED Interior Fixtures >= 10,000 Lumens	per fixture	0.118
Interior Integrated Dual Occupancy & Daylight Sensor for LED Interior Fixtures < 10,000 Lumens	per control	0.031
Interior Integrated Dual Occupancy & Daylight Sensor for LED Interior Fixtures >= 10,000 Lumens	per control	0.118
Interior Fixture-Mounted Dual Occupancy & Daylight Sensor for LED Interior Fixtures < 10,000 Lumens	per control	0.031
Interior Fixture-Mounted Dual Occupancy & Daylight Sensor for LED Interior Fixtures >= 10,000 Lumens	per control	0.118
Interior Luminaire-Level Lighting Controls < 10,000 Lumens	per control	0.031
Interior Luminaire-Level Lighting Controls >= 10,000 Lumens	per control	0.118

¹³⁰⁶ Estimates of watts controlled are based on Efficiency Vermont data as provided in the 2018 TRM. Future evaluation should determine appropriate assumptions based on Illinois program data. Estimated kilowatts per sqft for interior networked lighting controls is based on the lighting power density (LPD) assumption in the Wisconsin Focus on Energy 2019 Technical Reference Manual and divided by 1000. To determine the total $KW_{Controlled}$ multiply by the controlled sqft. Either the total $KW_{Controlled}$ or the total sqft must be reported to estimate savings from interior networked lighting controls.

Lighting Control Type ¹³⁰⁶	Wattage Unit	Default kW Controlled
Interior Networked Lighting Controls	kilowatts controlled per sqft	0.00061
Refrigerated Case Occupancy Sensor – Freezer and Cooler	per control	0.090
Exterior Occupancy Sensor	per fixture	0.086
Exterior NLC	kilowatts controlled per sqft	Use actual

Hours = total operating hours of the controlled lighting circuit before the lighting controls are installed. This number should be collected from the customer if possible. If not possible, assume hours as prescribed below:

Control Type	General Building Type ¹³⁰⁷	Reference Table in Section 4.5 Mapped Building/Space Types	Hours
Networked Lighting Controls and Luminaire-Level Lighting Controls	Education	Childcare/Pre-School, College, Elementary School, High School	4,231
	Manufacturing	Manufacturing Facility	5,365
	Office	Office - High Rise - CAV no econ, Office - High Rise- CAV econ, Office- High Rise- VAV econ, Office- High Rise - FCU, Office- Low Rise, Office - Mid Rise	4,453
	Retail	Convenience Store, Drug Store, Grocery, Retail - Department Store, Retail - Strip Mall	6,936
	Warehouse	Warehouse	5,116
	All Other	All other building/space types in the Reference Table in Section 4.5	Use Fixture Annual Operating Hours in the Reference Table in Section 4.5
All other	All	All	Use Fixture Annual Operating Hours in the Reference Table in Section 4.5

ESF = Energy Savings Factor (represents the percentage reduction to the operating Hours from the non-controlled lighting system) from the new lighting controls installed. Where available and with building owner consent, custom savings from controls may be used via networked trending software. If unavailable or consent not provided, defaults are provided below which assume installation is appropriate to provide the savings described. For dual controls and fixtures with high-end trim this should be reviewed and verified via representative spot checks to ensure daylighting capabilities will provide savings and fixture tuning is being performed.¹³⁰⁸

¹³⁰⁷ These are the general building types and the inferred baseline operating hours reported in DesignLights Consortium and NEEA, “Energy Savings from Networked Lighting Control (NLC) Systems with and without LLLC” Energy Solutions, September 2020. The inferred operating hours for “Assembly”, “Healthcare”, and “Restaurant” were excluded due to the reported small sample size (n=3, n=2, n=3 respectively). The mapping of the general building types to the building/space types listed in Section 4.5 Reference Table was completed by Guidehouse Inc.

¹³⁰⁸ It is recommended that evaluation is performed to assess the extent to which daylighting and high-end trim benefits are appropriately utilized in the field.

Lighting Control Type	Energy Savings Factor ¹³⁰⁹
Fixture Measurement of Control savings through Networked Trending (Interior or Exterior)	Custom
Interior Occupancy Sensor (Switch, Wall, Fixture or Remote Mounted or Integrated in Fixture)	24% 37% with High End Trim
Interior Occupancy Sensor configured as "Vacancy Sensor" (Switch, Wall, Fixture or Remote Mounted or Integrated in Fixture)	31% 44% with High End Trim
Interior Daylight Sensor (Wall, Fixture or Remote Mounted)	28% 41% with High End Trim
Interior Dual Occupancy & Daylight Sensor (Integrated or Fixture Mounted)	38% 51% with High End Trim ¹³¹⁰
Interior Networked Luminaire-Level Lighting Controls	61% ¹³¹¹
Interior Networked Lighting Controls Only with No LLLCs	35%
Interior Networked Lighting Controls (unknown or mixed LLLCs)	49%
Refrigerated Case Occupancy Sensor – Freezer and Cooler	27%
Exterior Occupancy Sensor	41%
Exterior Networked Luminaire-Level Lighting Controls	61% ¹³¹²
Exterior Networked Lighting Controls Only with No LLLCs	35%

¹³⁰⁹ Interior controls % savings based except where noted on LBNL, Williams et al, "Lighting Controls in Commercial Buildings", 2012, p172. ESF for Vacancy Sensors is based on Papamichael, Konstantions, Bi-Level Switching in Office Spaces, California Lighting Technology Center, February 1,2010. See Figure 8 on page 10 for relevant study results. The study shows a 30% extra savings above a typical occupancy sensor; 24% * 1.3 = 31%.

ESF for Luminaire Level Lighting Controls, Networked Lighting Controls and the 13% High End Trim adder are based upon the weighted average of results from:

Pacific Northwest National Laboratory, "Evaluation of Advanced Lighting Control Systems in a Working Office Environment", November 2018.

Schuetter et al., "Cree SmartCast Lighting Retrofit Demonstration: LED Fixtures and Controls for Advanced Holistic Lighting Solutions", September 2020 (expected).

DesignLights Consortium and NEEA, "Energy Savings from Networked Lighting Control (NLC) Systems with and without LLLC" Energy Solutions, September 2020.. LLLC ESF used in weighted average is the average of all 98 sites with NLCs w/LLLC. NLC ESF is the average of all 194 buildings. High-end trim adder used for other lighting control types is based on the results for the 96 sites w NLCs w/o LLLC and using the "Other Control Strategies" savings where the baseline had influences from high-end trim removed.

Refrigerated Case occupancy sensors ESF is based on percentage of operating hours spent in low-power operation during vacant periods, found in SDG&E workpaper: WPSDGENRLG0027.

Exterior sensors are based upon data from "Application Assessment of Bi-Level LED Parking Lot Lighting" p6.

¹³¹⁰ The ESF_{EE} for interior dual occupancy & daylight sensor with high-end trim is estimated to be higher than the interior networked lighting control ESF_{EE} since this measure requires that the sensors be integrated or fixture mounted which has been documented to lead to higher savings than zone or wall sensors. The NLC measure is not specific to fixture, zone, or wall sensors.

¹³¹¹ The ESF_{EE} for LLLC is not separated out based on the inclusion of high-end trim since the DesignLights Consortium Technical Requirements Version NLC5 (1/25/21) requires that high-end trim is included for all interior networked lighting controls including LLLC.

¹³¹² In the absence of evaluation results specifically for exterior networked lighting controls with or without LLLCs, the same ESFs are assumed as the equivalent interior lighting controls. This is consistent with the value provided in 'Energy Savings Forecast of SolidState Lighting in General Illumination Application, Table F.4 - Building Exterior, DOE, 2019' which indicates a savings of 48% for Exterior NLCs (unknown LLC).

Lighting Control Type	Energy Savings Factor ¹³⁰⁹
Exterior Networked Lighting Controls (unknown or mixed LLLCs)	49%
No Lighting Control	0%

ESF_{Base} = Energy Savings Factor of the lighting controls that existed before the new lighting controls were installed. If prior existence of lighting controls is unknown, assume 0.

WHF_e = Waste heat factor for energy to account for cooling energy savings from efficient lighting is provided in the Reference Table in Section 4.5 for each building type. If building is un-cooled, the value is 1.0.

For example, a 1,000 sqft. low-rise office building, with cooling, installing 10 networked, interior fixture-mounted occupancy sensors would save:

$$\begin{aligned} \Delta kWh &= KW_{controlled} * HOURS * (ESF_{EE} - ESF_{Base}) * WHF_e \\ &= 0.81 * 4,453 * (24\% - 0\%) * 1.10 \\ &= 952.2 \text{ kWh} \end{aligned}$$

HEATING PENALTY

If electrically heated building:

$$\Delta kWh_{heatpenalty}^{1313} = KW_{Controlled} * Hours * (ESF_{EE} - ESF_{Base}) * -IFkWh$$

Where:

$IFkWh$ = Lighting-HVAC Interaction Factor for electric heating impacts; this factor represents the increased electric space heating requirements due to the reduction of waste heat rejected by the efficient lighting. Values are provided in the Reference Table in Section 4.5. If unknown, use the Miscellaneous value.

For example, a 1,000 sqft. low-rise office building, with electrical resistance heating, installing 10 networked, interior fixture-mounted occupancy sensors would have the following heating penalty:

$$\begin{aligned} \Delta kWh_{heatpenalty} &= KW_{controlled} * HOURS * (ESF_{ee} - ESF_{Base}) * -IfkWh \\ &= 0.81 * 4,453 * (24\% - 0\%) * -0.231 \\ &= -200 \text{ kWh} \end{aligned}$$

SUMMER COINCIDENT PEAK DEMAND SAVINGS

$$\Delta kW = KW_{controlled} * WHF_d * ((CF_{baseline} * BaseAdj) - CF_{LC})$$

Where:

WHF_d = Waste Heat Factor for Demand to account for cooling savings from efficient lighting in cooled buildings is provided in the Reference Table in Section 4.5. If the building is un-cooled WHF_d is 1.

¹³¹³ Negative value because this is an increase in heating consumption due to the efficient lighting.

CF_{baseline} = Baseline Summer Peak Coincidence Factor for the lighting system without lighting controls installed selected from the Reference Table in Section 4.5 for each building type. If the building type is unknown, use the Miscellaneous value of 0.66

BaseAdj = Assume 0.5 if existing lighting controls, 1.0 if no existing controls

CF_{LC} = Retrofit Summer Peak Coincidence Factor the lighting system with lighting controls installed is 0.15 regardless of building type.¹³¹⁴

For controls on exterior fixtures $\Delta kW = 0$

For example, a 1,000 sqft. low-rise office building, with no existing lighting controls, installing 10 networked, interior fixture-mounted occupancy sensors would save:

$$\begin{aligned} \Delta kW &= KW_{\text{controlled}} * WHF_d * ((Cf_{\text{baseline}} * BaseAdj) - CF_{LC}) \\ &= 0.81 * 1.26 * ((0.52 * 1) - 0.15) \\ &= 0.38 \text{ kW} \end{aligned}$$

FOSSIL FUEL SAVINGS

$$\Delta \text{therms} = KW_{\text{Controlled}} * \text{Hours} * (ESF_{EE} - ESF_{\text{Base}}) * -IF_{\text{Therms}}$$

Where:

IF_{Therms} = Lighting-HVAC Integration Factor for gas heating impacts; this factor represents the increased gas space heating requirements due to the reduction of waste heat rejected by the efficient lighting and provided in the Reference Table in Section 4.5 by building type.

For example, a 1,000 sqft. low-rise office building installing 10 networked, interior fixture-mounted occupancy sensors would save:

$$\begin{aligned} \Delta \text{Therms} &= KW_{\text{Controlled}} * \text{HOURS} * (ESF_{EE} - ESF_{\text{Base}}) * -IF_{\text{Therms}} \\ &= 0.81 * 4,453 * (24\% - 0\%) * -0.01 \\ &= -8.7 \text{ therms} \end{aligned}$$

WATER IMPACT DESCRIPTIONS AND CALCULATION

N/A

DEEMED O&M COST ADJUSTMENT CALCULATION

N/A

MEASURE CODE: CI-LTG-OSLC-V09-250101

REVIEW DEADLINE: 1/1/2026

¹³¹⁴ Coincidence Factor Study Residential and Commercial Industrial Lighting Measures, RLW Analytics, Spring 2007. Note, the connected load used in the calculation of the CF for occupancy sensor lights includes the average ESF.

4.5.11 Solar Light Tubes

DESCRIPTION

A tubular skylight which is 10” to 21” in diameter with a prismatic or translucent lens is installed on the roof of a commercial facility. The lens reflects light captured from the roof opening through a highly specular reflective tube down to the mounted fixture height. When in use, a light tube fixture resembles a metal halide fixture. Uses include grocery, school, retail and other single story commercial buildings.

In order that the savings characterized below apply, the electric illumination in the space must be automatically controlled to turn off or down when the tube is providing enough light.

This measure was developed to be applicable to the following program types: TOS, NC, RF.

If applied to other program types, the measure savings should be verified.

DEFINITION OF EFFICIENT EQUIPMENT

The efficient equipment is assumed to be a tubular skylight that concentrates and directs light from the roof to an area inside the facility.

DEFINITION OF BASELINE EQUIPMENT

The baseline equipment for this measure is a fixture with comparable luminosity. The specifications for the baseline lamp depend on the size of the Light Tube being installed.

DEEMED LIFETIME OF EFFICIENT EQUIPMENT

The estimated useful life for a light tube commercial skylight is 10 years.¹³¹⁵

DEEMED MEASURE COST

If available, the actual incremental cost should be used. For analysis purposes, assume an incremental cost for a light tube commercial skylight is \$750.¹³¹⁶

LOADSHAPE

Loadshape C14 - Indust. 1-shift (8/5) (e.g., comp. air, lights)¹³¹⁷

COINCIDENCE FACTOR

The summer peak coincidence factor for this measure is dependent on location.

Algorithm

CALCULATION OF SAVINGS

ELECTRIC ENERGY SAVINGS

$$\Delta kWh = kW_f * HOURS * WHFe$$

Where:

kW_f = Connected load of the fixture the solar tube replaces

¹³¹⁵ Equal to the manufacturers standard warranty.

¹³¹⁶ Based on review of solar lighting installers websites (e.g., elitesolarsystems.com).

¹³¹⁷ The savings from solar light tubes are only realized during the sunlight hours. It is therefore appropriate to apply the single shift (8/5) loadshape to this measure.

Size of Tube	Average Lumen output for Chicago Illinois (minimum) ¹³¹⁸	Equivalent fixture	kW
21"	9,775 (4,179)	50% 3 x 2 32W lamp CFL (207W, 9915 lumens) 50% 4 lamp F32 w/Elec 4' T8 (114W, 8895 lumens)	0.161
14"	4,392 (1,887)	50% 2 42W lamp CFL (94W, 4406 lumens) 50% 2 lamp F32 w/Elec 4' T8 (59W, 4448 lumens)	0.077
10"	2,157 (911)	50% 1 42W lamp CFL (46W, 2203 lumens) 50% 1 lamp F32 w/Elec 4' T8 (32W, 2224 lumens)	0.039
		AVERAGE	0.092

HOURS = Equivalent full load hours
= 2400¹³¹⁹

WHF_e = Waste heat factor for energy to account for cooling energy savings from efficient lighting is selected from the Reference Table in Section 4.5 for each building type. If building is un-cooled, the value is 1.0.

HEATING PENALTY

If electrically heated building:

$$\Delta kWh_{\text{heatpenalty}}^{1320} = kW_f * \text{HOURS} * -IFkWh$$

Where:

IFkWh = Lighting-HVAC Interaction Factor for electric heating impacts; this factor represents the increased electric space heating requirements due to the reduction of waste heat rejected by the efficient lighting. Values are provided in the Reference Table in Section 4.5. If unknown, use the Miscellaneous value.

SUMMER COINCIDENT PEAK DEMAND SAVINGS

$$\Delta kW = \Delta kW_f * WHFd * CF$$

Where:

WHFd = Waste Heat Factor for Demand to account for cooling savings from efficient lighting in cooled buildings is selected from the Reference Table in Section 4.5 for each building type. If the building is not cooled WHFd is 1.

CF = Summer Peak Coincidence Factor for measure is selected from the Reference Table in Section 4.5 for each building type. If the building type is unknown, use the Miscellaneous value of 0.66.

FOSSIL FUEL SAVINGS

$$\Delta \text{Therms}^{1321} = \Delta kW_f * \text{HOURS} * -IF\text{Therms}$$

Where:

IFTherms = Lighting-HVAC Integration Factor for gas heating impacts; this factor represents the increased gas space heating requirements due to the reduction of waste heat rejected by

¹³¹⁸ Solatube Test Report (2005). http://www.maine绿色建筑.com/files/file/solatube/stb_lumens_datasheet.pdf.

¹³¹⁹ Ibid. The lumen values presented in the kW table represent the average of the lightest 2400 hours.

¹³²⁰ Negative value because this is an increase in heating consumption due to the efficient lighting.

¹³²¹ Negative value because this is an increase in heating consumption due to the efficient lighting.

the efficient lighting. Please select from the Reference Table in Section 4.5 for each building type.

WATER IMPACT DESCRIPTIONS AND CALCULATION

N/A

DEEMED O&M COST ADJUSTMENT CALCULATION

N/A

MEASURE CODE: CI-LTG-STUB-V03-200101

REVIEW DEADLINE: 1/1/2025

4.5.12 T5 Fixtures and Lamps

DESCRIPTION

T5 Lamp/ballast systems have higher lumens per watt than a standard T8 or an existing T8 or T12 system. The smaller lamp diameter allows for better optical systems, and more precise control of lighting. These characteristics result in light fixtures that produce equal or greater light than standard T8 or T12 fixtures, while using fewer watts.

This measure applies to the installation of new equipment with efficiencies that exceed that of the equipment that would have been installed following standard market practices and is applicable to time of sale as well as retrofit measures.

If the implementation strategy does not allow for the installation location to be known, a deemed split of 99% Commercial and 1% Residential should be used.¹³²²

This measure was developed to be applicable to the following program types: TOS, EREP, DI.

If applied to other program types, the measure savings should be verified.

The measure applies to all commercial T5 installations excluding new construction and substantial renovation or change of use measures (see lighting power density measure). Lookup tables have been provided to account for various installations. Actual existing equipment wattages should be compared to new fixture wattages whenever possible while maintaining lumen equivalent designs. Default new and baseline assumptions are provided if existing equipment cannot be determined. Actual costs and hours of use should be utilized when available. Default component costs and lifetimes have been provided for Operating and Maintenance Calculations. Please see the Definition Table to determine applicability for each program. Configurations not included in the TRM may be included in custom program design using the provided algorithms as long as energy savings is achieved. The following table defines the applicability for different programs:

Time of Sale (TOS)	Early Replacement (EREP) and DI
This program applies to installations where customer and location of equipment is not known, or at time of burnout of existing equipment. T5 Lamp/ballast systems have higher lumens per watt than a standard T8 system. The smaller lamp diameter allows for better optical systems, and more precise control of lighting. These characteristics result in light fixtures that produce equal or greater light than standard T8 fixtures, while using fewer watts.	For installations that upgrade installations before the end of their useful life. T5 Lamp/ballast systems have higher lumens per watt than a standard T8 or T12 system. The smaller lamp diameter allows for better optical systems, and more precise control of lighting. These characteristics result in light fixtures that produce equal or greater light than standard T8 or T12 fixtures, while using fewer watts and having longer life.

DEFINITION OF EFFICIENT EQUIPMENT

The definition of efficient equipment varies based on the program and is defined below:

Time of Sale (TOS)	Early Replacement (EREP) and DI
4' fixtures must use a T5 lamp and ballast configuration. 1' and 3' lamps are not eligible. High Performance Troffers must be 85% efficient or greater. T5 HO high bay fixtures must be 3, 4 or 6 lamps and 90% efficient or better.	4' fixtures must use a T5 lamp and ballast configuration. 1' and 3' lamps are not eligible. High Performance Troffers must be 85% efficient or greater. T5 HO high bay fixtures must be 3, 4 or 6 lamps and 90% efficient or better.

¹³²² Based on weighted average of Final ComEd’s BILD program data from PY5 and PY6. For Residential installations, hours of use assumptions from ‘5.5 Interior Hardwired Compact Fluorescent Lamp (CFL) Fixture’ measure should be used.

DEFINITION OF BASELINE EQUIPMENT

The definition of baseline equipment varies based on the program and is defined below:

Time of Sale (TOS)	Early Replacement (EREP) and DI
<p>The baseline is T8 with equivalent lumen output. In high-bay applications, the baseline is pulse start metal halide systems.</p>	<p>The baseline is the existing system. In July 14, 2012, Federal Standards were enacted that were expected to eliminate T-12s as an option for linear fluorescent fixtures. Through v3.0 of the TRM, it was assumed that the T-12 would no longer be baseline for retrofits from 1/1/2016. However, due to significant loopholes in the legislation, T-12 compliant product is still freely available and in Illinois T-12s continue to hold a significant share of the existing and replacement lamp market. Therefore the timing of the sunseting of T-12s as a viable baseline has been pushed back in v7.0 until 1/1/2020 and will be revisited in future update sessions. There will be a baseline shift applied to all measures installed before 2020 in years remaining in the measure life. See table C-1.</p>

DEEMED LIFETIME OF EFFICIENT EQUIPMENT

The lifetime of the efficient equipment fixture should be the rated life of the fixture divided by hours of use. If unknown default is, regardless of program type is 12 years.¹³²³

LOADSHAPE

- Loadshape C06 - Commercial Indoor Lighting
- Loadshape C07 - Grocery/Conv. Store Indoor Lighting
- Loadshape C08 - Hospital Indoor Lighting
- Loadshape C09 - Office Indoor Lighting
- Loadshape C10 - Restaurant Indoor Lighting
- Loadshape C11 - Retail Indoor Lighting
- Loadshape C12 - Warehouse Indoor Lighting
- Loadshape C13 - K-12 School Indoor Lighting
- Loadshape C14 - Indust. 1-shift (8/5) (e.g., comp. air, lights)
- Loadshape C15 - Indust. 2-shift (16/5) (e.g., comp. air, lights)
- Loadshape C16 - Indust. 3-shift (24/5) (e.g., comp. air, lights)
- Loadshape C17 - Indust. 4-shift (24/7) (e.g., comp. air, lights)
- Loadshape C18 - Industrial Indoor Lighting
- Loadshape C19 - Industrial Outdoor Lighting
- Loadshape C20 - Commercial Outdoor Lighting

¹³²³ 12 years is based on average of mostly CEE lamp products (9 years), T5 lamps (10.7 years) and GDS Measure Life Report, June 2007, (15 years), as recommended in Navigant ‘ComEd Effective Useful Life Research Report’, May 2018.

Algorithm

CALCULATION OF SAVINGS

ELECTRIC ENERGY SAVINGS

$$\Delta kWh = ((Watts_{base} - Watts_{EE}) / 1000) * Hours * WHF_e * ISR$$

Where:

Watts_{base} = Input wattage of the existing system which depends on the baseline fixture configuration (number and type of lamp) and number of fixtures. Value can be selected from the appropriate reference table as shown below, of a custom value can be entered if the configurations in the tables is not representative of the existing system.

Watts_{EE} = New Input wattage of EE fixture which depends on new fixture configuration (number of lamps) and ballast factor and number of fixtures. Value can be selected from the appropriate reference table as shown below, of a custom value can be entered if the configurations in the tables is not representative of the existing system.

Program	Reference Table
Time of Sale	A-1: T5 New and Baseline Assumptions
Early Replacement, DI	A-2: T5 New and Baseline Assumptions

Hours = Average hours of use per year as provided by the customer or selected from the Reference Table in Section 4.5, Fixture annual operating hours, by building type. If hours or building type are unknown, use the Miscellaneous value.

WHF_e = Waste heat factor for energy to account for cooling energy savings from efficient lighting is selected from the Reference Table in Section 4.5 for each building type. If building is un-cooled, the value is 1.0.

ISR = In Service Rate or the percentage of units rebated that get installed.
 =100%¹³²⁴ if application form completed with sign off that equipment is not placed into storage. If sign off form not completed assume the following 3 year ISR assumptions:

Weighted Average 1 st year In Service Rate (ISR)	2 nd year Installations	3 rd year Installations	Final Lifetime In Service Rate
98% ¹³²⁵	0%	0%	98.0% ¹³²⁶

HEATING PENALTY

If electrically heated building:

$$\Delta kWh_{heatpenalty}^{1327} = (((Watts_{Base} - Watts_{EE}) / 1000) * ISR * Hours * -IFkWh$$

¹³²⁴Illinois evaluation of PY1 through PY3 has not found that fixtures or lamps placed into storage to be a significant enough issue to warrant including an "In-Service Rate" when commercial customers complete an application form.

¹³²⁵ 1st year in service rate is based upon review of PY5-6 evaluations from ComEd's commercial lighting program (BILD) (see 'IL Commercial Lighting ISR_2014.xls' for more information.

¹³²⁶ The 98% Lifetime ISR assumption is based upon review of two evaluations: 'Nexus Market Research, RLW Analytics and GDS Associates study; "New England Residential Lighting Markdown Impact Evaluation, January 20, 2009' and 'KEMA Inc, Feb 2010, Final Evaluation Report: Upstream Lighting Program, Volume 1.' This implies that only 2% of bulbs purchased are never installed. The second and third year installations are based upon Ameren analysis of the Californian KEMA study showing that 54% of future installs occur in year 2 and 46% in year 3. The 2nd and 3rd year installations should be counted as part of those future program year savings.

¹³²⁷Negative value because this is an increase in heating consumption due to the efficient lighting.

Where:

IFkWh = Lighting-HVAC Interaction Factor for electric heating impacts; this factor represents the increased electric space heating requirements due to the reduction of waste heat rejected by the efficient lighting. Values are provided in the Reference Table in Section 4.5. If unknown, use the Miscellaneous value.

SUMMER COINCIDENT DEMAND SAVINGS

$$\Delta kW = ((Watts_{base} - Watts_{EE}) / 1000) * WHF_d * CF * ISR$$

Where:

WHF_d = Waste Heat Factor for Demand to account for cooling savings from efficient lighting in cooled buildings is selected from the Reference Table in Section 4.5 for each building type. If the building is not cooled WHF_d is 1.

CF = Summer Peak Coincidence Factor for measure is selected from the Reference Table in Section 4.5 for each building type. If the building type is unknown, use the Miscellaneous value.

FOSSIL FUEL SAVINGS

$$\Delta Therms^{1328} = (((Watts_{Base} - Watts_{EE}) / 1000) * ISR * Hours * - IF_{Therms}$$

Where:

IF_{Therms} = Lighting-HVAC Integration Factor for gas heating impacts; this factor represents the increased gas space heating requirements due to the reduction of waste heat rejected by the efficient lighting. This value is selected from the Reference Table in Section 4.5 for each building type.

WATER IMPACT DESCRIPTIONS AND CALCULATION

N/A

DEEMED O&M COST ADJUSTMENT CALCULATION

See Reference tables for Operating and Maintenance Values

Program	Reference Table
Time of Sale	B-1: T5 Component Costs and Lifetime
Early Replacement, DI	B-2: T5 Component Costs and Lifetime

REFERENCE TABLES

See following page.

¹³²⁸Negative value because this is an increase in heating consumption due to the efficient lighting.

A-1: Time of Sale: T5 New and Baseline Assumptions¹³²⁹

EE Measure Description	EE Cost	Watts _{EE}	Baseline Description	Base Cost	Watts _{BASE}	Measure Cost	Watts _{SAVE}
2-Lamp T5 High-Bay	\$200.00	180	200 Watt Pulse Start Metal-Halide	\$100.00	232	\$100.00	52
3-Lamp T5 High-Bay	\$200.00	180	200 Watt Pulse Start Metal-Halide	\$100.00	232	\$100.00	52
4-Lamp T5 High-Bay	\$225.00	240	320 Watt Pulse Start Metal-Halide	\$125.00	350	\$100.00	110
6-Lamp T5 High-Bay	\$250.00	360	Proportionally Adjusted according to 6-Lamp HPT8 Equivalent to 320 PSMH	\$150.00	476	\$100.00	116
1-Lamp T5 Troffer/Wrap	\$100.00	32	Proportionally adjusted according to 2-Lamp T5 Equivalent to 3-Lamp T8	\$60.00	44	\$40.00	12
2-Lamp T5 Troffer/Wrap	\$100.00	64	3-Lamp F32T8 Equivalent w/ Elec. Ballast	\$60.00	88	\$40.00	24
1-Lamp T5 Industrial/Strip	\$70.00	32	Proportionally adjusted according to 2-Lamp T5 Equivalent to 3-Lamp T8	\$40.00	44	\$30.00	12
2-Lamp T5 Industrial/Strip	\$70.00	64	3-Lamp F32T8 Equivalent w/ Elec. Ballast	\$40.00	88	\$30.00	24
3-Lamp T5 Industrial/Strip	\$70.00	96	Proportionally adjusted according to 2-Lamp T5 Equivalent to 3-Lamp T8	\$40.00	132	\$30.00	36
4-Lamp T5 Industrial/Strip	\$70.00	128	Proportionally adjusted according to 2-Lamp T5 Equivalent to 3-Lamp T8	\$40.00	178	\$30.00	50
1-Lamp T5 Indirect	\$175.00	32	Proportionally adjusted according to 2-Lamp T5 Equivalent to 3-Lamp T8	\$145.00	44	\$30.00	12
2-Lamp T5 Indirect	\$175.00	64	3-Lamp F32T8 Equivalent w/ Elec. Ballast	\$145.00	88	\$30.00	24

¹³²⁹ Adapted from Efficiency Vermont Technical Reference User Manual (TRM) Measure Savings Algorithms and Cost Assumptions, October 26, 2011.

A-2: T5 New and Baseline Assumptions¹³³⁰

EE Measure Description	EE Cost	Watts _{EE}
3-Lamp T5 High-Bay	\$200.00	180
4-Lamp T5 High-Bay	\$225.00	234
6-Lamp T5 High-Bay	\$250.00	358
1-Lamp T5 Troffer/Wrap	\$100.00	32
2-Lamp T5 Troffer/Wrap	\$100.00	64
1-Lamp T5 Industrial/Strip	\$70.00	32
2-Lamp T5 Industrial/Strip	\$70.00	64
3-Lamp T5 Industrial/Strip	\$70.00	96
4-Lamp T5 Industrial/Strip	\$70.00	128
1-Lamp T5 Indirect	\$175.00	32
2-Lamp T5 Indirect	\$175.00	64

Baseline Description	Watts _{BASE}
200 Watt Pulse Start Metal-Halide	232
250 Watt Metal-Halide	295
320 Watt Pulse Start Metal-Halide	350
400 Watt Metal-Halide	455
400 Watt Pulse Start Metal-Halide	476
1-Lamp F34T12 w/ EEMag Ballast	40
2-Lamp F34T12 w/ EEMag Ballast	68
3-Lamp F34T12 w/ EEMag Ballast	110
4-Lamp F34T12 w/ EEMag Ballast	139
1-Lamp F40T12 w/ EEMag Ballast	48
2-Lamp F40T12 w/ EEMag Ballast	82
3-Lamp F40T12 w/ EEMag Ballast	122
4-Lamp F40T12 w/ EEMag Ballast	164
1-Lamp F40T12 w/ Mag Ballast	57
2-Lamp F40T12 w/ Mag Ballast	94
3-Lamp F40T12 w/ Mag Ballast	147
4-Lamp F40T12 w/ Mag Ballast	182
1-Lamp F32T8	32
2-Lamp F32T8	59
3-Lamp F32T8	88
4-Lamp F32T8	114

¹³³⁰bid.

B-1: Time of Sale T5 Component Costs and Lifetime¹³³¹

EE Measure Description	EE Lamp Cost	EE Lamp Life (hrs)	EE Lamp Rep. Labor Cost per lamp	EE Ballast Cost	EE Ballast Life (hrs)	EE Ballast Rep. Labor Cost	Baseline Description	# Base Lamps	Base Lamp Cost	Base Lamp Life (hrs)	Base Lamp Rep. Labor Cost	# Base Ballasts	Base Ballast Cost	Base Ballast Life (hrs)	Base Ballast Rep. Labor Cost
3-Lamp T5 High-Bay	\$12.00	20000	\$6.67	\$52.00	70000	\$22.50	200 Watt Pulse Start Metal-Halide	1.00	\$21.00	10000	\$6.67	1.00	\$87.75	40000	\$22.50
4-Lamp T5 High-Bay	\$12.00	20000	\$6.67	\$52.00	70000	\$22.50	320 Watt Pulse Start Metal-Halide	1.00	\$21.00	20000	\$6.67	1.00	\$109.35	40000	\$22.50
6-Lamp T5 High-Bay	\$12.00	20000	\$6.67	\$52.00	70000	\$22.50	Adjusted according to 6-Lamp HPT8 Equivalent to 320	1.36	\$21.00	20000	\$6.67	1.50	\$109.35	40000	\$22.50
1-Lamp T5 Troffer/Wrap	\$12.00	20000	\$2.67	\$52.00	70000	\$15.00	Proportionally adjusted according to 2-Lamp T5 Equivalent to 3-Lamp T8	1.50	\$2.50	20000	\$2.67	0.50	\$15.00	70000	\$15.00
2-Lamp T5 Troffer/Wrap	\$12.00	20000	\$2.67	\$52.00	70000	\$15.00	3-Lamp F32T8 Equivalent w/ Elec. Ballast	3.00	\$2.50	20000	\$2.67	1.00	\$15.00	70000	\$15.00
1-Lamp T5 Industrial/Strip	\$12.00	20000	\$2.67	\$52.00	70000	\$15.00	Proportionally adjusted according to 2-Lamp T5 Equivalent to 3-Lamp T8	1.50	\$2.50	20000	\$2.67	0.50	\$15.00	70000	\$15.00
2-Lamp T5 Industrial/Strip	\$12.00	20000	\$2.67	\$52.00	70000	\$15.00	3-Lamp F32T8 Equivalent w/ Elec. Ballast	3.00	\$2.50	20000	\$2.67	1.00	\$15.00	70000	\$15.00
3-Lamp T5 Industrial/Strip	\$12.00	20000	\$2.67	\$52.00	70000	\$15.00	Proportionally adjusted according to 2-Lamp T5 Equivalent	4.50	\$2.50	20000	\$2.67	1.50	\$15.00	70000	\$15.00
4-Lamp T5 Industrial/Strip	\$12.00	20000	\$2.67	\$52.00	70000	\$15.00	Proportionally adjusted according to 2-Lamp T5 Equivalent to 3-Lamp T8	6.00	\$2.50	20000	\$2.67	2.00	\$15.00	70000	\$15.00
1-Lamp T5 Indirect	\$12.00	20000	\$2.67	\$52.00	70000	\$15.00	Proportionally adjusted according to 2-Lamp T5 Equivalent to 3-Lamp T8	1.50	\$2.50	20000	\$2.67	0.50	\$15.00	70000	\$15.00
2-Lamp T5 Indirect	\$12.00	20000	\$2.67	\$52.00	70000	\$15.00	3-Lamp F32T8 Equivalent w/ Elec. Ballast	3.00	\$2.50	20000	\$2.67	1.00	\$15.00	70000	\$15.00

¹³³¹ Adapted from Efficiency Vermont Technical Reference User Manual (TRM) Measure Savings Algorithms and Cost Assumptions, October 26, 2011.

B-2: T5

Component Costs and Lifetime¹³³²

EE Measure Description	EE Lamp Cost	EE Lamp Life (hrs)	EE Lamp Rep. Labor Cost per lamp	EE Ballast Cost	EE Ballast Life (hrs)	EE Ballast Rep. Labor Cost	Baseline Description	# Base Lamps	Base Lamp Cost	Base Lamp Life (hrs)	Base Lamp Rep. Labor Cost	# Base Ballasts	Base Ballast Cost	Base Ballast Life (hrs)	Base Ballast Rep. Labor Cost
3-Lamp T5 High-Bay	\$12.00	20000	\$6.67	\$52.00	70000	\$22.50	200 Watt Pulse Start Metal-Halide	1.00	\$21.00	10000	\$6.67	1.00	\$ 88	40000	\$22.50
							250 Watt Metal Halide	1.00	\$21.00	10000	\$6.67	1.00	\$ 92	40000	\$22.50
4-Lamp T5 High-Bay	\$12.00	20000	\$6.67	\$52.00	70000	\$22.50	320 Watt Pulse Start Metal-Halide	1.00	\$72.00	20000	\$6.67	1.00	\$ 109	40000	\$22.50
							400 Watt Metal Halide	1.00	\$17.00	20000	\$6.67	1.00	\$ 114	40000	\$22.50
6-Lamp T5 High-Bay	\$12.00	20000	\$6.67	\$52.00	70000	\$22.50	Proportionally Adjusted according to 6-Lamp HPT8 Equivalent to 320 PSMH	1.36	\$72.00	20000	\$6.67	1.50	\$ 109	40000	\$22.50
1-Lamp T5 Troffer/Wrap	\$12.00	20000	\$2.67	\$52.00	70000	\$15.00	Proportionally adjusted according to 2-Lamp T5 Equivalent to 3-Lamp T8	1.50	\$2.50	20000	\$2.67	0.50	\$ 15	70000	\$15.00
2-Lamp T5 Troffer/Wrap	\$12.00	20000	\$2.67	\$52.00	70000	\$15.00	3-Lamp F32T8 Equivalent w/ Elec. Ballast	3.00	\$2.50	20000	\$2.67	1.00	\$ 15	70000	\$15.00
1-Lamp T5 Industrial/Strip	\$12.00	20000	\$2.67	\$52.00	70000	\$15.00	Proportionally adjusted according to 2-Lamp T5 Equivalent to 3-Lamp T8	1.50	\$2.50	20000	\$2.67	0.50	\$ 15	70000	\$15.00
2-Lamp T5 Industrial/Strip	\$12.00	20000	\$2.67	\$52.00	70000	\$15.00	3-Lamp F32T8 Equivalent w/ Elec. Ballast	3.00	\$2.50	20000	\$2.67	1.00	\$ 15	70000	\$15.00
3-Lamp T5 Industrial/Strip	\$12.00	20000	\$2.67	\$52.00	70000	\$15.00	Proportionally adjusted according to 2-Lamp T5 Equivalent to 3-Lamp T8	4.50	\$2.50	20000	\$2.67	1.50	\$ 15	70000	\$15.00
4-Lamp T5 Industrial/Strip	\$12.00	20000	\$2.67	\$52.00	70000	\$15.00	Proportionally adjusted according to 2-Lamp T5 Equivalent to 3-Lamp T8	6.00	\$2.50	20000	\$2.67	2.00	\$ 15	70000	\$15.00
1-Lamp T5 Indirect	\$12.00	20000	\$2.67	\$52.00	70000	\$15.00	Proportionally adjusted according to 2-Lamp T5 Equivalent to 3-Lamp T8	1.50	\$2.50	20000	\$2.67	0.50	\$ 15	70000	\$15.00
2-Lamp T5 Indirect	\$12.00	20000	\$2.67	\$52.00	70000	\$15.00	3-Lamp F32T8 Equivalent w/ Elec. Ballast	3.00	\$2.50	20000	\$2.67	1.00	\$ 15	70000	\$15.00

¹³³² Efficiency Vermont Technical Reference User Manual (TRM) Measure Savings Algorithms and Cost Assumptions, October 26, 2011 EPE Program Downloads. (Copy of LSF_2012_v4.04_250rows.xls). Kuiken et al, Focus on Energy Evaluation. Business Programs: Deemed Savings Manual v1.0, Kema, March 22, 2010.

C-1: T12 Baseline Adjustment:

For early replacement measures replacing existing T12 fixtures the full savings (as calculated above in the Algorithm section) will be claimed for the remaining useful life of the T12 fixture. This should be calculated as follows:

$$\text{RUL of existing T12 fixture} = (1/3 * 40,000)/\text{Hours.}$$

A savings adjustment should then be applied to the annual savings for the remainder of the measure life. The adjustment to be applied for each measure should be calculated as:

$$\% \text{ Adjustment} = (\text{TOS Base Watts} - \text{Efficient Watts}) / (\text{Existing T12 Watts} - \text{Efficient Watts})$$

The adjustment to be applied for each default measure described above is listed in the reference table below:

Savings Adjustment Factors

	watts	Equivalent T12 watts adjusted for lumen equivalency-34 w and 40 w with EEMag ballast	Equivalent T12 watts adjusted for lumen equivalency-40 w with EEMag ballast	Equivalent T12 watts adjusted for lumen equivalency-40 w with Mag ballast	Prportionally Adjusted for Lumens wattage for T8 equivalent
1-Lamp T5 Industrial/Strip	32	61	73	82	44
2-Lamp T5 Industrial/Strip	64	103	125	135	88
3-Lamp T5 Industrial/Strip	96	167	185	211	132
4-Lamp T5 Industrial/Strip	128	211	249	226	178
		Savings Factor Adjustment to the T8 baseline	Savings Factor Adjustment to the T8 baseline	Savings Factor Adjustment to the T8 baseline	
1-Lamp T5 Industrial/Strip		42%	29%	24%	
2-Lamp T5 Industrial/Strip		61%	40%	34%	
3-Lamp T5 Industrial/Strip		51%	40%	31%	
4-Lamp T5 Industrial/Strip		60%	41%	51%	

MEASURE CODE: CI-LTG-T5FX-V08-200101

REVIEW DEADLINE: 1/1/2025

4.5.13 Occupancy Controlled Bi-Level Lighting Fixtures

DESCRIPTION

This measure relates to replacing existing uncontrolled continuous lighting fixtures with new bi-level lighting fixtures. This measure can only relate to replacement in an existing building, since multi-level switching is required in the Commercial new construction building energy code (IECC 2012/2015/2018/2021). This measure is limited to 24/7 operation.

This measure was developed to be applicable to the following program types: RF.

If applied to other program types, the measure savings should be verified.

DEFINITION OF EFFICIENT EQUIPMENT

In order for this characterization to apply, the efficient system is assumed to be an occupancy controlled lighting fixture operating 24/7, that reduces light level during unoccupied periods.

DEFINITION OF BASELINE EQUIPMENT

The baseline equipment is assumed to be an uncontrolled lighting system on continuously, e.g. in stairwells and corridors for health and safety reasons.

DEEMED LIFETIME OF EFFICIENT EQUIPMENT

The expected measure life for all lighting controls is assumed to be 10 years.¹³³³

DEEMED MEASURE COST

When available, the actual cost of the measure shall be used. When not available, the assumed measure cost is \$274.¹³³⁴

LOADSHAPE

- Loadshape C06 - Commercial Indoor Lighting
- Loadshape C07 - Grocery/Conv. Store Indoor Lighting
- Loadshape C08 - Hospital Indoor Lighting
- Loadshape C09 - Office Indoor Lighting
- Loadshape C10 - Restaurant Indoor Lighting
- Loadshape C11 - Retail Indoor Lighting
- Loadshape C12 - Warehouse Indoor Lighting
- Loadshape C13 - K-12 School Indoor Lighting
- Loadshape C14 - Indust. 1-shift (8/5) (e.g., comp. air, lights)
- Loadshape C15 - Indust. 2-shift (16/5) (e.g., comp. air, lights)
- Loadshape C16 - Indust. 3-shift (24/5) (e.g., comp. air, lights)
- Loadshape C17 - Indust. 4-shift (24/7) (e.g., comp. air, lights)
- Loadshape C18 - Industrial Indoor Lighting
- Loadshape C19 - Industrial Outdoor Lighting
- Loadshape C20 - Commercial Outdoor Lighting

¹³³³ Consistent with Lighting Controls measure.

¹³³⁴ Consistent with the Multi-level Fixture measure with reference to Goldberg et al, State of Wisconsin Public Service Commission of Wisconsin, Focus on Energy Evaluation, Business Programs: Incremental Cost Study, KEMA, October 28, 2009. Also consistent with field experience of about \$250 per fixture and \$25 install labor.

COINCIDENCE FACTOR

The summer peak coincidence factor for this measure is dependent on the location type. Values are provided for each building type in the reference section below.

Algorithm

CALCULATION OF SAVINGS

ELECTRIC ENERGY SAVINGS

$$\Delta kWh = (KW_{Baseline} - (KW_{Controlled} * (1 - ESF))) * Hours * WHF_e$$

Where:

$KW_{Baseline}$ = Total baseline lighting load of the existing/baseline fixture
 = Actual

Note that if the existing fixture is only being retrofit with bi-level occupancy controls and not being replaced $KW_{Baseline}$ will equal $KW_{Controlled}$.

$KW_{Controlled}$ = Total controlled lighting load at full light output of the new bi-level fixture
 = Actual

Hours = Number of hours lighting is on. This measure is limited to 24/7 operation.
 = 8,766

ESF = Energy Savings factor (represents the percentage reduction to the $KW_{Controlled}$ due to the occupancy control).
 = % Standby Mode * (1 - % Full Light at Standby Mode)

% Standby Mode = Represents the percentage of the time the fixture is operating in standby (i.e. low-wattage) mode.

% Full Light at Standby Mode = Represents the assumed wattage consumption during standby mode relative to the full wattage consumption. Can be achieved either through dimming or a stepped control strategy.

= Dependent on application. If participant provided or metered data is available for both or either of these inputs a custom savings factor should be calculated. If not defaults are provided below:

Application	% Standby Mode	% Full Light at Standby Mode	Energy Savings Factor (ESF)
Stairwells	78.5% ¹³³⁵	50%	39.3%
		33%	52.6%
		10%	70.7%
		5%	74.6%
Corridors	50.0% ¹³³⁶	50%	25.0%
		33%	33.5%
		10%	45.0%

¹³³⁵ Average found from the four buildings in the State of California Energy Commission Lighting Research Program Bi-Level Stairwell Fixture Performance Final Report, October 2005.

¹³³⁶ Value determined from the Pacific Gas and Electric Company: Bi-Level Lighting Control Credits study for Interior Corridors of Hotels, Motels and High Rise Residential, June 2002.

Application	% Standby Mode	% Full Light at Standby Mode	Energy Savings Factor (ESF)
		5%	47.5%
Other 24/7 Space Type	50.0% ¹³³⁷	50%	25.0%
		33%	33.5%
		10%	45.0%
		5%	47.5%

WHF_e = Waste heat factor for energy to account for cooling energy savings from efficient lighting is provided in the Reference Table in Section 4.5 for each building type. If building is un-cooled, the value is 1.0.

HEATING PENALTY

If electrically heated building:

$$\Delta kWh_{\text{heatpenalty}}^{1338} = (KW_{\text{Baseline}} - (KW_{\text{Controlled}} * (1 - ESF))) * \text{Hours} * -IFkWh$$

Where:

IFkWh = Lighting-HVAC Interaction Factor for electric heating impacts; this factor represents the increased electric space heating requirements due to the reduction of waste heat rejected by the efficient lighting. Values are provided in the Reference Table in Section 4.5. If unknown, use the Miscellaneous value.

SUMMER COINCIDENT PEAK DEMAND SAVINGS

$$\Delta kW = (KW_{\text{Baseline}} - (KW_{\text{Controlled}} * (1 - ESF))) * WHF_d * (CF_{\text{baseline}} - CF_{\text{os}})$$

Where:

WHF_d = Waste Heat Factor for Demand to account for cooling savings from efficient lighting in cooled buildings is provided in the Reference Table in Section 4.5. If the building is un-cooled WHF_d is 1.

CF_{baseline} = Baseline Summer Peak Coincidence Factor for the lighting system without Occupancy Sensors installed.
= 1.0 (due to 24/7 operation)

CF_{os} = Retrofit Summer Peak Coincidence Factor the lighting system with Occupancy Sensors installed.
= 0.15 regardless of building type.¹³³⁹

NATURAL GAS HEATING PENALTY

If natural gas heating:

$$\Delta \text{therms} = (KW_{\text{Baseline}} - (KW_{\text{Controlled}} * (1 - ESF))) * \text{Hours} * -IF\text{Therms}$$

Where:

IFTherms = Lighting-HVAC Integration Factor for gas heating impacts; this factor represents the increased gas space heating requirements due to the reduction of waste heat rejected by the efficient lighting and provided in the Reference Table in Section 4.5 by building type.

¹³³⁷ Conservative estimate.

¹³³⁸ Negative value because this is an increase in heating consumption due to the efficient lighting.

¹³³⁹ Coincidence Factor Study Residential and Commercial Industrial Lighting Measures, RLW Analytics, Spring 2007. Note, the connected load used in the calculation of the CF for occupancy sensor lights includes the average ESF.

WATER IMPACT DESCRIPTIONS AND CALCULATION

N/A

DEEMED O&M COST ADJUSTMENT CALCULATION

N/A

MEASURE CODE: CI-LTG-OCBL-V06-240101

REVIEW DEADLINE: 1/1/2030

4.5.14 Commercial ENERGY STAR Specialty Compact Fluorescent Lamp (CFL) – Retired 12/31/2018, Removed in v8

4.5.15 LED Open Sign

DESCRIPTION

LED open signs must replace an existing neon open sign. LED drivers can be either electronic switching or linear magnetic, with the electronic switching supplies being the most efficient. The on/off power switch may be found on either the power line or load side of the driver, with the line side location providing significantly lower standby losses when the sign is turned off and is not operating. All new open signs must meet UL-84 (UL-844) requirements.

Replacement signs cannot use more than 20% of the input power of the sign that is being replaced.

This measure was developed to be applicable to the following program types: RF.

If applied to other program types, the measure savings should be verified.

DEFINITION OF EFFICIENT EQUIPMENT

The efficient product is an LED type illuminated open sign.

DEFINITION OF BASELINE EQUIPMENT

The baseline equipment is a neon type illuminated open sign.

DEEMED LIFETIME OF EFFICIENT EQUIPMENT

The estimated useful life is 15 years.¹³⁴⁰

DEEMED MEASURE COST

The actual measure installation cost should be used (including material and labor).

LOADSHAPE

- Loadshape C06 - Commercial Indoor Lighting
- Loadshape C07 - Grocery/Conv. Store Indoor Lighting
- Loadshape C08 - Hospital Indoor Lighting
- Loadshape C09 - Office Indoor Lighting
- Loadshape C10 - Restaurant Indoor Lighting
- Loadshape C11 - Retail Indoor Lighting
- Loadshape C12 - Warehouse Indoor Lighting
- Loadshape C13 - K-12 School Indoor Lighting
- Loadshape C14 - Indust. 1-shift (8/5) (e.g., comp. air, lights)
- Loadshape C15 - Indust. 2-shift (16/5) (e.g., comp. air, lights)
- Loadshape C16 - Indust. 3-shift (24/5) (e.g., comp. air, lights)
- Loadshape C17 - Indust. 4-shift (24/7) (e.g., comp. air, lights)
- Loadshape C18 - Industrial Indoor Lighting
- Loadshape C19 - Industrial Outdoor Lighting
- Loadshape C20 - Commercial Outdoor Lighting

COINCIDENCE FACTOR

The summer peak coincidence factor for this measure is dependent on the location type. Values are provided for each building type in the reference section in Section 4.5.

Algorithm

¹³⁴⁰ 15 years from GDS Measure Life Report, June 2007.

CALCULATION OF ENERGY SAVINGS

ELECTRIC ENERGY SAVINGS

The following equation was used to determine the energy savings from installing LED open signs:

$$\Delta kWh = (Watts_{base} - Watts_{ee}) / 1,000 * Hours * WHFe$$

Where:

Watts _{base}	= Wattage of neon sign with magnetic high voltage transformer = Actual; if unknown use 46.0W ¹³⁴¹
Watts _{ee}	= Wattage of LED sign with low voltage transformer = Actual; if unknown use 14.9W ¹³⁴²
Hours	= Annual hours of operation, assumed to be consistent with operating hours. Values are provided in the Reference Table in Section 4.5.
WHFe	= Waste heat factor for energy to account for cooling energy savings from efficient lighting are provided below for each building type in the Reference Table in Section 4.5. If unknown, use the Miscellaneous value.

HEATING PENALTY

If electrically heated building:

$$\Delta kWh_{heatpenalty}^{1343} = ((Watts_{base} - Watts_{EE}) / 1000) * Hours * -IFkWh$$

Where:

IFkWh	= Lighting-HVAC Interaction Factor for electric heating impacts; this factor represents the increased electric space heating requirements due to the reduction of waste heat rejected by the efficient lighting. Values are provided in the Reference Table in Section 4.5. If unknown, use the Miscellaneous value.
-------	--

DEMAND SAVINGS

$$\Delta kW = ((Watts_{base} - Watt_{see}) / 1000) * CF * WHF_d$$

Where:

WHFd	= Waste Heat Factor for Demand to account for cooling savings from efficient lighting in cooled buildings is provided in Reference Table in Section 4.5. If unknown, use the Miscellaneous value.
CF	= Summer Peak Coincidence Factor for measure is provided in the Reference Table in Section 4.5. If unknown, use the Miscellaneous value.
Other variables as provided above.	

Based on defaults provided above, the deemed energy savings are provided below:

Electric Energy and Coincident Peak Demand Savings

¹³⁴¹ Measured average demand data. Southern California Edison, "Replace Neon Open Sign with LED Open Sign", Workpaper SCE13LG070, Revision 2, October 2015. Pg. 10.

¹³⁴² Ibid.

¹³⁴³ Negative value because this is an increase in heating consumption due to the efficient lighting.

Building Types ¹³⁴⁴	Energy Savings (kWh)	$\Delta kWh_{\text{heatpenalty}}$ (if electric heat)	Coincident Demand Savings (kW)
Convenience Store	158	-120	0.0298
Grocery	152	-74	0.0277
Healthcare Clinic	169	-17	0.0374
Hotel/Motel - Common	229	-143	0.0282
Movie Theater	121	-73	0.0227
Restaurant	203	-85	0.0277
Retail - Department Store	191	-88	0.0387
Miscellaneous	115	-55	0.0245

FOSSIL FUEL SAVINGS

Heating Penalty if fossil fuel heated building (or if heating fuel is unknown):

$$\Delta \text{Therms}^{1345} = ((\text{WattsBase} - \text{WattsEE}) / 1000) * \text{Hours} * \text{IFTherms}$$

Where:

IFTherms = Lighting-HVAC Interaction Factor for gas heating impacts; this factor represents the increased gas space heating requirements due to the reduction of waste heat rejected by the efficient lighting. Values are provided in the Reference Table in Section 4.5. If unknown, use the Miscellaneous value.

Other factors as defined above

Based on defaults provided above, the deemed penalty is provided below:

Building Type	$\Delta \text{Therms}_{\text{heatpenalty}}$ (if gas heat)
Convenience Store	-5.1
Grocery	-3.2
Healthcare Clinic	-0.7
Hotel/Motel - Common	-6.1
Movie Theater	-3.2
Restaurant	-3.6
Retail - Department Store	-3.7
Miscellaneous	-2.3

WATER AND OTHER NON-ENERGY IMPACT DESCRIPTIONS AND CALCULATION

N/A

DEEMED O&M COST ADJUSTMENT CALCULATION

N/A

MEASURE CODE: CI-LTG-OPEN-V02-220101

REVIEW DEADLINE: 1/1/2026

¹³⁴⁴ Savings can be calculated for additional building types using the default values provided in the Reference Table in Section 4.5.

¹³⁴⁵ Negative value because this is an increase in heating consumption due to the efficient lighting.

4.5.16 LED Streetlighting

DESCRIPTION

Existing streetlights are retrofitted to be illuminated with light emitting diodes (LED) instead of less efficient lamps. Incentive applies for the replacement or retrofit of existing streetlights with new LED lamps.

This measure was developed to be applicable to the following program types: EREP, TOS*. If applied to other program types, the measure savings should be verified.

* It is recommended to consider likely high freeridership for time of sale applications of this measure.

DEFINITION OF EFFICIENT EQUIPMENT

The efficient equipment is the installed LED streetlight.

DEFINITION OF BASELINE EQUIPMENT

For TOS, baseline is assumed to be High Pressure Sodium lamp.

For early replacement, the baseline equipment is the existing streetlight for its' remaining useful life, and a new baseline High Pressure Sodium lamp for the remainder of the measure life. Where the existing fixture is Mercury Vapor (MV), the following table provides the deemed alignment of Mercury Vapor (MV) fixtures to High Pressure Sodium (HPS) for calculation of the midlife baseline adjustment.¹³⁴⁶

MV Lamp Watts	MV System Watts	HPS Lamp Watts	HPS System Watts
100	125	50	66
175	205	100	138
250	290	100	138
400	455/469	250	295
1000	1075	400	465

DEEMED LIFETIME OF EFFICIENT EQUIPMENT

The assumed effective useful life (EUL) of a new LED streetlight is 20 years for standard operation or 10 years for 8766 hour lighting.¹³⁴⁷

For early replacement, it is assumed the existing unit has a remaining useful life (RUL) of 3 years for standard operation and 1.5 year for 8760 operation.¹³⁴⁸

DEEMED MEASURE COST

The actual measure installation cost should be used (including material and labor). The assumed deferred cost (after 3 years for standard operation and 1.5 year for 8760 operation) of replacing the existing lamp with a new High

¹³⁴⁶ Midlife adjustment data is based on analysis by Guidehouse and is based on two years of AIC and ComEd program data, including 13,270 MV lamps and 96,780 HPS lamps. Both types of retrofits are mapped to the installed LED wattage, the resulting LED correlations are then used as a common frame of reference to align MV fixtures to the closest HPS equivalent. Results are further validated through the lumen equivalence method which confirms the alignments match the next closest lamp wattage, even if some HPS fixtures equate to higher lumen output whereas others provide lower output.

¹³⁴⁷ Based on research conducted by Guidehouse and reported in "ComEd LED St Lighting EUL Results Memo," January 27, 2020, Guidehouse reviewed a cross-section of products covered in 2019 energy conservation programs; these fixtures include the most commonly selected manufacturers and output spanning from 4,000 to 25,000 lumens. This review found that manufacturers for the majority of LED streetlights installed through programs in IL have recently doubled the expected rated life to 100,000 hours.

¹³⁴⁸ Assuming an existing mercury vapor ballast with a typical rated life of 40,000. Assuming 1/3 remaining useful life and standard operation this equates to $40,000/3/4303 = 3$ year remaining life, and $40,000/3/8760 = 1.5$ year remaining life for 8760 operation.

Pressure Sodium lamp is assumed to be \$44.¹³⁴⁹ This cost should be discounted to present value using the nominal discount rate.

LOADSHAPE

Loadshape C20 - Commercial Outdoor Lighting

COINCIDENCE FACTOR

The summer peak coincidence factor for this measure is assumed to be 0 for standard usage or 1.0 for 8766 hour lighting.¹³⁵⁰

Algorithm

CALCULATION OF ENERGY SAVINGS

ELECTRIC ENERGY SAVINGS

For remaining useful life (1st 3 years for standard operation and 1.5 year for 8760 operation) of existing equipment:

$$(1) \quad \Delta kWh = (W_{exist} - W_{eff}) * HOURS / 1000$$

For remaining life of measure (next 17 years for standard operation and 8.5 years for 8760 operation) or time of sale:

$$(2) \quad \Delta kWh = (W_{base} - W_{eff}) * HOURS / 1000$$

Where:

- W_{exist} =the connected load of the existing equipment
= actual existing equipment wattage
- W_{base} =the connected load of the baseline equipment
= assume appropriate High Pressure Sodium lamp wattage for application, see mapping table in ‘Definition of Baseline Equipment section above’
- W_{eff} =the connected load of the efficient equipment
= actual efficient equipment wattage
- EFLH = annual operating hours of the lamp
= 4,303 hours for standard operation¹³⁵¹
= 8,766 hours for always on lighting
- 1000 = conversion factor (W/kW)

Mid Life Baseline Adjustment

¹³⁴⁹ High Pressure Sodium replacement cost (lamp and labor) was provided by ComEd based on their composite maintenance rate.

¹³⁵⁰ Assuming standard operation of streetlight occurs outside the summer peak period of 1-5 PM. Coincidence Factor is assumed to equal 0.

¹³⁵¹ Based on Navigant verified value using 2014 Astronomical Applications Department, U.S. Naval Observatory data for ComEd’s service territory. See Navigant Memorandum ‘RE: LED Street Lighting Program Hours of Use for the ComEd and DCEO Programs. June 21, 2017’.

To calculate the mid life adjustment, divide the savings for remaining life of measure (1), by the first year savings (2) as provided above.

For example, an existing streetlight that uses a single 175 watt mercury vapor lamp is replaced by a 42W LED fixture. Accounting for ballast factor, the system load for the existing fixture is 205 watts. The HPS equivalent for the midlife adjustment is a 100 W lamp with total system load of 138 W. For a fixture with standard operating profile, the first year and lifetime savings for this installation are found as follows:

$$\begin{aligned} \Delta\text{kWh (first three years)} &= ((205 - 42) * 4,303) / 1000 \\ &= 701.4 \text{ kWh / year} \end{aligned}$$

$$\begin{aligned} \Delta\text{kWh (remaining seventeen years)} &= ((138 - 42) * 4,303) / 1000 \\ &= 413.2 \text{ kWh / year} \end{aligned}$$

Therefore, a midlife adjustment of 58.9% (413.2/701.4) would be applied after 3 years.

SUMMER COINCIDENT PEAK DEMAND SAVINGS

$$\Delta\text{kW} = (W_{\text{base}} - W_{\text{eff}}) / 1000 * \text{CF}$$

Where:

- CF = Summer Peak Coincidence Factor for measure
- = 0 for Standard operation
- = 1 for 8766 lighting

FOSSIL FUEL SAVINGS

N/A

WATER AND OTHER NON-ENERGY IMPACT DESCRIPTIONS AND CALCULATION

N/A

DEEMED O&M COST ADJUSTMENT CALCULATION

For EREP: to calculate an O&M adjustment, in addition to the deferred HPS replacement after 3 years, assume one additional HPS replacement lamp costing \$44 in year nine and year fifteen for standard operation or every 2.7 years for 8,766 hour lighting.¹³⁵²

For TOS: Assume one additional HPS replacement costing \$44 every 6 years for standard operation or every 2.7 years for 8,766 hour lighting.

MEASURE CODE: CI-LTG-STRT-V04-250101

REVIEW DEADLINE: 1/1/2030

¹³⁵² Assumes a rated life of the High Pressure Sodium lamp of 24,000 hours. High Pressure Sodium replacement cost (lamp and labor) was provided by ComEd based on their composite maintenance rate.

4.5.17 Exterior Photocell Repair

DESCRIPTION

This measure characterizes the repair of a photocell on an existing exterior light. A photocell is designed to switch exterior lights off during daylight hours, but if broken the fixtures may remain on 8760 hours.

This measure was developed to be applicable to the following program types: RF. If applied to other program types, the measure savings should be verified.

DEFINITION OF EFFICIENT EQUIPMENT

The efficient condition is an exterior light with a repaired or replaced photocell. The specifications and location of exterior lighting fixtures must be verified.

DEFINITION OF BASELINE EQUIPMENT

The baseline condition is an exterior light with a broken photocell.

DEEMED LIFETIME OF EFFICIENT EQUIPMENT

The assumed measure life is 2 years.¹³⁵³

DEEMED MEASURE COST

The deemed measure cost is \$65.52 per lighting sensor.¹³⁵⁴

LOADSHAPE

Loadshape C19 - Industrial Outdoor Lighting
Loadshape C20 - Commercial Outdoor Lighting

COINCIDENCE FACTOR

The summer peak coincidence factor for this measure is assumed to be 1.0. The savings for this measure will be throughout the daytime hours.

Algorithm

CALCULATION OF ENERGY SAVINGS

ELECTRIC ENERGY SAVINGS

$$\Delta kWh = (\text{Watts}_{\text{fixture}}/1000) * (\text{HOU}_{\text{PRE}} - \text{HOU}_{\text{POST}})$$

Where:

- $\text{Watts}_{\text{fixture}}$ = Input wattage of exterior lighting fixture(s) controlled by photocell
- HOU_{PRE} = Fixture Annual Operating Hours before Photocell repair/replacement
= 8,766 hours¹³⁵⁵
- HOU_{POST} = Fixture Annual Operating Hours with Photocell repaired / replaced

¹³⁵³ Estimated remaining life of an exterior lamp running 8760 hours.

¹³⁵⁴ Wisconsin Focus on Energy TRM 2017 based on historical project data cost of 643 units over 31 projects from 2014 to 2018.

¹³⁵⁵ Exterior lighting with broken photocells are typically identified by visual inspection during the daytime and it is assumed that exterior lighting that is found to be on during daylight hours is on during *all* day and night hours.

= 4,303 hours¹³⁵⁶

SUMMER COINCIDENT PEAK DEMAND SAVINGS

$$\Delta kW = \Delta kWh / (HOU_{PRE} - HOU_{POST}) * CF$$

Where:

CF = Summer Peak Coincidence Factor for measure
= 1¹³⁵⁷

FOSSIL FUEL SAVINGS

N/A

WATER AND OTHER NON-ENERGY IMPACT DESCRIPTIONS AND CALCULATION

N/A

DEEMED O&M COST ADJUSTMENT CALCULATION

N/A

MEASURE CODE: CI-LTG-PHRP-V01-210101

REVIEW DEADLINE: 1/1/2025

¹³⁵⁶ Assumption for Dusk to Dawn as provided in Section 4.5.

¹³⁵⁷ The savings for this measure will be throughout the daytime hours when the repaired photocell turns lighting off.

4.5.18 Ultra-Efficient LED Lighting

DESCRIPTION

This characterization provides savings assumptions for variety of ultra-efficient LED screw-based lamps including Omnidirectional (e.g., A-Type lamps), Decorative (e.g., Globes and Torpedoes) and Directional (PAR Lamps, Reflectors, MR16).

If the implementation strategy does not allow for the installation location to be known, for Residential targeted programs (e.g., an upstream retail program), a deemed split of 97% Residential and 3% Commercial assumptions should be used,¹³⁵⁸ and for Commercial targeted programs a deemed split of 97% Commercial and 3% Residential for non-linear LED Bulbs and 100% Commercial and 0% Residential for LED Fixtures and TLEDs should be used.¹³⁵⁹

Income Qualified Programs should not use this measure, but should continue to follow the dedicated guidance found in TRM section 4.5.4 through 2025.

This measure was developed to be applicable to the following program types: TOS. If applied to other program types, the measure savings should be verified.

DEFINITION OF EFFICIENT EQUIPMENT

In order for this characterization to apply, new lamps must exceed efficiency specifications defined in the “Standard-Efficiency LED Baseline Wattage” tables below. Consult the tables to find the *maximum* wattage that can be considered ultra-efficient for each bulb type.

Actual lamp wattages of the efficient equipment should be used to determine savings.

DEFINITION OF BASELINE EQUIPMENT

This TRM assumes that as of 6/30/2023, non-income qualified participants no longer have access to bulbs that do not meet the efficacy requirement defined by an EISA backstop provision. That provision effectively ensures that all lamps available in the market are at minimum an LED (no incandescent or compact fluorescent products). Therefore, lamp wattages that were historically considered efficient have now become the baseline to compare against emerging ultra-efficient options. See “Standard-Efficiency LED Baseline Wattage” tables below for specific baseline wattages by lamp type and lumen output.

DEEMED LIFETIME OF EFFICIENT EQUIPMENT

The lifetime for screw-based lamps is calculated as the rated lifetime of the product (actual if available, otherwise assume 20,000 hours for Omnidirectional, 17,000 hours for decorative and 25,000 for directional lamps based on average rated life of lamps on the ENERGY STAR Qualified Products list (accessed 6/16/2020)) divided by the reported operating hours, capped at 10 years.¹³⁶⁰

¹³⁵⁸ RES v C&I split is based on a weighted (by sales volume) average of ComEd PY8, PY9 and CY2018 and Ameren PY8 in store intercept survey results. See ‘RESvCI Split_2019.xlsx.’

¹³⁵⁹ Based on ComEd’s Instant Discounts program CY2018, CY2019 and CY2020 (Rounds 1 and 2) Purchaser Survey analysis. See ComEd Instant Discounts Enduser Survey TRM Updates.xlsx. For Residential installations, hours of use assumptions from ‘5.5.6 LED Downlights’ should be used for LED fixtures and ‘5.5.8 LED Screw Based Omnidirectional Bulbs’ should be used for LED bulbs.

DEEMED MEASURE COST

The actual ultra-efficient LED lamp cost should be used. For incremental cost, assume a baseline cost according to the following table¹³⁶¹:

Bulb Type	Standard LED Baseline Cost
Omnidirectional	\$2.70
Directional	\$5.18
Decorative and Globe	\$3.40

LOADSHAPE

- Loadshape C06 - Commercial Indoor Lighting
- Loadshape C07 - Grocery/Conv. Store Indoor Lighting
- Loadshape C08 - Hospital Indoor Lighting
- Loadshape C09 - Office Indoor Lighting
- Loadshape C10 - Restaurant Indoor Lighting
- Loadshape C11 - Retail Indoor Lighting
- Loadshape C12 - Warehouse Indoor Lighting
- Loadshape C13 - K-12 School Indoor Lighting
- Loadshape C14 - Indust. 1-shift (8/5) (e.g., comp. air, lights)
- Loadshape C15 - Indust. 2-shift (16/5) (e.g., comp. air, lights)
- Loadshape C16 - Indust. 3-shift (24/5) (e.g., comp. air, lights)
- Loadshape C17 - Indust. 4-shift (24/7) (e.g., comp. air, lights)
- Loadshape C18 - Industrial Indoor Lighting
- Loadshape C19 - Industrial Outdoor Lighting
- Loadshape C20 - Commercial Outdoor Lighting
- Loadshape C60 – Non-Residential Agriculture Lighting – 6 Hours
- Loadshape C61 – Non-Residential Agriculture Lighting – 8 Hours
- Loadshape C62 – Non-Residential Agriculture Lighting – 12 Hours
- Loadshape C63 – Non-Residential Dairy Long Day Lighting – 17 Hours
- Loadshape C64 – Non-Residential Agriculture Lighting – 24 Hours

COINCIDENCE FACTOR

The summer peak coincidence factor for this measure is dependent on the location type. Values are provided for each building type in the reference section below.

¹³⁶¹ Baseline and LED lamp costs are based on field data collected by CLEAResult and provided by ComEd. See ComEd Pricing Projections 06302016.xlsx for analysis. Given LED prices are expected to continue declining assumed costs should be reassessed on an annual basis and replaced with IL specific LED program information when available.

Algorithm

CALCULATION OF ENERGY SAVINGS

ELECTRIC ENERGY SAVINGS

$$\Delta kWh = ((Watts_{base} - Watts_{EE}) / 1000) * Hours * WHF_e * ISR$$

Where:

Watts_{EE} = Actual wattage of LED purchased / installed must be used.

Watts_{base} = Assumed wattage of standard efficiency LED baseline bulb. Reference the appropriate “Standard-Efficiency LED Baseline Wattage” table below.

Standard-Efficiency LED Baseline Wattage: Omnidirectional Lamps

Minimum Lumens	Maximum Lumens	Standard LED Baseline Wattage (WattsBase)
120	399	4.0
400	749	6.6
750	899	9.6
900	1,399	13.1
1,400	1,999	16.0
2,000	2,999	21.8
3,000	3,299	28.9

Standard-Efficiency LED Baseline Wattage: Decorative Lamps

Bulb Type	Minimum Lumens	Maximum Lumens	Standard LED Baseline Wattage (WattsBase)
Omni-Directional 3-Way	1,100	1,999	14.7
	2,000	2,700	22.6
Globe (medium and intermediate bases less than 750 lumens)	310	349	3.0
	350	499	4.7
	500	574	5.7
	575	649	6.5
	650	1,000	8.2
Globe (candelabra bases less than 1050 lumens)	310	349	3.5
	350	499	4.4
	500	574	5.5
Decorative (Shapes B, BA, C, CA, DC, F, G, medium and intermediate bases less than 750 lumens)	310	499	4.3
	500	800	5.8

Bulb Type	Minimum Lumens	Maximum Lumens	Standard LED Baseline Wattage (Watts _{Base})
Decorative (Shapes B, BA, C, CA, DC, F, G, T candelabra bases less than 1050 lumens)	310	499	4.2
	500	650	5.5
Decorative (Shape ST)	310	499	6.5
	500	999	8.8
	1000	1500	10.0
Decorative (Shape S)	310	340	2.25

Standard-Efficiency LED Baseline Wattage: Directional Lamps

Bulb Type	Minimum Lumens	Maximum Lumens	Standard LED Baseline Wattage (Watts _{Base})
Reflector lamp types with medium screw bases (PAR20, PAR30(S,L), PAR38, R40, etc.) w/ diameter >2.25"	400	649	7.0
	650	899	10.7
	900	1,049	13.9
	1,050	1,199	13.8
	1,200	1,499	15.9
	1,500	1,999	18.9
	2,000	3,299	27.3
Reflector lamp types with medium screw bases (PAR16, R14, R16, etc.) w/ diameter <2.25"	310	374	4.6
	375	600	6.4
BR30, BR40, or ER40	650	949	9.3
	950	1,099	12.7
	1,100	1,399	14.4
	1,400	1,600	16.6
	1,601	1,800	22.2
R20	450	524	6.0
	525	750	7.1
MR16	310	324	3.8
	325	369	4.8
	370	400	4.9

Standard-Efficiency LED Baseline Wattage Table: Additional EISA non-exempt bulb types

Bulb Type	Minimum Lumens	Maximum Lumens	Standard LED Baseline Wattage (Watts _{Base})
Dimmable Twist, Globe (less than 5" in diameter and > 749 lumens), candle (shapes B, BA, CA > 749 lumens), Candelabra Base Lamps (>1049 lumens), Intermediate Base Lamps (>749 lumens)	310	399	4.0
	400	749	6.6
	750	899	9.6
	900	1,399	13.1
	1,400	1,999	16.0

Hours = Average hours of use per year are provided in the Reference Table in Section 4.5 for each building type. If unknown, use the Miscellaneous value.

WHFe = Waste heat factor for energy to account for cooling energy savings from efficient lighting are provided below for each building type in the Reference Table in Section 4.5. If unknown, use the Miscellaneous value.

ISR = In Service Rate -the percentage of units rebated that actually get installed.
 =100% if application form completed with sign off that equipment is not placed into storage.¹³⁶² If sign off form not completed, assume the following ISR assumptions, if program survey data is not available:

Type	1st year In Service Rate (ISR) ¹³⁶³
LED Bulbs	97.9% ¹³⁶⁴
Efficiency Kits	92.9% ¹³⁶⁵

HEATING PENALTY

If electrically heated building:

$$\Delta kWh_{\text{heatpenalty}}^{1366} = (((\text{WattsBase}-\text{WattsEE})/1000) * \text{ISR} * \text{Hours} * -\text{IFkWh}$$

¹³⁶² Illinois evaluation of PY1 through PY3 has not found that fixtures or lamps placed into storage to be a significant enough issue to warrant including an "In-Service Rate" when commercial customers complete an application form.

¹³⁶³ In Service Rates now represent the lifetime In Service Rates with the second and third year installations discounted by the Real Discount Rate of 0.46%. Lifetime ISR assumptions for efficiency kits are based upon Residential direct mailed kits. For all other programs the 98% Lifetime ISR assumption is based upon the standard CFL measure in the absence of any better reference. This value is based upon review of two evaluations:

'Nexus Market Research, RLW Analytics and GDS Associates study; "New England Residential Lighting Markdown Impact Evaluation, January 20, 2009' and 'KEMA Inc, Feb 2010, Final Evaluation Report:, Upstream Lighting Program, Volume 1.' This implies that only 2% of bulbs purchased are never installed. The second and third year installations are based upon Ameren analysis of the Californian KEMA study showing that 54% of future installs occur in year 2 and 46% in year 3.

¹³⁶⁴ Based on ComEd's Instant Discounts program CY2019 and CY2020 (Rounds 1 and 2) Purchaser Survey analysis. See ComEd Instant Discounts Enduser Survey TRM Updates.xlsx

¹³⁶⁵ First year ISR is average ISR from CY2018, CY2019 and CY2020 ComEd Small Business Kit participant installation surveys. Please see file "SB Kits Survey Analysis TRMv10 Support.xlsx"

¹³⁶⁶Negative value because this is an increase in heating consumption due to the efficient lighting.

Where:

IFkWh = Lighting-HVAC Interaction Factor for electric heating impacts; this factor represents the increased electric space heating requirements due to the reduction of waste heat rejected by the efficient lighting. Values are provided in the Reference Table in Section 4.5. If unknown, use the Miscellaneous value.

SUMMER COINCIDENT PEAK DEMAND SAVINGS

$$\Delta kW = ((\text{Watts}_{\text{base}} - \text{Watts}_{\text{EE}}) / 1000) * \text{ISR} * \text{WHF}_d * \text{CF}$$

Where:

WHFd = Waste Heat Factor for Demand to account for cooling savings from efficient lighting in cooled buildings is provided in Reference Table in Section 4.5. If unknown, use the Miscellaneous value.

CF = Summer Peak Coincidence Factor for measure is provided in the Reference Table in Section 4.5. If unknown, use the Miscellaneous value.

FOSSIL FUEL SAVINGS

Heating Penalty if fossil fuel heated building (or if heating fuel is unknown):

$$\Delta \text{Therms} = ((\text{Watts}_{\text{Base}} - \text{Watts}_{\text{EE}}) / 1000) * \text{ISR} * \text{Hours} * \text{IFTherms}$$

Where:

IFTherms = Lighting-HVAC Integration Factor for gas heating impacts; this factor represents the increased gas space heating requirements due to the reduction of waste heat rejected by the efficient lighting. Values are provided in the Reference Table in Section 4.5. If unknown, use the Miscellaneous value.

WATER AND OTHER NON-ENERGY IMPACT DESCRIPTIONS AND CALCULATION

N/A

DEEMED O&M COST ADJUSTMENT CALCULATION

N/A

MEASURE CODE: CI-LTG-ULED-V01-240101

REVIEW DEADLINE: 1/1/2026

4.6.Refrigeration End Use

4.6.1 Automatic Door Closer for Walk-In Coolers and Freezers

DESCRIPTION

This measure is for installing an auto-closer to the main insulated opaque door(s) of a walk-in cooler or freezer. The auto-closer must firmly close the door when it is within 1 inch of full closure.

This measure was developed to be applicable to the following program types: RF.

If applied to other program types, the measure savings should be verified.

DEFINITION OF EFFICIENT EQUIPMENT

This measure consists of the installation of an automatic, hydraulic-type door closer on main walk-in cooler or freezer doors. These closers save energy by reducing the infiltration of warm outside air into the refrigeration itself.

DEFINITION OF BASELINE EQUIPMENT

In order for this characterization to apply, the baseline condition is assumed to be a walk in cooler or freezer without an automatic closure.

DEEMED LIFETIME OF EFFICIENT EQUIPMENT

The deemed measure life is 8 years.¹³⁶⁷

DEEMED MEASURE COST

The deemed incremental measure cost, which includes labor costs, is \$502 for a walk-in cooler or freezer.¹³⁶⁸

LOADSHAPE

Loadshape C22 - Commercial Refrigeration

COINCIDENCE FACTOR

The measure has deemed kW savings therefore a coincidence factor does not apply.

Algorithm

CALCULATION OF SAVINGS

ELECTRIC ENERGY SAVINGS

Savings calculations are based on values from through SCE Workpaper SWCR005 – Auto-Closers for Refrigerated Storage Door. Savings are averaged across all California climate zones and vintages.¹³⁶⁹

Annual Savings	kWh
Walk in Cooler	2,399
Walk in Freezer	6,949

SUMMER COINCIDENT PEAK DEMAND SAVINGS

Annual Savings	kW
Walk in Cooler	0.621
Walk in Freezer	1.300

¹³⁶⁷ Measure life estimate is sourced from California DEER Ex-Ante Support Table – 2020, Auto-Closer for Walk-In Cooler/Freezer Doors (GrocWlIn-DrClSr). For more detail, please see: "SupportTable_EUL2020.xlsx".

¹³⁶⁸ Commercial Refrigeration: Auto-Closer for Refrigerated Storage Door (SWCR005-02), California eTRM, November 16, 2020

¹³⁶⁹ Commercial Refrigeration: Auto-Closer for Refrigerated Storage Door (SWCR005-02), California eTRM, November 16, 2020. Energy savings are per cooler/freezer and represent an average of the modeled savings across all California climate zones.

FOSSIL FUEL SAVINGS

Natural gas savings are attributable to automatic door closers for refrigerated storage spaces. If the site is heated with natural gas as the primary fuel type, the following deemed fossil fuel savings can be claimed:¹³⁷⁰

Annual Savings	Therms
Walk in Cooler	0.183
Walk in Freezer	0.516

WATER IMPACT DESCRIPTIONS AND CALCULATION

N/A

DEEMED O&M COST ADJUSTMENT CALCULATION

N/A

MEASURE CODE: CI-RFG-ATDC-V03-230101

REVIEW DEADLINE: 1/1/2028

¹³⁷⁰ Commercial Refrigeration: Auto-Closer for Refrigerated Storage Door (SWCR005-02), California eTRM, November 16, 2020

4.6.2 Beverage and Snack Machine Controls

DESCRIPTION

This measure relates to the installation of new controls on refrigerated beverage vending machines, non-refrigerated snack vending machines, and glass front refrigerated coolers. Controls can significantly reduce the energy consumption of vending machine and refrigeration systems. Qualifying controls must power down these systems during periods of inactivity but, in the case of refrigerated machines, must always maintain a cool product that meets customer expectations. This measure relates to the installation of a new control on a new or existing unit. This measure should **not** be applied to ENERGY STAR qualified vending machines, as they already have built-in controls.

Vending machine categories are as defined¹³⁷¹ below:

- Refrigerated Beverage Vending Machine: A commercial refrigerator that cools bottled and/or canned beverages and dispenses the bottled and/or canned beverages on payment. Bottled or canned beverages means a beverage in a sealed container.
 - Class A Machine: A refrigerated bottled and/or canned beverage vending machine that is not a combination vending machine and in which 25 percent or more of the surface area on the front side of the beverage vending machine is transparent.
 - Class B Machine: Any refrigerated bottled and/or canned beverage vending machine not considered to be Class A, and is not a combination vending machine.
- Combination Vending Machine: A bottled and/or canned beverage vending machine containing two or more compartments separated by a solid partition, that may or may not share a product delivery chute, in which at least one compartment is designed to be refrigerated, as demonstrated by the presence of temperature controls, and at least one compartment is not.
 - Combination A: Combination vending machine where 25 percent or more of the surface area on the front side of the beverage vending machine is transparent.
 - Combination B: Combination vending machine that is not considered to be Combination A.

This measure was developed to be applicable to the following program types: RF.

If applied to other program types, the measure savings should be verified.

DEFINITION OF EFFICIENT EQUIPMENT

In order for this characterization to apply, the efficient equipment is assumed to be a standard efficiency refrigerated beverage vending machine, non-refrigerated snack vending machine, or glass front refrigerated cooler with a control system capable of powering down lighting and refrigeration systems during periods of inactivity.

DEFINITION OF BASELINE EQUIPMENT

In order for this characterization to apply, the baseline equipment is assumed to be a standard efficiency refrigerated beverage vending machine, non-refrigerated snack vending machine, or glass front refrigerated cooler without a control system capable of powering down lighting and refrigeration systems during periods of inactivity

DEEMED LIFETIME OF EFFICIENT EQUIPMENT

The expected measure life is assumed to be 5 years.¹³⁷²

DEEMED MEASURE COST

The actual measure installation cost should be used (including material and labor), but the following control costs¹³⁷³ can be assumed for analysis purposes:

¹³⁷¹ Code of Federal Regulations at 10 CFR 431. Subpart Q §431.296.

¹³⁷² Measure Life Study, prepared for the Massachusetts Joint Utilities, Energy & Resource Solutions, November 2005.

¹³⁷³ Measure Data and Specifications for the "Vending and Beverage Merchandise Controller", from the California eTRM, last updated 12/27/2018. Measure cost + Labor cost. The refrigerated machine was an average of several types (Double, single and triple doors). Please see file: SWAP011-01 MeasureDataSpec - Vending and Beverage Merchandise Controller r0.6.xlsm

Refrigerated Vending Machine and Glass Front Cooler: \$245

Non-Refrigerated Vending Machine: \$233

LOADSHAPE

Loadshape C52 - Beverage and Snack Machine Controls

COINCIDENCE FACTOR

The summer peak coincidence factor for this measure is assumed to be 0.¹³⁷⁴

Algorithm

CALCULATION OF SAVINGS

ELECTRIC ENERGY SAVINGS

$$\Delta kWh = \Delta kWh_{\text{Lighting}} + \Delta kWh_{\text{Ref BMC}}$$

$$\Delta kWh_{\text{Lighting}} = \frac{((8760 - \text{OccHours}) * W_{\text{Bulb}})}{1000}$$

$$\Delta kWh_{\text{Ref BMC}} = \text{MDEC} * (\text{SleepHours} / 24) * \text{Days}$$

Where:

OccHours = Average Annual Hours facility is occupied¹³⁷⁵
 = Actual, if unknown¹³⁷⁶ assume 3,379 hrs

W_{Bulb} = Wattage of bulb in Refrigerated Beverage Vending Machine.
 = Actual. If unknown use 56.4 W¹³⁷⁷ for fluorescent T8 bulbs¹³⁷⁸ and 31.6 W¹³⁷⁹ for TLEDs.

MDEC = Maximum Daily Energy Consumption per Federal regulations¹³⁸⁰. Refrigerated Volume of 21 (ft³) used in the calculations¹³⁸¹. If unknown, assume Class B, post-2019¹³⁸²:

Class	Vintage	EQN	MDEC (kWh/d)
A	post-2019	0.052 * V + 2.43	3.52
B		0.052 * V + 2.20	3.29
Combination A		0.086 * V + 2.66	4.47
Combination B		0.111 * V + 2.04	4.37

¹³⁷⁴ Assumed that the peak period is coincident with periods of high traffic diminishing the demand reduction potential of occupancy based controls.

¹³⁷⁵ Occupied hours of Use per IL TRM Section 4.5 Lighting, Fixture Annual Operating Hours.

¹³⁷⁶ If location is known, but hours are unknown, see IL TRM Section 4.5 Lighting, for list of various locations and Annual Hours.

¹³⁷⁷ See 3.4.5 LED Fixtures for the F32T8 Standard Lamp - 4 foot x 2 bulbs.

¹³⁷⁸ Per Houghton, D. 1996. "Refrigerated Vending Machines - Overlooked Devices Hold Opportunities for Efficiency, New Services." E Source Tech Update, TU-96-7, the typical backlit display for a refrigerated beverage vending machine consists of two five-foot linear fluorescent lamps." (PGE, SWAP011-01 Vending and Beverage Merchandise Controller measure, MeasureDataSpec file)

¹³⁷⁹ See 3.4.5 LED Fixtures for the TLED Lamp x 2 bulbs.

¹³⁸⁰ 10 CFR 431. Subpart Q §431.296 (a) & (b). <https://www.ecfr.gov/current/title-10/section-431.296>

¹³⁸¹ U.S. Department of Energy (DOE), Office of Energy Efficiency and Renewable Energy, Federal Energy Management Program. (n.d.) "Purchasing Energy-Efficient Refrigerated Beverage Vending Machines." Updated January 2020.

¹³⁸² Those standards are the most stringent and therefore savings would be conservative.

A	pre-2019	$0.055 * V + 2.56$	3.72
B		$0.073 * V + 3.16$	4.69

SleepHours = Maximum hours of sleep mode per day.
 = 4 hrs¹³⁸³

Days = Operating Days/yr.
 = 365

For example, adding controls to a Class B post-2019 Vintage refrigerated beverage vending machine in an unknown location:

$$\begin{aligned} \Delta kWh &= \Delta kWh_{\text{lighting}} + \Delta kWh_{\text{Ref BMC}} \\ \Delta kWh_{\text{lighting}} &= (8760 - \text{OccHours}) * W_{\text{Bulb}} \\ &= ((8760 - 3,379) * 72 \text{ W}) / 1,000 \\ &= 387 \text{ kWh/yr} \\ \Delta kWh_{\text{Ref BMC}} &= \text{MDEC} * \text{SleepHours}/24 * \text{Days} \\ &= 3.29 * 4/24 * 365 \\ &= 200 \text{ kWh/yr} \\ \Delta kWh &= 587 \text{ kWh/yr} \end{aligned}$$

SUMMER COINCIDENT PEAK DEMAND SAVINGS

N/A

FOSSIL FUEL SAVINGS

N/A

WATER IMPACT DESCRIPTIONS AND CALCULATION

N/A

DEEMED O&M COST ADJUSTMENT CALCULATION

N/A

MEASURE CODE: CI-RFG-BEVM-V04-250101

REVIEW DEADLINE: 1/1/2029

¹³⁸³ Itron, Inc. 2005. 2004-2005 Database for Energy Efficiency Resources (DEER) Update Study - Final Report. Prepared for the California Public Utilities Commission. Pg 3-22.

4.6.3 Door Heater Controls for Cooler or Freezer

DESCRIPTION

By installing a control device to turn off door heaters when there is little or no risk of condensation, one can realize significant energy savings. There are two commercially available control strategies that achieve “on-off” control of door heaters based on either (1) the relative humidity of the air in the store, or (2) the “conductivity” of the door (which drops when condensation appears). In the first strategy, the system activates your door heaters when the relative humidity in your store rises above a specific setpoint, and turns them off when the relative humidity falls below that setpoint. In the second strategy, the sensor activates the door heaters when the door conductivity falls below a certain setpoint, and turns them off when the conductivity rises above that setpoint.

This measure was developed to be applicable to the following program types: RF.

If applied to other program types, the measure savings should be verified.

DEFINITION OF EFFICIENT EQUIPMENT

In order for this characterization to apply, the efficient equipment is assumed to be a door heater control on a commercial glass door cooler or refrigerator utilizing humidity or conductivity control.

DEFINITION OF BASELINE EQUIPMENT

In order for this characterization to apply, the baseline condition is assumed to be a commercial glass door cooler or refrigerator with a standard heated door with no controls installed.

DEEMED LIFETIME OF EFFICIENT EQUIPMENT

The expected measure life is assumed to be 10 years.¹³⁸⁴

DEEMED MEASURE COST

The incremental capital cost, including labor costs, for a refrigeration door heater control, regardless of the control strategy, on a per door basis is \$79.50 per cooler door and \$90.77 per freezer door.¹³⁸⁵

LOADSHAPE

Loadshape C51 - Door Heater Control

COINCIDENCE FACTOR¹³⁸⁶

The summer peak coincidence factor for this measure is assumed to be 44%.¹³⁸⁷

Algorithm

CALCULATION OF SAVINGS

ELECTRIC ENERGY SAVINGS

$$\Delta \text{kWH} = \text{kWbase} * \text{NUMdoors} * \text{ESF} * \text{BF} * 8766$$

Where:

¹³⁸⁴ As recommended in Navigant ‘ComEd Effective Useful Life Research Report’, May 2018.

¹³⁸⁵ Door heater control unit costs are based on historical cost data, specific to the state of Illinois, collected by Ameren. See reference “Door Heater Costs AIC.xlsx” for more detail.

¹³⁸⁶ Source partial list from DEER 2008.

¹³⁸⁷ The summer peak coincidence factor is sourced from; Cadmus, “Commercial Refrigeration Loadshape Project Final Report”, Northeast Energy Efficiency Partnership, Regional Evaluation, Measurement, and Verification Forum, Lexington, MA, 2015 (table 39). The coincidence factor is based on the run-time profile of anti-sweat door heater controls, for all control types, for summer peak hours, and represents an average of the monitored reduced run time between heaters with and without controls.

- kWbase = connected load kW for typical reach-in refrigerator or freezer door and frame with a heater.
= If actual kWbase is unknown, assume 0.230 kW for freezers and 0.066 kW for coolers.¹³⁸⁸
- NUMdoors = number of reach-in refrigerator or freezer doors controlled by sensor
= Actual installed
- ESF = Energy Savings Factor; represents the percentage of hours annually that the door heater is powered off due to the controls.
= 45% for all control types ¹³⁸⁹
- BF = Bonus Factor; represents the increased savings due to reduction in cooling load inside the cases, and the increase in cooling load in the building space to cool the additional heat generated by the door heaters. ¹³⁹⁰

Definition	Representative Evaporator Temperature Range, °F ¹³⁹¹	Typical Uses	BF
Low	-35 to 0	Freezers for times such as frozen pizza, ice cream, etc.	1.50
Medium	0 – 20	Coolers for items such as meat, milk, dairy, etc	1.30
High	20 – 45	Coolers for items such as floral, produce and meat preparation rooms	1.30

8766 = annual hours of operation

SUMMER COINCIDENT PEAK DEMAND SAVINGS

$$\Delta kW = (\Delta kWh / 8766) * CF$$

Where:

CF = Summer Coincident Factor for the measure
= 0.44¹³⁹²

FOSSIL FUEL SAVINGS

N/A

¹³⁸⁸ Wattages per door derived from NEEP Refrigeration Loadshape Report. The Cadmus Group, Commercial Refrigeration Loadshape Project Final Report, Northeast Energy Efficiency Partnerships, Regional Evaluation, Measurement, and Verification Forum, Lexington, MA 2015 (pg. 57). For more detail, see reference file: IL TRM_Door Heater Control_Analysis_Jun 2021.xlsx

¹³⁸⁹ Difference in effective runtime of an uncontrolled heater and all control style heater controls. Anti-sweat door heater control reduced run time. The Cadmus Group, Commercial Refrigeration Loadshape Project Final Report, Northeast Energy Efficiency Partnerships, Regional Evaluation, Measurement, and Verification Forum, Lexington, MA 2015. Page 69, Section 4.1.4, Table 37.

¹³⁹⁰ Cooler and freezer bonus factors are from NEEP Refrigeration Loadshape Report. The Cadmus Group, Commercial Refrigeration Loadshape Project Final Report, Northeast Energy Efficiency Partnerships, Regional Evaluation, Measurement, and Verification Forum, Lexington, MA 2015 (pg. 78)

¹³⁹¹ Energy Efficiency Supermarket Refrigeration, Wisconsin Electric Power Company, July 23, 1993.

¹³⁹² The summer peak coincidence factor is sourced from; Cadmus, “Commercial Refrigeration Loadshape Project Final Report”, Northeast Energy Efficiency Partnership, Regional Evaluation, Measurement, and Verification Forum, Lexington, MA, 2015 (table 39). The coincidence factor is based on the run-time profile of anti-sweat door heater controls, for all control types, for summer peak hours, and represents an average of the monitored reduced run time between heaters with and without controls.

WATER IMPACT DESCRIPTIONS AND CALCULATION

N/A

DEEMED O&M COST ADJUSTMENT CALCULATION

N/A

MEASURE CODE: CI-RFG-DHCT-V04-220101

REVIEW DEADLINE: 1/1/2027

4.6.4 Electronically Commutated Motors (ECM) for Walk-in and Reach-in Coolers / Freezers

DESCRIPTION

This measure is applicable to the replacement of an existing, uncontrolled, and continuously operating standard-efficiency shaded-pole evaporator fan motor in refrigerated display cases or fan coil in walk-ins.

This measure achieves savings by installing a more efficient motor, the result of which produces less waste heat than the cooling system must reject.

If applicable, savings from this measure may be claimed in combination with measure 4.6.6 Evaporator Fan Control for Electronically Commutated Motors.

This measure was developed to be applicable to the following program types: RF.

If applied to other program types, the measure savings should be verified.

DEFINITION OF EFFICIENT EQUIPMENT

This measure applies to the replacement of an existing standard-efficiency shaded-pole evaporator fan motor in refrigerated display cases or fan coil in walk-ins. The replacement unit must be an electronically commutated motor (ECM) with a minimum efficiency of 66%. If controls are added as part of the motor upgrade to reduce annual run time, additional savings may potentially be claimed using measure 4.6.6 Evaporator Fan Control.

DEFINITION OF BASELINE EQUIPMENT

The baseline is the existing shaded-pole motor(s) with no fan control operating 8760 hours continuously in a refrigerated display case or fan coil unit of a walk-in cooling unit.

DEEMED LIFETIME OF EFFICIENT EQUIPMENT

The expected measure life is assumed to be 15 years.¹³⁹³

DEEMED MEASURE COST

The measure cost is assumed to be as follows, per motor, for a walk in cooler or walk in freezer:¹³⁹⁴

Walk-In Type	Equipment Cost (\$)	Labor \$/ECM Motor	Total \$ per motor
Cooler	\$358.50	\$63.80	\$422.30
Freezer	\$208.52	\$63.80	\$272.32
Unknown (average)	\$283.51	\$63.80	\$347.31

LOADSHAPE

Loadshape C53 - Flat

COINCIDENCE FACTOR

The peak kW coincidence factor is 100%.

¹³⁹³ DEER, Work Paper PGE3PREF126 ECM for Walk-In Evaporator with Fan Controller Revision # 2

¹³⁹⁴ CA eTRM "ECM Retrofit for a Walk-in Cooler or Freezer" measure, supporting Cost Data (file = swcr004-02_cost_analysis.xlsx).

Algorithm

CALCULATION OF SAVINGS

ELECTRIC ENERGY SAVINGS

$$\Delta kWh = \text{Savings per motor} * \text{motors}$$

Where:

Savings per motor = based on the motor rating of the ECM motor:

Evaporator Fan Motor Rating (of ECM)	Annual kWh Savings/motor
16W	652
1/15 - 1/20HP	1,586
1/5HP	2,320
1/3HP	3,380
1/2HP	4,481
3/4HP	5,293

= If unknown, assume 1/15 HP, therefore 1,586 kWh saved / motor¹³⁹⁵

motors = number of fan motors replaced

SUMMER COINCIDENT PEAK DEMAND SAVINGS

$$\Delta kW = \Delta kWh / \text{Hours} * CF * \text{motors}$$

Where:

ΔkWh = Gross customer annual kWh savings for the measure, as listed above
 = If unknown, assume 1,586 kWh¹³⁹⁶

Hours = Full Load hours per year
 = 8760

CF = Summer Peak Coincident Factor
 = 1.0

Other variables as defined above.

The following table provides the resulting kW savings (per motor), if unknown assume 0.181 kW saved / motor:¹³⁹⁷

Evaporator Fan Motor Rating (of ECM)	Peak kW Savings/motor
16W	0.074
1/15 - 1/20HP	0.181
1/5HP	0.265
1/3HP	0.386
1/2HP	0.512
3/4HP	0.604

¹³⁹⁵ Default motor size for EC Evaporator was found to be \leq 1/15 HP per the ComEd Standard Program data. See ECM Motor Size Supplement.xlsx.

¹³⁹⁶ Ibid.

¹³⁹⁷ Ibid.

FOSSIL FUEL SAVINGS

N/A

WATER IMPACT DESCRIPTIONS AND CALCULATION

N/A

DEEMED O&M COST ADJUSTMENT CALCULATION

N/A

MEASURE CODE: CI-RFG-ECMF-V05-250101

REVIEW DEADLINE: 1/1/2027

4.6.5 ENERGY STAR Refrigerated Beverage Vending Machine

DESCRIPTION

ENERGY STAR qualified new and rebuilt vending machines incorporate more efficient compressors, fan motors, and lighting systems as well as low power mode option that allows the machine to be placed in low-energy lighting and/or low-energy refrigeration states during times of inactivity.

This measure was developed to be applicable to the following program types: TOS, NC .

If applied to other program types, the measure savings should be verified.

DEFINITION OF EFFICIENT EQUIPMENT

The refrigerated vending machine can be new or rebuilt but must meet the ENERGY STAR specifications, as outlined below.¹³⁹⁸

A. Refrigerated Beverage Vending Machine: A commercial refrigerator that cools bottled and/or canned beverages and dispenses the bottled and/or canned beverages on payment. Bottled or canned beverages means a beverage in a sealed container.

a. Class A Machine: A refrigerated bottled and/or canned beverage vending machine that is not a combination vending machine and in which 25 percent or more of the surface area on the front side of the beverage vending machine is transparent.

b. Class B Machine: Any refrigerated bottled and/or canned beverage vending machine not considered to be Class A, and is not a combination vending machine

B. Combination Vending Machine: A bottled and/or canned beverage vending machine containing two or more compartments separated by a solid partition, that may or may not share a product delivery chute, in which at least one compartment is designed to be refrigerated, as demonstrated by the presence of temperature controls, and at least one compartment is not.

a. Combination A Machine: A combination vending machine where 25 percent or more of the surface area on the front side of the beverage vending machine is transparent.

b. Combination B Machine: A combination vending machine that is not considered to be Combination A.

DEFINITION OF BASELINE EQUIPMENT

The baseline vending machine is a standard unit.

DEEMED LIFETIME OF EFFICIENT EQUIPMENT

The deemed lifetime of this measure is 14 years.¹³⁹⁹

DEEMED MEASURE COST

The incremental cost of this measure is \$500.¹⁴⁰⁰.

LOADSHAPE

Loadshape C22 - Commercial Refrigeration

COINCIDENCE FACTOR

It is assumed that controls are only effective during off-peak hours and so have no peak-kW savings.

¹³⁹⁸ ENERGY STAR Program Requirements Specification for Refrigerated Beverage Vending Machines, Version 4.0

¹³⁹⁹ ENERGY STAR

¹⁴⁰⁰ ENERGY STAR

Algorithm

CALCULATION OF SAVINGS

ELECTRIC ENERGY SAVINGS

Using the ENERGY STAR MDEC Equations, as specified in the above paragraph and the Baseline Equipment DOE Standards,¹⁴⁰¹ the theoretical energy savings are calculated as:

$$\Delta kWh = (MDEC_{Baseline} - MDEC_{Efficient}) * Days$$

Where:

MDEC_{Baseline} = Maximum Daily Energy Consumption calculated using the equation from the table below, specific for the baseline equipment class and the volume range

MDEC_{Efficient} = Maximum Daily Energy Consumption calculated using the equation from the table below, specific for the ENERGY STAR Specification 4.0 equipment class and the volume range

Days = Days per year
= Actual. If unknown, assume 365.

Maximum Daily Energy Consumption (MDEC) equations for Baseline Equipment and ENERGY STAR equipment compliant with ENERGY STAR Specification V4.0 are outline in the table below:

Product Class	Refrigerated Volume Range (ft ³)	MDEC Equation (kWh/day) Federal Standard: Baseline	MDEC Equation (kWh/day) ENERGY STAR V4.0
Class A	11.5 - 38.5	0.052 * V + 2.43	0.04836 * V + 2.2599
Class B	21.8 - 30.5	0.052 * V + 2.20	0.04576 * V + 1.936
Combination A	9.7 - 16	0.086 * V + 2.66	0.07998 * V + 2.4738
Combination B	N/A	0.111 * V + 2.04	0.09768 * V + 1.7952

Where:

V = the refrigerated volume (ft³) of the refrigerated bottled or canned beverage vending machine, as specified in Appendix C.¹⁴⁰²

SUMMER COINCIDENT PEAK DEMAND SAVINGS

N/A

FOSSIL FUEL SAVINGS

N/A

WATER IMPACT DESCRIPTIONS AND CALCULATION

N/A

¹⁴⁰¹ CFR Title 10: Energy. PART 431—ENERGY EFFICIENCY PROGRAM FOR CERTAIN COMMERCIAL AND INDUSTRIAL EQUIPMENT. 10 CFR 431.296 (b), effective January 8, 2019. <https://www.ecfr.gov/current/title-10/section-431.296>

¹⁴⁰² Appendix C of the American National Standards Institute (ANSI)/ American Society of Heating, Refrigerating and Air-Conditioning Engineers (ASHRAE) Standard 32.1 - 2010, "Methods of Testing for Rating Vending Machines for Bottled, Canned or Other Sealed Beverages." For combination vending machines, the refrigerated volume does not include any non-refrigerated compartments.

DEEMED O&M COST ADJUSTMENT CALCULATION

N/A

MEASURE CODE: CI-RFG-ESVE- V05-250101

REVIEW DEADLINE: 1/1/2029

4.6.6 Evaporator Fan Control for Electrically Commutated Motors

DESCRIPTION

This measure is for the installation of controls for Electronically Commutated Motors in existing medium temperature walk-in coolers. The controller reduces airflow of the evaporator fans when there is no refrigerant flow.

This measure achieves savings by controlling the motor(s) to run at lower speeds (or shut off entirely) when there is no refrigerant flow, the result of which produces less waste heat that the cooling system must reject.

If eligible, this measure may be claimed in combination with 4.6.4 Electronically Commutated Motors (ECM) for Walk-in and Reach-in Coolers / Freezers.

This measure was developed to be applicable to the following program types: RF.

If applied to other program types, the measure savings should be verified.

DEFINITION OF EFFICIENT EQUIPMENT

The measure must control a minimum of 1/20 HP where fans operate continuously at full speed. The measure also must reduce fan motor power by at least 75% during the off cycle. This measure is not applicable if any of the following conditions apply:

- The compressor runs more than 4380 hours annually
- The evaporator fan does not run at full speed all the time
- The evaporator fan motor runs on poly-phase power
- Evaporator does not use off-cycle or time-off defrost.

DEFINITION OF BASELINE EQUIPMENT

In order for this characterization to apply, the existing condition must be a reach-in or walk-in freezer or cooler with continuously running evaporator fans driven by Electrically Commutated Motors

DEEMED LIFETIME OF EFFICIENT EQUIPMENT

The expected measure life is assumed to be 13 years.¹⁴⁰³

DEEMED MEASURE COST

The measure cost is assumed to be \$69.69 (controller equipment) plus \$92.06 (controller labor) = \$161.75 per motor controlled.¹⁴⁰⁴

LOADSHAPE

Loadshape C46 - Evaporator Fan Control

COINCIDENCE FACTOR

The measure has deemed kW savings therefore a coincidence factor does not apply.

Algorithm

CALCULATION OF SAVINGS

Savings are based on a measure created by Energy & Resource Solutions for the California Municipal Utilities Association¹⁴⁰⁵ and supported by a PGE workpaper. Note that climate differences across all California climate zones result in negligible savings differences, which indicates that the average savings for the California study should apply

¹⁴⁰³ As recommended in Navigant 'ComEd Effective Useful Life Research Report', May 2018.

¹⁴⁰⁴ Source: DEER, Work Paper PGE3PREF126 ECM for Walk-In Evaporator with Fan Controller Revision # 2

¹⁴⁰⁵ See reference Excel files in TRM Reference Documents folder for derivation of TRM values.

equally as well to Illinois. Savings found in the aforementioned source are presented in combination with savings from an ECM upgrade, however for the purposes of this measure only those associated with the controller are considered.

ELECTRIC ENERGY SAVINGS

$$\Delta kWh = \text{Savings per motor} * \text{motors}$$

Where:

Savings per motor = based on the motor rating of the ECM motor:

Evaporator Fan Motor Rating (of ECM)	Annual kWh Savings/motor
16W	198
1/15 - 1/20HP	293
1/5HP	856
1/3HP	1,419
1/2HP	2,126
3/4HP	3,209

motors = number of fan motors controlled

SUMMER COINCIDENT PEAK DEMAND SAVINGS

$$\Delta kW = \text{Peak kW savings per motor (as listed in the table below)} * \text{motors (as defined above)}$$

Evaporator Fan Motor Rating (of ECM)	Peak kW Savings/motor
16W	0.023
1/15 - 1/20HP	0.033
1/5HP	0.098
1/3HP	0.162
1/2HP	0.243
3/4HP	0.366

FOSSIL FUEL SAVINGS

N/A

WATER IMPACT DESCRIPTIONS AND CALCULATION

N/A

DEEMED O&M COST ADJUSTMENT CALCULATION

N/A

MEASURE CODE: CI-RFG-EVPP-V05-250101

REVIEW DEADLINE: 1/1/2029

4.6.7 Strip Curtain for Walk-in Coolers and Freezers

DESCRIPTION

This commercial measure pertains to the installation of infiltration barriers (strip curtains) on walk-in coolers or freezers. Strip curtains impede heat transfer from adjacent warm and humid spaces into walk-ins when the main door is opened, thereby reducing the cooling load. As a result, compressor run time and energy consumption are reduced. The engineering assumption is that the walk-in door is open for varying durations per day based on facility type, and the strip curtain covers the entire door frame. All algorithms and assumptions are based on prescriptive methodologies detailed by the Regional Technical Forum¹⁴⁰⁶, whose source calculations are outlined in ASHRAE's Refrigeration Handbook for calculating refrigeration load from infiltration by air exchange.

This measure was developed to be applicable to the following program types: RF.

If applied to other program types, the measure savings should be verified.

DEFINITION OF EFFICIENT EQUIPMENT

The efficient equipment is a strip curtain at least 0.06 inches thick added to a walk-in cooler or freezer.¹⁴⁰⁷ The new strip curtain must cover the entire area of the doorway when the door is opened.

DEFINITION OF BASELINE EQUIPMENT

The baseline assumption is a walk-in cooler or freezer that previously had either no strip curtain installed or an old, ineffective strip curtain installed.

DEEMED LIFETIME OF EFFICIENT EQUIPMENT

The expected measure life is assumed to be 4 years.¹⁴⁰⁸

DEEMED MEASURE COST

The incremental capital cost for this measure is \$10.22/sq ft of door opening.¹⁴⁰⁹

LOADSHAPE

Loadshape C22 - Commercial Refrigeration

COINCIDENCE FACTOR

The summer peak coincidence factor for this measure is 100%.¹⁴¹⁰

¹⁴⁰⁶ Database for UES Measures, Regional Technical Forum, Strip Curtains, version 2.1, September 2019

¹⁴⁰⁷ Pennsylvania Public Utility Commission Technical Reference Manual, Volume 3: Commercial and Industrial Measures, State of Pennsylvania Act 129 Energy Efficiency and Conservation Program & Act 213 Alternative Energy Portfolio Standards, Revised February 2021 -- Chapter 3.5.8 Strip Curtains for Walk-in Freezers and Coolers.

¹⁴⁰⁸ DEER 2014 Effective Useful Life.

¹⁴⁰⁹ The reference for incremental cost is \$10.22 per square foot of door opening (includes material and labor). 2008 Database for Energy-Efficiency Resources (DEER), Version 2008.2.05, "Cost Values and Summary Documentation", California Public Utilities Commission, December 16, 2008.

¹⁴¹⁰ The summer coincident peak demand reduction is assumed as the total annual savings divided by the total number of hours per year, effectively assuming the average demand reduction is realized during the peak period. This is a reasonable assumption for refrigeration savings.

Algorithm

CALCULATION OF SAVINGS

ELECTRIC ENERGY SAVINGS¹⁴¹¹

$$\Delta kWh = \Delta kWh/sq\ ft * A$$

Where:

$\Delta kWh/sq\ ft$ = Average annual kWh savings per square foot of infiltration barrier. Deemed values can be found in the table below

A = Doorway area in square feet.
 = Actual. If the actual doorway area in square feet is unknown, then use the values found in the table below

Default Energy Savings and Door Area for Strip Curtains¹⁴¹²

Type	Pre-Existing Curtains	Energy Savings $\Delta kWh/sq\ ft$	Doorway Area (sqft)
Supermarket - Cooler	Yes	40.9	21
Supermarket - Cooler	No	119.9	
Supermarket - Freezer	Yes	168.5	21
Supermarket - Freezer	No	494.3	
Convenience Store - Cooler	Yes	6.3	21
Convenience Store - Cooler	No	23.6	
Convenience Store - Freezer	Yes	10.0	21
Convenience Store - Freezer	No	33.2	
Restaurant - Cooler	Yes	6.2	21
Restaurant - Cooler	No	22.5	
Restaurant - Freezer	Yes	32.4	21
Restaurant - Freezer	No	114	
Refrigerated Warehouse	Yes	53.4	120
Refrigerated Warehouse	No	153.4	

SUMMER COINCIDENT PEAK DEMAND SAVINGS

$$\Delta kW = \Delta kWh / 8766 * CF$$

Where:

8766 = hours per year

¹⁴¹¹ The source algorithm from which the savings per square foot values are determined is based on Tamm’s equation (an application of Bernoulli’s equation) [Kaltverluste durch kuhlraumoffnungen. Tamm W, „Kaltetechnik-Klimatisierung 1966;18;142-144;] and the ASHRAE handbook [American Society of Heating, Refrigeration, and Air-Conditioning Engineers (ASHRAE). 2010. ASHRAE Handbook, Refrigeration: 13.4, 13.6].

¹⁴¹² Database for UES Measures, Regional Technical Forum, Strip Curtains, version 2.1, September 2019. Custom edits were made to the workbook in order for savings approach to align with this measure workpaper. The In-Service-Rate (described as the Removal Rate by the RTF workbook) was changed from 25% to 0%. Additionally, a 58% efficacy value was inputted for sites that had existing, but inefficient strip curtains prior to retrofit. This value is sourced from tracer gas measurements on over 100 walk-in refrigeration units during the California Public Utility Commission’s (CPUC) evaluation of the 2006-2008 CA investor owned utility energy efficiency programs. The baseline curtain efficacy rates are taken from short-term monitoring of over 100 walk-in units. “Commercial Facilities Contract Group 2006-2008 Direct Impact Evaluation”, CPUC, February 2010.

CF = Summer Peak Coincidence Factor for the measure
= 1.0

FOSSIL FUEL SAVINGS

N/A

WATER IMPACT DESCRIPTIONS AND CALCULATION

N/A

DEEMED O&M COST ADJUSTMENT CALCULATION

N/A

MEASURE CODE: CI-RFG-CRTN-V05-220101

REVIEW DEADLINE: 1/1/2027

4.6.8 Refrigeration Economizers

DESCRIPTION

This measure applies to commercial walk in refrigeration systems and includes two components, outside air economizers and evaporator fan controllers. Economizers save energy by bringing in outside air when weather conditions allow, rather than operating the compressor. Walk-in refrigeration systems evaporator fans run almost all the time; 24 hrs/day, 365 days/yr. This is because they must run constantly to provide cooling when the compressor is running, and to provide air circulation when the compressor is not running. However, evaporator fans are a very inefficient method of providing air circulation. Installing an evaporator fan control system will turn off evaporator fans while the compressor is not running, and instead turn on an energy-efficient 35 watt fan to provide air circulation, resulting in significant energy savings. This measure allows for economizer systems with evaporator fan controls plus a circulation fan and without a circulation fan.

This measure was developed to be applicable to the following program types: RF.

If applied to other program types, the measure savings should be verified. IECC code requires economizers in certain instances and therefore projects relying on code baseline definitions must verify eligibility.

DEFINITION OF EFFICIENT EQUIPMENT

To qualify for this measure an economizer is installed on a walk in refrigeration system.

DEFINITION OF BASELINE EQUIPMENT

The baseline condition is a walk-in refrigeration system without an economizer.

DEEMED LIFETIME OF EFFICIENT EQUIPMENT

The estimated life of this measure is 15 years.¹⁴¹³

DEEMED MEASURE COST

Installation costs can vary considerably depending on system size (larger systems may require multiple economizer units), physical site layouts (locating economizer intakes and ductwork), and controls elected. Therefore, actual site-specific costs should be used.

LOADSHAPE

Loadshape C22 - Commercial Refrigeration

COINCIDENCE FACTOR

The summer peak coincidence factor for this measure is assumed to be 0%.¹⁴¹⁴

Algorithm

CALCULATION OF ENERGY SAVINGS

ELECTRIC ENERGY SAVINGS

Electric energy savings is calculated dependent on whether evaporator fans controls are installed.

With Fan Control Installed

$$\Delta \text{kWh} = [\text{HP} * \text{kWhCond}] + [((\text{kWEvap} * \text{nFans}) - \text{kWCirc}) * \text{Hours} * \text{DCComp} * \text{BF}] - [\text{kWEcon} * \text{DCEcon} * \text{Hours}]$$

¹⁴¹³ Estimated life from DEER Work Paper PGE3PREF126.

¹⁴¹⁴ The economizer is only assumed to run when the outside temperature is below 33F (a 38°F cooler setpoint and 5 degree economizer deadband). Therefore savings will not coincide with the summer peak period.

Without Fan Control Installed

$$\Delta kWh = [HP * kWhCond] - [kWEcon * DCEcon * Hours]$$

Where:

HP = Horsepower of Compressor
= actual installed

kWhCond = Condensing unit savings, kWh/HP¹⁴¹⁵

Climate Zone (City based upon)	Hermetic / Semi-Hermetic	Scroll	Discus
1 (Rockford)	494	434	410
2 (Chicago/O’Hare)	423	372	352
3 (Springfield)	321	282	267
4 (Bellevue)	230	202	191
5 (Marion)	136	119	113

Hours = Number of annual hours that economizer operates ¹⁴¹⁶

Region (city)	Hours
1 (Rockford)	2,033
2 (Chicago/O’Hare)	1,806
3 (Springfield)	1,350
4 (Bellevue)	1,112
5 (Marion)	752

DCComp = Duty cycle of the compressor
= 50% ¹⁴¹⁷

kWEvap = Connected load kW of each evaporator fan
= If known, actual installed. Otherwise assume 0.126 kW¹⁴¹⁸

kWCirc = Connected load kW of the circulating fan
= If known, actual installed. Otherwise assume 0.035 kW¹⁴¹⁹

nFans = Number of evaporator fans
= actual number of evaporator fans

¹⁴¹⁵ Savings table uses Economizer Calc_Revised052024.xls. Assume 5HP compressor size used to develop kWh/Hp value. No floating head pressure controls and compressor is located outdoors. Bin Data for IL zones uses TMYx data.

¹⁴¹⁶ In the source TRM (VT) this value was 2,996 hrs based on 38° F cooler setpoint, Burlington VT weather data, and 5 degree economizer deadband. The IL numbers were calculated by using weather bin data for each location (number of hours < 38F at each location is the Hours value) from TMYx data.

¹⁴¹⁷ A 50% duty cycle is assumed based on examination of duty cycle assumptions from refrigeration suppliers (35%-65%), Cooltrol (35%-65%), Natural Cool (70%), Pacific Gas & Electric (58%). Also, manufacturers typically size equipment with a built-in 67% duty factor and contractors typically add another 25% safety factor, which results in a 50% overall duty factor.

¹⁴¹⁸ Based on a weighted average of 80% shaded pole motors at 175 watts and 20% PSC motors at 84 watts. Motor wattage and efficiency values referenced from Oak Ridge National Laboratory, “Permanent Magnet Synchronous Motors for Commercial Refrigeration: Final Report”, 2019. Table 1, page xiv; Table 24, page 57.

¹⁴¹⁹ Wattage of fan used by Freeaire and Cooltrol. This fan is used to circulate air in the cooler when the evaporator fan is turned off. As such, it is not used when fan control is not present.

- DCEcon = Duty cycle of the economizer fan on days that are cool enough for the economizer to be working
= If known, actual installed. Otherwise assume 63%¹⁴²⁰
- BF = Bonus factor for reduced cooling load from reduction of waste heat generation as a result of running the evaporator fan less
= 1.3¹⁴²¹
- kWEcon = Connected load kW of the economizer fan
= If known, actual installed. Otherwise assume 0.227 kW.¹⁴²²

For example, adding an outdoor air economizer and fan controls in Rockford to a 5 hp hermetic compressor walk in refrigeration unit with 3 evaporator fans would save:

$$\begin{aligned} \Delta\text{kWh} &= [\text{hp} * \text{kWhCond}] + [((\text{kWEvap} * \text{nFans}) - \text{kWCirc}) * \text{Hours} * \text{DCComp} * \text{BF}] - [\text{kWEcon} * \text{DCEcon} * \text{Hours}] \\ &= [5 * 494] + [(0.126 * 3) - 0.035] * 2033 * 0.5 * 1.3 - [0.227 * 0.63 * 2033] \\ &= 2633 \text{ kWh} \end{aligned}$$

SUMMER COINCIDENT PEAK DEMAND SAVINGS

$$\Delta\text{kW} = \Delta\text{kWh} / \text{Hours} * \text{CF}$$

Where:

- CF = Summer Peak Coincidence Factor for the measure
= 0¹⁴²³

FOSSIL FUEL SAVINGS

N/A

WATER IMPACT DESCRIPTIONS AND CALCULATION

N/A

DEEMED O&M COST ADJUSTMENT CALCULATION

N/A

MEASURE CODE: CI-RFG-ECON-V08-240101

REVIEW DEADLINE: 1/1/2028

¹⁴²⁰ Average of two manufacturer estimates of 50% and 75%.

¹⁴²¹ Bonus factor (1+ 1/3.5) assumes COP of 3.5, based on the average of standard reciprocating and discus compressor efficiencies with a Saturated Suction Temperature of 20°F and a condensing temperature of 90°F.

¹⁴²² The 227 watts for an economizer is calculated from the average of three manufacturers: Freeaire (186 Watts), Cooltrol (285 Watts), and Natural Cool (218 Watts).

¹⁴²³ The economizer is only assumed to run when the outside temperature is below 33F (a 38°F cooler setpoint and 5 degree economizer deadband). Therefore savings will not coincide with the summer peak period.

4.6.9 Night Covers for Open Refrigerated Display Cases

DESCRIPTION

This measure is the installation of fitted covers on existing open-type refrigerated and freezer display cases that are deployed during the facility unoccupied hours. Night covers are designed to reduce refrigeration energy consumption by reducing the work done by the compressor. Night covers reduce the heat and moisture entry into the refrigerated space through various heat transfer mechanisms. By fully or partially covering the case opening, night covers reduce the convective heat transfer into the case through reduced air infiltration. Additionally, they provide a measure of insulation, reducing conduction into the case, and also decrease radiation into the case by blocking radiated heat from entering the refrigerated space.

DEFINITION OF EFFICIENT EQUIPMENT

Curtains or covers on top of open refrigerated or freezer display cases that are applied at least six hours (during off-hours) in a 24-hour period.

DEFINITION OF BASELINE EQUIPMENT

Refrigerated and freezer, open-type display case in vertical, semi-vertical, and horizontal displays, with no night cover.

DEEMED LIFETIME OF EFFICIENT EQUIPMENT

The measure life is 5 years, based on DEER 2014.¹⁴²⁴

DEEMED MEASURE COST

The incremental capital cost for this measure is \$42 per linear foot of cover installed including material and labor.¹⁴²⁵

LOADSHAPE

Loadshape 22: Commercial Refrigeration

COINCIDENCE FACTOR

N/A – savings occur at night only.

Algorithm

CALCULATION OF ENERGY SAVINGS

ELECTRIC ENERGY SAVINGS

$$\Delta kWh = ES * L$$

Where:

ES = the energy savings (ΔkWh/ft) found in table below:

¹⁴²⁴ 2014 Database for Energy-Efficiency Resources (DEER), Version 2014, “Cost Values and Summary Documentation”, California Public Utilities Commission, January, 2014. Referenced in PG&E workpaper PGECOREF101 Night Covers for Display Cases, July 2014.

¹⁴²⁵ 2014 Database for Energy-Efficiency Resources (DEER), Version 2014, “Cost Values and Summary Documentation”, California Public Utilities Commission, January, 2014. Referenced in PG&E workpaper PGECOREF101 Night Covers for Display Cases, July 2014.

Display Case Description	Case Temperature Range (°F)	Annual Electricity Use kWh/ft ¹⁴²⁶	ES ΔkWh/ft reduction (= 9% reduction of electricity use ^{1427,1428,1429,1430})
Vertical Open, Remote Condensing, Medium Temperature	35°F to 55°F	1453	131
Vertical Open, Remote Condensing, Low Temperature	0°F to 30°F	3292	296
Vertical Open, Self-Contained Medium Temperature	35°F to 55°F	2800	252
Horizontal Open, Remote Condensing, Medium Temperature	35°F to 55°F	439	40
Horizontal Open, Remote Condensing, Low Temperature	0°F to 30°F	1007	91
Horizontal Open, Self-Contained, Medium Temperature	35°F to 55°F	1350	121
Horizontal Open, Self-Contained, Low Temperature	0°F to 30°F	2749	247

L = the length of the refrigerated case in linear feet
 = Actual

SUMMER COINCIDENT PEAK DEMAND SAVINGS

Peak savings are null because savings occur at night only.

FOSSIL FUEL SAVINGS

N/A

WATER IMPACT DESCRIPTIONS AND CALCULATION

N/A

DEEMED O&M COST ADJUSTMENT CALCULATION

N/A

¹⁴²⁶ Energy Conservation Standards for Commercial Refrigeration Equipment: Technical Support Document, U.S. Department of Energy, September 2013. The information required to estimate annual energy savings for refrigerated display cases is taken from the 2013-2014 U.S. Department of Energy (DOE) energy conservation standard rulemaking for Commercial Refrigerated Equipment. During the rulemaking process, DOE estimates the energy savings specific to night covers through extensive simulation and energy models that are validated by both manufacturers of night covers and refrigerated cases. The information is also referenced from a study done by Southern California Edison and testing by Technischer Überwachungs-Verein Rheinland, which are used by DOE for the rulemaking process.

¹⁴²⁷ Southern California Edison Refrigeration Technology and Test Center. Effects of the Low Emissivity Shields on Performance and Power Use of a Refrigerated Display Case. 1997. Southern California Edison, Rancho Cucamonga, CA.

¹⁴²⁸ ASHRAE, Effects of Low-E Shields on the Performance and Power Use of a Refrigerated Display Case. 1999

¹⁴²⁹ Connecticut Power & Light, Thermal Night Covers for Refrigerated Supermarket Display Cases. 2014

¹⁴³⁰ Technischer Überwachungs-Verein Rheinland E.V. Laboratory test results for energy savings on refrigerated dairy case, conducted for Econofrost.

MEASURE CODE: CI-RFG-NCOV-V02-240101

REVIEW DEADLINE: 1/1/2029

4.6.10 High Speed Rollup Doors

DESCRIPTION

This measure entails the installation of High Speed Doors in refrigerated warehouses. High speed doors can save energy by lowering infiltration through a reduction in time that cooled spaces are exposed to ambient outdoor conditions. This in turn can lower the demand on refrigeration systems.

This measure was developed to be applicable to the following program types: RF.

If applied to other program types, the measure savings should be verified.

DEFINITION OF EFFICIENT EQUIPMENT

To qualify for this measure the installed equipment must be a High Speed Door installed on the loading dock doorway of a refrigerated space. The high speed door is assumed to act as a primary door. It should be noted that for high-traffic applications (about 45 door passages per hour, using the defaults for this measure) a custom analysis is necessary to ensure that high-speed rollup doors will provide savings, because strip curtains may outperform the high speed door, if no other open-door protection device is installed.

DEFINITION OF BASELINE EQUIPMENT

The baseline equipment is existing strip curtains on doorways to a loading dock. During times of traffic, primary doors are left open, leaving just the strip curtains as open-doorway protection.

DEEMED LIFETIME OF EFFICIENT EQUIPMENT

The expected measure life is assumed to be 16 years.¹⁴³¹

DEEMED MEASURE COST

The incremental measure cost is \$150/sqft.¹⁴³²

LOADSHAPE

Loadshape C22 - Commercial Refrigeration

COINCIDENCE FACTOR

The coincidence factor is assumed to be 1.00.

Algorithm

CALCULATION OF SAVINGS

ELECTRIC ENERGY SAVINGS

Electric savings consider the change in loading on the refrigeration system as well as the consumption of the drive on the high speed door. The following algorithms are based heavily on those derived and described in chapter 24 Refrigerated-Facility Loads of the ASHRAE Refrigeration Handbook.

$$\Delta kWh = (0.00008333 * q * D_f * \eta * [D_{tB}(1 - E_B) - D_{tE}(1 - E_E)] - D_{tM}M) * t$$

Where:

0.00008333 = conversion from Btu/h to tons

q = sensible and latent refrigeration load for fully established flow, Btu/h

¹⁴³¹ As recommended in Navigant 'ComEd Effective Useful Life Research Report', May 2018.

¹⁴³² Rite Hite – Industrial High Speed Doors

$$= 3790 * W * H^{1.5} * \left(\frac{Q_s}{A}\right) * \left(\frac{1}{R_s}\right)$$

W = width of doorway, in feet. Custom input.

H = height of doorway, in feet. Custom input.

$\frac{Q_s}{A}$ = Sensible heat load of infiltration air per square foot of door way opening, as read from the following figure and dependent on infiltration air temperature and cooled space temperature. If unknown, infiltration temperature can be assumed to be 50° F,¹⁴³³ cooler temperature 35° F, and freezer temperature -10° F,¹⁴³⁴ resulting in values of 0.06 for a cooler and 0.5 for a freezer.

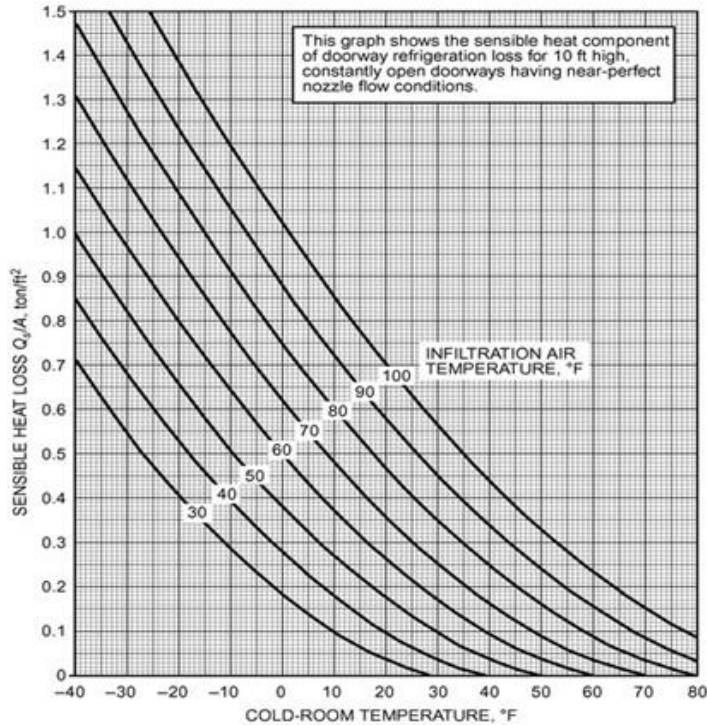

R_s = Sensible heat ratio of the infiltration air heat gain, as read or interpolated from the chart below or from a psychrometric chart, dependent on temperature and relative humidity of infiltration air and cooled space temperature. If unknown, use the same assumptions as previously, with a warm space relative humidity value of 70%,¹⁴³⁵ resulting in values of 0.685 (interpolated) for coolers and 0.73 (interpolated) for freezers.

¹⁴³³ Taken to represent the overall annual average temperature in Illinois. TMY3 data for the five weather regions defined by the TRM indicate averages that fall within the range of 47.6 (Rockford) to 55.9 (Marion).

¹⁴³⁴ Refrigerated Warehouse, 2013 California Building Energy Standards, CODES AND STANDARDS ENHANCEMENT INITIATIVE (CASE), March 2011,

¹⁴³⁵ Taken to represent the overall annual average in Illinois. TMY3 data for the five weather regions defined by the TRM indicate averages that fall within the range of 69.1 (Springfield) to 72.1 (Rockford).

Warm Space		Cold Space at 90% rh									
Temp.	rh	Dry-Bulb Temperature, °F									
°F	%	-40	-30	-20	-10	0	10	20	30	40	50
70	100	0.60	0.58	0.56	0.53	0.50	0.47	0.44	0.41	0.37	0.34
	80	0.66	0.64	0.61	0.59	0.56	0.53	0.50	0.48	0.46	0.44
	60	0.72	0.70	0.68	0.66	0.63	0.61	0.59	0.58	0.59	0.64
	40	0.79	0.78	0.76	0.75	0.73	0.72	0.71	0.73	0.80	—
60	100	0.66	0.64	0.62	0.59	0.56	0.52	0.49	0.45	0.41	0.35
	80	0.71	0.69	0.67	0.64	0.62	0.59	0.56	0.53	0.52	0.53
	60	0.77	0.75	0.73	0.71	0.69	0.67	0.65	0.65	0.70	—
	40	0.83	0.82	0.81	0.79	0.78	0.77	0.78	0.83	—	—
50	100	0.72	0.70	0.67	0.64	0.61	0.57	0.53	0.49	0.43	—
	80	0.76	0.74	0.72	0.70	0.67	0.64	0.61	0.59	0.62	—
	60	0.81	0.80	0.78	0.76	0.74	0.72	0.71	0.75	—	—
	40	0.87	0.86	0.84	0.83	0.82	0.82	0.85	—	—	—
40	100	0.77	0.75	0.72	0.69	0.66	0.62	0.57	0.51	—	—
	80	0.81	0.79	0.77	0.74	0.72	0.69	0.66	0.67	—	—
	60	0.85	0.84	0.82	0.80	0.78	0.77	0.79	0.99	—	—
	40	0.90	0.89	0.88	0.87	0.86	0.88	0.97	—	—	—
30	100	0.82	0.80	0.77	0.74	0.70	0.66	0.59	—	—	—
	80	0.85	0.83	0.81	0.79	0.76	0.73	0.73	—	—	—
	60	0.88	0.87	0.86	0.84	0.83	0.83	0.94	—	—	—
	40	0.92	0.91	0.90	0.90	0.91	0.96	—	—	—	—
20	100	0.86	0.84	0.82	0.79	0.75	0.69	—	—	—	—
	80	0.89	0.87	0.85	0.83	0.81	0.80	—	—	—	—
	60	0.91	0.90	0.89	0.88	0.88	0.95	—	—	—	—
	40	0.94	0.94	0.93	0.94	0.97	—	—	—	—	—
10	100	0.90	0.88	0.86	0.83	0.78	—	—	—	—	—
	80	0.92	0.90	0.89	0.87	0.86	—	—	—	—	—
	60	0.94	0.93	0.92	0.92	0.96	—	—	—	—	—
	40	0.96	0.96	0.96	0.98	—	—	—	—	—	—
0	100	0.92	0.91	0.89	0.85	—	—	—	—	—	—
	80	0.94	0.93	0.92	0.91	—	—	—	—	—	—
	60	0.96	0.95	0.95	0.97	—	—	—	—	—	—
	40	0.97	0.97	0.98	—	—	—	—	—	—	—

D_f = doorway flow factor. Equal to 0.8 for a doorway between a freezer and a dock and 1.1 for a doorway between a cooler and a dock.¹⁴³⁶

η = Efficiency of refrigeration system (kW/ton). Custom input, if unknown assume 1.6 kW/ton for coolers and 2.4 kW/ton for freezers.¹⁴³⁷

D_{tB} = decimal portion of time doorway is open in the baseline condition. If during facility operating hours, the primary doors are left open, leaving only open-doorway protective devices (e.g., strip curtains) as a barrier, this is considered 1.0. If primary doors are actively operated and do not remain open for the entire time the facility is in operation, refer to the following calculation.

$$D_{tB} = \frac{(P \theta_{pB} + 60 \theta_{oB})}{3600 \theta_d}$$

P = Number of passages through doorway per hour.

θ_{pB} = Door open to close time in seconds.

θ_{oB} = Time door remains open in minutes.

θ_d = Period of time considered in hours, 1 hr.

D_{tE} = decimal portion of time doorway is open in the efficient condition.

$$D_{tE} = \frac{(P \theta_{pE} + 60 \theta_{oE})}{3600 \theta_d}$$

¹⁴³⁶ ASHRAE, "Refrigerated –Facility Loads", in Refrigeration Handbook 2014: ASHRAE, 2014, 24.7.

¹⁴³⁷ Professional judgement, in alignment with typical freezer and cooler performance found in the Michigan Energy Measures Database (MEMD).

- P = Number of passages through doorway per hour. Custom input; assume 5.9 if unknown.¹⁴³⁸
- Θ_{pE} = Door open to close time in seconds. Custom input; assume 7.5 seconds if unknown.¹⁴³⁹
- Θ_{oE} = Time door remains open in minutes. Custom input; assume 3 minutes if unknown.¹⁴⁴⁰
- Θ_d = Period of time considered in hours, 1 hr.
- D_{tM} = decimal portion of time high speed door motor is operational.

$$D_{tM} = \frac{P \theta_{pE}}{3600 \theta_d}$$

Variables defined above.

- E_B = effectiveness of baseline open-doorway protective device (strip curtains). Equal to 0.85.¹⁴⁴¹
- E_E = effectiveness of efficient open-doorway protective device. Equal to 0, unless an additional protective device exists to limit infiltration during times when the high-speed door is open.
- M = operating input power of the high speed door motor, in kW.
= Custom input; assume 1.49kW if unknown.¹⁴⁴²
- t = hours per year when primary doors to the cooled space are open.
= Custom input; assume 2,959 hrs/yr if unknown.¹⁴⁴³

SUMMER COINCIDENT PEAK DEMAND SAVINGS

$$\Delta kW = (\Delta kWh / t) * CF$$

Where

- CF = Summer peak coincidence factor for this measure
= 1.0

All other variables as defined above.

FOSSIL FUEL SAVINGS

N/A

WATER IMPACT DESCRIPTIONS AND CALCULATION

N/A

DEEMED O&M COST ADJUSTMENT CALCULATION

Manufacturers suggest annual inspection and maintenance (such as patching tears) of high speed doors. At a minimum, greasing of fittings and oil top-off should be carried out annually. This is estimated at a cost of \$150 per year.¹⁴⁴⁴

¹⁴³⁸ ASHRAE, "Refrigerated –Facility Loads", in Refrigeration Handbook 2014: ASHRAE, 2014, 24.11

¹⁴³⁹ ASHRAE, "Refrigerated –Facility Loads", in Refrigeration Handbook 2014: ASHRAE, 2014, 24.6

¹⁴⁴⁰ Professional judgement.

¹⁴⁴¹ ASHRAE, "Refrigerated –Facility Loads", in Refrigeration Handbook 2014: ASHRAE, 2014, 24.7

¹⁴⁴² Rite Hite – Industrial High Speed Doors, product line commonly uses 2HP drives.

¹⁴⁴³ Based on a ComEd survey that obtained the number of hours per week certain building types operate. Warehouses had an average response of 55.6 and industrials had 58.2. Calculated by taking the simple average of the two and multiplying by 52 weeks/yr.

¹⁴⁴⁴ Assumes approximately 1 hour of maintenance, based on manufacturer product spec sheets.

MEASURE CODE: CI-RFG-HSRD-V03-220101

REVIEW DEADLINE: 1/1/2026

4.6.11 Q-Sync Motors for Walk-in and Reach-in Coolers/Freezers

DESCRIPTION

This measure is applicable to replacement of an existing, uncontrolled, and continuously operating standard-efficiency shaded-pole, permanent split capacitor (PSC), and electronically commutated (EC) evaporator fan motors in reach-in refrigerated display cases as well as walk-in coolers and freezers.

This measure achieves energy savings by installing a more efficient Q-Sync motor in these scenarios (accompanied with replacement fan assembly as necessary). In addition to motor energy savings, the measure also results in less waste heat for the refrigeration equipment to reject and improves the power factor of the equipment.

This measure is limited to a typical reach-in refrigerated display case with the evaporator fan power of 9-12 Watts and walk-in coolers and freezers with the evaporator fan power of 38-50 Watts. In addition to the motor, replacement of the evaporator fan is necessary to ensure matching airflow is provided (because the fan’s speed has been modified). Care must be taken by the installer to ensure airflows remain within the specified range, otherwise fan performance could suffer, causing reliability issues. Q-Sync motors are commonly purchased as a kit, which includes replacement fan blades and shrouds when replacement is necessary.

This measure was developed to be applicable to the following program types: RF, NC.¹⁴⁴⁵

If applied to other program types, the measure savings should be verified.

DEFINITION OF EFFICIENT EQUIPMENT

The replacement unit must be a 9-12 Watt Q-Sync motor with a minimum of 73% motor efficiency or a 38-50 Watt Q-Sync motor with a minimum of 81% motor efficiency (as listed by manufacturer).

DEFINITION OF BASELINE EQUIPMENT

Depending on existing conditions, one of three baselines is chosen:

Baseline 1: existing shaded-pole motor(s) with no fan control operating 8760 hours continuously in a refrigerated reach-in display case, walk-in cooler, or walk-in freezer.

Baseline 2: EC motor with no fan control operating 8760 hours continuously in a refrigerated reach-in display case.

Baseline 3: existing PSC motor(s) with no fan control operating 8760 hours continuously in a walk-in cooler or freezer.

Baseline 4: blended baseline, consisting of a mix of shaded-pole motors and EC motors that are assumed to be present in retrofit project where accurate counts are unknown or difficult to determine. It is assumed that existing motors have no fan control and operate 8760 hours continuously in refrigerated reach-in display cases.

DEEMED LIFETIME OF EFFICIENT EQUIPMENT

The deemed measure life is ten years.¹⁴⁴⁶

DEEMED MEASURE COST

Actual measure costs should be used if available. If costs are not available, the following deemed measure cost can be used.¹⁴⁴⁷

Measure	Material Unit (Each)	Material Cost / Unit	Labor Unit (Hours)	Labor Rate / Unit	Total Cost / Unit
9-12-watt Q-Sync motor (including replacement fan kit)	1	\$52	0.25	\$120	\$82

¹⁴⁴⁵ Customers should be encouraged to check with the manufacturer to determine any impact on warranty of new equipment due to installing Q-sync fan/motor assemblies.

¹⁴⁴⁶ Based on communication with QM Power representative, April 16, 2018. See reference document “4.16.2018 Email.msg”.

¹⁴⁴⁷ Based on communication with QM Power representative, April 24, 2018. See reference document “4.24.2018 Email.msg”.

Measure	Material Unit (Each)	Material Cost / Unit	Labor Unit (Hours)	Labor Rate / Unit	Total Cost / Unit
38-50-watt Q-Sync motor (including replacement fan kit)	1	\$50	0.50	\$120	\$110

Note: the material unit cost is based on a large-scale retrofit project.

LOADSHAPE

Loadshape C53 - Flat

COINCIDENCE FACTOR

The peak kW coincidence factor is 100%

Algorithm

CALCULATION OF ENERGY SAVINGS

To determine the savings associated with the Q-Sync motor measure we utilized the field study results provided by Oak Ridge National Laboratory (ORNL)¹⁴⁴⁸ and Alternative Energy Systems Consulting (AESC)¹⁴⁴⁹ for refrigerated display cases, and the field study results provided by Slipstream¹⁴⁵⁰ and ORNL¹⁴⁵¹ for walk-in coolers and freezers.

For refrigerated display cases, in 2015, ORNL conducted a side-by-side comparison of Q-Sync motors with EC motors in a 16 ft medium-temperature vertical multi-deck refrigerated display case at an Hy-Vee Supermarket in the Kansas City metropolitan area. A retrofit was done on the display case that contained four 12 W EC evaporator fan motors, two in each 8 ft section. Two existing EC motors in one of the 8 ft sections were replaced with two 12 W Q-Sync motors. The initial results show that Q-Sync motors consumed approximately 16.4 watts per motor, and EC motors consumed approximately 22.6 watts per motor.¹⁴⁵²

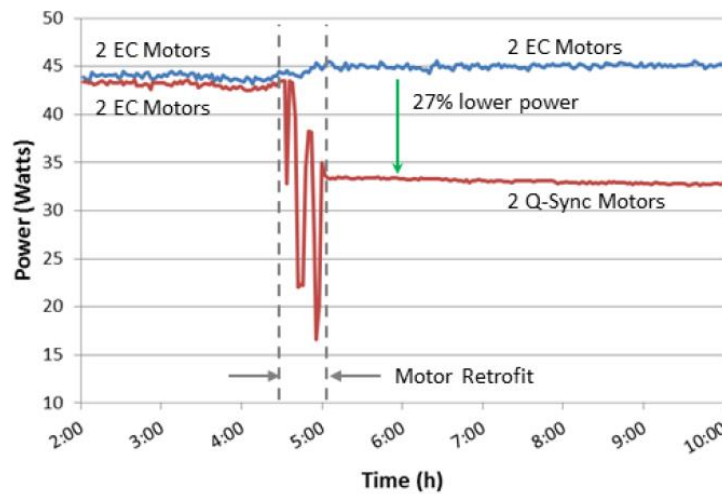

¹⁴⁴⁸ Brian A. Fricke and Bryan R. Becker, “Q-Sync Motors in Commercial Refrigeration: Preliminary Test Results and Projected Benefits,” Oak Ridge National Laboratory, September 2015.

¹⁴⁴⁹ M. Valmiki and Antonio Corradini, “Energy Savings of Permanent Magnet Synchronous Fan Motor Assembly Refrigerated Case Evaporators,” Alternative Energy Systems Consulting, August 2016.

¹⁴⁵⁰ Xiaohui Zhou, et al, “Q-Sync Motor Performance in Walk-in Coolers and Freezers: Field Test for ComEd Emerging Technologies,” Slipstream, March 2019.

¹⁴⁵¹ Brian A. Fricke and Bryan R. Becker, “Permanent Magnet Synchronous Motors for Commercial Refrigeration: Final Report,” Oak Ridge National Laboratory, July 2018.

¹⁴⁵² Brian A. Fricke and Bryan R. Becker, “Q-Sync Motors in Commercial Refrigeration: Preliminary Test Results and Projected Benefits,” Oak Ridge National Laboratory, September 2015.

In comparison, the 2011 study by Navigant and PNNL determined that a 12 w shade-pole motor’s actual power is 60.0 watts for use in commercial refrigeration equipment at design condition,¹⁴⁵³ even though some manufacturers also pointed out that “there could be significant variations in efficiency between motors of the same type but different models.” In the AESC study, the field test showed that the average input power for each of the 13 shaded pole motors retrofitted is 41.6 watts. As a compromise between the two studies, we use 50.0 watts as a representative number for shaded pole motors in our calculation. The average evaporator fan motor powers in refrigerated cases are summarized in the following table.

	Shaded-pole motor	PSC motor	Q-Sync motor
Average evaporator fan motor power in refrigerated display cases (watt)	50.0	22.6	16.4

For walk-in coolers and freezers, in 2019, Slipstream conducted a field study in three small businesses in Illinois retrofitting a total of 18 evaporator fan motors in 7 walk-in coolers or freezers. The average input power for each of the existing 16 shaded-pole motors was 131.6 watts, and 58.4 watts for each of the existing two PSC motors. The average input power for each of the 18 Q-Sync motors post-retrofit was 40.1 watts. In the ORNL 2018 field study on walk-in cooler/freezers in two supermarkets, the average input power for each of the existing 20 shaded-pole fan motors was 111.5 watts, and 61.4 watts for each of the existing 73 PSC motors. The average input power for each of the 93 Q-Sync motors post-retrofit was 36.6 watts. Combining both studies’ results, the average powers for evaporator fan motors pre- and post-retrofit are listed in the following table:

	Shaded-pole motor	PSC motor	Q-Sync motor
Average evaporator fan motor power in walk-in coolers/freezers (watt)	120.4	61.3	37.2

For refrigerated display cases:

The electrical energy savings for replacing a shaded-pole motor with a Q-Sync motor in a retrofit project is calculated by the difference of the two motors demonstrated power draw multiplied by the annual operating hours. For med-temperature cases, T is 8,760 hours. For low-temp freezer cases, T is 8,578 hours considering daily 30-minute defrost cycles during which fans are not powered.¹⁴⁵⁴

$$\begin{aligned} &\text{Motor energy savings (Baseline 1, med-temp, per motor)} \\ &= (50 \text{ W} - 16.4 \text{ W}) \times 8760 \text{ hours} / 1000 = 294.336 \text{ kWh} \end{aligned}$$

$$\begin{aligned} &\text{Motor energy savings (Baseline 1, low-temp, per motor)} \\ &= (50 \text{ W} - 16.4 \text{ W}) \times 8578 \text{ hours} / 1000 = 288.221 \text{ kWh} \end{aligned}$$

The electrical energy savings for replacing an EC motor with a Q-Sync motor in a retrofit project is calculated by the difference of the two motors demonstrated power draw multiplied by the annual operating hours (8760 hours):

$$\begin{aligned} &\text{Motor energy savings (Baseline 2, med-temp, per motor)} \\ &= (22.6 \text{ W} - 16.4 \text{ W}) \times 8760 \text{ hours} / 1000 = 54.312 \text{ kWh} \end{aligned}$$

$$\text{Motor energy savings (Baseline 2, low-temp, per motor)}$$

¹⁴⁵³ NCI (Navigant Consulting Inc.) and PNNL (Pacific Northwest National Laboratory), “Preliminary Technical Support Document (TSD): Energy Conservation Program for Certain Commercial and Industrial Equipment: Commercial Refrigeration Equipment,” Appliances and Commercial Equipment Standards, Building Technologies Program, Office of Energy Efficiency and Renewable Energy, US Department of Energy, Washington, D.C., 2011.

¹⁴⁵⁴ M M. Valmiki and Antonio Corradini, “Energy Savings of Permanent Magnet Synchronous Fan Motor Assembly Refrigerated Case Evaporators,” Alternative Energy Systems Consulting, August 2016.

$$= (22.6 \text{ W} - 16.4 \text{ W}) \times 8578 \text{ hours} / 1000 = 53.184 \text{ kWh}$$

The reduced motor power will also reduce refrigeration load. Assuming the power to drive the evaporator fan is converted to heat inside the display cases at 100% rate, the reduction in refrigeration system compressor power can be calculated using the following equation:

$$\Delta kWh_{refrigeration} = \frac{\Delta kWh_{motor}}{COP},$$

where COP is the Coefficient of Performance of refrigeration systems in the supermarket display cases. For med-temperature cases, the average COP is 2.5¹⁴⁵⁵. For low-temp freezer cases, the average COP is 1.3.¹⁴⁵⁶

The refrigeration energy savings can be calculated based on above numbers:

$$\text{Refrigeration energy savings (Baseline 1, med-temp, per motor)} = 117.734 \text{ kWh}$$

$$\text{Refrigeration energy savings (Baseline 1, low-temp, per motor)} = 221.708 \text{ kWh}$$

$$\text{Refrigeration energy savings (Baseline 2, med-temp, per motor)} = 21.724 \text{ kWh}$$

$$\text{Refrigeration energy savings (Baseline 2, low-temp, per motor)} = 40.910 \text{ kWh}$$

The overall energy savings are the sums of the motor energy savings and the refrigeration energy savings:

$$\text{Overall energy savings (Baseline 1, med-temp, per motor)} = 412.070 \text{ kWh}$$

$$\text{Overall energy savings (Baseline 1, low-temp, per motor)} = 509.929 \text{ kWh}$$

$$\text{Overall energy savings (Baseline 2, med-temp, per motor)} = 76.036 \text{ kWh}$$

$$\text{Overall energy savings (Baseline 2, low-temp, per motor)} = 94.094 \text{ kWh}$$

For walk-in coolers and freezers:

The electrical energy savings for replacing a shaded-pole motor with a Q-Sync motor in a retrofit project is calculated by the difference of the two motors demonstrated power draw multiplied by the annual operating hours. For coolers, T is 8,760 hours. For freezers, T is 8,578 hours considering daily 30-minute defrost cycles during which fans are not powered.

$$\text{Motor energy savings (Baseline 1, med-temp, per motor)}$$

$$= (120.4 \text{ W} - 37.2 \text{ W}) \times 8760 \text{ hours} / 1000 = 728.832 \text{ kWh}$$

$$\text{Motor energy savings (Baseline 1, low-temp, per motor)}$$

$$= (120.4 \text{ W} - 37.2 \text{ W}) \times 8578 \text{ hours} / 1000 = 713.690 \text{ kWh}$$

The electrical energy savings for replacing a PSC motor with a Q-Sync motor in a retrofit project is calculated by the difference of the two motors demonstrated power draw multiplied by the annual operating hours (8760 hours):

$$\text{Motor energy savings (Baseline 3, med-temp, per motor)}$$

$$= (61.3 \text{ W} - 37.2 \text{ W}) \times 8760 \text{ hours} / 1000 = 211.116 \text{ kWh}$$

$$\text{Motor energy savings (Baseline 3, low-temp, per motor)}$$

$$= (61.3 \text{ W} - 37.2 \text{ W}) \times 8578 \text{ hours} / 1000 = 206.730 \text{ kWh}$$

The reduced motor power will also reduce refrigeration load. Assuming the power to drive the evaporator fan is converted to heat inside the display cases at 100% rate, the reduction in refrigeration system compressor power can be calculated using the following equation:

¹⁴⁵⁵ Michael Deru, et al, "U.S. Department of Energy Commercial Reference Building Models of National Building Stock," NREL Report TP-5500-46861, February 2011.

¹⁴⁵⁶ Michael Deru, et al, "U.S. Department of Energy Commercial Reference Building Models of National Building Stock," NREL Report TP-5500-46861, February 2011.

$$\Delta kWh_{refrigeration} = \frac{\Delta kWh_{motor}}{COP},$$

where COP is the Coefficient of Performance of refrigeration systems in the supermarket display cases. For med-temperature cases, the average COP is 2.5. For low-temp freezer cases, the average COP is 1.3.

The refrigeration energy savings can be calculated based on above numbers:

Refrigeration energy savings (Baseline 1, med-temp, per motor) = 291.532 kWh

Refrigeration energy savings (Baseline 1, low-temp, per motor) = 548.992 kWh

Refrigeration energy savings (Baseline 3, med-temp, per motor) = 84.446 kWh

Refrigeration energy savings (Baseline 3, low-temp, per motor) = 159.023 kWh

The overall energy savings are the sums of the motor energy savings and the refrigeration energy savings:

Overall energy savings (Baseline 1, med-temp, per motor) = 1020.364 kWh

Overall energy savings (Baseline 1, low-temp, per motor) = 1262.682 kWh

Overall energy savings (Baseline 3, med-temp, per motor) = 295.562 kWh

Overall energy savings (Baseline 3, low-temp, per motor) = 365.753 kWh

ELECTRIC ENERGY SAVINGS

If the numbers of existing shaded-pole motors, EC motors to be retrofitted are known (Baseline 1,2, & 3):

$$\Delta kWh = \text{Overall annual savings per motor} * \text{Motors}$$

Where overall energy savings per motor can be as specified in the following table:

Evaporator Fan Motor Rating (of Q-Sync motor)	Baseline	Annual kWh Savings/motor
9-12W	shaded-pole motor, med-temp	412.070
9-12W	shaded-pole motor, low-temp	509.929
9-12W	EC motor, med-temp	76.036
9-12W	EC motor, low-temp	94.094
38-50W	shaded-pole motor, med-temp	1,020.364
38-50W	shaded-pole motor, low-temp	1,262.682
38-50W	PSC motor, med-temp	295.562
38-50W	PSC motor, low-temp	365.753

Motors = number of fan motors replaced

For refrigerated display cases, if the numbers of existing shaded-pole motors and EC motors are unknown in a retrofit project (Baseline 3):

$$\Delta kWh = [W_{med-temp} (W_{SPM} \times S_{SPM-med} + W_{ECM} \times S_{ECM-med}) + W_{low-temp} (W_{SPM} \times S_{SPM-low} + W_{ECM} \times S_{ECM-low})] * \text{Motors}$$

Motors = number of fan motors replaced

S = annual energy savings per motor, by type. Savings for each different type ($S_{SPM-med}$, $S_{SPM-low}$, $S_{ECM-med}$, $S_{ECM-low}$) can be looked up from the table above.

W = weighting factors. The weights for the medium-temperature and low-temperature applications ($W_{med-temp}$ and $W_{low-temp}$) should be calculated based on the actual numbers of motors in a retrofit project, and the sum of the two weights should equal to 1. If these weights cannot be accurately obtained, the estimated weights ($W_{med-temp}^*$ and W_{low-

$temp^*$)¹⁴⁵⁷ from the table below can be used (the W_{SPM} and W_{ECM} numbers are slightly adjusted by +/-5% based on national averages in the 2015 ORNL study, reflecting some shaded pole motors may have been replaced with EC motors in the past few years).¹⁴⁵⁸

Application	WSPM	WECM	Wmed-temp*	Wlow-temp*
Supermarkets	0.6	0.4	0.68	0.32
Other Food Retail Formats	0.8	0.2	0.68	0.32
Other Retail Categories	0.7	0.3	0.68	0.32
Restaurants and Bars	0.85	0.15	0.68	0.32
Beverage Vending Machines	0.85	0.15	0.68	0.32

For walk-in coolers and freezers, if the existing motor types are unknown in a retrofit project, it can be assumed they are PSC motors, as from industry survey in the 2018 ORNL study,¹⁴⁵⁹ 95% of the 38-50 watt evaporator fan motors are PSC motors.

SUMMER COINCIDENT PEAK DEMAND SAVINGS

$$\Delta kW = \Delta kWh / \text{Hours} * CF$$

Where:

ΔkWh = Gross customer annual kWh savings for the measure, as listed above

Hours = Full Load hours per year
 = 8,766 (med-temp); 8,578 (low-temp)

CF = Summer Peak Coincident Factor
 = 1.0

Other variables as defined above.

The following table provides the resulting kW savings (per motor):

Evaporator Fan Motor Rating (of Q-Sync motor)	Baseline	kW Savings/motor
9-12W	shaded-pole motor, med-temp	0.047
9-12W	shaded-pole motor, low-temp	0.059
9-12W	EC motor, med-temp	0.009
9-12W	EC motor, low-temp	0.011
38-50W	shaded-pole motor, med-temp	0.116
38-50W	shaded-pole motor, low-temp	0.147
38-50W	PSC motor, med-temp	0.034
38-50W	PSC motor, low-temp	0.043

FOSSIL FUEL SAVINGS

N/A

¹⁴⁵⁷ ASHRAE, “ASHRAE Handbook – Refrigeration,” ASHRAE, 2018.

¹⁴⁵⁸ NCI (Navigant Consulting Inc.) and PNNL (Pacific Northwest National Laboratory), “Preliminary Technical Support Document (TSD): Energy Conservation Program for Certain Commercial and Industrial Equipment: Commercial Refrigeration Equipment,” Appliances and Commercial Equipment Standards, Building Technologies Program, Office of Energy Efficiency and Renewable Energy, US Department of Energy, Washington, D.C., 2011.

¹⁴⁵⁹ Brian A. Fricke and Bryan R. Becker, “Permanent Magnet Synchronous Motors for Commercial Refrigeration: Final Report,” Oak Ridge National Laboratory, July 2018.

WATER AND OTHER NON-ENERGY IMPACT DESCRIPTIONS AND CALCULATION

N/A

DEEMED O&M COST ADJUSTMENT CALCULATION

There is no O&M cost adjustment for replacing shaded pole or EC motors with Q-Sync motors in reach-in refrigerated display case applications. From the 2015 ORNL study,¹⁴⁶⁰ the 2016 AESC study,¹⁴⁶¹ and the manufacturer,¹⁴⁶² there is no expected degradation in equipment performance after the retrofits, and therefore no O&M cost differences are expected between baseline and efficient measures.

MEASURE CODE: CI-RFG-QMF-V03-220101

REVIEW DEADLINE: 1/1/2026

¹⁴⁶⁰ Brian A. Fricke and Bryan R. Becker, "Q-Sync Motors in Commercial Refrigeration: Preliminary Test Results and Projected Benefits," Oak Ridge National Laboratory, September 2015.

¹⁴⁶¹ M M. Valmiki and Antonio Corradini, "Energy Savings of Permanent Magnet Synchronous Fan Motor Assembly Refrigerated Case Evaporators," Alternative Energy Systems Consulting, August 2016.

¹⁴⁶² Based on communication with QM Power representative, August 22, 2018. See reference document "8.22.2018 Email.msg".

4.6.12 Variable Speed Drive for Condenser Fans

DESCRIPTION

This measure is applicable to VFDs installed on condenser fan motors operating in supermarket refrigeration systems.

Where a baseline condenser motor load operates at a fixed-speed, VFDs generate energy and cost savings by modulating frequency and voltage to match the load on the condensers.¹⁴⁶³ Savings result from the resulting fan speed variation.

This measure is applicable to motors between 0.5 horsepower and 1.5 horsepower.

This measure was developed to be applicable to the following program types: RF, TOS.

If applied to other program types, the measure savings should be verified.

DEFINITION OF EFFICIENT EQUIPMENT

This measure applies to retrofitted installation of condenser fan motors in supermarkets where no ability to modulate frequency and voltage for fan-speed variation exists. Savings are based on the application of VFDs to baseline load conditions defined as pre-installation load compared to post-installation load.

DEFINITION OF BASELINE EQUIPMENT

The time-of-sale baseline is a new motor installed without a VFD or other methods of control. Retrofit baseline is an existing motor operating as is.

DEEMED LIFETIME OF EFFICIENT EQUIPMENT

The expected measure life for VFD condenser fan applications is 15 years.¹⁴⁶⁴

DEEMED MEASURE COST

Customer costs will be used when available. For motor sizes 0.5 to 1.5 HP the default measure cost is \$1,170/HP. Custom costs must be gathered for other motor sizes.

LOADSHAPE

C22-commercial refrigeration.

COINCIDENCE FACTOR

The demand savings factor (DSF) is already based upon coincident savings, and thus there is no additional coincidence factor for this characterization.

Algorithm

CALCULATION OF ENERGY SAVINGS

Energy savings is based on a pre- and post-treatment test. The pre-treatment period being nearly three months in duration with post-treatment of a similar period. Both periods include significant average outdoor temperature (OAT) changes. Measurement of energy savings relies on regression of condenser fan energy use against ambient temperature. These estimates were made on each condenser using both pre- and post-VFD installation; comparison of the two yields savings.¹⁴⁶⁵

¹⁴⁶³ Romberger, Jeff. Wed. "Chapter 18: Variable Frequency Drive Evaluation Protocol. The Uniform Methods Project: Methods for Determining Energy Efficiency Savings for Specific Measures". United States. doi:10.2172/1365710.

¹⁴⁶⁴ Efficiency Vermont TRM 3/16/2015 pp 19 for motor end use-variable frequency drives.

¹⁴⁶⁵ Pre- and post-VFD retrofit kWh consumption were derived from measurement of 14 condensers at 4 supermarkets in Rockford, IL. Annual savings in each Zone is the product of the number of hours in each 5-degree F Typical Meteorological Year

ELECTRIC ENERGY SAVINGS

$$\text{Annual } \Delta\text{kWh}_{\text{condenser}} = \text{No. fans} * \text{HP/fan} * \text{kWh savings/HP/Zone}$$

Zone	kWh savings/HP
1 (Rockford)	1,480
2 (Chicago)	1,500
3 (Springfield)	1,430
4 (Belleville)	1,430
5 (Marion)	1,480

For example, for a condenser with 5 fans, each rated at 1.5 HP in Chicago (Zone 2):

$$\text{Annual } \Delta\text{kWh}_{\text{condenser}} = 5 * 1.5 * 1,500$$

$$= 11,250 \text{ kWh}$$

SUMMER COINCIDENT PEAK DEMAND SAVINGS

N/A

FOSSIL FUEL SAVINGS

N/A

WATER AND OTHER NON-ENERGY IMPACT DESCRIPTIONS AND CALCULATION

N/A

DEEMED O&M COST ADJUSTMENT CALCULATION

Variable frequency drives, anecdotally, increase motor life because they allow for soft-start and soft shutdown. This would lead to O&M savings from replacing motors. Unfortunately, there is currently insufficient evidence to quantify this savings, so no deemed O&M savings can be claimed at this time.

MEASURE CODE: CI-RFG-VSC-V03-250101

REVIEW DEADLINE: 1/1/2029

temperature bin multiplied by the mean savings across the 14 condensers measured in the study. These estimates represent means from 10,000 simulations that include confidence intervals at the 90 percent level of +/-330, +/-330, +/-300, +/-320, and +/-310 for zones 1, 2, 3, 4, and 5, respectively. Detailed methods, assumptions, and calculations are found in “Variable Frequency Drive Energy Savings in Refrigeration Condensers Report. Slipstream, October, 9 2019”

4.6.13 Add Doors to Open Refrigerated Display Cases

DESCRIPTION

Open display cases are typically found in grocery and convenience stores and have been a preference of store owners because they allow customers a clear view and easy access to refrigerated products. This measure is retrofitting existing, open, refrigerated display cases by adding and installing doors. The baseline equipment is an open vertical or horizontal display case with no doors or covering. The efficient equipment is the installation of solid doors on the existing display case. Replacement of open display cases with new display cases with doors is not covered under this measure characterization.

Energy savings are based on air infiltration reduction from the addition of doors to the open display cases. The air infiltration reductions assume a reduced heat gain and subsequent reduced load on the refrigeration compressors. Both radiant and conduction heat losses were factored into the analysis as well. Energy savings are based on a per linear foot of display case.

Interactive HVAC energy savings were also included in the measure savings analysis. The HVAC interactive effects calculation assesses the measure's impact on the heating and cooling equipment. With adding a door to an open refrigerated display case, excess cold air leaking into the conditioned space no longer has to be treated by the heating system, resulting in additive savings. Similarly, the reduction in cold air from the open refrigerated display case no longer supplements the efforts of the space cooling equipment, which results in an overall increase in its consumption.

High, medium, and low temperature cases are eligible for this measure; however, the measure assumptions detailed in this characterization are based on medium temperature display cases, with the installation of zero energy doors, as it was deemed the most likely candidate for participation in this measure. Open low temperature or freezer display cases are not common. If the retrofitted door has LED fixtures, it is recommended to leverage '4.5.4 LED Bulbs and Fixtures' for quantifying savings and measure benefits.

This measure was developed to be applicable to the following program types: RF.

If applied to other program types, the measure savings should be verified.

DEFINITION OF EFFICIENT EQUIPMENT

The efficient condition is retrofitting an existing open, refrigerated, display case by adding doors.

DEFINITION OF BASELINE EQUIPMENT

The baseline condition is an open, refrigerated, display case without any covering.

DEEMED LIFETIME OF EFFICIENT EQUIPMENT

The expected measure life is 15 years.¹⁴⁶⁶

DEEMED MEASURE COST

The incremental cost, which includes both material and labor, differs depending on whether or not the installed door is equipped with LED lighting. The estimated incremental cost for doors without LED lighting is \$390 per linear foot. The incremental cost for doors with LED lighting is \$419 per linear foot.¹⁴⁶⁷

¹⁴⁶⁶ The measure life is sourced from the PG&E Workpaper, "Add Doors to Open Medium Temperature Cases – PGE3PREF116 R3", June 2019.

¹⁴⁶⁷ The incremental cost is sourced from the PG&E Workpaper, "Add Doors to Open Medium Temperature Cases – PGE3PREF116 R3", June 2019. The incremental cost for retrofitting new doors on existing refrigerated display cases is the material cost of the door and the labor cost required for installation. The material cost of the doors is \$331 per linear foot with LED lighting and \$301 per linear foot without LED lighting. And the installation cost is \$88 per linear foot.

LOADSHAPE

Loadshape C03 - Commercial Cooling

Loadshape 22: Commercial Refrigeration

COINCIDENCE FACTOR

There are two components to the demand savings of this measure, one that impacts the refrigeration equipment itself, and another that has an interactive impact on the space cooling equipment. As a result, the measure details two summer coincidence peak demand factors.

Algorithm

CALCULATION OF SAVINGS

ELECTRIC ENERGY SAVINGS

$$\Delta kWh = ((\Delta HG * CL) / (EER * 1000) * 8760) + (MMBtu_{HVAC\ Cool} * CL * (1 / SEER) * 1000) - kWh_{Night\ Covers} - kWh_{Added\ Lights}$$

Where:

- ΔkWh = gross customer annual kWh savings
- ΔHG = Heat Gain, the decreased load or the reduced heat gain on the open refrigerated display case with the installation of a door (Btu/hr-linear foot)
= 1,172 Btu/h-ft¹⁴⁶⁸ for vertical cases or 202.3 Btu/h-ft for horizontal cases¹⁴⁶⁹.
- CL = Case Length, refrigerated case length in feet
= Actual
- EER = Energy Efficiency Ratio; display case compressor efficiency (Btu/hr-watt)
= 11.36¹⁴⁷⁰
- 1000 = Conversion from watts to kilowatts (W / kW)
- 8760 = Annual operating hours of the refrigerated display case¹⁴⁷¹
- MMBtu_{HVAC Cool} = Total cooling load increase on the HVAC equipment per linear foot of display case. Varies by location:¹⁴⁷²

¹⁴⁶⁸ The change in heat gain is sourced as the typical value for a medium temperature vertical display case adding doors from the PG&E Workpaper, "Add Doors to Open Medium Temperature Cases - PGE3PREF116 R3", June 2019. The workpaper assumes a net reduction in heat gain with the installation of doors on open refrigerated display cases. The primary benefits account for the decrease in excess heat entering the display case from air infiltration. Radiation and conduction heat gains were also included in the derivation of this value. Additionally, the net heat gain has built in assumptions on how often the refrigerated case doors will be used and the display case accessed by customers and site associates, reducing some of the air infiltration benefits of the new door.

¹⁴⁶⁹ Average load difference between Hussmann open horizontal cases and lid horizontal cases across various configurations.

¹⁴⁷⁰ Average EER values were calculated as the average of standard reciprocating and discus compressor efficiencies, using a typical condensing temperature of 90°F and saturated suction temperatures (SST) of 20°F for medium temperature applications. The efficiency analysis and product review is sourced from the Efficiency Vermont TRM, which utilizes data from Emerson Climate Technology software. Medium temperature cases have an EER value of 11.36.

¹⁴⁷¹ The measure assumes the baseline equipment is not employing night covers or any other covering but is in fact left open for the duration of its operation.

¹⁴⁷² The MMBtu increase on the HVAC cooling equipment is based on an outdoor air temperature bin analysis, the total hours of operation of the cooling system, and the building's overall loss of additional cooling as a result of the installation of the doors on the open refrigerated display case. The analysis assumes a certain amount of conditioned air has to be treated to replace the

Zone	MMBtu _{HVAC Cool Vertical}	MMBtu _{HVAC Cool Horizontal}
1 (Rockford)	-2.632	-0.454
2 (Chicago)	-2.763	-0.477
3 (Springfield)	-3.284	-0.567
4 (Belleville)	-3.254	-0.562
5 (Marion)	-3.335	-0.576

SEER = Seasonal Energy Efficiency Ratio; HVAC equipment operating efficiency (Btu/hr-watt)
 = 13.00¹⁴⁷³

kWh_{Night Covers} = Reduction in energy savings if existing display case utilizes night covers (kWh/linear-ft)
 = 0 if no night covers are deployed. See table below if display case uses night covers.

Display Case Description	Case Temperature Range (°F)	ΔkWh/ft reduction (= 9% reduction of electricity use ^{1474,1475})
Vertical Open, Remote Condensing, Medium Temperature	35°F to 55°F	131
Vertical Open, Remote Condensing, Low Temperature	0°F to 30°F	296
Vertical Open, Self-Contained Medium Temperature	35°F to 55°F	252

kWh_{Added Lights} = Reduction in energy savings if new lighting is added to the case (kWh/linear-ft)
 = 0 if no lighting is added, or if lighting is added but existing lighting is removed. If lighting is retrofit, determine case lighting savings using '4.5.4 LED Bulbs and Fixtures'.
 = Actual installed equipment specifications or use case lighting values from '4.5.4 LED Bulbs and Fixtures'.

For example, a grocery store in Chicago installed zero energy doors on four open refrigerated cases that do not use night covers, which amounted to 12 linear feet of retrofitted display cases, savings the site:

$$\Delta kWh = ((1172 * 12) / (11.36 * 1000) * 8760) + (-2.763 * 12 * (1 / 13) * 1000)$$

$$= 8,295 kWh$$

air previously cooled by the display case. Furthermore, the analysis assumes an increased load on the cooling system, at outdoor temperatures above 60°F. A 25% disabling factor was also applied to account for some of the cold air pouring out of the display case and subcooling the site's conditioned space, which will not trigger a thermostatic response from the HVAC equipment. For more information on the analysis used to derive the load increase on the HVAC cooling equipment per linear foot of display case, please see the 'HVAC IE' tab in the "IL TRM_Add Doors_Analysis_Mar 2021.xlsx".

¹⁴⁷³ In light of limited existing market data for the efficiency of commercial air condition equipment in Iowa grocery and convenience stores, SEER assumptions are conservatively sourced from IECC 2012.

¹⁴⁷⁴ Southern California Edison Refrigeration Technology and Test Center. Effects of the Low Emissivity Shields on Performance and Power Use of a Refrigerated Display Case. 1997. Southern California Edison, Rancho Cucamonga, CA. See '4.6.9 Night Covers' for more detail.

¹⁴⁷⁵ Technischer Überwachungs-Verein Rheinland E.V. Laboratory test results for energy savings on refrigerated dairy case, conducted for Econofrost. See '4.6.9 Night Covers' for more detail.

SUMMER COINCIDENT PEAK DEMAND SAVINGS

$$\Delta kW = (((\Delta HG * CL) / (EER * 1000) - kW_{Added\ Lights}) * CF_{Refrigeration}) + ((MMBtu_{HVAC\ Cool} / Hours_{Cool} * CL * (1 / SEER) * 1000) * CF_{Cool})$$

Where:

Hours_{Cool} = Total combined hours the site is providing cooling. Varies by location:¹⁴⁷⁶

Zone	Hours _{Cool}
1 (Rockford)	2,994
2 (Chicago)	3,143
3 (Springfield)	3,736
4 (Belleville)	3,702
5 (Marion)	3,794

kW_{Added Lights} = Reduction in demand savings if new lighting is added to the case (kW/linear-ft)
 = 0 if no lighting is added, or if lighting is added but existing lighting is removed. If lighting is retrofit, determine case lighting savings using '4.5.4 LED Bulbs and Fixtures'.
 = Actual installed equipment specifications or use case lighting values from '4.5.4 LED Bulbs and Fixtures'.

CF_{Refrigeration} = Summer peak coincidence factor for the refrigerated display case
 = 0.964

CF_{Cool} = Summer peak coincidence factor for the HVAC cooling system. This is the summer system peak coincidence factor for commercial cooling (during system peak hours)
 = 0.913¹⁴⁷⁷

FOSSIL FUEL SAVINGS

$$\Delta Therms = (MMBtu_{HVAC\ Heat} * CL * (1 / AFUE) * 10$$

Where:

ΔTherms = gross customer annual therms savings

MMBtu_{HVAC Heat} = Total heating load decrease on the HVAC equipment per linear foot of display case. Varies by locations:¹⁴⁷⁸

¹⁴⁷⁶ The total combined hours in which the site is providing cooling is based on an outdoor air temperature bin analysis, where the site is conditioning cold air at outdoor temperatures of 60°F and above. Weather data was sourced from TMY3 data for the specific locations. For more information on the derivation of these hours, please see 'HVAC IE' tab in the "IL TRM_Add Doors_Analysis_Mar 2021.xlsx" Night covers are not included in the peak demand savings algorithm because night covers are deployed at night, outside of the peak demand period.

¹⁴⁷⁷ Based on analysis of Itron eShape data for Missouri, calibrated to Illinois loads, supplied by Ameren. The AC load during the utility's peak hour is divided by the maximum AC load during the year.

¹⁴⁷⁸ The MMBtu decrease on the HVAC heating equipment is based on an outdoor air temperature bin analysis, the total hours of operation in which the site is providing heat, and the building's overall reduced heating load as a result of the installation of the doors on the open refrigerated display case. The analysis assumes a certain reduction of conditioned air that had to be treated to make up for the air previously cooled by the display case. The reduced heat gain on the refrigerated display case equals the reduced heat loss by the site and a heating load that no longer has to be provided by the HVAC system. Furthermore, the analysis assumes a decrease load on the heating system, at outdoor temperatures below 60°F. A 25% disabling factor was also applied to account for some of the cold air pouring out of the display case and subcooling the site's

Zone	MMBtu _{HVAC Heat Vertical}	MMBtu _{HVAC Heat Horizontal}
1 (Rockford)	5.068	0.875
2 (Chicago)	4.937	0.852
3 (Springfield)	4.416	0.762
4 (Belleville)	4.446	0.767
5 (Marion)	4.365	0.753

- CL = Case Length, refrigerated case length in feet
- = Actual
- AFUE = 80%¹⁴⁷⁹
- 10 = Conversion from MMBtu to therms

WATER IMPACT DESCRIPTIONS AND CALCULATION

N/A

DEEMED O&M COST ADJUSTMENT CALCULATION

N/A

MEASURE CODE: CI-RFG-DOOR-V02-220101

REVIEW DEADLINE: 1/1/2025

conditioned space, which will not trigger a thermostatic response from the HVAC equipment. For more information on the analysis used to derive the load decrease on the HVAC heating equipment per linear foot of display case, please see the 'HVAC IE' tab in the "IL TRM_Add Doors_Analysis_Mar 2021.xlsx".

¹⁴⁷⁹ Typical heating system efficiency of 80%, consistent with current heating efficiency assumptions for lighting HVAC interactive effects for commercial fossil fuel-fired systems.

4.6.14 Floating Head Pressure Control

DESCRIPTION

Installers conventionally design a refrigeration system to condense at a set pressure-temperature setpoint, typically 90 degrees. By installing a “floating head pressure control” condenser system, the refrigeration system can change condensing temperatures in response to different outdoor temperatures. This means that as the outdoor temperature drops, the compressor will not have to work as hard to reject heat from the cooler or freezer. This measure is for the application of floating head pressure controls for compressors ≤ 10HP and a condensing temperature set to 70°F. This measure is strictly limited to single compressor systems.

This measure was developed to be applicable to the following program types: RF.

If applied to other program types, the measure savings should be verified. IECC code requires economizers in certain instances and therefore projects relying on code baseline definitions must verify eligibility.

DEFINITION OF EFFICIENT EQUIPMENT

High efficiency is a refrigeration system with floating head pressure control.

DEFINITION OF BASELINE EQUIPMENT

The baseline is a refrigeration system without floating head pressure control.

DEEMED LIFETIME OF EFFICIENT EQUIPMENT

The expected measure life is 15 years¹⁴⁸⁰.

DEEMED MEASURE COST

Floating Head Pressure Control Costs, per Horsepower (condenser rating) are as follows (\$/HP)¹⁴⁸¹:

Unit Type	Low Temperature (Freezer)	Medium Temperature (Refrigerator)	Unknown Temperature ¹⁴⁸²
Self- Contained Unit	\$411.87	\$449.79	\$430.83
Remote Condensing Unit	\$411.87	\$449.79	\$430.83
Unknown ¹⁴⁸³	\$411.87	\$449.79	\$430.83

LOADSHAPE

Loadshape C22 - Commercial Refrigeration

COINCIDENCE FACTOR

The summer peak coincidence factor for this measure is assumed to be 0%, based on the fact that savings for this measure will occur during periods of coldest outdoor temperatures.

¹⁴⁸⁰ California DEER 2014 Effective Useful Life (EUL) table.

¹⁴⁸¹ Costs are based on number of additional valves per condenser motor for different HP ratings and includes installation labor costs. Costs are averaged and shown on a per HP basis. See reference document ComGroceryFHPCSingleCompressor_v2_1.xlsm, worksheet 'CostData&Analysis,' blue highlighted cells. A comparison of prevailing wages in the Pacific Northwest showed high similarity to Illinois and therefore a simple inflation technique (using the US BLS's CPI Inflation Calculator, comparing the purchasing power of \$1.00 in January 2012 to May 2021) was used to convert 2012\$ to 2021\$ (a multiplier of 1.19).

¹⁴⁸² Unknown values based on weighted average; 2010 ASHRAE Refrigeration Handbook, page 15.1 “Medium- and low-temperature display refrigerator line-ups account for roughly 68% and 32%, respectively, of a typical supermarket’s total display refrigerators.

¹⁴⁸³ For unit type unknown, it is assumed 50/50 split of self-contained and remote condensing units.

Algorithm

CALCULATION OF ENERGY SAVINGS

ELECTRIC ENERGY SAVINGS

$$\Delta kWh = HP * kWh_{HP}$$

Where:

HP = Horsepower of Compressor
 = actual installed

kWh_{HP} = Savings factor, kWh per horsepower of compressor rating. Per the tables below based on weather zone, condensing unit type, and temperature range¹⁴⁸⁴:

Note: Self-contained condensing units assume heat is rejected to conditioned or semi-conditioned space. Therefore, outdoor air temperature is not considered a critical system variable resulting in identical savings across weather zones that are much lower compared to those realized by remove condensing units that reject heat to the outdoor environment.

Zone 1 (Rockford)

Unit Type	Low Temperature (Freezer)	Medium Temperature (Refrigerator)	Unknown Temperature
Self- Contained Unit	252	131	170
Remote Condensing Unit	482	451	461
Unknown	367	291	315

Zone 2 (Chicago)

Unit Type	Low Temperature (Freezer)	Medium Temperature (Refrigerator)	Unknown Temperature
Self- Contained Unit	252	131	170
Remote Condensing Unit	465	435	445
Unknown	358	283	307

Zone 3 (Springfield)

Unit Type	Low Temperature (Freezer)	Medium Temperature (Refrigerator)	Unknown Temperature
Self- Contained Unit	252	131	170
Remote Condensing Unit	403	377	385

¹⁴⁸⁴ Derived from RTF saving estimates for the NW climate zone and extrapolated to Illinois climate zones by using heating degree-days for a 65 degree F setpoint as established in Measure 4.4.37 Unitary HVAC Condensing Furnace measure. See reference file "fhp-savings-extrapolation-xlsx-Adjusted for Illinois.xlsx," 2021.

Unknown	327	254	278
---------	-----	-----	-----

Zone 4 (Belleville)

Unit Type	Low Temperature (Freezer)	Medium Temperature (Refrigerator)	Unknown Temperature
Self- Contained Unit	252	131	170
Remote Condensing Unit	321	301	307
Unknown	287	216	239

Zone 5 (Marion)

Unit Type	Low Temperature (Freezer)	Medium Temperature (Refrigerator)	Unknown Temperature
Self- Contained Unit	252	131	170
Remote Condensing Unit	328	307	314
Unknown	290	219	242

For example, a low temperature remote condensing unit in Chicago (Zone 2) with a 3-horsepower condenser would annually save:

$$\begin{aligned} \Delta\text{kWh} &= 3 * 465 \\ &= 1,395 \text{ kWh} \end{aligned}$$

SUMMER COINCIDENT PEAK DEMAND SAVINGS

There are no expected summer coincident peak demand savings for this measure.

FOSSIL FUEL SAVINGS

There are no expected fossil fuel gas savings for this measure.

WATER IMPACT DESCRIPTIONS AND CALCULATION

N/A

DEEMED O&M COST ADJUSTMENT CALCULATION

N/A

MEASURE CODE: CI-RFG-FHP-V01-220101

REVIEW DEADLINE: 1/1/2026

4.6.15 Zero Energy Doors for Refrigerated Cases

DESCRIPTION

This measure was developed to reduce the use of electric resistance heaters that prevent the formation of condensation on refrigerated case doors. Standard refrigerated case doors include anti-condensation heaters in the frames, doors, or within the glass to prevent condensation from forming and obstructing view of refrigerated products. High efficiency, zero-energy doors are designed to prevent condensation using multiple layers of glass, low-conductivity filler gas, low-emissivity glass coatings, non-metallic spacers to separate glass panes, and/or non-metallic frames to prevent condensation. Energy savings from zero energy case doors are associated with the elimination of the anti-sweat heaters, as well as the resulting reduction of the load on the refrigeration and building cooling systems. This measure covers the replacement of standard doors with anti-sweat heaters with new zero energy doors on existing refrigerated cases.

This measure is not applicable to retrofitting existing open cases with new doors, a scenario that is covered by the existing measure 4.6.13, Adding Doors to Open Refrigerated Display Cases. It should be noted that the assumptions for measure 4.6.13 are based on installing zero energy doors on existing open medium temperature display cases.

This measure cannot be used in conjunction with measure 4.6.3, Door Heater Controls for Cooler or Freezer.

This measure may be used in conjunction with measure 4.5.4, LED Bulbs and Fixtures, if the installed door has integrated LED lighting, or new LED lighting is installed as part of a door retrofit.

This measure was developed to be applicable to the following program types: RF.

If applied to other program types, the measure savings should be verified.

DEFINITION OF EFFICIENT EQUIPMENT

The efficient equipment is a refrigerated display case door designed to prevent condensation without the use of anti-sweat glass or frame heaters. Qualifying doors will have heat-reflective treated glass and have multiple glass panes with a low-conductivity gas fill.

DEFINITION OF BASELINE EQUIPMENT

The baseline equipment is a standard refrigerated display case door that uses anti-sweat glass and/or frame heaters to prevent condensation. Standard doors may have anti-sweat heater controls installed.

DEEMED LIFETIME OF EFFICIENT EQUIPMENT

The effective useful life for this measure is 12 years.¹⁴⁸⁵

DEEMED MEASURE COST

The measure cost is assumed to be \$601.80 (material cost per door) plus \$132.78 (labor cost per door) = \$734.58 per door.¹⁴⁸⁶

LOADSHAPE

Loadshape C22 - Commercial Refrigeration

¹⁴⁸⁵ Effective measure life is per Southern California Edison Company, Work Paper SWCR002-02, "Low-Temperature Display Case Doors with no Anti-Sweat Heaters" Revision 2, April 2022

¹⁴⁸⁶ Measure cost per Southern California Edison Company, Work Paper SWCR002-02, "Low-Temperature Display Case Doors with no Anti-Sweat Heaters" Revision 2, April 2022

COINCIDENCE FACTOR

The peak kW coincidence factor is 66%¹⁴⁸⁷.

Algorithm

CALCULATION OF ENERGY SAVINGS

ELECTRIC ENERGY SAVINGS

$$\Delta kWh = kW_{base} * NUM_{doors} * Hours * \%ASH * BF$$

Where

- kW_{base} = connected load kW for standard freezer or cooler display case door with anti-sweat heaters. If actual kW_{base} is unknown, assume 0.230 kW for freezer and 0.066 kW for cooler cases.¹⁴⁸⁸
- NUM_{doors} = number of display case doors replaced or installed on new case
- Hours = Hours per year, 8766
- %ASH = percentage of annual hours anti-sweat heaters are operating. Assume 90.7% if no anti-sweat heater controls exist and 45.6% if existing case doors have functional anti-sweat heater controls installed.¹⁴⁸⁹ For installation of doors on new cases, assume that the baseline case uses anti-sweat heater controls¹⁴⁹⁰.
- BF = Bonus Factor; represents the increased savings due to reduction in refrigeration load and the reduction in building cooling load. Assume 1.5 for freezer cases and 1.3 for cooler cases.¹⁴⁹¹

For example, a bank of 10 reach-in cooler doors without anti-sweat heater controls are replaced with zero energy doors and would annually save:

$$\begin{aligned} \Delta kWh &= 0.066 * 10 * 8766 * 0.907 * 1.3 \\ &= 6,822 \text{ kWh} \end{aligned}$$

SUMMER COINCIDENT PEAK DEMAND SAVINGS

$$\Delta kW = (\Delta kWh / 8766) * CF$$

Where

- CF = Summer peak coincident factor for measure, 66%

¹⁴⁸⁷ The coincidence factor reflects the elimination of anti-sweat heaters and is derived from the average load reduction from controlled heaters vs. non-controlled heater, see section 4.6.3.

¹⁴⁸⁸ kW_{base}/door are per Section 4.6.3 of the Illinois Statewide Technical Reference Manual, Version 12, p. 801

¹⁴⁸⁹ NEEP Refrigeration Loadshape Report. The Cadmus Group, Commercial Refrigeration Loadshape Project Final Report, Northeast Energy Efficiency Partnerships, Regional Evaluation, Measurement, and Verification Forum, Lexington, MA 2015 (p. 7)

¹⁴⁹⁰ This assumption is based on the efficiency requirements for display doors in the 2021 International Energy Conservation Code (IECC), C403.11.2.1 Performance Standards, which in new installations would make door heater controls necessary when using the kW_{base} assumptions above.

¹⁴⁹¹ Ibid., p. 8

FOSSIL FUEL SAVINGS

There are no expected fossil fuel gas savings for this measure.

WATER IMPACT DESCRIPTIONS AND CALCULATION

N/A

DEEMED O&M COST ADJUSTMENT CALCULATION

N/A

MEASURE CODE: CI-RFG-ZED-V01-250101

REVIEW DEADLINE: 1/1/2027

4.6.16 Door Gaskets for Walk-in and Reach-in Coolers and Freezers

DESCRIPTION

This measure characterizes the savings associated with installing new door gaskets on existing refrigerated cases and walk-in units where the existing gasket has been worn to the point where it no longer provides an effective seal. Tight fitting gaskets inhibit infiltration of warm, moist air into the cold refrigerated space, thereby reducing the cooling load. The reduction of moisture in the case also helps prevent frost on the evaporator coil. Frost buildup on the coil reduces the heat transfer effectiveness, reduces air passage, and increases energy use during the defrost cycle. Therefore, replacing defective door gaskets reduces compressor run time and improves the overall effectiveness of heat removal from a refrigerated cabinet or walk-in unit.

This measure was developed to be applicable to the following program types: RF.

If applied to other program types, the measure savings should be verified.

DEFINITION OF EFFICIENT EQUIPMENT

In order for this characterization to apply, the efficient equipment is assumed to be a standard replacement gasket with the same profile and material composition as the original. The fit must be tight and seal properly upon installation with no visible gaps or tears.

DEFINITION OF BASELINE EQUIPMENT

In order for this characterization to apply, the baseline equipment is assumed to be a worn refrigeration gasket with visible damage that is allowing air to enter the unit with the door closed.

DEEMED LIFETIME OF EFFICIENT EQUIPMENT

The expected measure life is 3 years¹⁴⁹²

DEEMED MEASURE COST

Measure costs are based on values from a door gasket measure maintained by the RTF (Regional Technical Forum)¹⁴⁹³. Original measure costs were adjusted for inflation from 2006 to 2024¹⁴⁹⁴.

Annual Savings	Cost/Door
Reach-In Cooler	\$126
Reach-In Freezer	\$156
Walk-In Cooler	\$118
Walk -In Freezer	\$177

LOADSHAPE

Loadshape C22 - Commercial Refrigeration

COINCIDENCE FACTOR

This measure has deemed kW savings therefore a coincidence factor does not apply.

Algorithm

¹⁴⁹² California Public Utilities Commission Database for Energy Efficient Resources (DEER) CPUC Support Table (2020) – Effective Useful Life and Remaining Useful Life. <https://www.caetrm.com/cpuc/table/effusefullife/>

¹⁴⁹³ Database for UES measures, Regional Technical Forum. Door Gasket Replacement, Version 1.5. December 2016 <https://rtf.nwcouncil.org/measure/door-gasket-replacement/>

¹⁴⁹⁴ U.S. Bureau of Labor Statistics - CPI Inflation Calculator <https://data.bls.gov/cgi-bin/cpicalc.pl>

CALCULATION OF ENERGY SAVINGS

Savings calculations are based on values from a door gasket replacement measure maintained by the RTF (Regional Technical Forum).¹⁴⁹⁵

ELECTRIC ENERGY SAVINGS

$$\Delta kWh = \Delta kWh_{Door} * Doors$$

Where:

ΔkWh_{Door} = Annual kWh savings per door from the table below

Annual Savings	ΔkWh_{Door}
Reach-In Cooler	248
Reach-In Freezer	243
Walk-In Cooler	204
Walk -In Freezer	347

Doors = Number of doors receiving new door gaskets

For example, a bank of 10 reach-in cooler doors have their old gaskets replaced with tight fitting and properly sealed new gaskets and would annually save:

$$\begin{aligned} \Delta kWh &= 248 * 10 \\ &= 2,480 \text{ kWh} \end{aligned}$$

SUMMER COINCIDENT PEAK DEMAND SAVINGS

$$\Delta kW = \Delta kW_{Door} * Doors$$

Where:

ΔkW_{Door} = Annual kW savings per door from the table below

Annual Savings	ΔkW_{Door}
Reach-In Cooler	.032
Reach-In Freezer	.032
Walk-In Cooler	.027
Walk -In Freezer	.045

FOSSIL FUEL SAVINGS

There are no expected fossil fuel gas savings for this measure.

WATER IMPACT DESCRIPTIONS AND CALCULATION

N/A

DEEMED O&M COST ADJUSTMENT CALCULATION

N/A

¹⁴⁹⁵ Database for UES measures, Regional Technical Forum. Door Gasket Replacement, Version 1.5. December 2016
<https://rtf.nwncouncil.org/measure/door-gasket-replacement/>

MEASURE CODE: CI-RFG-DGS-V01-250101

REVIEW DEADLINE: 1/1/2027

4.7. Compressed Air End Use

4.7.1 VSD Air Compressor

DESCRIPTION

This measure relates to the installation of an air compressor with a variable frequency drive, load/no-load controls or variable displacement control. Baseline compressors choke off the inlet air to modulate the compressor output, which is not efficient. Efficient compressors use a variable speed drive on the motor to match output to the load. Savings are calculated using representative baseline and efficient demand numbers for compressor capacities according to the facility's load shape, and the number of hours the compressor runs at that capacity. Demand curves are as per DOE data for a Variable Speed compressor versus a Modulating compressor. This measure applies only to an individual compressor ≤ 200 hp. Only one compressor per compressed air distribution system is eligible.

This measure was developed to be applicable to the following program types: TOS.

If applied to other program types, the measure savings should be verified.

DEFINITION OF EFFICIENT EQUIPMENT

The high efficiency equipment is a compressor ≤ 200 hp with variable speed control.

DEFINITION OF BASELINE EQUIPMENT

The baseline equipment is either an oil-flooded compressor ≤ 200 hp with inlet modulating with blowdown or load/no-load controls.

DEEMED LIFETIME OF EFFICIENT EQUIPMENT

13 years¹⁴⁹⁶

DEEMED MEASURE COST

$$\text{IncrementalCost (\$)} = ((127 \times \text{hp}_{\text{compressor}}) + 1,446) \times 1.24^{1497}$$

Where:

127 and 1,446¹⁴⁹⁸ = compressor motor nominal hp to incremental cost conversion factor and offset

$\text{hp}_{\text{compressor}}$ = compressor motor nominal

DEEMED O&M COST ADJUSTMENTS

N/A

LOADSHAPE

Loadshape C35 - Industrial Process

COINCIDENCE FACTOR

The summer peak coincidence factor for this measure is dependent on the industrial shift and corresponding hours of operation. Values are provided for each shift type in the variable definition section.

¹⁴⁹⁶ Department of Energy Technical Support Document.

¹⁴⁹⁷ Adjustment for inflation since incremental cost study is in \$2008. The U.S. Bureau of Labor Statistic CPI Inflation Calculator was used to adjust \$2008 (January) to \$2021 (January). The resulting factor was 1.24. This adjustment was evaluated against current pricing of compressors (2021) and found to be a reasonable and appropriate.

¹⁴⁹⁸ Conversion factor and offset based on a linear regression analysis of the relationship between air compressor motor nominal horsepower and incremental cost, as sourced from the Efficiency Vermont Technical Reference Manual (TRM). Several Vermont vendors were surveyed to determine the cost of equipment.

Algorithm

CALCULATION OF SAVINGS

ELECTRIC ENERGY SAVINGS

$$\Delta kWh = 0.9 \times hp_{\text{compressor}} \times \text{HOURS} \times (CF_b - CF_e)$$

Where:

- ΔkWh = gross customer annual kWh savings for the measure
- $hp_{\text{compressor}}$ = compressor motor nominal hp
- 0.9^{1499} = compressor motor nominal hp to full load kW conversion factor
- HOURS = compressor total hours of operation below depending on shift

Shift	Hours	Description
Single shift (8/5)	1,976	7 AM – 3 PM, weekdays, minus some holidays and scheduled down time
2-shift (16/5)	3,952	7AM – 11 PM, weekdays, minus some holidays and scheduled down time
3-shift (24/5)	5,928	24 hours per day, weekdays, minus some holidays and scheduled down time
4-shift (24/7)	8,320	24 hours per day, 7 days a week minus some holidays and scheduled down time
Unknown / Weighted average ¹⁵⁰⁰	5,702	

CF_b = baseline compressor factor¹⁵⁰¹

Baseline Compressor	Compressor Factor (≤ 40 hp) ¹⁵⁰²	Compressor Factor (50 – 200 hp) ¹⁵⁰³
Modulating w/ Blowdown	0.890	0.863
Load/No-Load w/ 1 Gallon/CFM	0.909	0.887
Load/No-Load w/ 3 Gallon/CFM	0.831	0.811
Load/No-Load w/ 5 Gallon/CFM	0.806	0.786

¹⁴⁹⁹ Conversion factor based on Survey of CAGI data sheets from 200 compressors. See “IL TRM VSD Air Compressor – Supporting Information.xls” for more information.

¹⁵⁰⁰ Weighting of 16% single shift, 23% two shift, 25% three shift and 36% continual based on DOE evaluation of the Compressed Air Challenge, section 2.1.5 Facility Operating Schedules.

¹⁵⁰¹ Compressor factors were developed using DOE part load data for different compressor control types as well as load profiles from 50 facilities employing air compressors less than or equal to 40 hp, as sourced from the Efficiency Vermont TRM. (The “variable speed drive” compressor factor has been adjusted up from the 0.675 presented in the analysis to 0.705 to account for the additional power draw of the VSD).

¹⁵⁰² Compressor factors were developed using DOE part load data for different compressor control types as well as load profiles from 50 facilities employing air compressors less than or equal to 40 hp, as sourced from the Efficiency Vermont TRM. (The “variable speed drive” compressor factor has been adjusted up from the 0.675 presented in the analysis to 0.705 to account for the additional power draw of the VSD). See “IL TRM VSD Air Compressor – Supporting Information.xls” for more information.

¹⁵⁰³ Compressor factors for this size range were developed using DOE part-load data for different compressor control types as well as load profiles from 45 compressors and 20 facilities. This data comes from ComEd Custom and Industrial Systems programs. The compressors were filtered to reflect only rotary screw compressors, between 50 and 200 hp, and operating a minimum of 4 hour per day. Additionally, compressors with clear and consistent baseload profiles were excluded from this analysis. See “IL TRM VSD Air Compressor – Supporting Information.xls” for more information.

CF_e = efficient compressor
 =0.705 for units ≤ 40 hp¹⁵⁰⁴
 = 0.658 for units 50 – 200 hp

For example, a VSD compressor with 10 hp operating in a 1-shift facility would save

ΔkWh = 0.9 x 10 x 1,976 x (0.890 – 0.705)
 = 3,290 kWh

SUMMER COINCIDENT PEAK DEMAND SAVINGS

ΔkW = ΔkWh / HOURS * CF

Where:

CF = Summer peak coincidence factor for this measure

Shift	Coincidence Factor
Single shift (8/5)	0.59
2-shift (16/5)	0.95
3-shift (24/5)	0.95
4-shift (24/7)	0.95
Unknown / Weighted average ¹⁵⁰⁶	0.89

For example, a VSD compressor with 10 HP operating in a 1 shift facility would save

ΔkW = 3,290/1,976*0.59
 = 0.98 kW

FOSSIL FUEL SAVINGS

N/A

WATER IMPACT DESCRIPTIONS AND CALCULATION

N/A

DEEMED O&M COST ADJUSTMENT CALCULATION

N/A

MEASURE CODE: CI-CPA-VSDA-V04-220101

REVIEW DEADLINE: 1/1/2027

¹⁵⁰⁴ Compressor factors were developed using DOE part load data for different compressor control types as well as load profiles from 50 facilities employing air compressors less than or equal to 40 hp, as sourced from the Efficiency Vermont TRM. (The “variable speed drive” compressor factor has been adjusted up from the 0.675 presented in the analysis to 0.705 to account for the additional power draw of the VSD). See “IL TRM VSD Air Compressor – Supporting Information.xls” for more information.

¹⁵⁰⁵ Compressor factors for this size range were developed using DOE part-load data for different compressor control types as well as load profiles from 45 compressors and 20 facilities. This data comes from ComEd Custom and Industrial Systems programs. The compressors were filtered to reflect only rotary screw compressors, between 50 and 200 hp, and operating a minimum of 4 hour per day. Additionally, compressors with clear and consistent baseload profiles were excluded from this analysis. See “IL TRM VSD Air Compressor – Supporting Information.xls” for more information.

¹⁵⁰⁶ Ibid.

4.7.2 Compressed Air Low Pressure Drop Filters

DESCRIPTION

Low pressure drop filters remove solids and aerosols from compressed air systems with a longer life and lower pressure drop than standard coalescing filters, resulting in the ability to lower a compressed air systems pressure setpoints. This reduces the compressor work required resulting in energy savings.

This measure was developed to be applicable to the following program types: RF. If applied to other program types, the measure savings should be verified.

DEFINITION OF EFFICIENT EQUIPMENT

The efficient condition is a low pressure drop filter with pressure drop not exceeding 1 psid when new and 3 psid at element change.

DEFINITION OF BASELINE EQUIPMENT

The baseline condition is a standard coalescing filter with a pressure drop of 3 psid when new and 5 psid or more at element change

DEEMED LIFETIME OF EFFICIENT EQUIPMENT

10 years¹⁵⁰⁷

DEEMED MEASURE COST

The incremental cost for this measure is estimated to be \$1,000 Incremental cost per filter.¹⁵⁰⁸

LOADSHAPE

Loadshape C35 - Industrial Process

COINCIDENCE FACTOR

The summer peak coincidence factor for this measure is dependent on the industrial shift and corresponding hours of operation. Values are provided for each shift type in the variable definition section.

Algorithm

CALCULATION OF SAVINGS

ELECTRIC ENERGY SAVINGS

$$\Delta kWh = (kW_{\text{typical}} \times \Delta P \times SF \times \text{Hours} / hp_{\text{typical}}) \times hp_{\text{real}}$$

Where:

kW_{typical} = Adjusted compressor power (kW) based on typical compressor loading and operating profile. Use actual compressor control type if known:

¹⁵⁰⁷ Based on survey of manufacturer claims (Zeks, Van Air, Quincy), as recommended in Navigant 'ComEd Effective Useful Life Research Report', May 2018.

¹⁵⁰⁸ Incremental cost research found in LPDF Costs. xlsx.

Compressor kW_{typical}

Control Type	kW _{typical} ¹⁵⁰⁹
Reciprocating - On/off Control	70.2
Reciprocating - Load/Unload	74.8
Screw - Load/Unload	82.3
Screw - Inlet Modulation	82.5
Screw - Inlet Modulation w/ Unloading	82.5
Screw - Variable Displacement	73.2
Screw - VFD	70.8

= If the actual compressor control type is not known, use a weighted average based on the following market assumptions:

Control Type	Share %	kW _{typical} ¹⁵¹⁰
Market share estimation for load/unload control compressors	40%	74.8
Market share estimation for modulation w/unloading control compressors	40%	82.5
Market share estimation for variable displacement control compressors	20%	73.2
Weight average	-	77.6

ΔP = Reduction in pressure differential across the filter (psi)

=2 psi¹⁵¹¹

SF =1% reduction in power per 2 psi reduction in system pressure is equal to 0.5% reduction per 1 psi, or a Savings Factor of 0.005¹⁵¹²

Hours = Compressor hours of operation below depending on shift

Shift	Hours	Description
Single shift (8/5)	1,976	7 AM – 3 PM, weekdays, minus three-weekday holidays and 10 days of scheduled down time
2-shift (16/5)	3,952	7AM – 11 PM, weekdays, minus three-weekday holidays and 10 days of scheduled down time
3-shift (24/5)	5,928	24 hours per day, weekdays, minus three-weekday holidays and 10 days of scheduled down time
4-shift (24/7)	8,320	24 hours per day, 7 days a week minus three-week day holidays and 10 days of scheduled down time
Unknown / Weighted average ¹⁵¹³	5,702	

hp_{typical} = Nominal hp for typical compressor = 100 hp¹⁵¹⁴

¹⁵⁰⁹ See “Industrial System Standard Deemed Saving Analysis.xls”.

¹⁵¹⁰ See “Industrial System Standard Deemed Saving Analysis.xls”.

¹⁵¹¹ Assumed pressure will be reduced from a roughly 3 psi pressure drop through a filter to less than 1 psi, for a 2 psi savings

¹⁵¹² “Optimizing Pneumatic Systems for Extra Savings,” Compressed Air Best Practices, DOE Compressed Air Challenge, 2010.

¹⁵¹³ Weighting of 16% single shift, 23% two shift, 25% three shift and 36% continual based on DOE evaluation of the Compressed Air Challenge, section 2.1.5 Facility Operating Schedules.

¹⁵¹⁴ Industrial System Standard Deemed Saving Analysis.xls

hp_{real} = Total hp of real compressors distributing air through filter. This should include the total horsepower of the compressors that normally run through the filter, but not backup compressors.

SUMMER COINCIDENT PEAK DEMAND SAVINGS

$$\Delta kW = \Delta kWh / \text{Hours} * CF$$

Where:

CF = Summer peak coincidence factor for this measure

Shift	Coincidence Factor
Single shift (8/5)	0.59
2-shift (16/5)	0.95
3-shift (24/5)	0.95
4-shift (24/7)	0.95
Unknown / Weighted average ¹⁵¹⁵	0.89

FOSSIL FUEL SAVINGS

N/A

WATER IMPACT DESCRIPTIONS AND CALCULATION

N/A

DEEMED O&M COST ADJUSTMENT CALCULATION

N/A

MEASURE CODE: CI-CPA-LPDF-V04-220101

REVIEW DEADLINE: 1/1/2027

¹⁵¹⁵ Weighting of 16% single shift, 23% two shift, 25% three shift and 36% continual based on DOE evaluation of the Compressed Air Challenge, section 2.1.5 Facility Operating Schedules.

4.7.3 Compressed Air No-Loss Condensate Drains

DESCRIPTION

No-loss condensate drains remove condensate as needed without venting compressed air, resulting in less air demand and consequently better efficiency. Replacement or upgrades of existing no-loss drains are not eligible for the incentive.

This measure was developed to be applicable to the following program types: RF. If applied to other program types, the measure savings should be verified.

DEFINITION OF EFFICIENT EQUIPMENT

The efficient condition is installation of no-loss condensate drains.

DEFINITION OF BASELINE EQUIPMENT

The baseline condition is installation of standard condensate drains (open valve, timer, or both)

DEEMED LIFETIME OF EFFICIENT EQUIPMENT

The expected measure life is 13 years.¹⁵¹⁶

DEEMED MEASURE COST

The average equipment cost per drain is \$194 with an installation labor cost of \$50 for a total incremental cost \$244 per drain.¹⁵¹⁷

LOADSHAPE

Loadshape C35 - Industrial Process

COINCIDENCE FACTOR

The coincidence factor equals 0.80¹⁵¹⁸

Algorithm

CALCULATION OF SAVINGS

ELECTRIC ENERGY SAVINGS

$$\Delta kWh = CFM_{reduced} \times kW_{CFM} \times \text{Hours}$$

Where:

$$CFM_{reduced} = \text{Reduced air consumption (CFM) per drain}$$

$$= 3 \text{ CFM}^{1519}$$

$$kW_{CFM} = \text{System power reduction per reduced air demand (kW/CFM) depending on the type of compressor control:}$$

¹⁵¹⁶ Measure Life Study prepared for The Massachusetts Joint Utilities, Energy & Resource Solutions, 2005

¹⁵¹⁷ Based on empirical project data from ComEd Comprehensive Compressed Air Study program and VEIC review of pricing data found in CAS Cost Data.xlsx.

¹⁵¹⁸ DMI (2006). Impact Evaluation of 2004 Compressed Air Prescriptive Rebates. Prepared for National Grid; results analyzed in RLW Analytics (2006). Sample Design and Impact Evaluation Analysis for Prescriptive Compressed Air Measures in the Energy Initiative and Design 2000 Programs. Prepared for National Grid.

¹⁵¹⁹ Reduced CFM consumption is based on a timer drain opening for 10 seconds every 300 seconds as the baseline. See "Industrial System Standard Deemed Saving Analysis.xls".

System Power Reduction per Reduced Air Demand¹⁵²⁰

Control Type	kW / CFM
Reciprocating - On/off Control	0.184
Reciprocating - Load/Unload	0.136
Screw - Load/Unload	0.152
Screw - Inlet Modulation	0.055
Screw - Inlet Modulation w/ Unloading	0.055
Screw - Variable Displacement	0.153
Screw - VFD	0.178

Or if compressor control type is unknown, then a weighted average based on market share can be used:¹⁵²¹

Control Type	Share %	kW / CFM
Market share estimation for load/unload control compressors	40%	0.136
Market share estimation for modulation w/unloading control compressors	40%	0.055
Market share estimation for variable displacement control compressors	20%	0.153
Weighted Average		0.107

Hours = Compressed air system pressurized hours
 =6136 hours¹⁵²²

SUMMER COINCIDENT PEAK DEMAND SAVINGS

$\Delta kW = \Delta kWh / HOURS * CF$

Where:

CF = Summer peak coincidence factor for this measure
 = 0.80¹⁵²³

FOSSIL FUEL SAVINGS

N/A

WATER IMPACT DESCRIPTIONS AND CALCULATION

N/A

DEEMED O&M COST ADJUSTMENT CALCULATION

N/A

¹⁵²⁰ Calculated based on the type of compressor control. This assumes the compressor will be between 40% and 100% capacity before and after the changes to the system demand. See "Industrial System Standard Deemed Saving Analysis.xls".

¹⁵²¹ Table 8.2.3, Technical Support Document. US Department of Energy

¹⁵²² US DOE, Evaluation of the Compressed Air Challenge® Training Program, Page 19.

¹⁵²³ DMI (2006). Impact Evaluation of 2004 Compressed Air Prescriptive Rebates. Prepared for National Grid; results analyzed in RLW Analytics (2006). Sample Design and Impact Evaluation Analysis for Prescriptive Compressed Air Measures in the Energy Initiative and Design 2000 Programs. Prepared for National Grid.

MEASURE CODE: CI-CPA-NCLD-V04-250101

REVIEW DEADLINE: 1/1/2028

4.7.4 Efficient Compressed Air Nozzles

DESCRIPTION

This measure is for the replacement of a standard air nozzle with a high-efficiency air nozzle used in a compressed air system. High-efficiency air nozzles reduce the amount of air required to blow off parts or for drying. These nozzles utilize the Coandă effect to pull in free air to accomplish tasks with significantly less compressed air. High-efficiency nozzles often replace simple copper tubes. These nozzles have the added benefits of noise reduction and improved safety in systems with greater than 30 psig.

DEFINITION OF EFFICIENT EQUIPMENT

The high-efficiency air nozzle must meet the following specifications:

1. High-efficiency air nozzle must replace continuous open blow-offs.
2. High-efficiency air nozzle must meet SCFM rating at 80psig less than or equal to:

Nozzle Diameter:	1/8"	1/4"	5/16"	1/2"
Max SCFM Rating @ 80psig:	11	29	56	140

3. Manufacturer’s specification sheet of the high-efficiency air nozzle must be provided along with the make and model.

DEFINITION OF BASELINE EQUIPMENT

The baseline condition is a standard air nozzle.

DEEMED LIFETIME OF EFFICIENT EQUIPMENT

The measure life is 15 years.¹⁵²⁴

DEEMED MEASURE COST

The estimated incremental measure costs are presented in the following table.¹⁵²⁵

Nozzle Diameter:	1/8"	1/4"	5/16"	1/2"
Average Incremental Cost:	\$42	\$57	\$87	\$121

LOADSHAPE

Loadshape C35 - Industrial Process

COINCIDENCE FACTOR

The summer peak coincidence factor for this measure is dependent on the industrial shift and corresponding hours of operation. Values are provided for each shift type in the variable definition section.

Algorithm

CALCULATION OF ENERGY SAVINGS

ELECTRIC ENERGY SAVINGS

$$\Delta kWh = (SCFM * SCFM\%Reduced) * kW/CFM * \%USE * Hours$$

¹⁵²⁴ PA Consulting Group (2009). Business Programs: Measure Life Study. Prepared for State of Wisconsin Public Service Commission.

¹⁵²⁵ Costs are from EXAIR’s website and are an average of nozzles that meet the flow requirements. Models include Atto Super, Pico Super, Nano Super, Micro Super, Mini Super, Super and Large Super nozzles. Accessed March 20, 2014.

Where:

SCFM = Air flow through standard nozzle. Use actual rated flow at 80 psi if known. If unknown, the table below includes the CFM by orifice diameter.^{1526, 1527}

Orifice Diameter	SCFM
1/8"	21
1/4"	58
5/16"	113
1/2"	280

SCFM%Reduced = Percent in reduction of air loss per nozzle. Estimated at 50%.¹⁵²⁸

kW/CFM = System power reduction per air demand (kW/CFM) depending on the type of air compressor found in table below:¹⁵²⁹

Air Compressor Type	kW/CFM
Reciprocating – On/off Control	0.18
Reciprocating – Load/Unload	0.14
Screw – Load/Unload	0.15
Screw – Inlet Modulation	0.06
Screw – Inlet Modulation w/ Unloading	0.06
Screw – Variable Displacement	0.15
Screw - VFD	0.18

%USE = Percent of the compressor’s total operating hours that the nozzle is in use.

= Custom. If unknown assume 5%.¹⁵³⁰

Hours = Compressed air system pressurized hours.

= Use actual hours if known. Otherwise assume values in table below:

Shift	Hours
Single Shift	1,976
Two Shifts	3,952
Three Shifts	5,928
Four Shifts or Continual Operation	8,320
Unknown / Weighted average ¹⁵³¹	5,702

¹⁵²⁶ Review of manufacturer’s information.

¹⁵²⁷ Technical Reference Manual (TRM) for Ohio Senate Bill 221 “Energy Efficiency and Conservation Program” and 09-512-GE-UNC, October 15, 2009. Pages 170-171.

¹⁵²⁸ Conservative estimate based on average values provided by the Compressed Air Challenge Training Program, Machinery’s Handbook 25th Edition, and manufacturers’ catalog.

¹⁵²⁹ Calculated based on the type of compressor control. This assumes the compressor will be between 40% and 100% capacity before and after the changes to the system demand. See “Industrial System Standard Deemed Saving Analysis.xls”.

¹⁵³⁰ Assumes 50% handheld air guns and 50% stationary air nozzles. Manual air guns tend to be used less than stationary air nozzles, and a conservative estimate of 1 second of blow-off per minute of compressor run time is assumed. Stationary air nozzles are commonly more wasteful as they are often mounted on machine tools and can be manually operated resulting in the possibility of a long term open blow situation. An assumption of 5 seconds of blow-off per minute of compressor run time is used.

¹⁵³¹ Weighting of 16% single shift, 23% two shift, 25% three shift and 36% continual based on DOE evaluation of the Compressed Air Challenge, section 2.1.5 Facility Operating Schedules.

For example, a ¼” diameter efficient air nozzle on a screw – VFD system, running on a three-shift schedule would save the following:

$$\begin{aligned} \Delta kWh &= (SCFM * SCFM\%Reduced) * kW/CFM * \%USE * Hours \\ &= (58 * 50\%) * 0.18 * 5\% * 5,928 \\ &= 1,547.2 kWh \end{aligned}$$

SUMMER COINCIDENT PEAK DEMAND SAVINGS

$$\Delta kW = \Delta kWh / Hours * CF$$

Where:

- ΔkWh = As calculated above.
- CF = Summer peak coincidence factor

Shift	Coincidence Factor
Single Shift	0.59
Two Shifts	0.95
Three Shifts	0.95
Four Shifts or Continual Operation	0.95
Unknown / Weighted average ¹⁵³²	0.89

For example, a ¼” diameter efficient air nozzle on a screw – VFD system, running on a three-shift schedule would save the following:

$$\begin{aligned} \Delta kW &= \Delta kWh / Hours * CF \\ &= 1,547.2 / 5,928 * 0.95 \\ &= 0.25 kW \end{aligned}$$

FOSSIL FUEL SAVINGS

N/A

WATER IMPACT DESCRIPTIONS AND CALCULATION

N/A

DEEMED O&M COST ADJUSTMENT CALCULATION

N/A

MEASURE CODE CI-CPA-CNOZ-V04-250101

REVIEW DEADLINE: 1/1/2027

¹⁵³² Ibid.

4.7.5 Efficient Refrigerated Compressed Air Dryer

DESCRIPTION

An air dryer is an essential component in a compressed air system that prevents condensate from being deposited in the compressed air supply lines of a facility. If warm saturated compressed air is supplied directly to the plant, excess condensate will form in the compressed air supply lines. Uncontrolled condensate can damage demand-side tools and process equipment. Secondly, in an oil-flooded rotary screw compressor, the residual oil from compression can be carried along the supply lines potentially damaging process equipment. Industries that use compressed air for processes make use of various types of dryers including refrigerated dryers (both cycling and non-cycling). For this measure, three types of refrigerated air dryers will be considered: thermal mass, variable speed, and digital scroll. All these technologies offer better part load performance compared to non-cycling refrigerated dryers, thereby offering energy savings during periods when the dryer is not operating at peak capacity.

This measure was developed to be applicable to the following program types: TOS.

If applied to other program types, the measure savings should be verified.

DEFINITION OF EFFICIENT EQUIPMENT

A new, high efficiency thermal mass dryer, variable speed dryer, or digital scroll dryer.

DEFINITION OF BASELINE EQUIPMENT

A standard non-cycling refrigerated compressed air dryer of comparable capacity.

DEEMED LIFETIME OF EFFICIENT EQUIPMENT

The measure life is 13 years.¹⁵³³

DEEMED MEASURE COST

The incremental capital cost for this measure is \$6 per CFM.¹⁵³⁴

LOADSHAPE

Loadshape C35 – Industrial Process

COINCIDENCE FACTOR

The summer peak coincidence factor for this measure is dependent on the industrial shift and corresponding hours of operation. Values are provided for each shift type in the variable definition section.

Algorithm

CALCULATION OF SAVINGS

ELECTRIC ENERGY SAVINGS

$$\Delta kWh = P_s * (EC50_{baseline} - EC50_{efficient}) * HOURS * CFM$$

Where:

$$P_s = \text{Full flow specific power of the dryer}$$

$$= 0.007 \text{ kW/CFM}^{1535} \text{ (for both baseline and efficient equipment)}$$

¹⁵³³ As recommended in Navigant 'ComEd Effective Useful Life Research Report', May 2018.

¹⁵³⁴ Analysis of material cost between cycling and non-cycling dryers according to online prices from Grainger. Cost provided is the average incremental cost when comparing non-cycling and cycling dryers of the same CFM capacity.

¹⁵³⁵ Compressed Air Challenge: Compressed Air Best Practice; "Cycling Air Dryers – Are Savings Significant?" Fox, Timothy J. and Marshall, Ron.

EC50_{baseline} = Energy consumption ratio of baseline dryer at 50%¹⁵³⁶ inlet load capacity as compared to fully loaded operating conditions.¹⁵³⁷
 = 0.843

ECF50_{efficient} = Energy consumption ratio of efficient dryer at 50% inlet load capacity as compared to fully loaded operating conditions.
 = Dependent on efficient dryer type, refer to the following table:¹⁵³⁸

Dryer Type	EC50 _{efficient}
Thermal-Mass	0.729
VSD	0.501
Digital Scroll	0.551

HOURS = Compressed air system pressurized hours, depending on shift. If unknown, use weighted average. This value is the weighted average of facility owner responses from the DOE evaluation of the Compressed Air Challenge. Facility owners with compressed air systems were surveyed detailing the number of shifts their facilities operated.

Shift	Shift	Hours	Distribution of Facilities by Hours of Operation ¹⁵³⁹	Weighted Hours
Single Shift	7 AM – 3 PM, weekdays, minus some holidays and scheduled down time	1,976	16%	316
Two Shift	7AM – 11 PM, weekdays, minus some holidays and scheduled down time	3,952	23%	909
Three Shift	24 hours per day, weekdays, minus some holidays and scheduled down time	5,928	25%	1,482
Four Shifts or Continual Operation	24 hours per day, 7 days a week minus some holidays and scheduled down time	8,320	36%	2,995
			Total Weighted Average:	5,702

CFM = Cubic feet per minute, rated capacity of refrigerated dryer
 = Assume 100% of actual rated capacity.

SUMMER COINCIDENT PEAK DEMAND SAVINGS

$$\Delta kW = \Delta kWh / \text{HOURS} * CF$$

Where:

CF = Summer peak coincidence factor, depending on shift. If unknown, use weighted average.

Shift	Coincidence Factor
Single Shift	0.59

¹⁵³⁶ Engineering judgement, based on the assumption that on average, compressed air systems will operate at 50% capacity.
¹⁵³⁷ Compressed Air Challenge: Compressed Air Best Practice; “Cycling Air Dryers – Are Savings Significant?” Fox, Timothy J. and Marshall, Ron.
¹⁵³⁸ Compressed Air Challenge: Compressed Air Best Practice; “Cycling Air Dryers – Are Savings Significant?” Fox, Timothy J. and Marshall, Ron.
¹⁵³⁹ DOE evaluation of the Compressed Air Challenge, section 2.1.5 Facility Operating Schedules.

Two Shifts	0.95
Three Shifts	0.95
Four Shifts or Continual Operation	0.95
Unknown / Weighted average ¹⁵⁴⁰	0.89

FOSSIL FUEL SAVINGS

N/A

WATER IMPACT DESCRIPTIONS AND CALCULATION

N/A

DEEMED O&M COST ADJUSTMENT CALCULATION

N/A

MEASURE CODE: CI-CPA-CADR-V03-240101

REVIEW DEADLINE: 1/1/2028

¹⁵⁴⁰ Weighting of 16% single shift, 23% two shift, 25% three shift and 36% continual based on DOE evaluation of the Compressed Air Challenge, section 2.1.5 Facility Operating Schedules.

4.7.6 Vortex Tube Thermostat - Provisional Measure – Retired 12/31/2023, Removed in v12

4.7.7 Efficient Desiccant Compressed Air Dryer

DESCRIPTION

Compressed air is dried to reduce or eliminate condensation that can harm the compressed air system or end use equipment. For applications that require air to be dried below a dew point of 35°F,¹⁵⁴¹ regenerative desiccant air dryers are typically used. Typically, regenerative desiccant dryers achieve pressure dew points as low as -40°F.

Regenerative desiccant dryers generally consist of two towers (or vertical tanks) filled with porous desiccant media. “Wet” compressed air flows through one tower, exiting as dried compressed air, while the other tower is dried out (or regenerated). This dryer alternates this process between towers to prevent compressed air flowing through saturated towers and damaging downstream equipment. The means of regeneration distinguishes the different types of regenerative dryer.

Heatless Desiccant Dryer: Uses compressed air (“purge air”) to dry out the regenerating tower. The amount of purge air is typically between 15-20% of the dryer’s rate flow (CFM), regardless of the flow rate that the compressor is supplying.¹⁵⁴² This type of dryer alternates tower regeneration approximately every 5 minutes.¹⁵⁴³

Heated Desiccant Dryer: Uses a combination of compressed purge air and heat for regeneration. The amount of purge air is typically 5-10% of the dryer’s rate flow (CFM), regardless of the flow rate that the compressor is supplying.¹⁵⁴⁴ This type of dryer alternates tower regeneration approximately every 8 hours.¹⁵⁴⁵

Externally Heated Blower Purge Dryer: Uses an external blower and heat source for regeneration. This type of dryer requires a small amount (2%) of purge air or ambient air to cool the tower after heating. This type of dryer alternates tower regeneration approximately every 8 hours.¹⁵⁴⁶ There is also a type of blower purge dryer called a zero-purge dryer that eliminates all compressed purge air.

The energy use of these dryers is primarily due to regeneration of the desiccant. Standard dryers come equipped with a fixed, timer regeneration control. However, the actual load on the dryer is variable. Optional dew point demand controls (DPDC) adjust the amount of regeneration to the moisture load on the dryer, reducing unnecessary purge energy.

This measure was developed to be applicable to the following program types: TOS, NC, ER.

DEFINITION OF EFFICIENT EQUIPMENT

The efficient equipment is heated or externally heated by a blower purge desiccant dryer without dew point demand controls. Dryers installed on inlet modulation compressors do not qualify for this measure.

¹⁵⁴¹ The dew point limitation of the most common refrigerant-type air dryer. Improving Compressed Air System Performance: A Sourcebook for Industry, US Department of Energy. Page 48.

<https://www.energy.gov/sites/prod/files/2016/03/f30/Improving%20Compressed%20Air%20Sourcebook%20version%203.pdf>

¹⁵⁴² Lessons Learned: Saving Energy Costs with Heated Blower Purge Desiccant Dryers, Marshall, Ron.

<https://airbestpractices.com/system-assessments/air-treatment2/lessons-learned-saving-energy-costs-heated-blower-desiccant-dry-0>

¹⁵⁴³ Regenerative Desiccant Compressed Air Dryers. White, Donald. <https://airbestpractices.com/technology/air-treatment2/regenerative-desiccant-compressed-air-dryers>

¹⁵⁴⁴ Types of Compressed Air Dryers 2: Refrigerant and Regenerative Desiccant, Compressed Air and Gas Institute (CAGI). <https://airbestpractices.com/technology/air-treatment/n2/types-compressed-air-dryers-refrigerant-and-regenerative-desiccant>

¹⁵⁴⁵ Regenerative Desiccant Compressed Air Dryers. White, Donald. <https://airbestpractices.com/technology/air-treatment2/regenerative-desiccant-compressed-air-dryers>

¹⁵⁴⁶ Regenerative Desiccant Compressed Air Dryers. White, Donald. <https://airbestpractices.com/technology/air-treatment2/regenerative-desiccant-compressed-air-dryers>

DEFINITION OF BASELINE EQUIPMENT

The baseline equipment is a heatless regenerative desiccant dryer without dew point demand controls.

DEEMED LIFETIME OF EFFICIENT EQUIPMENT

The lifetime of this measure is 15 years.¹⁵⁴⁷

DEEMED MEASURE COST

The incremental equipment cost for heated and blower purge regenerative desiccant dryers is \$3/CFM and \$12/CFM, respectively.¹⁵⁴⁸

LOADSHAPE

Loadshape C35 – Industrial Process

COINCIDENCE FACTOR

The summer peak coincidence factor for this measure is dependent on the industrial shift and corresponding hours of operation. Values are provided for each shift type in the variable definition section.

Algorithm

CALCULATION OF ENERGY SAVINGS

ELECTRIC ENERGY SAVINGS

$$\Delta kWh = CFM_{Dryer} * (P_{Base} - P_{EE} * PRF) * HOU$$

Where:

CFM_{Dryer} = rated capacity of the dryer in cubic feet per minute (CFM)

P_{Base} = power requirement of the baseline heatless regenerative dryer (kW/CFM)
 = PF_{Heatless} * kW_{comp}

PF_{Heatless} = purge flow of heatless model (%)
 = 15%¹⁵⁴⁹

kW_{comp} = system power reduction per reduced air demand (kW/CFM) depending on the type of compressor control.¹⁵⁵⁰ If unknown, assume Screw – Load/Unload.

Air Compressor Type	ΔkW/CFM
Reciprocating – On/off Control	0.18
Reciprocating – Load/Unload	0.14
Screw – Load/Unload	0.15
Screw – Variable Displacement	0.15
Screw - VFD	0.18

¹⁵⁴⁷ Focus on Energy Evaluation Business Programs: Measure Life Study, p. 91-92. PA Consulting Group. August 25, 2009. https://focusonenergy.com/sites/default/files/bpmeasurelifestudyfinal_evaluationreport.pdf

¹⁵⁴⁸ Analysis of equipment cost between heatless, heated, blower purge dryers according to available online pricing. The capacity range considered was 250 – 1,500 CFM. Cost provided is the average incremental cost when comparing heated and blower purge dryers to baseline heatless dryers of the same CFM capacity. See “IL TRM Deissciant Dryers – Supporting Information.xls” file for more detail.

¹⁵⁴⁹ Typical estimates of purge flow for heatless dryers range from 15-20% of dryer rated capacity. 15% was selected as a conservative value.

¹⁵⁵⁰ Consistent with Air Nozzle measure, this assumes the compressor will be between 40% and 100% capacity before and after the changes to the system demand. See “Industrial System Standard Deemed Saving Analysis.xls”.

Note: Dryers installed on inlet modulation compressors do not qualify for this measure.

P_{EE}	= power requirement of the energy efficient (heated or blower purge) regenerative dryer (kW/CFM) = ($PF_{EE} * kW_{comp} + kW_{Heater} + kW_{Blower}$)
PF_{EE}	= purge flow of energy efficient model (%) ¹⁵⁵¹ = 7.5% for heated models = 2% for blower purge models (with compressed air cooling) = 0% for “zero-purge” blower purge models
kW_{Heater}	= average power of heater per CFM of dryer (kW/CFM) ^{1552,1553} = 0.007 kW/CFM for heated models = 0.013 kW/CFM for blower purge models
kW_{Blower}	= average power of blower per CFM of dryer (kW/CFM) ¹⁵⁵⁴ = 0 kW/CFM for heated models = 0.003 kW/CFM for blower purge models
PRF	= purge reduction factor = Assume 50% for heatless desiccant dryers ¹⁵⁵⁵ = Assume 60% for externally heated or heated blower purge desiccant dryers ¹⁵⁵⁶
HOU	= compressor total hours of operation below depending on shift

¹⁵⁵¹ Lessons Learned: Saving Energy Costs with Heated Blower Purge Desiccant Dryers, Marshall, Ron.

<https://airbestpractices.com/system-assessments/air-treatment2/lessons-learned-saving-energy-costs-heated-blower-desiccant-dry-0>

¹⁵⁵² Based on a review of data sheets from six manufacturers. These values reflect average heater kW and not nominal heater kW. The heater operation will vary based on moisture load to the dryer. See “IL TRM Desiccant Dryers – Supporting Information.xls” file for more detail.

¹⁵⁵³ The heater operation will be controlled by temperature to avoid overheating the desiccant media. Lessons Learned: Saving Energy Costs with Heated Blower Purge Desiccant Dryers, Marshall, Ron. <https://airbestpractices.com/system-assessments/air-treatment2/lessons-learned-saving-energy-costs-heated-blower-desiccant-dry-0>

¹⁵⁵⁴ Based on a review of data sheets from six manufacturers. These values reflect average blower kW and not nominal blower kW. The blower operation will in many cases vary based on moisture load to the dryer. See “IL TRM Desiccant Dryers – Supporting Information.xls” file for more detail.

¹⁵⁵⁵ “For heatless desiccant dryers, the reduction in purge tends to be proportional only to the reduction of flow, not the reduction in moisture load due to the lower inlet temperatures.” The 50% value is based on the TRM’s assumption of a 50% dryer load factor used Illinois TRM Measure 4.7.5. Marshall, Ron. Lessons Learned: Saving Energy Costs with Heated Blower Desiccant Dryers. <https://www.airbestpractices.com/system-assessments/air-treatment2/lessons-learned-saving-energy-costs-heated-blower-desiccant-dry-0>

¹⁵⁵⁶ “But for heated style units, the dryer reacts to both reductions. This means some energy is saved due to flow reduction, and additional energy is saved due to the lower moisture load in the cooler inlet air, resulting in more energy savings when compared with heatless styles.” Marshall, Ron. Lessons Learned: Saving Energy Costs with Heated Blower Desiccant Dryers. <https://www.airbestpractices.com/system-assessments/air-treatment2/lessons-learned-saving-energy-costs-heated-blower-desiccant-dry-0>

Shift	Hours
Single Shift	1,976
Two Shifts	3,952
Three Shifts	5,928
Four Shifts or Continual Operation	8,320
Unknown / Weighted average ¹⁵⁵⁷	5,702

SUMMER COINCIDENT PEAK DEMAND SAVINGS

$$\Delta kW_{\text{peak}} = \Delta kWh / \text{HOU} * CF$$

Where:

CF = summer peak coincidence factor

Shift	Coincidence Factor
Single Shift	0.59
Two Shifts	0.95
Three Shifts	0.95
Four Shifts or Continual Operation	0.95
Unknown / Weighted average ¹⁵⁵⁸	0.89

FOSSIL FUEL SAVINGS

N/A

WATER AND OTHER NON-ENERGY IMPACT DESCRIPTIONS AND CALCULATION

N/A

DEEMED O&M COST ADJUSTMENT CALCULATION

N/A

MEASURE CODE CI-CPA-DDRY-V03-240101

REVIEW DEADLINE: 1/1/2028

¹⁵⁵⁷ Weighting of 16% single shift, 23% two shift, 25% three shift and 36% continual based on DOE evaluation of the Compressed Air Challenge, section 2.1.5 Facility Operating Schedules.

¹⁵⁵⁸ Weighting of 16% single shift, 23% two shift, 25% three shift and 36% continual based on DOE evaluation of the Compressed Air Challenge, section 2.1.5 Facility Operating Schedules.

4.7.8 Desiccant Dryer Dew Point Demand Controls

DESCRIPTION

Compressed air is dried to reduce or eliminate condensation that can harm the compressed air system or end use equipment. For applications that require air to be dried below a dew point of 35°F,¹⁵⁵⁹ regenerative desiccant air dryers are typically used. Typically, regenerative desiccant dryers achieve pressure dew points as low as -40°F.

Regenerative desiccant dryers generally consist of two towers (or vertical tanks) filled with porous desiccant media. “Wet” compressed air flows through one tower, exiting as dried compressed air, while the other tower is dried out (or regenerated). This dryer alternates this process between towers to prevent compressed air flowing through saturated towers and damaging downstream equipment. The means of regeneration distinguishes the different types of regenerative dryer.

The energy use of these dryers is primarily due to regeneration of the desiccant. Standard dryers come equipped with a fixed, timer regeneration control. However, the actual load on the dryer is variable. Dew point demand controls (DPDC) adjust the amount of regeneration to the load on the dryer, reducing unnecessary purge energy. DPDC can be retrofit on existing desiccant dryers or integrated in new desiccant dryers.

Heatless Desiccant Dryer: Uses compressed air (“purge air”) to dry out the regenerating tower. The amount of purge air is typically between 15-20% of the dryer’s rate flow (CFM), regardless of the flow rate that the compressor is supplying.¹⁵⁶⁰ This type of dryer alternates tower regeneration approximately every 5 minutes.¹⁵⁶¹

Heated Desiccant Dryer: Uses a combination of compressed purge air and heat for regeneration. The amount of purge air is typically 5-10% of the dryer’s rate flow (CFM), regardless of the flow rate that the compressor is supplying.¹⁵⁶² This type of dryer alternates tower regeneration approximately every 8 hours.¹⁵⁶³

Externally Heated Blower Purge Dryer: Uses an external blower and heat source for regeneration. This type of dryer requires a small amount (2%) of purge air or ambient air to cool the tower after heating. This type of dryer alternates tower regeneration approximately every 8 hours.¹⁵⁶⁴ There is also a type of blower purge dryer called a zero purge dryer that eliminates all compressed purge air.

This measure was developed to be applicable to the following program types: RF

DEFINITION OF EFFICIENT EQUIPMENT

The efficient equipment is a heatless, externally-heated, or blower purge regenerative desiccant dryer with dew point demand controls. The controls should be able to respond to changes in flow and moisture loading. Dryers installed on inlet modulation compressors do not qualify for this measure.

DEFINITION OF BASELINE EQUIPMENT

The baseline equipment is a heatless, externally-heated, or blower purge regenerative desiccant dryer without dew point demand controls.

¹⁵⁵⁹ The dew point limitation of the most common refrigerant-type air dryer. Improving Compressed Air System Performance: A Sourcebook for Industry, US Department of Energy. Page 48.

¹⁵⁶⁰ Lessons Learned: Saving Energy Costs with Heated Blower Purge Desiccant Dryers, Marshall, Ron.

¹⁵⁶¹ Regenerative Desiccant Compressed Air Dryers. White, Donald.

¹⁵⁶² Types of Compressed Air Dryers 2: Refrigerant and Regenerative Desiccant, Compressed Air and Gas Institute (CAGI).

¹⁵⁶³ Regenerative Desiccant Compressed Air Dryers. White, Donald.

¹⁵⁶⁴ Regenerative Desiccant Compressed Air Dryers. White, Donald.

DEEMED LIFETIME OF EFFICIENT EQUIPMENT

The lifetime of this measure is 5 years.¹⁵⁶⁵

DEEMED MEASURE COST

The estimated cost of the controls retrofit is \$4,000.¹⁵⁶⁶

LOADSHAPE

Loadshape C35 – Industrial Process

COINCIDENCE FACTOR

The summer peak coincidence factor for this measure is dependent on the industrial shift and corresponding hours of operation. Values are provided for each shift type in the variable definition section.

Algorithm

CALCULATION OF ENERGY SAVINGS

ELECTRIC ENERGY SAVINGS

$$\Delta kWh = CFM_{Dryer} * (PF * kW_{Comp} + kW_{Heater} + kW_{Blower}) * HOU * PRF$$

Where:

CFM_{Dryer} = rated capacity of the dryer in cubic feet per minute (CFM)

PF = purge flow of desiccant dryer (%)¹⁵⁶⁷

Air Compressor Type	Purge Flow
Heatless	15%
Externally-Heated	7.5%
Blower Purge	2.0%

kW_{Comp} = system power reduction per reduced air demand (kW/CFM) depending on the type of compressor control.¹⁵⁶⁸ If unknown, assume Screw – Load/Unload.

Air Compressor Type	$\Delta kW/CFM$
Reciprocating – On/off Control	0.18
Reciprocating – Load/Unload	0.14
Screw – Load/Unload	0.15
Screw – Variable Displacement	0.15
Screw - VFD	0.18

Note: Dryers installed on inlet modulation compressors do not qualify for this measure.

kW_{Heater} = average power of heater per CFM of dryer (kW/CFM)^{1569,1570}

¹⁵⁶⁵ Since this is a retrofit, the EUL is one-third of the dryer life which is 15 years (TRM 4.7.7). Focus on Energy Evaluation Business Programs: Measure Life Study, p. 91-92. PA Consulting Group. August 25, 2009.

¹⁵⁶⁶ Desiccant Air Dryer Control: Seeing Isn't Always Believing. Marshall, Ron.

¹⁵⁶⁷ Lessons Learned: Saving Energy Costs with Heated Blower Purge Desiccant Dryers, Marshall, Ron.

¹⁵⁶⁸ Consistent with Air Nozzle measure, this assumes the compressor will be between 40% and 100% capacity before and after the changes to the system demand. See "Industrial System Standard Deemed Saving Analysis.xls".

¹⁵⁶⁹ Based on a review of data sheets from six manufacturers. These values reflect average heater kW and not nominal heater kW. The heater operation will vary based on moisture load to the dryer. See "IL TRM Desiccant Dryers – Supporting Information.xls" file for more detail.

¹⁵⁷⁰ The heater operation will be controlled by temperature to avoid overheating the desiccant media. Lessons Learned: Saving Energy Costs with Heated Blower Purge Desiccant Dryers, Marshall, Ron.

- = 0.007 kW/CFM for heated models
- = 0.013 kW/CFM for blower purge models
- kW_{Blower} = average power of blower per CFM of dryer (kW/CFM)¹⁵⁷¹
- = 0.000 kW/CFM for heated models
- = 0.003 kW/CFM for blower purge models
- HOU = compressor total hours of operation below depending on shift

Shift	Hours
Single Shift	1,976
Two Shifts	3,952
Three Shifts	5,928
Four Shifts or Continual Operation	8,320
Unknown / Weighted average ¹⁵⁷²	5,702

- PRF = purge reduction factor
- = Assume 50% for heatless desiccant dryers¹⁵⁷³
- = Assume 60% for externally-heated or heated blower purge desiccant dryers¹⁵⁷⁴

SUMMER COINCIDENT PEAK DEMAND SAVINGS

$$\Delta kW_{peak} = \Delta kWh / HOU * CF$$

Where:

- CF = summer peak coincidence factor

Shift	Coincidence Factor
Single Shift	0.59
Two Shifts	0.95
Three Shifts	0.95
Four Shifts or Continual Operation	0.95
Unknown / Weighted average ¹⁵⁷⁵	0.89

FOSSIL FUEL SAVINGS

N/A

¹⁵⁷¹ Based on a review of data sheets from six manufacturers. These values reflect average blower kW and not nominal blower kW. The blower operation will in many cases vary based on moisture load to the dryer. See “IL TRM Desiccant Dryers – Supporting Information.xls” file for more detail.

¹⁵⁷² Weighting of 16% single shift, 23% two shift, 25% three shift and 36% continual based on DOE evaluation of the Compressed Air Challenge, section 2.1.5 Facility Operating Schedules.

¹⁵⁷³ “For heatless desiccant dryers, the reduction in purge tends to be proportional only to the reduction of flow, not the reduction in moisture load due to the lower inlet temperatures.” The 50% value is based on the TRM’s assumption of a 50% dryer load factor used Illinois TRM Measure 4.7.5. Marshall, Ron. Lessons Learned: Saving Energy Costs with Heated Blower Desiccant Dryers.

¹⁵⁷⁴ “But for heated style units, the dryer reacts to both reductions. This means some energy is saved due to flow reduction, and additional energy is saved due to the lower moisture load in the cooler inlet air, resulting in more energy savings when compared with heatless styles.” Marshall, Ron. Lessons Learned: Saving Energy Costs with Heated Blower Desiccant Dryers.

¹⁵⁷⁵ Weighting of 16% single shift, 23% two shift, 25% three shift and 36% continual based on DOE evaluation of the Compressed Air Challenge, section 2.1.5 Facility Operating Schedules.

WATER AND OTHER NON-ENERGY IMPACT DESCRIPTIONS AND CALCULATION

N/A

DEEMED O&M COST ADJUSTMENT CALCULATION

N/A

MEASURE CODE CI-CPA-DPDC-V02-230101

REVIEW DEADLINE: 1/1/2027

4.7.9 Compressed Air Heat Recovery

DESCRIPTION

Air compressors are inherently inefficient, converting 80 to 93% of the electrical input energy into heat.¹⁵⁷⁶ Recovering this wasted heat for useful purposes is one method for reducing facility-level energy use. Typical air compressor heat recovery involves ducting air-cooled air compressor exhaust for space heat. Recovered heat can also be used for process heating, water heating, and boiler makeup water heating, but this workpaper only addresses the most common scenario.

This measure was developed to be applicable to the following program types: RF, NC. If applied to other program types, the measure savings should be verified.

DEFINITION OF EFFICIENT EQUIPMENT

The efficient equipment is an air-cooled air compressor that is ducted for heat recovery during the heating season. The ducting must include a thermostat that controls the heat recovery based on whether heating is needed.

DEFINITION OF BASELINE EQUIPMENT

The baseline equipment is an air-cooled air compressor whose exhaust is ducted to the outdoors or to a space where heat is not needed (e.g., compressor room, unoccupied space).

DEEMED LIFETIME OF EFFICIENT EQUIPMENT

15 years¹⁵⁷⁷

DEEMED MEASURE COST

\$80/hp¹⁵⁷⁸

LOADSHAPE

N/A

COINCIDENCE FACTOR

N/A

Algorithm

CALCULATION OF ENERGY SAVINGS

ELECTRIC ENERGY SAVINGS

N/A

SUMMER COINCIDENT PEAK DEMAND SAVINGS

N/A

FOSSIL FUEL SAVINGS

$$\Delta\text{therms} = \eta_{\text{HR}} * 2,545 * \text{hp} * \text{PP} * \text{Hours} * \text{CHF} / 100,000 / \eta_{\text{heat}}$$

Where:

¹⁵⁷⁶ Ron Marshall, William Scales, Gary Shafer, Paul Shaw, Paul Sheaffer, Rick Stasyshan, H.P. Improving Compressed Air System Performance: A Sourcebook for Industry v3. United States: N. p., 2016.

¹⁵⁷⁷ The 15-year measure life is based on the value for HVAC controls within the ComEd EUL research. The ductwork has an estimated 20-year measure life but is limited by the mechanical and thermostatic controls.

¹⁵⁷⁸ This estimate is based on three representative projects received through the Nicor Custom Program. The costs in these three projects were \$73/hp, \$76/hp, and \$84/hp.

η_{HR} = Efficiency of heat recovery

= 80%¹⁵⁷⁹

2,545 = Conversion factor, Btu/hp-hr

hp = Nominal horsepower of the compressor

PP = Percent power at average load (% flow or capacity) conditions. See table below.

If average flow is unknown, assume 65%.¹⁵⁸⁰

If compressor type is unknown, assume Load/No-load (1 gal/CFM).

= 93.5%

Avg. % Capacity	On/Off Control	Load/No-Load (1 gal/cfm)	Load/No-Load (10 gal/cfm)	Inlet Valve Modulation (w/o Blowdown)	Inlet Valve Modulation (w/ Blowdown)	Variable Displacement	VSD w/ Unloading	VSD w/ Stopping
0%	0%	27%	27%	71%	26%	25%	12%	0%
10%	10%	32%	35%	74%	40%	34%	20%	12%
20%	20%	63%	42%	76%	54%	44%	28%	24%
30%	30%	74%	52%	79%	62%	52%	36%	33%
40%	40%	81%	60%	82%	82%	61%	45%	41%
50%	50%	87%	68%	86%	86%	63%	53%	53%
60%	60%	92%	76%	88%	88%	69%	60%	60%
65%	65%	94%	80%	90%	90%	73%	66%	66%
70%	70%	95%	83%	92%	92%	77%	71%	71%
80%	80%	98%	89%	94%	94%	85%	80%	80%
90%	90%	100%	96%	97%	97%	91%	89%	89%
100%	100%	100%	100%	100%	100%	100%	100%	100%

Hours = Compressor hours of operation below depending on shift.

= Use actual hours if known, otherwise assume values in table below:

Shift	Hours
Single Shift	1,976
Two Shifts	3,952
Three Shifts	5,928
Four Shifts or Continual Operation	8,320
Unknown / Weighted average ¹⁵⁸¹	5,702

¹⁵⁷⁹ Ron Marshall, William Scales, Gary Shafer, Paul Shaw, Paul Sheaffer, Rick Stasyshan, H.P. Improving Compressed Air System Performance: A Sourcebook for Industry v3. United States: N. p., 2016 (page 14).

¹⁵⁸⁰ The analysis of compressor load factors for the Illinois TRM’s 4.7.1 VSD Air Compressor measure show an average load factor range of 63 – 65%. For more information, please see: “IL TRM VSD Air Compressor – Supporting Information.xls”.

¹⁵⁸¹ Weighting of 16% single shift, 23% two shift, 25% three shift and 36% continual based on DOE evaluation of the Compressed Air Challenge, section 2.1.5 Facility Operating Schedules.

CHF = Climate heating factor. This value represents the amount of time that the facility has a use for space heating. See table below for values.¹⁵⁸²

Zone	Climate Heating Factor
1 - Rockford	58%
2 - Chicago	55%
3 - Springfield	48%
4 - Belleville	49%
5 - Marion	46%

100,000 = Conversion factor, Btu/therm

η_{heat} = Heating system efficiency

= If actual heating system efficiency is unknown, assume 80%¹⁵⁸³

WATER AND OTHER NON-ENERGY IMPACT DESCRIPTIONS AND CALCULATION

N/A

DEEMED O&M COST ADJUSTMENT CALCULATION

N/A

MEASURE CODE CI-CPA-CHR-V02-230101

REVIEW DEADLINE: 1/1/2027

¹⁵⁸² These values reflect a ratio of the hours below a heating balance point over 8,760. The heating balance point is assumed to be 55°F. The data source is TMY3 data. See “Compressed Air Heat Recovery – Supporting Info” file for derivation.

¹⁵⁸³ 80% is the federal minimum efficiency of gas-fired unit heaters. Unit heaters are a common heat source in industrial and manufacturing settings, where compressed air is likely to be in place.

4.7.10 Compressed Air Storage Receiver Tank

DESCRIPTION

Using an air receiver or storage tank will buffer the air demands of the system on the compressor, thus eliminating short cycling. Although a load/no-load compressor unloads in response to lowered demand, it does so over a period of time to prevent lubrication oil from foaming. Therefore, reducing the number of cycles reduces the number of transition times from load to no-load and saves energy.

To qualify for this measure an existing load/no-load compressor with a 1 gal/cfm storage ratio or a modulating w/ blowdown compressor must be replaced with a load/no-load compressor with an improved storage capacity and ratio.

This measure was developed to be applicable to the following program types: RF, NC. If applied to other program types, the measure savings should be verified.

DEFINITION OF EFFICIENT EQUIPMENT

The efficient equipment is an oil-flooded load/no-load compressor with an improved storage capacity and ratio compared to the existing system. The cfm should reflect the rated capacity (in cfm) of all active compressors. If that value cannot be determined, compressor power can be converted to capacity using the rule-of-thumb of 4.5 cfm/hp.¹⁵⁸⁴

DEFINITION OF BASELINE EQUIPMENT

The baseline equipment is an oil-flooded load/no-load compressor with a 1 gal/cfm storage ratio or a modulating w/ blowdown compressor.

DEEMED LIFETIME OF EFFICIENT EQUIPMENT

10 years

DEEMED MEASURE COST

Incremental cost (\$) = 4.67 * (Tank_E – Tank_B)¹⁵⁸⁵

Where:

4.67 = air receiver tank size, in gallons, to equipment cost conversion factor

Tank_E = efficient tank size (gallons)

Tank_B = baseline tank size (gallons)

LOADSHAPE

Loadshape C35 – Industrial Process

COINCIDENCE FACTOR

The summer peak coincidence factor for this measure is dependent on the industrial shift and corresponding hours of operation. Values are provided for each shift type in the variable definition section.

¹⁵⁸⁴ The 4.5 cfm/hp rule of thumb is based on a rotary screw compressor delivering 4 to 5 cfm per 1 hp, "Relationship Between Pressure and Flow", Compressed Air System Best Practices, Industrial Utility Efficiency.

¹⁵⁸⁵ 2018 Vermont PUC: Technical Reference User Manual (TRM) Measure Savings Algorithms and Cost Assumptions

Algorithm

CALCULATION OF ENERGY SAVINGS

ELECTRIC ENERGY SAVINGS

$$\Delta kWh = 0.9 \times hp_{\text{compressor}} \times \text{Hours} \times (CF_b - CF_e)$$

Where:

- ΔkWh = gross customer annual kWh savings for the measure
- $hp_{\text{compressor}}$ = compressor motor nominal hp
- 0.9^{1586} = compressor motor nominal hp to full load kW conversion factor
- Hours = compressor total hours of operation below depending on shift

Shift	Hours	Description
Single shift (8/5)	1,976	7 AM – 3 PM, weekdays, minus some holidays and scheduled down time
2-shift (16/5)	3,952	7AM – 11 PM, weekdays, minus some holidays and scheduled down time
3-shift (24/5)	5,928	24 hours per day, weekdays, minus some holidays and scheduled down time
4-shift (24/7)	8,320	24 hours per day, 7 days a week minus some holidays and scheduled down time
Unknown / Weighted average ¹⁵⁸⁷	5,702	

- CF_b = baseline compressor factor¹⁵⁸⁸
- = See table below for baseline compressor factor. If compressor type is unknown, default to a load/no-load compressor with 1 gallon/cfm for the appropriate-sized compressor.

Baseline Compressor	Compressor Factor (≤ 40 hp) ¹⁵⁸⁹	Compressor Factor (50 – 200 hp) ¹⁵⁹⁰
Modulating w/ blowdown	0.890	0.863
Load/No-Load w/ 1 gallon/cfm	0.909	0.887
Load/No-Load w/ 3 gallon/cfm	0.831	0.811
Load/No-Load w/ 4 gallon/cfm	0.812	0.792
Load/No-Load w/ 5 gallon/cfm	0.806	0.786

¹⁵⁸⁶ Conversion factor based on Survey of CAGI data sheets from 200 compressors. See “IL TRM VSD Air Compressor – Supporting Information.xls” for more information.

¹⁵⁸⁷ Weighting of 16% single shift, 23% two shift, 25% three shift and 36% continual based on DOE evaluation of the Compressed Air Challenge, section 2.1.5 Facility Operating Schedules.

¹⁵⁸⁸ Compressor factors were developed using DOE part load data for different compressor control types as well as load profiles from 50 facilities employing air compressors less than or equal to 40 hp, as sourced from the Efficiency Vermont TRM.

¹⁵⁸⁹ Compressor factors were developed using DOE part load data for different compressor control types as well as load profiles from 50 facilities employing air compressors less than or equal to 40 hp, as sourced from the Efficiency Vermont TRM. See “IL TRM VSD Air Compressor – Supporting Information.xls” for more information.

¹⁵⁹⁰ Compressor factors for this size range were developed using DOE part-load data for different compressor control types as well as load profiles from 45 compressors and 20 facilities. This data comes from ComEd Custom and Industrial Systems programs. The compressors were filtered to reflect only rotary screw compressors, between 50 and 200 hp, and operating a

CF_e = efficient compressor factor
 = See table above for load/no-load compressors with the adequate storage capacity installed. If unknown, default to load/no-load compressors w/ 4 gallons/cfm.

For example, a 1-shift facility with a 100-hp modulating (with blowdown) adds a 2,000-gallon receiver to their compressed air system. This improvement brings the system storage over 4 gallons/cfm.

Capacity Check: = 2,000 gallons / (100 hp * 4.5 cfm/hp)
 = 4.4 gallons/cfm

ΔkWh = 0.9 * 100 * 1,976 * (0.863 – 0.792)
 = 12,627 kWh

SUMMER COINCIDENT PEAK DEMAND SAVINGS

ΔkW = ΔkWh / Hours * CF

Where:

CF = Summer peak coincidence factor for this measure

Shift	Coincidence Factor
1-shift (8/5)	0.59
2-shift (16/5)	0.95
3-shift (24/5)	0.95
4-shift (24/7)	0.95
Unknown / Weighted average ¹⁵⁹¹	0.89

For example, a 1-shift facility with a 100-hp VSD modulating (with blowdown) compressor adds a 2,000-gallon receiver to their compressed air system. This improvement brings the system storage over 4 gallons per cfm.

Capacity Check: = 2,000 gallons / (100 hp * 4.5 cfm/hp)
 = 4.4 gallons per cfm

ΔkW = 12,627 / 1,976 * 0.59
 = 3.77 kW

FOSSIL FUEL SAVINGS

N/A

WATER IMPACT DESCRIPTIONS AND CALCULATION

N/A

minimum of 4 hour per day, Additionally, compressors with clear and consistent baseload profiles were excluded from this analysis. See "IL TRM VSD Air Compressor – Supporting Information.xls" for more information.

¹⁵⁹¹ Weighting of 16% single shift, 23% two shift, 25% three shift and 36% continual based on DOE evaluation of the Compressed Air Challenge, section 2.1.5 Facility Operating Schedules.

DEEMED O&M COST ADJUSTMENT CALCULATION

N/A

MEASURE CODE: CI-CPA-CASRT-V02-230101

REVIEW DEADLINE: 1/1/2027

4.7.11 Reduce Compressed Air Setpoint

DESCRIPTION

This measure characterizes the energy savings associated with reducing the compressed air pressure setpoint. A lower setpoint pressure results in the reduction of work requirements on the compressor resulting in energy savings. The energy savings assumptions are based on compressors operating at 100 psi.

This measure was developed to be applicable to the following program types: RF. If applied to other program types, the measure savings should be verified.

DEFINITION OF EFFICIENT EQUIPMENT

The efficient equipment must meet the following requirements:

- Compressor setpoint must be decreased
- Specification and location of compressor must be known and verifiable

DEFINITION OF BASELINE EQUIPMENT

The baseline equipment is an air compressor with a pressure setpoint higher than necessary (line pressure more than 115% of the highest end use requirement).

DEEMED LIFETIME OF EFFICIENT EQUIPMENT

The expected measure life is 5 years.¹⁵⁹²

DEEMED MEASURE COST

The incremental cost is assumed to be \$0.

LOADSHAPE

Loadshape C35 – Industrial Process

COINCIDENCE FACTOR

The summer peak coincidence factor for this measure is dependent on the industrial shift and corresponding hours of operation. Values are provided for each shift type in the variable definition section.

Algorithm

CALCULATION OF ENERGY SAVINGS

ELECTRIC ENERGY SAVINGS

$$\Delta kWh = (kW_{\text{typical}} * \Delta P * SF * \text{Hours} / hp_{\text{typical}}) * hp_{\text{real}}$$

Where:

- ΔkWh = gross customer annual kWh savings for the measure
- kW_{typical} = adjusted compressor power (kW) based on typical compressor loading and operating profile. Use actual compressor control type if known:

¹⁵⁹² Based on value from ComEd Operational Efficiency CY2018 Impact Evaluation.

Control Type	kW _{typical} ¹⁵⁹³
Reciprocating - On/off Control	70.2
Reciprocating - Load/Unload	74.8
Screw - Load/Unload	82.3
Screw - Inlet Modulation	82.5
Screw - Inlet Modulation w/ Unloading	82.5
Screw - Variable Displacement	73.2
Screw - VFD	70.8

= if the actual compressor control type is not known, use a weighted average based on the following market assumptions:

Control Type	Share %	kW _{typical} ¹⁵⁹⁴
Market share estimation for load/unload control compressors	56%	74.8
Market share estimation for modulation w/unloading control compressors	27%	82.5
Market share estimation for variable displacement control compressors	17%	73.2
Weight average	-	76.6

ΔP = reduction in pressure differential between efficient and base case (psi)

= actual

SF = 1% reduction in power per 2 psi reduction in system pressure is equal to 0.5% reduction per 1 psi, or a Savings Factor of 0.005¹⁵⁹⁵

HOURS = compressor total hours of operation below depending on shift

Shift	Hours	Description
Single shift (8/5)	1,976	7 AM – 3 PM, weekdays, minus some holidays and scheduled down time
2-shift (16/5)	3,952	7AM – 11 PM, weekdays, minus some holidays and scheduled down time
3-shift (24/5)	5,928	24 hours per day, weekdays, minus some holidays and scheduled down time
4-shift (24/7)	8,320	24 hours per day, 7 days a week minus some holidays and scheduled down time
Unknown / Weighted average ¹⁵⁹⁶	5,702	

hp_{typical} = nominal hp for typical compressor

¹⁵⁹³ Consistent with 4.7.2 Compressed Air Low Pressure Drop Filters. See “Industrial System Standard Deemed Saving Analysis.xls”.

¹⁵⁹⁴ Based on Tables 8.2.2 and 8.2.3 from Technical Support Document: Air Compressors. US Department of Energy. May, 2016.

¹⁵⁹⁵ “Optimizing Pneumatic Systems for Extra Savings,” Compressed Air Best Practices, DOE Compressed Air Challenge, 2010.

¹⁵⁹⁶ Weighting of 16% single shift, 23% two shift, 25% three shift and 36% continual based on DOE evaluation of the Compressed Air Challenge, section 2.1.5 Facility Operating Schedules.

$$= 100 \text{ hp}^{1597}$$

hp_{real} = total hp of real compressors distributing air through filter. This should include the total horsepower of the compressors that normally run through the filter, but not backup compressors.

SUMMER COINCIDENT PEAK DEMAND SAVINGS

$$\Delta kW = \Delta kWh / \text{Hours} * CF$$

Where:

CF = Summer peak coincidence factor for this measure

Shift	Coincidence Factor
Single shift (8/5)	0.59
2-shift (16/5)	0.95
3-shift (24/5)	0.95
4-shift (24/7)	0.95
Unknown / Weighted average ¹⁵⁹⁸	0.89

FOSSIL FUEL SAVINGS

N/A

WATER IMPACT DESCRIPTIONS AND CALCULATION

N/A

DEEMED O&M COST ADJUSTMENT CALCULATION

N/A

MEASURE CODE: CI-CPA-RCAS-V02-230101

REVIEW DEADLINE: 1/1/2027

¹⁵⁹⁷ Consistent with 4.7.2 Compressed Air Low Pressure Drop Filters. See “Industrial System Standard Deemed Saving Analysis.xls”.

¹⁵⁹⁸ Weighting of 16% single shift, 23% two shift, 25% three shift and 36% continual based on DOE evaluation of the Compressed Air Challenge, section 2.1.5 Facility Operating Schedules.

4.7.12 AODD Pump Controls

DESCRIPTION

Diaphragm pumps are widely used for their numerous advantages, such as simplicity, serviceability, and durability. These pumps can tolerate fluids that are corrosive, viscous, or contain a significant portion of entrained solids (E.g., effluent and slurries). Diaphragm pumps can be driven by compressed air or electric motors. Air-operated double diaphragm (AODD) pumps are estimated to be present in up to 85-90% of manufacturing plants in the US.¹⁵⁹⁹ The intrinsic simplicity of AODDs allow them to have significantly lower upfront material costs than electric motor-driven diaphragm pumps since there is no electric motor.

Typically, AODDs are operated at a fixed capacity and do not have a controller attached. In this scenario, the pump consumes compressed air continuously when operating. An electronic stroke controller can reduce the amount of air that the AODD pump consumes while operating. This controller synchronizes the compressed air release with the pump so that the diaphragm experiences a burst of air rather than a continuous stream. This reduces the air consumption and noise generation of the pump. This technology increases the pressure variance experienced by the pump; however, the overall impact on fluid flow is negligible.¹⁶⁰⁰

Typically, this technology is limited to larger AODD pump sizes ($\geq 2''$), higher pressures (≥ 60 psig) and applications with longer operation times. This technology might not be applicable for systems with highly viscous fluids.

This measure was developed to be applicable to the following program types: RF, TOS. If applied to other program types, the measure savings should be verified.

DEFINITION OF EFFICIENT EQUIPMENT

The efficient equipment is an AODD pump with an electronic stroke optimizing control.

DEFINITION OF BASELINE EQUIPMENT

The baseline equipment is an AODD pump operating at a fixed capacity.

DEEMED LIFETIME OF EFFICIENT EQUIPMENT

10 years¹⁶⁰¹

DEEMED MEASURE COST

Total cost is \$1,150. The material cost for this type of control is \$950.¹⁶⁰² Labor is \$200, based on estimated time of 2 hours and \$100 per hour rate.¹⁶⁰³

LOADSHAPE

Loadshape C35 – Industrial Process

COINCIDENCE FACTOR

The summer peak coincidence factor for this measure is dependent on the industrial shift and corresponding hours of operation. Values are provided for each shift type in the variable definition section.

Algorithm

¹⁵⁹⁹ Hank Van Ormer. "Study Proves Potential Energy Savings of AODD Pump Controls," Compressed Air Best Practices.

<https://www.airbestpractices.com/system-assessments/end-uses/study-proves-potential-energy-savings-aodd-pump-controls>

¹⁶⁰⁰ "Diaphragm Pump Controller Performance Project Report," Purdue School of Engineering and Technology. January 12, 2015.

¹⁶⁰¹ This is an estimated based on lifetimes of similar electronic controls. HVAC controls generally have a 15-year EUL but are typically in less demanding environments than industrial pumping applications (e.g., manufacturing, wastewater treatment, etc.). For this reason, a more conservative value of 10 years was selected.

¹⁶⁰² MizAir.com. Accessed August 4, 2020. <https://www.mizair.com/lp-miz>

¹⁶⁰³ Engineering judgement.

CALCULATION OF ENERGY SAVINGS

ELECTRIC ENERGY SAVINGS

$$\Delta kWh = CFM_{AODD} * kW_{Comp} * Hours * SF$$

Where:

CFM_{AODD} = Rated flow of the AODD (CFM). Use actual, if known.

If unknown, see below for guidance.¹⁶⁰⁴

Nominal Pump Size	Pressure Air Rang (psig)	Range of Air Consumption (SCFM)	Default Air Consumption (SCFM)
2"	80 – 120 psig (average = 95 psig)	90 – 120	105
3" & 4"	90 – 110 psig (average = 100 psig)	125 - 150	138

kW_{Comp} = System power reduction per air demand (kW/CFM) depending on the type of air compressor found in table below.¹⁶⁰⁵

Air Compressor Type	kW_{Comp} (kW/CFM)
Reciprocating – On/off Control	0.184
Reciprocating – Load/Unload	0.136
Screw – Load/Unload	0.152
Screw – Inlet Modulation	0.055
Screw – Inlet Modulation w/ Unloading	0.055
Screw – Variable Displacement	0.153
Screw – VFD	0.178

Or if compressor control type is unknown, then a weighted average based on market share can be used:¹⁶⁰⁶

Control Type	Share %	kW / CFM
Market share estimation for load/unload controls compressors	40%	0.136
Market share estimation for modulation w/ unloading control compressors	40%	0.055
Market share estimation for variable displacement control compressors	20%	0.153
Unknown / Weighted average		0.107

Hours = Compressed air system pressurized hours

= Use actual hours if known, otherwise assume values in table below:

¹⁶⁰⁴ "Demand-Side Savings: Energy Efficiency in Optimizing Compressed Air," Air Power USA. Page 8-46.

¹⁶⁰⁵ Calculated based on the type of compressor control. This assumes the compressor will be between 40% and 100% capacity before and after the changes to the system demand. See "Industrial System Standard Deemed Saving Analysis.xls"

¹⁶⁰⁶ Table 8.2.3, Technical Support Document. US Department of Energy

Shift	Hours
Single Shift	1,976
Two Shifts	3,952
Three Shifts	5,928
Four Shifts or Continual Operation	8,320
Unknown / Weighted average ¹⁶⁰⁷	5,702

SF = Savings Factor, representing the reduction of compressed air consumed by the pump
 = 35%¹⁶⁰⁸

For example, a 2-inch AODD is outfitted with a stroke-optimizing control in a Screw – Load/Unload compressor

$\Delta kWh = 105 * 0.152 * 5,702 * 35\%$
 $= 31,851 \text{ kWh}$

SUMMER COINCIDENT PEAK DEMAND SAVINGS

$\Delta kW = \Delta kWh / \text{Hours} * CF$

Where:

ΔkWh = As calculated above
 CF = Summer peak coincidence factor

Shift	Coincidence Factor
Single Shift	0.59
Two Shifts	0.95
Three Shifts	0.95
Four Shifts or Continual Operation	0.95
Unknown / Weighted average ¹⁶⁰⁹	0.89

For example, a 2-inch AODD is outfitted with a stroke-optimizing control in a Screw – Load/Unload compressor

$\Delta kW = 31,851 / 5,702 * 0.89$
 $= 4.97 \text{ kW}$

FOSSIL FUEL SAVINGS

N/A

WATER AND OTHER NON-ENERGY IMPACT DESCRIPTIONS AND CALCULATION

N/A

¹⁶⁰⁷ Weighting of 16% single shift, 23% two shift, 25% three shift and 36% continual based on DOE evaluation of the Compressed Air Challenge, section 2.1.5 Facility Operating Schedules

¹⁶⁰⁸ This is the average value of several references, the strongest of which is a lab study that reports a savings range of 20% - 50%. “Diaphragm Pump Controller Performance Project Report,” Purdue School of Engineering and Technology. January 12, 2015. For a full list of savings estimates, see the “IL TRM AODD Controls – Supporting Info.xls”

¹⁶⁰⁹ Weighting of 16% single shift, 23% two shift, 25% three shift and 36% continual based on DOE evaluation of the Compressed Air Challenge, section 2.1.5 Facility Operating Schedules

DEEMED O&M COST ADJUSTMENT CALCULATION

N/A

MEASURE CODE: CI-CPA-AODD-V02-250101

REVIEW DEADLINE: 1/1/2028

4.7.13 Compressed Air Leak Repair

DESCRIPTION

This measure shows the energy savings potential associated with reducing compressed air losses and the repair of compressed air leaks. Compressed air leaks can be responsible for 20-30% of total air compressor output in a facility. This measure is applicable to compressed air systems in manufacturing environments where blow off, pneumatic tools and manufacturing processes of many varieties are used.

This measure was developed to be applicable to the following program types: RF. If applied to other program types, the measure savings should be verified.

DEFINITION OF EFFICIENT EQUIPMENT

The efficient condition is the compressed air system with air leaks identified via a leak survey and leak tags, and then leaks repaired to minimize compressed air wastage.

DEFINITION OF BASELINE EQUIPMENT

The baseline condition is an existing compressed air system.

DEEMED LIFETIME OF EFFICIENT EQUIPMENT

The expected measure life is 1 to 5 years.¹⁶¹⁰ A range of possible lifetime values is provided as the implementer of this measure must justify the reason for selecting an appropriate measure life for each project and the decision will be subject to evaluation with the risk of adjustment.

DEEMED MEASURE COST

The incremental cost is assumed to be \$8 per horsepower¹⁶¹¹

LOADSHAPE

Loadshape C35 - Industrial Process

COINCIDENCE FACTOR

The summer peak coincidence factor for this measure is dependent on the industrial shift and corresponding hours of operation. Values are provided for each shift type in the variable definition section.

Algorithm

CALCULATION OF ENERGY SAVINGS

ELECTRIC ENERGY SAVINGS

$$\Delta kWh = (N_{leaks} * CFM_{leaks} * Hours * C_{aircomp} * Control\ factor / hp_{typical}) * hp_{real}$$

Where:

N_{leaks} = Number of leaks repaired

¹⁶¹⁰ For more detail pertaining to the guidance of the measure life, please see Attachment B: Effective Useful Life for Custom Measure Guidelines

¹⁶¹¹ Engineering estimate from previous project cost data review and engineering judgment as obtained from Minnesota Technical Reference Manual Version 1.2, Industrial Compressed Air – Compressed Air Leak Detection

CFM_{leaks} = CFM loss per leak from table below¹⁶¹²

Pressure (psig)	Leak Orifice Diameter (inches)					
	1/64	1/32	1/16	1/8	1/4	3/8
70	0.3	1.2	4.8	19.2	76.7	173
80	0.33	1.3	5.4	21.4	85.7	193
90	0.37	1.5	5.9	23.8	94.8	213
100	0.41	1.6	6.5	26	104	234
125	0.49	2	7.9	31.6	126	284

*Values in CFM

$C_{aircomp}$ = Compressor efficiency

= Actual, if unknown compressor type, use 0.19 kW/CFM¹⁶¹³

Type	$C_{aircomp}$ kW/CFM
Single-acting Reciprocating Air Compressor	0.23
Double-acting Reciprocating Air Compressor	0.155
Lubricant-injected Rotary Screw Compressor	0.185
Lubricant-free Rotary Screw Compressor	0.2
Centrifugal Compressor	0.18
Average/unknown	0.19

Hours = Compressor hours of operation below depending on shift:

Shift	Hours	Description
Single shift (8/5)	1,976	7 AM – 3 PM, weekdays, minus three-weekday holidays and 10 days of scheduled down time
2-shift (16/5)	3,952	7AM – 11 PM, weekdays, minus three-weekday holidays and 10 days of scheduled down time
3-shift (24/5)	5,928	24 hours per day, weekdays, minus three-weekday holidays and 10 days of scheduled down time
4-shift (24/7)	8,320	24 hours per day, 7 days a week minus three-week day holidays and 10 days of scheduled down time
Unknown / Weighted average	5,702	

Control factor = Efficiency Factors per control type for air compressors from table below. If unknown control type, use 0.3 %kW/%load¹⁶¹⁴

Control Type	Control factor %kW/%load
Inlet Valve Modulated	0.31
Variable Displacement	0.69
Variable Speed Drive	0.85

¹⁶¹² Leakage rates(cfm) for different supply pressures and approximately equivalent orifice sizes obtained from Energy Tips – Minimize Compressed Air Leaks [Minimize Compressed Air Leaks; Industrial Technologies Program \(ITP\) Compressed Air Tip Sheet #3 \(Fact Sheet\) \(energy.gov\)](#)

¹⁶¹³ Compressed Air Challenge "Fundamentals of Compressed Air Systems" Pg 28-32

¹⁶¹⁴ Compressed Air Challenge "Fundamentals of Compressed Air Systems" Pg 90-91

hp_{typical} = nominal horsepower of a typical air compressor
 = 100 hp¹⁶¹⁵

hp_{real} = total hp of real compressors. This should include the total horsepower of the compressors that normally run through the filter, but not backup compressors
 = Actual

For example, a repair of a 500hp system running at 100psig that fixes 10 leaks that are 1/8” in size would save the following:

$$\begin{aligned} \Delta kWh &= (N_{\text{leaks}} * \text{Hours} * \text{CFM}_{\text{leaks}} * C_{\text{aircomp}} * \text{Control Factor} / hp_{\text{typical}}) * hp_{\text{real}} \\ &= (10 * 5,928 * 0.19 * 0.3\% / 100) * 500 \\ &= 4,392.6 \text{ kWh} \end{aligned}$$

SUMMER COINCIDENT PEAK DEMAND SAVINGS

$$\Delta kW = (\Delta kWh / \text{Hours}) * CF$$

Where,

CF = Summer peak coincidence factor, see table below

Shift	Coincidence Factor
Single shift (8/5)	0.59
2-shift (16/5)	0.95
3-shift (24/5)	0.95
4-shift (24/7)	0.95
Unknown / Weighted average¹⁶¹⁶	0.89

For example, a repair of a 500hp system running at 100psig that fixes 10 leaks that are 1/8” in size would save the following:

$$\begin{aligned} \Delta kW &= (\Delta kWh / \text{Hours}) * CF \\ &= (4,392.6 / 5,928) * 0.89 \\ &= 0.66 \text{ kW} \end{aligned}$$

FOSSIL FUEL SAVINGS

N/A

WATER AND OTHER NON-ENERGY IMPACT DESCRIPTIONS AND CALCULATION

N/A

DEEMED O&M COST ADJUSTMENT CALCULATION

N/A

¹⁶¹⁵ Consistent with 4.7.2 Compressed Air Low Pressure Drop Filters. See “Industrial System Standard Deemed Saving Analysis.xls”.

¹⁶¹⁶ Weighting of 16% single shift, 23% two shift, 25% three shift and 36% continual based on DOE evaluation of the Compressed Air Challenge, section 2.1.5 Facility Operating Schedules.

MEASURE CODE: CI-CPA-CALR-V02-250101

REVIEW DEADLINE: 1/1/2029

4.8.Shell End Use

4.8.1 Roof Insulation for C&I Facilities

DESCRIPTION

Energy and demand savings are realized through reductions in the building cooling and heating loads by way of improvements in roof assembly thermal resistance properties. This measure was developed to be applicable to the following program types: RF and NC.

If applied to other program types, the measure savings should be verified.

DEFINITION OF EFFICIENT EQUIPMENT

The efficient condition is a roof assembly with thermal resistance that exceeds code requirements and should be determined by the program.

DEFINITION OF BASELINE EQUIPMENT

The baseline condition in retrofit scenarios is the thermal resistance of the existing roof assembly.

The baseline for new construction scenarios is the thermal resistance of the roof assembly as mandated by applicable building code. Assembly R-values shall be referenced from IECC 2015 or ASHRAE – 90.1 – 2013, or IECC 2018 or ASHRAE 90.1-2016, or IECC 2021, depending on the IECC in effect on the date of the building permit (if unknown assume IECC 2018).

Note, IECC 2021 became effective statewide on 1/1/2024. IECC 2018 is the requisite code for any projects with permitting dates spanning July 1, 2019 to 12/31/2023. Prior to July 1, 2019, IECC 2015 is the applicable code. As code requirements and adoption can differ from municipality to municipality, the user should verify which version of code is applicable given these constraints.

DEEMED LIFETIME OF EFFICIENT EQUIPMENT

The measure expected useful life (EUL) is assumed to be 20 years per DEER 2008. This is consistent with SDG&E’s 9th Year Measure Retrofit Study (1996 & 1997 Residential Weatherization Programs), CPUC’s Energy Efficiency Policy Manual v.2, and GDS’s Measure Life Report Residential and Commercial/Industrial Lighting and HVAC Measures (June 2007).

DEEMED MEASURE COST

Costs can be highly variable due to differences in building type and structural assemblies and therefore actual costs should be used when possible. Absent of actual cost information, estimated costs can be used. Per the W017 Itron California Measure Cost Study,¹⁶¹⁷ the material cost for R-30 insulation is \$0.59 per square foot. The installation cost is \$0.81 per square foot. The total measure cost, therefore, is \$1.40 per square foot of insulation installed.

LOADSHAPE

Loadshape C03: Commercial Cooling

Loadshape C04 - Commercial Electric Heating

Loadshape C05 - Commercial Electric Heating and Cooling

COINCIDENCE FACTOR

CF_{SSP} = Summer System Peak Coincidence Factor for Commercial cooling (during system peak hour)

¹⁶¹⁷ Measure costs are from the “2010-2012 W0017 Ex Ante Measure Cost Study”, Itron, California Public Utilities Commission, May 2014. The data is provided in a file named “MCS Results Matrix – Volume I”.

$$= 91.3\%^{1618}$$

CF_{PJM} = PJM Summer Peak Coincidence Factor for Commercial cooling (average during peak period)

$$= 47.8\%^{1619}$$

Algorithm

CALCULATION OF ENERGY SAVINGS

ELECTRIC ENERGY SAVINGS

Electric energy savings is calculated as the sum of energy saved when cooling the building and energy saved when heating the building

$$\Delta kWh = \Delta kWh_{cooling} + \Delta kWh_{heating}$$

If central cooling, the electric energy saved in annual cooling due to the added insulation is

$$\Delta kWh_{cooling} = ((1/R_{existing}) - (1/R_{new})) * Area * EFLH_{cooling} * \Delta T_{FL,cooling} / 1,000 / \eta_{cooling}$$

Where:

$R_{existing}$ = Roof assembly heat loss coefficient with existing (or code required) insulation [(hr-°F-ft²)/Btu]

= In retrofit scenarios, actual existing conditions prior to retrofit should be used. If unavailable, default values by building type can be used, as outlined in the following table and adopted from Ohio Energy Technical Reference Manual and expanded to cover all type of commercial buildings in the state of Illinois. In new construction scenarios, the applicable code requirements, per the following tables, should be used.

For retrofits, the R-value for the entire assembly:

Building Type	Retrofit Assembly R-Value
Assembly	13.5
Assisted Living	13.5
College	13.5
Convenience Store	13.5
Elementary School	13.5
Garage	13.5
Grocery	13.5
Healthcare Clinic	13.5
High School	13.5
Hospital	13.5
Hotel/Motel	13.5
Manufacturing Facility	12.0
MF - High Rise	13.5
MF - Mid Rise	13.5
Movie Theater	13.5
Office - High Rise	13.5
Office - Low Rise	13.5

¹⁶¹⁸ Based on analysis of Itron eShape data for Missouri, calibrated to Illinois loads, supplied by Ameren. The AC load during the utility’s peak hour is divided by the maximum AC load during the year.

¹⁶¹⁹ Based on analysis of Itron eShape data for Missouri, calibrated to Illinois loads, supplied by Ameren. The average AC load over the PJM peak period (1-5pm, M-F, June through August) is divided by the maximum AC load during the year.

Building Type	Retrofit Assembly R-Value
Office - Mid Rise	13.5
Religious Building	13.5
Restaurant	13.5
Retail - Department Store	13.5
Retail - Strip Mall	13.5
Warehouse	12.0
Unknown	13.5

R-Values: ASHRAE – 90.1 – 2013 and 2016

	IL TRM Zones 1, 2, & 3 [ASHRAE/IECC Climate Zone 5 (A, B, C)]			
	Nonresidential		Semiheated	
	Assembly Maximum	Insulation Min. R-Value	Assembly Maximum	Insulation Min. R-Value
Insulation Entirely Above Deck	0.032	R-30.0 c.i.	0.063	R-15 c.i.
Metal Building (Roof)	0.037	R-19 + R-11 Ls or R-25 + R-8 Ls	0.082	R-19
Attic and Other	0.021	R-49	0.034	R-30

	IL TRM Zones 4 & 5 [ASHRAE/IECC Climate Zone 4 (A, B, C)]			
	Nonresidential		Semiheated	
	Assembly Maximum	Insulation Min. R-Value	Assembly Maximum	Insulation Min. R-Value
Insulation Entirely Above Deck	0.032	R-30.0 c.i.	0.093	R-10 c.i.
Metal Building (Roof)	0.037	R-19 + R-11 Ls or R-25 + R-8 Ls	0.082	R-19
Attic and Other	0.021	R-49	0.034	R-30

Table Notes
c.i. = continuous insulation

Ls = linear system, a continuous vapor barrier liner installed below the purlins and uninterrupted by framing members

R_{new} = Roof assembly heat loss coefficient with new insulation [(hr-°F-ft²)/Btu]

Area = Area of the roof surface in square feet.

$EFLH_{cooling}$ = Equivalent Full Load Hours for Cooling [hr] in Existing Buildings or New Construction are provided in Section 4.4, HVAC end use

$\Delta T_{FL,cooling}$ = Temperature difference [°F] during cooling season between design day outdoor air temperature (T_{DD}) and assumed 55°F base temperature

Climate Zone (City based upon)	$T_{DD,cooling}$ [°F] ¹⁶²⁰	$\Delta T_{FL,cooling}$ [°F]
1 (Rockford)	90.9	35.9

¹⁶²⁰ Weather Station Data, 0.4% Cooling DB - 2021 ASHRAE Handbook, Fundamentals. The following weather stations were referenced: Climate Zone 1: Chicago Rockford Int'l, Climate Zone 2: Chicago O'Hare Int'l, Climate Zone 3: Abraham Lincoln Capital, Climate Zone 4: Scott AFB, Climate Zone 5: Cape Girardeau Regional.

Climate Zone (City based upon)	T _{DD,cooling} [°F] ¹⁶²⁰	ΔT _{FL,cooling} [°F]
2 (Chicago)	91.3	36.3
3 (Springfield)	92.6	37.6
4 (Belleville)	95.2	40.2
5 (Marion)	94.4	39.4

1,000 = Conversion from Btu to kBtu

η_{cooling} = Efficiency of cooling system. Actual, if known. Alternatively, use IECC 2012 as a default source if equipment type is known, or as deemed assume SEER 13¹⁶²¹

If the building is heated with electric heat (resistance or heat pump), the electric energy saved in annual heating due to the added insulation is

$$\Delta kWh_{heating} = [(1/R_{existing}) - (1/R_{new})] * Area * EFLH_{heating} * \Delta T_{FL,heating} / 3,412 / \eta_{heating}$$

Where:

EFLH_{heating} = Equivalent Full Load Hours for Heating [hr] in Existing Buildings or New Construction are provided in Section 4.4, HVAC end use

ΔT_{FL,heating} = Temperature difference [°F] during heating season between design day outdoor air temperature and assumed 55°F heating base temperature

Climate Zone (City based upon)	T _{DD,heating} [°F] ¹⁶²²	ΔT _{FL,heating} [°F]
1 (Rockford)	-5.4	60.4
2 (Chicago)	-1.0	56.0
3 (Springfield)	1.1	53.9
4 (Belleville)	7.2	47.8
5 (Marion)	10.1	44.9

3,142 = Conversion from Btu to kWh.

η_{heating} = Efficiency of heating system. Use actual efficiency. If not available refer to default table below.

System Type	Age of Equipment	HSPF Estimate	η _{Heat} (Effective COP Estimate) (HSPF/3.413)*0.85
Heat Pump	Before 2006	6.8	1.7
	After 2006	7.7	1.92
Resistance	N/A	N/A	1

If the building is heated with a gas furnace, there will be some electric savings in heating the building attributed to extra insulation since the furnace fans will run less.

$$\Delta kWh_{heating} = \Delta Therms * Fe * 29.3$$

¹⁶²¹ Simplified version of IECC 2012 as a conservative estimate of what is existing.

¹⁶²² Weather Station Data, 96.6% Heating DB - 2021 ASHRAE Handbook, Fundamentals. The following weather stations were referenced: Climate Zone 1: Chicago Rockford Int'l, Climate Zone 2: Chicago O'Hare Int'l, Climate Zone 3: Abraham Lincoln Capital, Climate Zone 4: Scott AFB, Climate Zone 5: Cape Girardeau Regional.

Where:

- Δ Therms = Gas savings calculated with equation below.
- Fe = Percentage of heating energy consumed by fans, assume 7.7%¹⁶²³
- 29.3 = Conversion from therms to kWh

SUMMER COINCIDENT PEAK DEMAND SAVINGS

$$\Delta kW = (\Delta kWh_{cooling} / EFLH_{cooling}) * CF$$

Where:

- EFLH_{cooling} = Equivalent full load hours of air conditioning in Existing Buildings or New Construction are provided in Section 4.4, HVAC end use
- CF_{SSP} = Summer System Peak Coincidence Factor for Commercial cooling (during system peak hour)
= 91.3%¹⁶²⁴
- CF_{PJM} = PJM Summer Peak Coincidence Factor for Commercial cooling (average during peak period)
= 47.8%¹⁶²⁵

FOSSIL FUEL SAVINGS

If building uses a gas furnace, the savings resulting from the insulation is calculated using the following formula.

$$\Delta Therms = ((1/R_{existing}) - (1/R_{new})) * Area * EFLH_{heating} * \Delta T_{FL,heating} / 100,000 / \eta_{heat}$$

Where:

- R_{existing} = Roof assembly heat loss coefficient with existing (or code required) insulation [(hr-°F-ft²)/Btu], per guidance outlined in Electric Energy Savings section.
- R_{new} = Roof assembly heat loss coefficient with new insulation [(hr-°F-ft²)/Btu]
- Area = Area of the roof surface in square feet. Assume 1000 sq ft for planning.
- EFLH_{heating} = Equivalent Full Load Hours for Heating in Existing Buildings or New Construction are provided in Section 4.4, HVAC end use
- $\Delta T_{FL,heating}$ = Temperature difference [°F] during heating season between design day outdoor air temperature and assumed 55°F heating base temperature (see above)
- 100,000 = Conversion from BTUs to Therms
- η_{heat} = Efficiency of existing furnace. Assume 0.78 for planning purposes.

WATER IMPACT DESCRIPTIONS AND CALCULATION

N/A

¹⁶²³ F_e is estimated using TRM models for the three most popular building types for programmable thermostats: low-rise office (10.2%), sit-down restaurant (8.6%), and retail – strip mall (4.4%). 7.7% reflects the average F_e of the three building types. See “Fan Energy Factor Example Calculation 2021-06-23.xlsx” for reference.

¹⁶²⁴ Based on analysis of Itron eShape data for Missouri, calibrated to Illinois loads, supplied by Ameren. The AC load during the utility’s peak hour is divided by the maximum AC load during the year.

¹⁶²⁵ Based on analysis of Itron eShape data for Missouri, calibrated to Illinois loads, supplied by Ameren. The average AC load over the PJM peak period (1-5pm, M-F, June through August) is divided by the maximum AC load during the year.

DEEMED O&M COST ADJUSTMENT CALCULATION

N/A

MEASURE CODE: CI-SHL-RINS-V09-250101

REVIEW DEADLINE: 1/1/2029

4.8.2 Spring-Loaded Garage Door Hinge

DESCRIPTION

Existing overhead doors often close loosely at the perimeter weather strips and between panels. Conditioned air escapes through these gaps, leading to energy loss. Spring-loaded hinges create tension and reduce gaps at the perimeter and between panels. The product is applicable for small-commercial and residential sectors, but the savings estimated by this measure apply only to small-commercial applications. This measure applies to sites where the inside area of the garage is conditioned during the heating season by natural gas.

This measure was developed to be applicable to the following program types: NC, RF. If applied to other program types, the measure savings should be verified as a custom measure.

DEFINITION OF EFFICIENT EQUIPMENT

The efficient equipment consists of a heavy-duty spring-loaded hinge installed in place of a standard hinge on a garage overhead door. The number of hinges per project may vary depending on the door type, size, and number of panels. The efficient condition is an air sealed garage door with no gaps around the perimeter or between panels.

DEFINITION OF BASELINE EQUIPMENT

The baseline equipment is a garage door with a 1/8-inch gap between the door and the weather-stripping around the perimeter of the door. The bottom of the door is assumed sealed.

DEEMED LIFETIME OF EFFICIENT EQUIPMENT

The expected measure life is assumed to be 20 years.¹⁶²⁶

DEEMED MEASURE COST

Incremental costs equal installed cost and will vary based on the number of hinges required per door. Based on information provided by the manufacturer to Nicor Gas, average material cost is \$126 per garage door and installation cost is \$63 per garage door for a total installed cost of \$189 per garage door. The typical garage door is assumed to have 4 panels and 9 total hinges.

LOADSHAPE

N/A

COINCIDENCE FACTOR

N/A

Algorithm

CALCULATION OF ENERGY SAVINGS

Savings are calculated based on a reduction in airflow rate associated with decreased infiltration across the leakage area. The algorithm below for change in cubic feet per minute, ΔCFM , is modeled after equation 48 in Chapter 16: Ventilation and infiltration of the 2017 ASHRAE Handbook—Fundamentals.

ELECTRIC ENERGY SAVINGS

N/A

SUMMER COINCIDENT PEAK DEMAND SAVINGS

N/A

¹⁶²⁶ Public Service Commission of Wisconsin, "Evaluation – Business Program: Measure Life Study," Focus on Energy (2009): page 1-4, Table 1-2 Recommended Measure Life by WISEerts Group Description for Building Shell Equip or Tech measure type, accessed March 26, 2019, https://focusonenergy.com/sites/default/files/bpmeasurelifestudyfinal_evaluationreport.pdf.

FOSSIL FUEL SAVINGS

$$\Delta CFM = A_l * [(C_s * \Delta T) + (C_w * W_s^2)]^{0.5}$$

$$\Delta HeatLoad = \Delta CFM * Conv_{min} * Density_{air} * SpecificHeat_{air} * \Delta T$$

$$\Delta therm_{s_{Hr}} = \Delta HeatLoad / Eff_{heat} / Conv_{BTU}$$

$$\Delta therm_{s_{Ann}} = \Delta therm_{s_{Hr}} * Hours$$

Where:

A_l = Leakage area, estimated at 51 (in²), of air gap before retrofit.¹⁶²⁷

C_s = Stack coefficient, 0.0299 (cfm²/in⁴ * °F), adjustment based on airflow at average building height.¹⁶²⁸

C_w = Wind coefficient, 0.0086 (cfm²/in⁴ * mph²), adjustment based on airflow at average building height and wind shelter classification.¹⁶²⁹

ΔT = Average temperature difference between outside air temperature (OAT) during the heating season¹⁶³⁰ and assumed indoor heating temperature setpoint 70°F;¹⁶³¹ see table below.

W_s = Average wind speed (mph) during heating season, see table below.

Climate Zone	Average OAT, Heating (°F)	Average Delta T, Heating (°F)	Average heating Season Wind Speed (mph) ¹⁶³²
1 (Rockford)	32	38	10
2 (Chicago)	34	36	10
3 (Springfield)	35	35	10
4 (Belleville)	36	34	9
5 (Marion)	39	31	7

$Conv_{min}$ = Conversion from minutes to hours, 60 minutes/hour.

$Density_{air}$ = The density of air, 0.08 (lb/ft³) at 1 atmosphere pressure and approximately 30-40°F.¹⁶³³

$SpecificHeat_{air}$ = Specific heat of air, 0.24 (BTU/lb) at 1 atmosphere pressure and 32°F.¹⁶³⁴

¹⁶²⁷ Leakage area is estimated based on average door size of installations previously completed in Wisconsin and reported in the Wisconsin Focus on Energy Technical Reference Manual. Average door size is 10 ft x 12 ft, with a side and top perimeter equal to 1 top * (10 ft * 12 in/1 ft) + 2 sides* (12 ft * 12 in/1ft) = 408 in. At 1/8 in perimeter gap, the leakage area is 408 in * 1/8 in = 51 in².

¹⁶²⁸ 2017 ASHRAE Handbook—Fundamentals, 16.24, Table 4 “Basic Model Stack Coefficient C_s ”, assumed average building height of 16 feet, two-story.

¹⁶²⁹ 2017 ASHRAE Handbook—Fundamentals, 16.24, Table 6 “Basic Model Wind Coefficient C_w ”, assumed average building height of 16 feet and shelter class 3: “Typical shelter caused by other buildings across street from building under study.”

¹⁶³⁰ DOE Weather Data, TMY3 (Typical Meteorological Year), developed by NREL, for the average outdoor temperature when the heating system is expected to be operating.

¹⁶³¹ Energy Center of Wisconsin, “Baseline Building Energy Models – Nonresidential Heating Thermostat Setpoint,” ComEd Portfolio Modeling Report (July 2010): page 6.

¹⁶³² DOE Weather Data, TMY3 (Typical Meteorological Year), developed by NREL, for the average wind speed when the heating system is expected to be operating, defined as hours where the average temperature is lower than 55°F.

¹⁶³³ Engineering ToolBox, (2003). Air - Density, Specific Weight and Thermal Expansion Coefficient at Varying Temperature and Constant Pressures. [online] Available at: https://www.engineeringtoolbox.com/air-density-specific-weight-d_600.html [Accessed March 2019].

¹⁶³⁴ Engineering ToolBox, (2004). Air - Specific Heat at Constant Pressure and Varying Temperature. [online] Available at: https://www.engineeringtoolbox.com/air-specific-heat-capacity-d_705.html [Accessed March 2019].

Eff_{heat} = Efficiency of the heating system, assume 0.78 for planning purposes.¹⁶³⁵

$Conv_{BTU}$ = Conversion from BTUs to therms, 100,000 BTU/therm.

$EFLH_H$ =Equivalent Full Load Heating Hours in Existing Buildings or New Construction are listed in section 4.4 HVAC End Use, but a subset of the building types most likely to use this measure are repeated here for easy reference.

EFLH Existing Buildings					
Building Type	Zone 1 (Rockford)	Zone 2 (Chicago)	Zone 3 (Springfield)	Zone 4 (Belleville)	Zone 5 (Marion)
Convenience Store	1,481	1,368	1,214	871	973
Garage	958	969	852	680	1,047
High School	1,845	1,857	1,666	1,187	1,388
Manufacturing	1,048	1,013	939	567	634
Office - Low Rise	1,428	1,425	1,132	692	793
Retail - Strip Mall	1,347	1,325	1,183	1,064	1,096
Warehouse	1,285	1,286	1,180	1,147	1,224

EFLH New Construction					
Building Type	Zone 1 (Rockford)	Zone 2 (Chicago)	Zone 3 (Springfield)	Zone 4 (Belleville)	Zone 5 (Marion)
Convenience Store	1,481	1,368	1,214	871	973
Garage	958	969	852	680	1,047
High School	1,807	1,642	2,093	2,292	1,830
Manufacturing	1,048	1,013	939	567	634
Office - Low Rise	947	989	1,090	1,302	1,076
Retail - Strip Mall	722	789	667	834	911
Warehouse	389	522	408	527	567

Savings for all climate zones and selected building types are presented in the following table.

Annual Therm Savings Existing Buildings					
Building Type	Zone 1 (Rockford)	Zone 2 (Chicago)	Zone 3 (Springfield)	Zone 4 (Belleville)	Zone 5 (Marion)
Convenience Store	59.89	51.62	44.19	29.20	26.38
Garage	38.74	36.56	31.01	22.79	28.39
High School	74.61	70.07	60.64	39.79	37.63
Manufacturing	42.38	38.22	34.18	19.01	17.19
Office - Low Rise	57.75	53.77	41.21	23.20	21.50
Retail - Strip Mall	54.47	50.00	43.06	35.67	29.72
Warehouse	51.97	48.53	42.95	38.45	33.19

¹⁶³⁵ To maintain consistency across assumptions within the IL TRM, this value is equal to the furnace efficiency value listed in 4.8.2 Roof Insulation for C&I Facilities measure.

Annual Therm Savings New Construction					
Building Type	Zone 1 (Rockford)	Zone 2 (Chicago)	Zone 3 (Springfield)	Zone 4 (Belleville)	Zone 5 (Marion)
Convenience Store	59.89	51.62	44.19	29.20	26.38
Garage	38.74	36.56	31.01	22.79	28.39
High School	73.08	61.96	76.19	76.83	49.62
Manufacturing	42.38	38.22	34.18	19.01	17.19
Office - Low Rise	38.30	37.32	39.68	43.64	29.17
Retail - Strip Mall	29.20	29.77	24.28	27.96	24.70
Warehouse	15.73	19.70	14.85	17.67	15.37

Savings for all climate zones and selected building types per linear foot are presented in the following table.

Annual Therm Savings per Linear Foot Existing Buildings					
Building Type	Zone 1 (Rockford)	Zone 2 (Chicago)	Zone 3 (Springfield)	Zone 4 (Belleville)	Zone 5 (Marion)
Convenience Store	1.76	1.52	1.30	0.86	0.78
Garage	1.14	1.08	0.91	0.67	0.83
High School	2.19	2.06	1.78	1.17	1.11
Manufacturing	1.25	1.12	1.01	0.56	0.51
Office - Low Rise	1.70	1.58	1.21	0.68	0.63
Retail - Strip Mall	1.60	1.47	1.27	1.05	0.87
Warehouse	1.53	1.43	1.26	1.13	0.98

Annual Therm Savings per Linear Foot New Construction					
Building Type	Zone 1 (Rockford)	Zone 2 (Chicago)	Zone 3 (Springfield)	Zone 4 (Belleville)	Zone 5 (Marion)
Convenience Store	1.76	1.52	1.30	0.86	0.78
Garage	1.14	1.08	0.91	0.67	0.83
High School	2.15	1.82	2.24	2.26	1.46
Manufacturing	1.25	1.12	1.01	0.56	0.51
Office - Low Rise	1.13	1.10	1.17	1.28	0.86
Retail - Strip Mall	0.86	0.88	0.71	0.82	0.73
Warehouse	0.46	0.58	0.44	0.52	0.45

WATER AND OTHER NON-ENERGY IMPACT DESCRIPTIONS AND CALCULATION

N/A

DEEMED O&M COST ADJUSTMENT CALCULATION

N/A

MEASURE CODE: CI-SHL-SLDH-V01-200101

REVIEW DEADLINE: 1/1/2026

4.8.3 Commercial Weather Stripping

DESCRIPTION

Note- this measure provides a prescriptive approach for commercial door sweeps. A more comprehensive approach that requires a number of additional inputs for both this and a number of other commercial air sealing opportunities is provided in measure 4.8.27 C&I Air Sealing.

Entrance/exit doors installed for a commercial or industrial buildings often leave clearance gaps to allow for proper operation. The gaps around the doors allow unconditioned air to infiltrate the building due to wind force, internal building stack affect, and other temperature differentials, thus adding to the cooling and heating loads of an HVAC system. Sweeps and other weatherstripping applications are designed to close these gaps, while still allowing proper operation. They are installed along the bottom, head, and jambs of exterior doors to prevent air infiltration from adding to the HVAC load.

This measure was developed to be applicable to the following program types: RF, DI. If applied to other program types, the measure savings should be verified.

DEFINITION OF EFFICIENT EQUIPMENT

There are a variety of types of materials used as door sweeps and weather stripping, including nylon bristles, felt, vinyl, open or closed-cell foam, and EPDM rubber. Their effectiveness is assumed to be the same when properly installed.

DEFINITION OF BASELINE EQUIPMENT

This measure shall apply to the exterior doors on commercial buildings that are not sealed from the outside environment (i.e., interior vestibule doors would be ineligible) with visible gaps of at least 1/8 inches and up to 3/4 inches along any outside edge of the door. The space on the interior of the door must be conditioned and/or heated, and the calculation methodology will use standard efficiencies of 1.0 kW/ton for cooling and 80% for heating. Electric resistance heating and electric heat pump systems will use coefficients of performance (COPs) of 1.0 and 3.3, respectively.

DEEMED LIFETIME OF EFFICIENT EQUIPMENT

The estimated useful life (EUL) is 10 years.¹⁶³⁶

DEEMED MEASURE COST

Costs for this measure should be determined by actual quotes obtained from manufacturers and estimated labor. If not available, it is estimated based on brush weather strips cost of \$5.50/LF with labor and other direct costs of installation costing \$2.50/LF with the total coming to \$8.00/LF.¹⁶³⁷

LOADSHAPE

Loadshape C03 - Commercial Cooling

Loadshape C04 - Commercial Electric Heating

Loadshape C05 - Commercial Electric Heating and Cooling

COINCIDENCE FACTOR

$$\begin{aligned} CF_{SSP} &= \text{Summer System Peak Coincidence Factor for Commercial cooling (during system peak hour)} \\ &= 91.3\% \quad ^{1638} \end{aligned}$$

¹⁶³⁶ Assumed lower than residential due to likely significantly higher door usage.

¹⁶³⁷ Deemed costs referenced from the Arkansas TRM.

¹⁶³⁸ Based on analysis of Itron eShape data for Missouri, calibrated to Illinois loads, supplied by Ameren. The AC load during the utility's peak hour is divided by the maximum AC load during the year.

$$CF_{PJM} = \text{PJM Summer Peak Coincidence Factor for Commercial cooling (average during peak period)}$$

$$= 47.8\%^{1639}$$

Algorithm

CALCULATION OF ENERGY SAVINGS

ELECTRIC ENERGY SAVINGS

$$\Delta kWh = (\Delta kWh_{Cool_{weatherstrip}} + \Delta kWh_{Heat_{weatherstrip}}) * \text{Length}$$

Where:

$$\Delta kWh_{Cool_{weatherstrip}} = \text{Annual cooling kWh savings from installation of door sweep per linear foot}^{1640}$$

Climate Zone (City based upon)	$\Delta kWh_{Cool_{weatherstrip}}$ per linear ft
1 (Rockford)	0.33
2 (Chicago)	0.36
3 (Springfield)	0.63
4 (Belleville)	0.59
5 (Marion)	0.70

$$\Delta kWh_{Heat_{weatherstrip}} = \text{Annual heating kWh savings from installation of door sweep per linear foot}^{1641}$$

Climate Zone (City based upon)	$\Delta kWh_{weatherstrip}$ per linear ft	
	Electric Resistance	Heat Pump
1 (Rockford)	89.4	44.7
2 (Chicago)	78.6	39.3
3 (Springfield)	69.2	34.6
4 (Belleville)	59.9	29.9
5 (Marion)	48.0	24.0

$$\text{Length} = \text{Linear feet of door weatherstripping installed}$$

SUMMER COINCIDENT PEAK DEMAND SAVINGS

$$\Delta kW = (\Delta kWh_{Cool_{weatherstrip}} * \text{Length}) / EFLH_{cooling} * CF$$

Where:

$$EFLH_{cooling} = \text{Equivalent full load hours of air conditioning in Existing Buildings or New Construction are provided in Section 4.4, HVAC end use}$$

¹⁶³⁹Based on analysis of Itron eShape data for Missouri, calibrated to Illinois loads, supplied by Ameren. The average AC load over the PJM peak period (1-5pm, M-F, June through August) is divided by the maximum AC load during the year.

¹⁶⁴⁰Savings are based on lab test results performed by CLEAResult, assuming a 1/8" gap. See 'Commercial Weather Stripping IL_TRM_Workpaper v1.2'. Following discussion with the TAC it was determined that due to concerns over engineering algorithms overclaiming savings, 50% of the savings for the 1/8" gap are deemed appropriate.

¹⁶⁴¹Converts the Therm value to kWh and incorporates the relative COP efficiencies (assumed 0.78 for gas heat, 1 for electric resistance and 2.0 for heat pumps).

CF_{SSP} = Summer System Peak Coincidence Factor for Commercial cooling (during system peak hour)

= 91.3%¹⁶⁴²

CF_{PJM} = PJM Summer Peak Coincidence Factor for Commercial cooling (average during peak period)

= 47.8%¹⁶⁴³

FOSSIL FUEL SAVINGS

$\Delta\text{Therms} = \Delta\text{Therms}_{\text{Weatherstrip}} * \text{Length}$

Where:

$\Delta\text{Therms}_{\text{Weatherstrip}}$ = Annual therm savings from installation of door sweep per linear foot¹⁶⁴⁴

Climate Zone (City based upon)	$\Delta\text{Therms}_{\text{Weatherstrip}}$ per linear ft
1 (Rockford)	3.91
2 (Chicago)	3.44
3 (Springfield)	3.03
4 (Belleville)	2.62
5 (Marion)	2.1

Length = Linear feet of door weatherstripping installed

WATER AND OTHER NON-ENERGY IMPACT DESCRIPTIONS AND CALCULATION

NA

DEEMED O&M COST ADJUSTMENT CALCULATION

NA

MEASURE CODE: CI-SHL-WTST-V02-230101

REVIEW DEADLINE: 1/1/2027

¹⁶⁴² Based on analysis of Itron eShape data for Missouri, calibrated to Illinois loads, supplied by Ameren. The AC load during the utility’s peak hour is divided by the maximum AC load during the year.

¹⁶⁴³ Based on analysis of Itron eShape data for Missouri, calibrated to Illinois loads, supplied by Ameren. The average AC load over the PJM peak period (1-5pm, M-F, June through August) is divided by the maximum AC load during the year.

¹⁶⁴⁴ Savings are based on lab test results performed by CLEAResult, assuming an 1/8” gap. See ‘Commercial Weather Stripping IL_TRM_Workpaper v1.2’. Following discussion with the TAC it was determined that due to concerns over engineering algorithms overclaiming savings, 50% of the savings for 1/8” gap are deemed appropriate. This provides a savings assumption that is similar to the prescriptive Residential door sweep measure in 5.6.1 Air Sealing (assuming 3 ft doorsweep).

4.8.4 C&I Air Sealing

DESCRIPTION

Note- this measure provides a comprehensive approach for various commercial air sealing opportunities. A prescriptive approach for door sweeps only is provided in measure 4.8.16 C&I Weather Stripping.

This Air Sealing Measure incorporates a wide variety of products and procedures that reduce unwanted uncontrolled outdoor air infiltration into commercial or industrial buildings. Unwanted outdoor air causes significant increases in both heating and cooling costs throughout most of the year, and causes unwanted introduction of dust and odors into the building. This outdoor air infiltration is caused by both wind blowing against one or more sides of the building, and also through thermal stack effects in tall buildings that cause infiltration on lower floors and exfiltration on upper floors.

This measure applies to all existing commercial and industrial buildings that utilize mechanical heating and/or cooling to maintain occupant comfort. Identifying the exact length and width of cracks and holes in a building is difficult to do accurately. Similarly, conducting a building pressurization test using multiple blower doors or programming the air handling equipment to pressurize a building is also impractical in most situations. Therefore, this measure's savings calculations are instead based primarily on deemed values of air leakage reduction per unit length or unit area of air sealing retrofits installed.¹⁶⁴⁵ If a blower door or air handler pressurization and measurement test can be done both before and after air sealing, the amount of air cfm reduction, adjusted to 50 pascals of pressure differential, may be directly inserted into the 'Annual Avg infiltration CFM Saved' value to determine annual energy savings.

This measure was developed to be applicable to the following program types: RF

If applied to other program types, the measure savings should be verified.

DEFINITION OF EFFICIENT EQUIPMENT

Air sealing materials and diagnostic testing should meet all eligibility program qualification criteria. If applicable, the initial and final tested leakage rates should be performed in such a manner that the identified reductions can be properly discerned, particularly in situations wherein multiple building envelope measures may be implemented simultaneously.

DEFINITION OF BASELINE EQUIPMENT

The baseline condition of a building upon first inspection significantly impacts the opportunity for cost-effective energy savings through air-sealing.

If applicable and feasible, the existing air leakage rate for an existing building may be determined through approved and appropriate test methods using either blower doors or air handling units programmed to pressurize the building. Outdoor air flow quantities and simultaneous measurements of building differential pressure (inside vs outside) must be measured using approved methods and adjusted to values at 50 pascals differential.

Alternatively, if actual leakage rates cannot be measured, air leakage savings may be deemed using quantities of air leakage lengths or quantities based on inspection of the building. Lengths of cracks to be filled, quantities of leaky doors or windows to be sealed, etc. are documented and prescriptive, deemed savings rates are used to estimate savings.

DEEMED LIFETIME OF EFFICIENT EQUIPMENT

The expected measure life is assumed to be 20 years.¹⁶⁴⁶

¹⁶⁴⁵ ASHRAE, 2001 AHSRAE Handbook – Fundamentals, Chapter 26, Table 1. Effective Air Leakage Areas (Low-Rise Residential Applications Only).

¹⁶⁴⁶ As recommended in Navigant 'ComEd Effective Useful Life Research Report', May 2018.

MEASURE COST

Use actual cost of air sealing measures installed, if available. If actual costs are unknown, use estimated costs from table below multiplied by the number of units of each application installed:

Technology	Application	Unit Definition	Unit Cost Estimate ¹⁶⁴⁷
Weather Stripping	Single Door - Weather Stripping, Sweep	Enter Number of Doors Retrofitted	\$37
	Double Doors - Weather Stripping	Enter Number of Double Door Sets Retrofitted	\$166
	Casement Window - Weather Stripping	Enter Lin. Ft. of Crack Retrofitted	\$5
	Double Horizontal Slider, Wood - Weather Stripping	Enter Lin. Ft. of Crack Retrofitted	\$5
	Double-Hung - Weather Stripping	Enter Lin. Ft. of Crack Retrofitted	\$5
	Double-Hung, with Storm Window - Weather Stripping	Enter Lin. Ft. of Crack Retrofitted	\$5
	Roof-Wall Intersection, Block Seal	Enter Lin. Ft. of Crack Retrofitted	\$10
	Roof-Wall Intersection, Seal Paint	Enter Lin. Ft. of Crack Retrofitted	\$23
	Roof-Wall Intersection, Seal	Enter Lin. Ft. of Crack Retrofitted	\$6
	Piping/Plumbing/Wiring Penetrations - Sealing	Enter Number of Penetrations Retrofitted	\$50
Caulking	Caulking, External Block	Enter Lin. Ft. of Crack Retrofitted	\$12
	Caulking, Internal Seal	Enter Lin. Ft. of Crack Retrofitted	\$6
Attic Sealing	Attic Bypass Air Sealing, Block, Seal	Each	\$386
	Attic Bypass Air Sealing, Seal	Each	\$249
	Retrofit Existing Attic Hatch	Each	\$223
Gasket	Exterior Wall Outlet Penetrations - Gasket	Enter Number of Outlets Retrofitted	\$5
Avg Caulking / Weather Stripping	Average Window/Door Caulking / Weather Stripping	Enter Lin. Ft. of Crack Retrofitted	\$10

LOADSHAPE

- Loadshape C01 – Commercial Electric Cooling
- Loadshape C03 – Commercial Cooling
- Loadshape C04 – Commercial Electric Heating
- Loadshape C05 – Commercial Electric Heating and Cooling
- Loadshape C23 – Commercial Ventilation

COINCIDENCE FACTOR

The summer peak coincidence factor for cooling is provided in two different ways below. The first is used to estimate peak savings during the utility peak hour and is most indicative of actual peak benefits, and the second represents the *average* savings over the defined summer peak period, and is presented so that savings can be bid into PJM’s

¹⁶⁴⁷ Typical project costs from quotation for large commercial air sealing project in Northeast (site: Concord, NH). All unit prices taken from BE Retrofit quote, October 2021.

capacity market. Both values provided are based on analysis of Itron eShape data for Missouri, calibrated to Illinois loads, supplied by Ameren.

$$CF_{SSP} = \text{Summer System Peak Coincidence Factor for Commercial cooling (during system peak hour)} \\ = 91.3\%^{1648}$$

$$CF_{PJM} = \text{PJM Summer Peak Coincidence Factor for Commercial cooling (average during peak period)} \\ = 47.8\%^{1649}$$

Algorithm

CALCULATION OF ENERGY SAVINGS

ELECTRIC ENERGY SAVINGS

$$\Delta kWh = \Delta kWh_{cooling} + \Delta kWh_{heatingElectric} + \Delta kWh_{heatingFurnace}$$

$$\Delta kWh_{cooling} = \text{If building is cooled, reduction in annual cooling requirement due to air sealing} \\ = 1.08 * \text{Infiltration_CFM_Saved} * EFLH_{cooling} * \Delta T_{FL,cooling} / 1000 / \eta_{Cool} * \%Cool$$

$$\Delta kWh_{heatingElectric} = \text{if building is electrically heated, reduction in annual heating requirement due to air sealing} \\ = 1.08 * \text{Infiltration_CFM_Saved} * EFLH_{heating} * \Delta T_{FL,heating} / \eta_{Heat} / 3,412 * \%ElectricHeat$$

$$\Delta kWh_{heatingGas} = \text{If gas furnace or gas boiler heat, kWh savings for reduction in combustion fan run time} \\ = \Delta Therms * F_e * 29.3$$

Where:

$$1.08 = \text{Specific heat of air x density of inlet air @ 70F x 60 min/hr in BTU/hr-F-CFM}$$

$$\text{Infiltration_CFM_Saved} = \text{Annual average CFM of outdoor air infiltration reduced due to air sealing measures implemented}$$

$$= \text{Calculated EITHER by sum of applicable values from table below multiplied by the quantities of each item implemented}^{1650}$$

Technology	Application	Delta CFM50 per Unit	Unit Definition
Weather Stripping	Single Door - Weather Stripping	25.500	Enter Number of Doors Retrofitted
	Double Doors - Weather Stripping	0.730	Enter Sq. Ft. of Both Doors Retrofitted
	Casement Window - Weather Stripping	0.360	Enter Lin. Ft. of Crack Retrofitted
	Double Horizontal Slider, Wood - Weather Stripping	0.473	Enter Lin. Ft. of Crack Retrofitted
	Double-Hung - Weather Stripping	1.618	Enter Lin. Ft. of Crack Retrofitted

¹⁶⁴⁸ Based on analysis of Itron eShape data for Missouri, calibrated to Illinois loads, supplied by Ameren. The AC load during the utility’s peak hour is divided by the maximum AC load during the year.

¹⁶⁴⁹ Based on analysis of Itron eShape data for Missouri, calibrated to Illinois loads, supplied by Ameren. The average AC load over the PJM peak period (1-5pm, M-F, June through August) is divided by the maximum AC load during the year.

¹⁶⁵⁰ ASHRAE, 2001 AHSRAE Handbook – Fundamentals, Chapter 26, Table 1. Effective Air Leakage Areas (Low-Rise Residential Applications Only).

Technology	Application	Delta CFM50 per Unit	Unit Definition
	Double-Hung, with Storm Window - Weather Stripping	0.164	Enter Lin. Ft. of Crack Retrofitted
	Average Caulking Weatherstripping	0.639	Enter Lin. Ft. of Crack Retrofitted
	Piping/Plumbing/Wiring Penetrations - Sealing	10.900	Enter Number of Penetrations Retrofitted
Caulking	Window Framing, Masonry - Caulking	1.364	Enter Sq. Ft. of Windows Retrofitted
	Window Framing, Wood - Caulking	0.382	Enter Sq. Ft. of Windows Retrofitted
	Door Frame, Masonry - Caulking	1.018	Enter Sq. Ft. of Doors Retrofitted
	Door Frame, Wood - Caulking	0.364	Enter Sq. Ft. of Doors Retrofitted
	Average Window/Door - Caulking	0.689	Enter Lin. Ft. of Crack Retrofitted
Avg Caulking / Weather Stripping	Average Window/Door Caulking / Weather Stripping	0.664	Enter Lin. Ft. of Crack Retrofitted
Gasket	Electrical Outlets - Gasket	6.491	Enter Number of Outlets Retrofitted

OR if blower door or total building pressurization measurements have been conducted, by determining the CFM infiltration differential between the existing and efficient building air infiltration rates:

$$= \text{CFM50}_{\text{existing}} - \text{CFM50}_{\text{efficient}}$$

Where:

$\text{CFM50}_{\text{existing}}$ = CFM of Infiltration measured by blower door or by total building pressurization test before air sealing, adjusting measured CFM to equivalent CFM at 50 pascals indoor/outdoor pressure differential¹⁶⁵¹

$\text{CFM50}_{\text{efficient}}$ = Infiltration as measured by blower door or total building pressurization test after air sealing, adjusted to equivalent CFM at 50 pascals pressure differential

$\text{EFLH}_{\text{cooling}}$ = Equivalent Full Load Hours for Cooling [hr] in Existing Buildings or New Construction are provided in Section 4.4, HVAC end use

$\Delta T_{\text{FL,cooling}}$ = Temperature difference [°F] during cooling season between design day outdoor air temperature (T_{DD}) and assumed 55°F base temperature

Climate Zone (City based upon)	$T_{\text{DD,cooling}}$ [°F] ¹⁶⁵²	$\Delta T_{\text{FL,cooling}}$ [°F]
1 (Rockford)	90.9	35.9
2 (Chicago)	91.3	36.3
3 (Springfield)	92.6	37.6
4 (Belleville)	95.2	40.2
5 (Marion)	94.4	39.4

1000 = Conversion of watts to kW

¹⁶⁵¹ 50 Pascals has been established in TRM XXX as the standard building pressure differential for determining average annual infiltration rates; 50 Pascals differential is equivalent to a wind pressure from approximately 10 mph.

¹⁶⁵² Weather Station Data, 0.4% Cooling DB - 2021 ASHRAE Handbook, Fundamentals. The following weather stations were referenced: Climate Zone 1: Chicago Rockford Int'l, Climate Zone 2: Chicago O'Hare Int'l, Climate Zone 3: Abraham Lincoln Capital, Climate Zone 4: Scott AFB, Climate Zone 5: Cape Girardeau Regional.

η_{Cool} = Efficiency of cooling system. Actual, if possible. Alternatively, use IECC 2012 if equipment type is known, or as deemed from table below¹⁶⁵³

Space Cooling / Heating Source	Deemed Cooling EER	Deemed Cooling SEER
No Cooling	N/A	N/A
Unknown Cooling Source	11	13

$\%Cool$ = Percentage of the building that is cooled

$EFLH_{heating}$ = Equivalent Full Load Hours for Heating [hr] in Existing Buildings or New Construction are provided in Section 4.4, HVAC end use

$\Delta T_{FL,heating}$ = Temperature difference [°F] during heating season between design day outdoor air temperature and assumed 55°F heating base temperature

Climate Zone (City based upon)	$T_{DD,heating}$ [°F] ¹⁶⁵⁴	$\Delta T_{FL,heating}$ [°F]
1 (Rockford)	-5.4	60.4
2 (Chicago)	-1.0	56.0
3 (Springfield)	1.1	53.9
4 (Belleville)	7.2	47.8
5 (Marion)	10.1	44.9

η_{Heat} = Efficiency of heating system. Actual, if possible. Alternatively, as deemed from table below:

System Type	Cooling Capacity of Equipment	Age of Equipment	HSPF Estimate	η (Effective COP Estimate) (HSPF/3.413)
Heat Pump ¹⁶⁵⁵	All	Before 2009	6.8	2.0
	< 65,000 Btu/h	2009 - 2017	7.7	2.3
		2017 on	8.2	2.40
	$\geq 65,000$ Btu/h and < 135,000 Btu/h	2010 on	11.3	3.3
	$\geq 135,000$ Btu/h and < 240,000 Btu/h	2010 on	10.9	3.2
$\geq 240,000$ Btu/h and < 760,000 Btu/h	2010 on	10.9	10.9	3.2
Resistance	N/A	N/A	N/A	1
Fossil Fuel Furnace or Boiler	N/A	N/A	N/A	0.8 Thermal Efficiency

¹⁶⁵³ Simplified version of IECC 2012 as a conservative estimate of what is existing.

¹⁶⁵⁴ Weather Station Data, 96.6% Heating DB - 2021 ASHRAE Handbook, Fundamentals. The following weather stations were referenced: Climate Zone 1: Chicago Rockford Int'l, Climate Zone 2: Chicago O'Hare Int'l, Climate Zone 3: Abraham Lincoln Capital, Climate Zone 4: Scott AFB, Climate Zone 5: Cape Girardeau Regional.

¹⁶⁵⁵ Minimum heating efficiency standards for heat pumps are sourced from the Code of Federal Standards for Small and Large Commercial Package Air Conditioning and Heating Equipment (Air Cooled), 10 CFR 431.97 with compliance dates of June 16, 2008; January 1, 2010; January 1, 2017; and January 1, 2018. As the first federal appliance standards for heating efficiency for commercial heat pumps went into effect in June 2008, assuming efficiency standards equivalent to residential heat pumps prior to that date.

- 3,412 = Number of BTUs per kWh
- %ElectricHeat = % of building heated by electricity
- Fe = Furnace Fan energy consumption as a percentage of annual fuel consumption
= 7.7%¹⁶⁵⁶
- 29.3 = kWh per therm (= 100,000 BTU/Therm / 3,412 BTU/kWh)

For example, assuming air conditioned and electric resistance heated mid rise office building with 10 IEER equipment in Rockford: Infiltration_CFM_Saved = 272.8; ηCool = 10.0; %Cool = 100%, ηHeat = 1.0; %ElectricHeat = 100%, then

$$\begin{aligned} \Delta\text{kWh}_{\text{Cooling}} &= 1.08 * 272.8 * 1128 * 35.9 / 1000 / 10 * 100\% \\ &= 1,193 \text{ kWh of cooling energy saved} \\ \Delta\text{kWh}_{\text{Heating}} &= 1.08 * 272.8 * 1,672 * 60.4 / 1.0 / 3,412 * 100\% \\ &= 8,720 \text{ kWh of cooling energy saved} \\ \Delta\text{kWh} &= \Delta\text{kWh}_{\text{cooling}} + \Delta\text{kWh}_{\text{heatingElectric}} + \Delta\text{kWh}_{\text{heatingFurnace}} \\ &= 1,193 + 8,720 + 0 \\ &= 9,913 \text{ kWh} \end{aligned}$$

SUMMER COINCIDENT PEAK DEMAND SAVINGS

$$\Delta\text{kW} = \Delta\text{kWh}_{\text{cooling}} / \text{EFLH}_{\text{cooling}} * \text{CF}$$

Where:

- ΔkWh_cooling = Sum of kWh saved from cooling from above calculations
- EFLH_cooling = Equivalent Full Load Hours for cooling in Existing Buildings are provided in section 4.4 HVAC End Use
- CF_{SSP} = Summer System Peak Coincidence Factor for Commercial cooling (during system peak hour)
= 91.3%¹⁶⁵⁷
- CF_{PJM} = PJM Summer Peak Coincidence Factor for Commercial cooling (average during peak period)
= 47.8%¹⁶⁵⁸

¹⁶⁵⁶ F_e is estimated using TRM models for the three most popular building types for programmable thermostats: low-rise office (10.2%), sit-down restaurant (8.6%), and retail – strip mall (4.4%). 7.7% reflects the average F_e of the three building types. See “Fan Energy Factor Example Calculation 2021-06-23.xlsx” for reference.

¹⁶⁵⁷ Based on analysis of Itron eShape data for Missouri, calibrated to Illinois loads, supplied by Ameren. The AC load during the utility’s peak hour is divided by the maximum AC load during the year.

¹⁶⁵⁸Based on analysis of Itron eShape data for Missouri, calibrated to Illinois loads, supplied by Ameren. The average AC load over the PJM peak period (1-5pm, M-F, June through August) is divided by the maximum AC load during the year.

For example, for an mid rise office in Rockford with air conditioning as defined earlier in this section; assuming:
 = $\Delta kWh_{cooling} = 1200$; $EFLH = 834$; $CF_{SSP} = 0.913$, then

$$\begin{aligned} \Delta kW &= 1193 / 1135 * 0.913 \\ &= 0.96 \text{ kW} \end{aligned}$$

FOSSIL FUEL SAVINGS

If Fossil Fuel heating:

$$\Delta \text{Therms} = 1.08 * \text{Infiltration_CFM_Saved} * EFLH_{heating} * \Delta T_{FL,heating} / \eta_{Heat} / 100,000 * \%FossilHeat$$

Where:

- η_{Heat} = as defined previously
- 100,000 = BTUs per therm
- $\%FossilHeat$ = % of building heated by fossil fuel

For Example, assuming for a mid rise office in Rockford with unknown natural gas heat: $\text{Infiltration_CFM_Saved} = 272.8$; $HDD_{55/yr} = 2284$; $\eta_{Heat} = 0.80$; $\%GasHeat = 100\%$, then

$$\begin{aligned} \Delta \text{ Therms} &= 1.08 * 272.8 * 1672 * 60.4 / 0.80 / 100000 * 100\% \\ &= 372 \text{ Therms} \end{aligned}$$

WATER AND OTHER NON-ENERGY IMPACT DESCRIPTIONS AND CALCULATION

N/A

DEEMED O&M COST ADJUSTMENT CALCULATION

N/A

MEASURE CODE: CI-SHL-CAIR-V04-250101

REVIEW DEADLINE: 1/1/2026

4.8.5 High Speed Overhead Doors

DESCRIPTION

This measure applies to buildings with exterior entryways that utilize overhead doors between heated and/or air conditioned spaces and the outdoors that see a high amount of traffic on a daily basis. High speed doors for refrigerated spaces are covered in section 4.6.10 of the TRM. All other high speed door applications, such as conventional foot-traffic entryways, require custom analysis.

The use of overhead doors within exterior entryways during the heating season leads to the exfiltration of warm air from the upper portion of the door opening and the infiltration of colder air from the lower portion of the door opening. This results in increased heating energy use to compensate for heat losses every time a door is opened. By reducing the time it takes for the door to open and close, high speed doors can also enhance the physical comfort of employees or customers near the entryway as there will be reduced temperature fluctuations when the door is opened and closed. In addition, in some cases excess heating capacity may be installed in buildings to meet this larger heating load. The addition of high speed doors to exterior entryways that currently utilize standard overhead doors will result in energy savings and enhanced personal comfort, and also possibly in reduced equipment sizing and associated costs.

The primary markets for this measure are commercial and industrial facilities with overhead doors in exterior entryways, including but not limited to the following building types: manufacturing, warehouse (non-refrigerated), vehicle maintenance facilities, and enclosed/heated commercial or multifamily parking garages.

This measure was developed to be applicable to the following program types: NC, RF. If applied to other program types, the measure savings should be verified.

DEFINITION OF EFFICIENT EQUIPMENT

To qualify for this measure the installed equipment must be a High Speed Door installed at a loading dock or drive-in door for a heated and/or cooled warehouse, manufacturing, service garage, or similar space. Heating can be gas fired or electric heat pump. Doors which have a refrigerated space on the interior should use measure 4.6.10 for High Speed Rollup Doors. Doors separating interior spaces with different temperature setpoints on either side are not eligible.

High speed doors must have a minimum opening speed of 32 inches per second and a minimum closing speed of 24 inches per second¹⁶⁵⁹.

DEFINITION OF BASELINE EQUIPMENT

The baseline equipment is a standard overhead door, which is generally estimated to have an opening and closing speed of around 8 inches per second¹⁶⁶⁰. The doorway should not have any type of existing open-doorway protection such as strip curtains or air curtains.

DEEMED LIFETIME OF EFFICIENT EQUIPMENT

The expected measure life is assumed to be 16 years.¹⁶⁶¹

DEEMED MEASURE COST

The incremental measure cost is \$105/sqft.¹⁶⁶²

¹⁶⁵⁹ DASMA Standard 403-2020, "Specification for High Speed Doors and Grilles", DASMA Standard (2020): Section 2.6.

¹⁶⁶⁰ Wendt, Jeff, "When a High-Speed Door is More Energy Efficient", Door & Access Systems Magazine – Tech Tips. September 2014.

¹⁶⁶¹ Assumed same measure life as high speed rollup doors for refrigerated spaces (4.6.10); As recommended in Navigant 'ComEd Effective Useful Life Research Report', May 2018.

¹⁶⁶² The incremental cost is derived from analysis of a set of PG NSG custom project data, and based on equipment quotes in 2021.

LOADSHAPE

Heating Season: If electric heating, use Commercial Electric Heating Loadshape: C04. Otherwise, N/A

Cooling Season: Commercial Cooling Loadshape C03. Or, if applicable, use Commercial Electric Heating and Cooling Loadshape C05.

COINCIDENCE FACTOR

- CF_{SSP} = Summer System Peak Coincidence Factor for Commercial cooling (during system peak hour)
= 91.3%¹⁶⁶³
- CF_{PJM} = PJM Summer Peak Coincidence Factor for Commercial cooling (average during peak period)
= 47.8%¹⁶⁶⁴

Algorithm

CALCULATION OF ENERGY SAVINGS

The following formulas provide a methodology for estimating cooling load (kWh) and heating load (therm) savings associated with the installation of a high speed overhead door on exterior entryways such as a single door or loading bay. This algorithm is based on the assumption that savings are directly related to the difference in cooling or heating losses due to infiltration or exfiltration through an entryway before and after the installation of the high speed door. Energy savings are assumed to be the result of a reduction of natural infiltration effects due to wind and thermal forces and follow the calculation methodology outlined by the ASHRAE Handbook.¹⁶⁶⁵

This algorithm allows either actual inputs or provides estimates if actual data is not available. All weather dependent values are derived from TMY3 data for the closest weather station to those locations defined elsewhere in the Illinois TRM (which are based on 30 year climate normals). If TMY3 weather station data was not available for the data used in the Illinois TRM, the next closest weather station was used. It is assumed that weather variations are negligible between the weather stations located within the same region. This approach was followed as the high speed door algorithm has a number of weather dependent variables, which are all calculated in relation to the heating season or cooling season as defined by the balance point temperature deemed appropriate for the facility. All weather dependent data is based on TMY3 data and is listed in tables by both climate zone and balance point temperature, which is then normalized to the Illinois TRM climate zoned HDD/CDD definitions unless otherwise noted.

ELECTRIC ENERGY SAVINGS

$$\Delta kWh_{cooling} = (Q / EER) * (t_{standard} - t_{fast}) * CD$$

$$\Delta kWh_{HPheating} = (Q / HSPF) * (t_{standard} - t_{fast}) * HD$$

Where:

- Q = rate of total heat transfer through the open entryway (kBtu/hr)
(see calculation in ‘Heat Transfer Through Open Entryway’ section below)
- EER = energy efficiency ratio of the cooling equipment (kBtu/kWh)
= Actual. If unknown, use the table C403.2.3(2) in IECC 2012 (or IECC 2018 if through new construction) to assume values based on code estimates.

¹⁶⁶³ Based on analysis of Itron eShape data for Missouri, calibrated to Illinois loads, supplied by Ameren. The AC load during the utility’s peak hour is divided by the maximum AC load during the year.

¹⁶⁶⁴ Based on analysis of Itron eShape data for Missouri, calibrated to Illinois loads, supplied by Ameren. The average AC load over the PJM peak period (1-5pm, M-F, June through August) is divided by the maximum AC load during the year.

¹⁶⁶⁵ ASHRAE, “Ventilation and Infiltration,” in 2013 ASHRAE Handbook – Fundamentals (2013): Ch 16.1 - 16.37.

Note IECC 2018 became effective July 1, 2019 and is the baseline for all New Construction permits from that date.

t_{standard} = average hours per day the standard speed door is open (hr/day)

(see calculation in ‘Time door is open’ section below)

t_{fast} = average hours per day the high speed door is open (hr/day)

(see calculation in ‘Time door is open’ section below)

CD = cooling days per year, total days in year above balance point temperature (day)

= use table below to select the best value for location:¹⁶⁶⁶

Climate Zone -Weather Station/City	CD (Balance Point Temperature)				
	45 °F	50 °F	55 °F	60 °F	65 °F
1 - Rockford AP / Rockford	194	168	148	124	97
2 - Chicago O'Hare AP / Chicago	194	173	153	127	95
3 - Springfield #2 / Springfield	214	194	174	148	114
4 - Belleville SIU RSCH / Belleville	258	229	208	174	138
5 - Carbondale Southern IL AP / Marion	222	201	181	158	130

HSPF = Heating System Performance Factor of heat pump equipment

= Actual. If unknown, use the table C403.2.3(2) in IECC 2012 (or IECC 2018 if through new construction) to assume values based on code estimates.

Note IECC 2018 became effective July 1, 2019 and is the baseline for all New Construction permits from that date.

HD = heating days per year, total days in year above balance point temperature (day)

= use table below to select an appropriate value:¹⁶⁶⁷

Climate Zone Weather Station/City	HD				
	45 °F	50 °F	55 °F	60 °F	65 °F
1 - Rockford AP / Rockford	142	160	183	204	228
2 - Chicago O'Hare AP / Chicago	150	166	192	219	253
3 - Springfield #2 / Springfield	125	142	167	194	230
4 - Belleville SIU RSCH / Belleville	101	115	134	156	180
5 - Carbondale Southern IL AP / Marion	103	123	148	174	205

Time Door is Open

t_{standard} = $\text{CyclesPerDay} * [H_d * 12 * (1 / \text{Speed}_{\text{open_standard}} + 1 / \text{Speed}_{\text{close_standard}})] / 3600$

t_{fast} = $\text{CyclesPerDay} * [H_d * 12 * (1 / \text{Speed}_{\text{open_fast}} + 1 / \text{Speed}_{\text{close_fast}})] / 3600$

¹⁶⁶⁶ National Solar Radiation Data Base – 1991 – 2005 Update: Typical Meteorological Year 3, NREL. Note that cooling days (CD) are calculated by first determining its value from the TMY3 data associated with the appropriate weather station as defined by and used elsewhere in the Illinois TRM. Using the TMY3 outdoor air dry bulb hourly data, the annual hours are totaled for every hour that the outdoor air dry bulb temperature is above a designated zero heat loss balance point temperature or base temperature for cooling. For commercial and industrial (C&I) buildings, a base temperature for heating of 55 oF is designated in the Illinois TRM, but building specific base temperatures are recommended for large C&I projects. Additionally, the TRM uses a 30-year normal data for degree-days while the CD calculation was based on TMY3 data; in order to account for this, calculations of CD were also normalized by the ratio of CDD to align the calculated values more closely with the TRM.

¹⁶⁶⁷ Note that Heating Days (HD) are calculated following the same approach outlined in the Cooling Days section.

Where:

- CyclesPerDay = the number of door opening and closing cycles per day
= Actual. If unknown, use 75¹⁶⁶⁸ or for parking garages calculate based on the number of parking spaces¹⁶⁶⁹.
- H_d = the height of the doorway (ft)
= user input
- 12 = unit conversion from feet to inches
- Speed_{open} = the speed (inches/second) at which the door opens
= Actual. If unknown, use 32 inches/second for high speed¹⁶⁷⁰, use 8 inches/second for standard speed¹⁶⁷¹
- Speed_{close} = the speed (inches/second) at which the door closes
= Actual. If unknown, use 24 inches/second for high speed¹⁶⁷², = 8 inches/second for standard speed¹⁶⁷³
- 3600 = unit conversion from seconds to hours

Heat Transfer Through Open Entryway (Cooling Season)

$Q = 4.5 * CFM_{tot} * (h_{oc} - h_{ic}) / (1,000 \text{ Btu/kBtu})$

Where:

- 4.5 = unit conversion factor with density of air: 60 min/hr * 0.075 lbm/ft³ (lb*min/(ft*hr))
- CFM_{tot} = Total air flow through entryway (cfm), see calculation below
- h_{oc} = average enthalpy of outside air during the cooling season (Btu/lb)
= use the below table to determine the approximate outdoor air enthalpy associated with an indoor temperature setpoint and climate zone.¹⁶⁷⁴

Climate Zone -Weather Station/City	h _{oc}		
	67 °F	72 °F	77 °F
1 - Rockford AP / Rockford	31.6	33.0	35.3
2 - Chicago O'Hare AP / Chicago	32.0	33.6	35.4
3 - Springfield #2 / Springfield	32.9	34.6	36.6
4 - Belleville SIU RSCH / Belleville	33.5	35.0	36.4
5 - Carbondale Southern IL AP / Marion	34.6	36.2	37.7

¹⁶⁶⁸ Wendt, Jeff, "When a High-Speed Door is More Energy Efficient", Door & Access Systems Magazine – Tech Tips. Sept. 2014.

¹⁶⁶⁹ ASHRAE, "Enclosed Vehicular Facilities – Parking Garages," in 2019 ASHRAE Handbook – HVAC Applications (2019): p. 16.18 to 16.20. Number of cars operating is 3-5% (use 4% as average) per hour of the total vehicle capacity, making openings per day = 4% * number of parking spaces * 24 hours per day * 2 (car will enter and leave once per day).

¹⁶⁷⁰ DASMA Standard 403-2020, "Specification for High Speed Doors and Grilles", DASMA Standard (2020): Section 2.6.

¹⁶⁷¹ Wendt, Jeff, "When a High-Speed Door is More Energy Efficient", Door & Access Systems Magazine – Tech Tips. Sept. 2014.

¹⁶⁷² DASMA Standard 403-2020, "Specification for High Speed Doors and Grilles", DASMA Standard (2020): Section 2.6.

¹⁶⁷³ Wendt, Jeff, "When a High-Speed Door is More Energy Efficient", Door & Access Systems Magazine – Tech Tips. Sept. 2014.

¹⁶⁷⁴ Average enthalpies were estimated following ASHRAE guidelines for perfect gas relationships for dry air associated with hourly TMY3 data. Enthalpies were then averaged for all values associated with a dry-bulb outdoor air temperature that exceeded the indoor air temperature setpoint. Other enthalpy values may be interpolated for indoor air temperature setpoints not represented in the table. Note that while outdoor air enthalpies increase with higher temperature setpoints, the change in enthalpy from indoor to outdoor will decrease.

h_{ic} = average enthalpy of indoor air, cooling season (Btu/lb)

= use the below table to determine the approximate indoor air enthalpy associated with an indoor temperature setpoint in indoor relative humidity.

Relative Humidity (%)	h_{ic}		
	67 °F	72 °F	77 °F
60	25.5	28.5	31.8
50	23.9	26.6	29.5
40	22.3	24.7	27.3

= an estimate 26.6 Btu/lb associated with the 72 °F and 50% indoor relative humidity case can be used as an approximation if no other data is available. For other indoor temperature setpoints and RH, enthalpies may be interpolated.

The total airflow through the entryway, CFM_{tot} , includes both infiltration due to wind as well as thermal forces, as follows:

$$CFM_{tot} = \text{sqrt} [(CFM_w)^2 + (CFM_t)^2]$$

Where:

CFM_w = Infiltration due to the wind (cfm)

CFM_t = Infiltration due to thermal forces (cfm)

The infiltration due to the wind is calculated as follows:

$$CFM_w = (v_{wc} * C_{wc}) * C_v * A_d * (88 \text{ fpm/mph})$$

Where:

v_{wc} = average wind speed during the cooling season based on entryway orientation (mph)

= use the below table to for the wind speed effects based on climate zone and entryway orientation:¹⁶⁷⁵

Climate Zone -Weather Station /City	Entryway Orientation				
	N	E	S	W	Unknown (average)
1 - Rockford AP / Rockford	4.2	4.1	4.7	4.8	4.5
2 - Chicago O'Hare AP / Chicago	4.7	4.5	5.4	4.6	4.8
3 - Springfield #2 / Springfield	4.1	3.7	6.0	5.0	4.7
4 - Belleville SIU RSCH / Belleville	3.3	2.7	3.8	4.2	3.5
5 - Carbondale Southern IL AP / Marion	3.1	2.9	4.4	3.8	3.6

¹⁶⁷⁵ Average wind speeds are calculated based on the TMY3 wind speed data. Because this data is collected at an altitude of 33 ft, wind speed is approximated for a 5 ft level based on ASHRAE Handbook guidelines using the urban/suburban parameters for adjusting wind speed based on altitude (Layer thickness (ft) $\delta = 1200$, Exponent $a = 0.22$). ASHRAE, "Airflow Around Buildings," in 2013 ASHRAE Handbook – Fundamentals (2013): p 24.3.

C_{wc} = wind speed correction factor due to wind direction in cooling season (%)

= because wind direction is not constant, a wind speed correction factor is used to adjust for the amount of time during the cooling season prevailing winds can be expected to impact the entryway. Use the following table to determine the correct wind speed correction factor for cooling applications.

Climate Zone -Weather Station/City	Entryway Orientation				
	N	E	S	W	Unknown (Average)
1 - Rockford AP / Rockford	0.18	0.13	0.30	0.31	0.23
2 - Chicago O'Hare AP / Chicago	0.18	0.17	0.36	0.26	0.24
3 - Springfield #2 / Springfield	0.17	0.12	0.46	0.21	0.24
4 - Belleville SIU RSCH / Belleville	0.21	0.15	0.35	0.16	0.22
5 - Carbondale Southern IL AP / Marion	0.18	0.15	0.37	0.11	0.20

Note that correction factors do not add up to 1 (100%). This is attributed to periods of calm winds.

C_v = effectiveness of openings,
= 0.3, assumes diagonal wind¹⁶⁷⁶

A_d = area of the doorway (ft²)
= user defined

The infiltration due to thermal forces is calculated as follows:

$$CFM_t = A_d * C_{dc} * (60 \text{ sec/min}) * \text{sqrt}[2 * g * H_d/2 * (T_{oc} - T_{ic}) / (459.7 + T_{oc})]$$

Where:

C_{dc} = the discharge coefficient during the cooling season¹⁶⁷⁷
= $0.4 + 0.0025 * |T_{ic} - T_{oc}|$

Note, values for C_{dc} show little variation due to balance point temperature, indoor air temperature, and climate zone. As such, if estimating results, the Illinois average value of 0.42 at indoor air temp of 72°F may be used as a simplification.

g = acceleration due to gravity
= 32.2 ft/sec²

T_{ic} = Average indoor air temperature during cooling season
= User input, can assume indoor cooling temperature set-point

T_{oc} = Average outdoor temp during cooling season (°F)
= the average outdoor temperature is dependent on the CD period and zone. As such, the following table may be used for average outdoor temperature during the cooling period:¹⁶⁷⁸

¹⁶⁷⁶ ASHRAE, "Ventilation and Infiltration," in 2013 ASHRAE Handbook – Fundamentals (2013): p 16.13

¹⁶⁷⁷ ASHRAE, "Ventilation and Infiltration," in 2013 ASHRAE Handbook – Fundamentals (2013): p 16.13.

¹⁶⁷⁸ Based on binned data from TMY3 & adjusted bracketed thermostat setpoint temperatures. Interpolate other values as needed.

Climate Zone Weather Station/City	T _{oc}				
	62 °F	67 °F	72 °F	77 °F	82 °F
1 - Rockford AP / Rockford	72.9	76.0	79.2	82.5	85.5
2 - Chicago O'Hare AP / Chicago	72.9	76.0	79.4	82.8	85.5
3 - Springfield #2 / Springfield	73.7	76.7	79.9	83.4	86.4
4 - Belleville SIU RSCH / Belleville	74.9	77.7	81.0	84.3	86.9
5 - Carbondale Southern IL AP / Marion	75.1	77.7	80.9	84.7	87.4

459.7 = conversion factor from °F to °R

= calculation requires absolute temperature for values not calculated as a difference of temperatures.

SUMMER COINCIDENT PEAK DEMAND SAVINGS

$$\Delta kW = (\Delta kWh_{cooling} / (CD * 24)) * CF$$

Where:

CF_{SSP} = Summer System Peak Coincidence Factor for Commercial cooling (during system peak hour)
 = 91.3%¹⁶⁷⁹

CF_{PJM} = PJM Summer Peak Coincidence Factor for Commercial cooling (average during peak period)
 = 47.8%¹⁶⁸⁰

FOSSIL FUEL SAVINGS

Natural gas savings, Δtherms, associated with reduced infiltration through an entryway during the heating season are calculated by determining the difference between heat loss through the entryway before and after the installation of the high speed overhead door.

$$\Delta thermos = Q * (t_{standard} - t_{fast}) * HD / \eta$$

Where:

Q = rate of sensible heat transfer through the open entryway, before air curtain (therm/hr)

t_{standard} = average hours per day the standard speed door is open (hr/day)
 (see calculation in 'Time door is open' heading of Electric Energy Savings section)

t_{fast} = average hours per day the high speed door is open (hr/day)
 (see calculation in 'Time door is open' heading of Electric Energy Savings section)

HD = heating days per year, total days in year above balance point temperature (day)
 = use table below to select an appropriate value:¹⁶⁸¹

Climate Zone - Weather Station/City	HD				
	45 °F	50 °F	55 °F	60 °F	65 °F
1 - Rockford AP / Rockford	142	160	183	204	228
2 - Chicago O'Hare AP / Chicago	150	166	192	219	253

¹⁶⁷⁹ Based on analysis of Itron eShape data for Missouri, calibrated to Illinois loads, supplied by Ameren. The AC load during the utility's peak hour is divided by the maximum AC load during the year.

¹⁶⁸⁰ Based on analysis of Itron eShape data for Missouri, calibrated to Illinois loads, supplied by Ameren. The average AC load over the PJM peak period (1-5pm, M-F, June through August) is divided by the maximum AC load during the year

¹⁶⁸¹ Note that Heating Days (HD) are calculated following the same approach outlined in the Cooling Days section.

Climate Zone - Weather Station/City	HD				
	45 °F	50 °F	55 °F	60 °F	65 °F
3 - Springfield #2 / Springfield	125	142	167	194	230
4 - Belleville SIU RSCH / Belleville	101	115	134	156	180
5 - Carbondale Southern IL AP / Marion	103	123	148	174	205

η = efficiency of heating equipment
 = Actual. If unknown, assume 0.8

Heat Transfer Through Open Entryway (Heating Season)

$$Q = 1.08 * CFM_{tot} * (T_{ih} - T_{oh}) / (100,000 \text{ Btu/therm})$$

Where:

- 1.08 = sensible heat transfer coefficient: specific heat of air and unit conversions, Btu/(hr*°F*cfm)
- CFM_{tot} = Total air flow through entryway (cfm)
- T_{ih} = Average indoor air temperature during heating season
 = User input, can assume indoor heating temperature set-point
- T_{oh} = Average outdoor temp during heating season (°F)
 = use table below, based on binned data from TMY3 & balance point temperature:

Climate Zone -Weather Station/City	Avg Outdoor Air Temp - Heating Season				
	45 °F	50 °F	55 °F	60 °F	65 °F
1 - Rockford AP / Rockford	26.3	28.8	31.6	34.2	37.3
2 - Chicago O'Hare AP / Chicago	29.4	31.2	34.0	36.8	40.3
3 - Springfield #2 / Springfield	29.4	31.5	34.6	37.7	41.6
4 - Belleville SIU RSCH / Belleville	31.7	33.6	36.2	39.2	42.3
5 - Carbondale Southern IL AP / Marion	32.5	34.9	37.8	40.7	44.0

The total airflow through the entryway, CFM_{tot}, includes both infiltration due to wind as well as thermal forces, as follows:

$$CFM_{tot} = \text{sqrt}[(CFM_w)^2 + (CFM_t^2)]$$

Where:

- CFM_w = Infiltration due to the wind (cfm)
- CFM_t = Infiltration due to thermal forces (cfm)

The infiltration due to the wind is calculated as follows:

$$CFM_w = (v_{wh} * C_{wh}) * C_v * A_d * (88 \text{ fpm/mph})$$

Where:

- v_{wh} = average wind speed during the heating season (mph)
 = similar to cooling season wind speed assumptions, use the following table to determined average wind speed based on entryway orientation:

Climate Zone -Weather Station/ City	Entryway Orientation			
	N	E	S	W
1 - Rockford AP / Rockford	5.0	4.6	4.9	5.6

	Entryway Orientation			
2 - Chicago O'Hare AP / Chicago	5.5	5.2	4.9	5.1
3 - Springfield #2 / Springfield	5.0	4.9	5.3	5.1
4 - Belleville SIU RSCH / Belleville	4.3	3.4	3.5	5.3
5 - Carbondale Southern IL AP / Marion	4.6	3.2	4.2	4.4

C_{wh} = wind speed correction factor due to wind direction in heating season, (%)
 = because wind direction is not constant, a wind speed correction factor is used to adjust for the amount of time during the heating season prevailing winds can be expected to impact the entryway. Use the following table to determine the correct wind speed correction factor for the heating applications.

	Entryway Orientation			
Climate Zone -Weather Station/ City	N	E	S	W
1 - Rockford AP / Rockford	0.18	0.13	0.30	0.31
2 - Chicago O'Hare AP / Chicago	0.21	0.10	0.26	0.39
3 - Springfield #2 / Springfield	0.21	0.14	0.27	0.34
4 - Belleville SIU RSCH / Belleville	0.31	0.15	0.22	0.29
5 - Carbondale Southern IL AP / Marion	0.31	0.11	0.27	0.18

Note that correction factors do not add up to 1 (100%). This is attributed to periods of calm winds.

C_v = effectiveness of openings,
 = 0.3, assumes diagonal wind¹⁶⁸²

A_d = area of the doorway (ft²)
 = user input

The infiltration due to thermal forces is calculated as follows:

$$CFM_t = A_d * C_{dh} * (60 \text{ sec/min}) * \text{sqrt}[2 * g * H/2 * (T_{ih} - T_{oh}) / (459.7 + T_{ih})]$$

Where:

C_{dh} = the discharge coefficient during the heating season
 = $0.4 + 0.0025 * |T_{ih} - T_{oh}|$

Note, values for C_{dh} show little variation due to balance point temperature, indoor air temperature, and climate zone. As such, if estimating results, the Illinois average value of 0.49 at indoor air temp of 72°F may be used as a simplification.

g = acceleration due to gravity
 = 32.2 ft/sec²

H = the height of the entryway (ft)
 = user defined

WATER AND OTHER NON-ENERGY IMPACT DESCRIPTIONS AND CALCULATION

N/A

¹⁶⁸² ASHRAE, "Ventilation and Infiltration," in 2013 ASHRAE Handbook – Fundamentals (2013): p 16.13

DEEMED O&M COST ADJUSTMENT CALCULATION

Manufacturers suggest annual inspection and maintenance (such as patching tears) of high speed doors. At a minimum, greasing of fittings and oil top-off should be carried out annually. This is estimated at a cost of \$150 per year.¹⁶⁸³

MEASURE CODE: CI-SHL-HSOD-V01-230101

REVIEW DEADLINE: 1/1/2026

¹⁶⁸³Assumes approximately 1 hour of maintenance, based on manufacturer product spec sheets.

4.8.6 Dock Door Seals and Shelter

DESCRIPTION

This measure applies to buildings with exterior doors that serve as loading docks.

Overhead dock doors allow for loading and unloading of trucks. When the truck backs into the dock bumpers, a gap is created between the truck and the dock door that allows the infiltration or exfiltration of air in the upper, lower, and side portions. The infiltration/exfiltration of cold and warm air during the heating and cooling seasons increases the energy load of the building. Dock door seals are foam panels that are mounted outside of the dock door. Dock shelters are structures that form an enclosure around the perimeter of the trailer and are mounted outside of the dock door. The addition of dock door seals and shelters forms a tight seal between the truck and the door that prevents air infiltration/exfiltration and results in energy savings and enhanced personal comfort. Dock door seals and shelters also prevent the passing of rain droplets, snow, dust, insects, and other airborne particles.

This measure was developed to be applicable to the following program types: RF. If applied to other program types, the measure savings should be verified.

DEFINITION OF EFFICIENT EQUIPMENT

Dock doors with compression seals or shelters forming a tight seal around the top, bottom, and sides of the truck and installed following manufacturer guidelines to effectively reduce heat loss and air during truck loading and unloading.

DEFINITION OF BASELINE EQUIPMENT

Dock doors with no seals or shelters installed to effectively reduce heat loss and air during truck loading and unloading.

DEEMED LIFETIME OF EFFICIENT EQUIPMENT

The expected measure life is assumed to be 15 years¹⁶⁸⁴.

DEEMED MEASURE COST

The capital cost for dock door seals for exterior entryways is \$3,692¹⁶⁸⁵.

LOADSHAPE

Heating season: If electric heating, use Commercial Electric heating Loadshape, C04. Otherwise, N/A

Cooling seasons: Commercial Cooling Loadshape C03. Or, if applicable, use Commercial Electric Heating and Cooling Loadshape C05.

COINCIDENCE FACTOR

CF_{SSP} = Summer System Peak Coincidence Factor for Commercial cooling (during system peak hour)
 = 91.3%¹⁶⁸⁶

CF_{PJM} = PJM Summer Peak Coincidence Factor for Commercial cooling (average during peak period)

¹⁶⁸⁴ California Statewide Codes and Standards Enhancement (CASE) Program. "Dock Seals – Final Report". California, November 2017.

¹⁶⁸⁵ Based on average project cost for dock door shelters incentivized under PG NSG Energy Efficiency programs between 2018 and 2020. Shelter average size is 85 square feet.

¹⁶⁸⁶ Based on analysis of Itron eShape data for Missouri, calibrated to Illinois loads, supplied by Ameren. The AC load during the utility's peak hour is divided by the maximum AC load during the year.

$$= 47.8\%^{1687}$$

Algorithm

CALCULATION OF ENERGY SAVINGS

The formulas follow the calculation methodology outlined by the ASHARE Handbook¹⁶⁸⁸ as stated in measure 4.4.33 Industrial Air Curtains.

ELECTRIC ENERGY SAVINGS

$$\Delta kWh_{cooling} = Q_{tbs} * t_{open} * CD / EER$$

$$\Delta kWh_{heating} = Q_{bs} * t_{open} * HD * (100 \text{ kBtu/therm}) / (HSPF * (3.412 \text{ kBtu/kWh}))$$

Where:

Q_{tbs} = rate of total heat transfer through the gap before dock door seal or shelter [kBtu/hr]

t_{open} = average hours per day that a truck is in the loading position and the truck dock door is open [hr/day]

= 8.39 hours¹⁶⁸⁹ or actual.

CD = cooling days per year, total days in year above balance point temperature (day)

= use table below to select the best value for location, or 55°F if unknown:¹⁶⁹⁰

Climate Zone -Weather Station/City	CD (Balance Point Temperature)				
	45°F	50°F	55°F	60°F	65°F
1 - Rockford AP / Rockford	194	168	148	124	97
2 - Chicago O'Hare AP / Chicago	194	173	153	127	95
3 - Springfield #2 / Springfield	214	194	174	148	114
4 - Belleville SIU RSCH / Belleville	258	229	208	174	138
5 - Carbondale Southern IL AP / Marion	222	201	181	158	130

EER = energy efficiency ratio of the cooling equipment (kBtu/kWh)

= Actual. If unknown, use the table C403.2.3(2) in IECC 2012 (or IECC 2018 if through new construction) to assume values based on code estimates.

HSPF = Heating System Performance Factor of heat pump equipment

¹⁶⁸⁷ Based on analysis of Itron eShape data for Missouri, calibrated to Illinois loads, supplied by Ameren. The average AC load over the PJM peak period (1-5pm, M-F, June through August) is divided by the maximum AC load during the year.

¹⁶⁸⁸ ASHRAE, "Ventilation and Infiltration," in 2013 ASHRAE Handbook – Fundamentals (2013): Ch 16.1 - 16.37.

¹⁶⁸⁹ Assumes 23-hour per day operation 5 days per week, with an average loading time of 45 minutes (including truck arrival and departure time) taken from: <https://www.novalocks.com/wp-content/uploads/Dock-Planning-Standards-Guide.pdf>. Average time between trucks estimated at 90 minutes taken from customer interviews. 5 day/7 days * 23 hr/day / 90 minutes per truck event x 45 minutes door open time per truck event = 8.39 average hr/day, 7 days/week.

¹⁶⁹⁰ National Solar Radiation Data Base – 1991 – 2005 Update: Typical Meteorological Year 3, NREL.

Note that cooling days (CD) are calculated by first determining its value from the TMY3 data associated with the appropriate weather station as defined by and used elsewhere in the Illinois TRM. Using the TMY3 outdoor air-dry bulb hourly data, the annual hours are totaled for every hour that the outdoor air-dry bulb temperature is above a designated zero heat loss balance point temperature or base temperature for cooling. For commercial and industrial (C&I) buildings, a base temperature for heating of 55°F is designated in the Illinois TRM, but building specific base temperatures are recommended for large C&I projects. Additionally, the TRM uses a 30-year normal data for degree-days while the CD calculation was based on TMY3 data; in order to account for this, calculations of CD were also normalized by the ratio of CDD to align the calculated values more closely with the TRM.

= Actual. If unknown, use the table C403.2.3(2) in IECC 2012 (or IECC 2018 if through new construction) to assume values based on code estimates.

HD = heating days per year, total days in year above balance point temperature [day]

= use table below to select an appropriate value, or 55°F if unknown:¹⁶⁹¹

Climate Zone Weather Station/City	HD				
	45°F	50°F	55°F	60°F	65° F
1 - Rockford AP / Rockford	142	160	183	204	228
2 - Chicago O'Hare AP / Chicago	150	166	192	219	253
3 - Springfield #2 / Springfield	125	142	167	194	230
4 - Belleville SIU RSCH / Belleville	101	115	134	156	180
5 - Carbondale Southern IL AP / Marion	103	123	148	174	205

Heat Transfer Through Open Dock Door Without Dock Door Seal or Shelter (during Cooling Season)

$Q_{tbs} = 4.5 * CFM_{tot} * (h_{oc} - h_{ic}) / (1,000 \text{ Btu/kBtu})$

4.5 = unit conversion factor with density of air: 60min/hr * 0.075 lbm/ft³ (lbm * min / (ft³ * hr))

CFM_{tot} = total air flow through dock door (CFM)

h_{oc} = average enthalpy of outside air during the cooling season (Btu/lb)

= use the below table to determine the approximate outdoor air enthalpy associated with an indoor temperature setpoint and climate zone, use 72°F if unknown.¹⁶⁹²

Climate Zone -Weather Station/City	h _{oc}		
	67°F	72°F	77°F
1 - Rockford AP / Rockford	31.6	33.0	35.3
2 - Chicago O'Hare AP / Chicago	32.0	33.6	35.4
3 - Springfield #2 / Springfield	32.9	34.6	36.6
4 - Belleville SIU RSCH / Belleville	33.5	35.0	36.4
5 - Carbondale Southern IL AP / Marion	34.6	36.2	37.7

h_{ic} = average enthalpy of indoor air, cooling season (Btu/lb) point temperature

= use the below table to determine the approximate indoor air enthalpy associated with an indoor temperature setpoint in indoor relative humidity.

Relative Humidity (%)	h _{ic}		
	67°F	72°F	77°F
60	25.5	28.5	31.8
50	23.9	26.6	29.5
40	22.3	24.7	27.3

= an estimate 26.6 Btu/lb associated with the 72°F and 50% indoor relative humidity case can be

¹⁶⁹¹ Note that Heating Days (HD) are calculated following the same approach outlined in the Cooling Days section.

¹⁶⁹² Average enthalpies were estimated following ASHRAE guidelines for perfect gas relationships for dry air associated with hourly TMY3 data. Enthalpies were then averaged for all values associated with a dry-bulb outdoor air temperature that exceeded the indoor air temperature setpoint. Other enthalpy values may be interpolated for indoor air temperature setpoints not represented in the table. Note that while outdoor air enthalpies increase with higher temperature setpoints, the change in enthalpy from indoor to outdoor will decrease.

used as an approximation if no other data is available. For other indoor temperature setpoints and RH, enthalpies may be interpolated.

The total airflow through the gaps, CFM_{tot}, includes both infiltration due to wind as well as thermal forces, as follows:

$$CFM_{tot} = \text{sqrt}[(CFM_w)^2 + (CFM_t^2)]$$

Where:

CFM_w = Infiltration due to the wind (cfm)

CFM_t = Infiltration due to thermal forces (cfm)

The infiltration due to the wind is calculated as follows:

$$CFM_w = (v_{wc} * C_{wc}) * C_v * L_a * (88 \text{ fpm/mph})$$

Where:

v_{wc} = average wind speed during the cooling season based on entryway orientation (mph)

= use the below table to for the wind speed effects based on climate zone and entryway orientation:¹⁶⁹³

Climate Zone -Weather Station /City	Entryway Orientation				
	N	E	S	W	Unknown (average)
1 - Rockford AP / Rockford	4.2	4.1	4.7	4.8	4.5
2 - Chicago O'Hare AP / Chicago	4.7	4.5	5.4	4.6	4.8
3 - Springfield #2 / Springfield	4.1	3.7	6.0	5.0	4.7
4 - Belleville SIU RSCH / Belleville	3.3	2.7	3.8	4.2	3.5
5 - Carbondale Southern IL AP / Marion	3.1	2.9	4.4	3.8	3.6

C_{wc} = wind speed correction factor due to wind direction in cooling season (%)

= because wind direction is not constant, a wind speed correction factor is used to adjust for the amount of time during the cooling season that prevailing winds can be expected to impact the entryway. Use the following table to determine the correct wind speed correction factor for cooling applications.

Climate Zone -Weather Station/City	Entryway Orientation				
	N	E	S	W	Unknown (Average)
1 - Rockford AP / Rockford	0.18	0.13	0.30	0.31	0.23
2 - Chicago O'Hare AP / Chicago	0.18	0.17	0.36	0.26	0.24
3 - Springfield #2 / Springfield	0.17	0.12	0.46	0.21	0.24
4 - Belleville SIU RSCH / Belleville	0.21	0.15	0.35	0.16	0.22
5 - Carbondale Southern IL AP / Marion	0.18	0.15	0.37	0.11	0.20

Note that correction factors do not add up to 1 (100%). This is attributed to periods of calm winds.

C_v = effectiveness of openings,

¹⁶⁹³ Average wind speeds are calculated based on the TMY3 wind speed data. Because this data is collected at an altitude of 33 ft, wind speed is approximated for a 5 ft level based on ASHRAE Handbook guidelines using the urban/suburban parameters for adjusting wind speed based on altitude (Layer thickness (ft) δ = 1200, Exponent a = 0.22). ASHRAE, "Airflow Around Buildings," in 2013 ASHRAE Handbook – Fundamentals (2013): p 24.3.

= 0.3, assumes diagonal wind¹⁶⁹⁴

L_a = Leakage Area (gap) between doorway and truck (ft²)
 = 16.8 feet¹⁶⁹⁵ or Actual.

The infiltration due to thermal forces is calculated as follows:

$$CFM_t = L_a * C_{dc} * (60 \text{ sec/min}) * \text{sqrt}[2 * g * H/2 * (T_{oc} - T_{ic}) / (459.7 + T_{oc})]$$

Where:

C_{dc} = the discharge coefficient during the cooling season¹⁶⁹⁶
 = $0.4 + 0.0025 * |T_{ic} - T_{oc}|$
 = 0.42, Illinois average at indoor air temp of 72°F

Note, values for C_{dc} show little variation due to balance point temperature, indoor air temperature, and climate zone. As such, if estimating results, the Illinois average value may be used as a simplification.

g = acceleration due to gravity
 = 32.2 ft/sec²

H = dock door height (ft)
 = user input

T_{ic} = Average indoor air temperature during cooling season
 = User input, can assume indoor cooling temperature set-point

T_{oc} = Average outdoor temp during cooling season (°F)
 = the average outdoor temperature is dependent on the CD period and zone. As such, the following table may be used for average outdoor temperature during the cooling period:¹⁶⁹⁷

Climate Zone Weather Station/City	T_{oc}				
	62 °F	67 °F	72 °F	77 °F	82 °F
1 - Rockford AP / Rockford	72.9	76.0	79.2	82.5	85.5
2 - Chicago O'Hare AP / Chicago	72.9	76.0	79.4	82.8	85.5
3 - Springfield #2 / Springfield	73.7	76.7	79.9	83.4	86.4
4 - Belleville SIU RSCH / Belleville	74.9	77.7	81.0	84.3	86.9
5 - Carbondale Southern IL AP / Marion	75.1	77.7	80.9	84.7	87.4

459.7 = conversion factor from °F to °R
 = calculation requires absolute temperature for values not calculated as a difference of temperatures.

¹⁶⁹⁴ ASHRAE, "Ventilation and Infiltration," in 2013 ASHRAE Handbook – Fundamentals (2013): p 16.13

¹⁶⁹⁵ Estimated 16.8 square feet of gap area. The leakage area is comprised of gaps on top, bottom and on the sides of the dock door. Common dock door dimensions are 8'0" in width with 8 ft, 9 ft or 10 ft heights. The maximum trailer size limits are 8'6" wide x 13'6" high (varies by state). Most trucks require a dock height of between 46 and 52 in. For the purposes of this calculation a 48" dock height and 9'0" wide x 10'0" high door was used, to cover the full range of truck types.

¹⁶⁹⁶ ASHRAE, "Ventilation and Infiltration," in 2013 ASHRAE Handbook – Fundamentals (2013): p 16.13.

¹⁶⁹⁷ Based on binned data from TMY3 & adjusted bracketed thermostat setpoint temperatures. Interpolate other values as needed.

SUMMER COINCIDENT PEAK DEMAND SAVINGS

$$\Delta kW = (\Delta kWh_{cooling} / (CD * 24)) * CF$$

Where:

- CF_{SSP} = Summer System Peak Coincidence Factor for Commercial cooling (during system peak hour)
= 91.3%¹⁶⁹⁸
- CF_{PJM} = PJM Summer Peak Coincidence Factor for Commercial cooling (average during peak period)
= 47.8%¹⁶⁹⁹

FOSSIL FUEL SAVINGS

Natural Gas savings associated with reduced infiltration through the gaps between the truck and the dock door during the heating season are calculated with the following formula:

$$\Delta \text{therms} = Q_{bs} * t_{open} * HD / \eta$$

Where:

- Q_{bs} = rate of sensible heat transfer through the gaps before dock door seal or shelter (therm/hr)
- t_{open} = average hours per day the door is open (hr/day)
= 8.25¹⁷⁰⁰ hours or actual.
- HD = heating days per year, as defined above
- η = efficiency of heating equipment
= Actual. If unknown, assume 0.8

Heat Transfer Through Dock Door without Dock Door Seals or Shelters (Heating Season)

$$Q_{bs} = (1.08 \text{ Btu}/(\text{hr} * \text{F} * \text{cfm})) * CFM_{tot} * (T_{ih} - T_{oh}) / (100,000 \text{ Btu}/\text{therm})$$

Where:

- 1.08 = sensible heat transfer coefficient (specific heat of air and unit conversions)
- CFM_{tot} = Total air flow through gaps (cfm)
- T_{ih} = Average indoor air temperature during heating season
= User input, can assume indoor heating temperature set-point
- T_{oh} = Average outdoor temp during heating season (°F)
= use table below, based on binned data from TMY3 & balance point temperature:

Climate Zone -Weather Station/City	Avg Outdoor Air Temp - Heating Season				
	45°F	50°F	55°F	60°F	65°F
1 - Rockford AP / Rockford	26.3	28.8	31.6	34.2	37.3
2 - Chicago O'Hare AP / Chicago	29.4	31.2	34.0	36.8	40.3
3 - Springfield #2 / Springfield	29.4	31.5	34.6	37.7	41.6

¹⁶⁹⁸ Based on analysis of Itron eShape data for Missouri, calibrated to Illinois loads, supplied by Ameren. The AC load during the utility’s peak hour is divided by the maximum AC load during the year.

¹⁶⁹⁹ Based on analysis of Itron eShape data for Missouri, calibrated to Illinois loads, supplied by Ameren. The average AC load over the PJM peak period (1-5pm, M-F, June through August) is divided by the maximum AC load during the year

¹⁷⁰⁰ Average loading time estimated at 45 minutes including truck arrival and departure time from: <https://www.novalocks.com/wp-content/uploads/Dock-Planning-Standards-Guide.pdf>. Average time between truck departure and arrival estimated at 90 minutes taken from customer interviews.

Climate Zone -Weather Station/City	Avg Outdoor Air Temp - Heating Season				
	45°F	50°F	55°F	60°F	65°F
4 - Belleville SIU RSCH / Belleville	31.7	33.6	36.2	39.2	42.3
5 - Carbondale Southern IL AP / Marion	32.5	34.9	37.8	40.7	44.0

The total airflow through the gaps, CFM_{tot}, includes both infiltration due to wind as well as thermal forces, as follows:

$$CFM_{tot} = \text{sqrt}[(CFM_w)^2 + (CFM_t)^2]$$

Where:

CFM_w = Infiltration due to the wind (cfm)

CFM_t = Infiltration due to thermal forces (cfm)

The infiltration due to the wind is calculated as follows:

$$CFM_w = (v_{wh} * C_{wh}) * C_v * L_a * (88 \text{ fpm/mph})$$

Where:

v_{wh} = average wind speed during the heating season (mph)

= similar to cooling season wind speed assumptions, use the following table to determine average wind speed based on entryway orientation:

Climate Zone -Weather Station/ City	Entryway Orientation				
	N	E	S	W	Average (unknown)
1 - Rockford AP / Rockford	5.0	4.6	4.9	5.6	5.0
2 - Chicago O'Hare AP / Chicago	5.5	5.2	4.9	5.1	5.2
3 - Springfield #2 / Springfield	5.0	4.9	5.3	5.1	5.1
4 - Belleville SIU RSCH / Belleville	4.3	3.4	3.5	5.3	4.1
5 - Carbondale Southern IL AP / Marion	4.6	3.2	4.2	4.4	4.1

C_{wh} = wind speed correction factor due to wind direction in heating season, (%)

= because wind direction is not constant, a wind speed correction factor is used to adjust for the amount of time during the heating season prevailing winds can be expected to impact the entryway. Use the following table to determine the correct wind speed correction factor for the heating applications.

Climate Zone -Weather Station/ City	Entryway Orientation				
	N	E	S	W	Average (unknown)
1 - Rockford AP / Rockford	0.18	0.13	0.30	0.31	0.23
2 - Chicago O'Hare AP / Chicago	0.21	0.10	0.26	0.39	0.24
3 - Springfield #2 / Springfield	0.21	0.14	0.27	0.34	0.24
4 - Belleville SIU RSCH / Belleville	0.31	0.15	0.22	0.29	0.24
5 - Carbondale Southern IL AP / Marion	0.31	0.11	0.27	0.18	0.22

Note that correction factors do not add up to 1 (100%). This is attributed to periods of calm winds.

C_v = effectiveness of openings,

= 0.3, assumes diagonal wind¹⁷⁰¹

L_a = Leakage Area (gap) between doorway and truck (ft²)
 = 16.8 feet¹⁷⁰² or Actual.

The infiltration due to thermal forces is calculated as follows:

$$CFM_t = L_a * C_{dh} * (60 \text{ sec/min}) * \text{sqrt}[2 * g * H/2 * (T_{ih} - T_{oh}) / (459.7 + T_{ih})]$$

Where:

C_{dh} = the discharge coefficient during the heating season
 = $0.4 + 0.0025 * |T_{ih} - T_{oh}|$
 = 0.49, Illinois average at indoor air temp of 72°F

Note, values for C_{dh} show little variation due to balance point temperature, indoor air temperature, and climate zone. As such, if estimating results, the Illinois average value may be used as a simplification.

g = acceleration due to gravity
 = 32.2 ft/sec²

H = dock door height (ft)
 = user defined

WATER AND OTHER NON-ENERGY IMPACT DESCRIPTIONS AND CALCULATION

N/A

DEEMED O&M COST ADJUSTMENT CALCULATION

N/A

MEASURE CODE: CI-SHL-DDSS-V01-230101

REVIEW DEADLINE: 1/1/2026

¹⁷⁰¹ ASHRAE, "Ventilation and Infiltration," in 2013 ASHRAE Handbook – Fundamentals (2013): p 16.13

¹⁷⁰² Estimated 16.8 square feet of gap area. The leakage area is comprised of gaps on top, bottom and on the sides of the dock door. Common dock door dimensions are 8'0" in width with 8 ft, 9 ft or 10 ft heights. The maximum trailer size limits are 8'6" wide x 13'6" high (varies by state). Most trucks require a dock height of between 46 and 52 in. For the purposes of this calculation a 48" dock height and 9'0" wide x 10'0" high door was use, to cover the full range of truck types.

4.8.7 Commercial Wall Insulation

DESCRIPTION

Wall insulation is added to building wall cavities or to building internal/external wall surfaces; foundation insulation is added to building internal/external foundation surfaces, both above grade and below grade. This measure requires pre- and post-implementation R-values and measurements surface areas.

This measure was developed to be applicable to the following program types: RF.

If applied to other program types, the measure savings should be verified.

DEFINITION OF EFFICIENT EQUIPMENT

The efficient scenario is the installation of added insulation. This measure requires a member of the implementation staff or a participating contractor to evaluate the pre- and post-implementation R-values and to measure surface areas. The requirements for participation in the program will be defined by the utilities.

DEFINITION OF BASELINE EQUIPMENT

The existing condition will be evaluated by implementation staff or a participating contractor and is likely to be empty or minimally insulated wall cavities, and uninsulated above and below grade foundation walls.

DEEMED LIFETIME OF EFFICIENT EQUIPMENT

The expected measure life is assumed to be 25 years.¹⁷⁰³

DEEMED MEASURE COST

Costs can be highly variable due to differences in building type and structural assemblies and therefore actual costs should be used when possible. Absent of actual cost information, estimated costs can be used. Per the W017 Itron California Measure Cost Study,¹⁷⁰⁴ the material cost for different assemblies and R-values can be assumed as follows:

Dimensions	R-value	Equipment Cost per sq.ft.	Labor Cost per sq.ft.	Incremental Cost per sq.ft.
2x4	R-15	\$0.34	\$0.81	\$1.15
2x6	R-19	\$0.41	\$0.81	\$1.22
2x6	R-21	\$0.44	\$0.81	\$1.25

LOADSHAPE

Loadshape C01 – Commercial Electric Cooling

Loadshape C03 – Commercial Cooling

Loadshape C04 – Commercial Electric Heating

Loadshape C05 – Commercial Electric Heating and Cooling

COINCIDENCE FACTOR

The summer peak coincidence factor for cooling is provided in two different ways below. The first is used to estimate peak savings during the utility peak hour and is most indicative of actual peak benefits, and the second represents the *average* savings over the defined summer peak period, and is presented so that savings can be bid into PJM's

¹⁷⁰³ Navigant 'ComEd Effective Useful Life Research Report', May 2018.

¹⁷⁰⁴ Measure costs are from the "2010-2012 W0017 Ex Ante Measure Cost Study", Itron, California Public Utilities Commission, May 2014. The data is provided in a file named "MCS Results Matrix – Volume I".

capacity market. Both values provided are based on analysis of Itron eShape data for Missouri, calibrated to Illinois loads, supplied by Ameren.

$$\begin{aligned} CF_{SSP} &= \text{Summer System Peak Coincidence Factor for Commercial cooling (during system peak hour)} \\ &= 91.3\% \text{ }^{1705} \end{aligned}$$

$$\begin{aligned} CF_{PJM} &= \text{PJM Summer Peak Coincidence Factor for Commercial cooling (average during peak period)} \\ &= 47.8\% \text{ }^{1706} \end{aligned}$$

Algorithm

CALCULATION OF SAVINGS

ELECTRIC ENERGY SAVINGS

Where available, savings from wall and foundation insulation measures should be determined through a custom analysis. When that is not feasible for the program the following engineering algorithms can be used.

$$\Delta kWh = \Delta kWh_{cooling} + \Delta kWh_{heatingElectric} + \Delta kWh_{heatingGas}$$

Where:

$$\begin{aligned} \Delta kWh_{cooling} &= \text{If building is cooled, reduction in annual cooling requirement due to wall insulation} \\ &= [(1 / R_{ExistWall} - 1 / R_{NewWall}) * A_{wall} + (1 / R_{ExistAG} - 1 / R_{NewAG}) * A_{AG} + (1 / R_{ExistBG} - 1 / R_{NewBG}) * A_{BG}] * EFLH_{cooling} * \Delta T_{FL,cooling} / 1000 / \eta_{Cool} * \%Cool \end{aligned}$$

Where:

$$\begin{aligned} R_{NewWall} &= \text{R-value of proposed new wall assembly (including all layers between inside air and outside air).} \\ &= \text{Actual} \end{aligned}$$

$$\begin{aligned} R_{ExistWall} &= \text{R-value value of existing assembly and any existing insulation.} \\ &= \text{Minimum of R-5 for uninsulated assemblies}^{1707} \end{aligned}$$

$$\begin{aligned} A_{wall} &= \text{Net area of insulated wall (ft}^2\text{)} \\ &= \text{Actual} \end{aligned}$$

$$\begin{aligned} R_{NewAG} &= \text{Effective R-value of proposed new Above-Ground Foundation assembly (including all layers between inside air and outside air).} \\ &= \text{Actual} \end{aligned}$$

$$\begin{aligned} R_{ExistAG} &= \text{Effective R-value value of existing Above-Ground Foundation assembly and any existing insulation.} \\ &= \text{Minimum of R-5 for uninsulated assemblies}^{1708} \end{aligned}$$

$$A_{AG} = \text{Net area of Above-Ground Foundation being insulated (ft}^2\text{)}$$

¹⁷⁰⁵ Based on analysis of Itron eShape data for Missouri, calibrated to Illinois loads, supplied by Ameren. The AC load during the utility's peak hour is divided by the maximum AC load during the year.

¹⁷⁰⁶ Based on analysis of Itron eShape data for Missouri, calibrated to Illinois loads, supplied by Ameren. The average AC load over the PJM peak period (1-5pm, M-F, June through August) is divided by the maximum AC load during the year.

¹⁷⁰⁷ An estimate based on review of Madison Gas and Electric, Exterior Wall Insulation, R-value for no insulation in walls, and NREL's Building Energy Simulation Test for Existing Homes (BESTEST-EX).

¹⁷⁰⁸ An estimate based on review of Madison Gas and Electric, Exterior Wall Insulation, R-value for no insulation in walls, and NREL's Building Energy Simulation Test for Existing Homes (BESTEST-EX).

- = Actual
- R_NewBG = Effective R-value of proposed new Foundation Below Grade assembly (including all layers between inside air and outside ground).
- = Actual
- R_ExistBG = Effective R-value value of existing Foundation Below Grade assembly and any existing insulation.

NOTE: Added to the above R-values of Below Grade assemblies shall be the following deemed Average Earth R-values, which account for transmission of heat through direct contact with the earth outside the foundation. The Effective Ground Contact R-value varies as a function of the average depth below grade of the bottom of the foundation:¹⁷⁰⁹

Depth Below Grade of Bottom of Foundation	Earth R-value	Average Earth R-value
0 feet	2.44 F-Ft ² -Hr/Btu	2.44 F-Ft ² -Hr/Btu
1 feet	4.50 F-Ft ² -Hr/Btu	3.47 F-Ft ² -Hr/Btu
2 feet	6.30 F-Ft ² -Hr/Btu	4.41 F-Ft ² -Hr/Btu
3 feet	8.40 F-Ft ² -Hr/Btu	5.41 F-Ft ² -Hr/Btu
4 feet	10.44 F-Ft ² -Hr/Btu	6.42 F-Ft ² -Hr/Btu
5 feet	12.66 F-Ft ² -Hr/Btu	7.46 F-Ft ² -Hr/Btu
6 feet	14.49 F-Ft ² -Hr/Btu	8.46 F-Ft ² -Hr/Btu
7 feet	17.00 F-Ft ² -Hr/Btu	9.53 F-Ft ² -Hr/Btu
8 feet	20.00 F-Ft ² -Hr/Btu	10.69 F-Ft ² -Hr/Btu

- A_BG = Net area of Foundation Below Grade being insulated (ft²)
- = Actual
- EFLH_{cooling} = Equivalent Full Load Hours for Cooling [hr] in Existing Buildings or New Construction are provided in Section 4.4, HVAC end use
- $\Delta T_{FL,cooling}$ = Temperature difference [°F] during cooling season between design day outdoor air temperature (T_{DD}) and assumed 55°F base temperature

Climate Zone (City based upon)	T _{DD,cooling} [°F] ¹⁷¹⁰	$\Delta T_{FL,cooling}$ [°F]
1 (Rockford)	90.9	35.9
2 (Chicago)	91.3	36.3
3 (Springfield)	92.6	37.6
4 (Belleville)	95.2	40.2
5 (Marion)	94.4	39.4

- 1000 = Converts Btu to kBtu

¹⁷⁰⁹ Source: Illinois Statewide Technical Reference Manual V10.0, Volume 3 - Section 5.6.2 Basement Sidewall Insulation, Table on page 338 of 401.

¹⁷¹⁰ Weather Station Data, 0.4% Cooling DB - 2021 ASHRAE Handbook, Fundamentals. The following weather stations were referenced: Climate Zone 1: Chicago Rockford Int'l, Climate Zone 2: Chicago O'Hare Int'l, Climate Zone 3: Abraham Lincoln Capital, Climate Zone 4: Scott AFB, Climate Zone 5: Cape Girardeau Regional.

η_{Cool} = Efficiency of cooling system. Actual, if known. Alternatively, use IECC 2012 as a default source if equipment type is known, or as deemed from table below¹⁷¹¹

Space Cooling / Heating Source	Deemed Cooling EER	Deemed Cooling SEER
No Cooling	N/A	N/A
Unknown Cooling Source	11	13

$\%Cool$ = Percent of building **where wall or foundation insulation is to be installed** that is cooled
 = Actual %, if known, or, If actual % unknown, use following deemed values:

Is Space Being Insulated Cooled?	Deemed %Cool, if actual % is unknown
Yes	100%
No	0%

For example, for a elementary school building with unknown cooling equipment in Rockford with increase in wall insulation: $R_{ExistWall} = 5.0$; $R_{NewWall} = 16.0$; $A_{wall} = 1,500$; $\eta_{Cool} = 13.0$; $\%Cool = 100\%$

$$\Delta kWh_{cooling} = (1/5.0 - 1/16.0) * 1,500 * 834 * 35.9 / 1,000 / 11.0 * 100\% = 561 \text{ kWh}$$

$\Delta kWh_{heatingElectric}$ = If electric heat (resistance or heat pump), reduction in annual electric heating due to wall and/or foundation insulation

$$= [(1/R_{ExistWall} - 1/R_{NewWall}) * A_{wall} + (1/R_{ExistAG} - 1/R_{NewAG}) * A_{AG} + (1/R_{ExistBG} - 1/R_{NewBG}) * A_{BG}] * EFLH_{heating} * \Delta T_{FL,heating} / \eta_{Heat} / 3412 * \%ElectricHeat$$

Where:

$EFLH_{heating}$ = Equivalent Full Load Hours for Heating [hr] in Existing Buildings or New Construction are provided in Section 4.4, HVAC end use

$\Delta T_{FL,heating}$ = Temperature difference [°F] during heating season between design day outdoor air temperature and assumed 55°F heating base temperature

Climate Zone (City based upon)	$T_{DD,heating}$ [°F] ¹⁷¹²	$\Delta T_{FL,heating}$ [°F]
1 (Rockford)	-5.4	60.4
2 (Chicago)	-1.0	56.0
3 (Springfield)	1.1	53.9
4 (Belleville)	7.2	47.8
5 (Marion)	10.1	44.9

¹⁷¹¹ Simplified version of IECC 2012 as a conservative estimate of what is existing

¹⁷¹² Weather Station Data, 96.6% Heating DB - 2021 ASHRAE Handbook, Fundamentals. The following weather stations were referenced: Climate Zone 1: Chicago Rockford Int'l, Climate Zone 2: Chicago O'Hare Int'l, Climate Zone 3: Abraham Lincoln Capital, Climate Zone 4: Scott AFB, Climate Zone 5: Cape Girardeau Regional.

η_{Heat} = Efficiency of heating system. Actual, or as deemed from table below

System Type	Cooling Capacity of Equipment	Age of Equipment	HSPF Estimate	η (Effective COP Estimate) (HSPF/3.413)
Heat Pump ¹⁷¹³	All	Before 2009	6.8	2.0
	< 65,000 Btu/h	2009 - 2017	7.7	2.3
		2017 on	8.2	2.40
	$\geq 65,000$ Btu/h and < 135,000 Btu/h	2010 on	11.3	3.3
	$\geq 135,000$ Btu/h and < 240,000 Btu/h	2010 on	10.9	3.2
$\geq 240,000$ Btu/h and < 760,000 Btu/h	2010 on	10.9	10.9	3.2
Resistance	N/A	N/A	N/A	1
Natural Gas Furnace or Boiler	N/A	N/A	N/A	0.8 E _T

3412 = Converts Btu to kWh

%ElectricHeat = Percent of building where wall or foundation insulation is to be installed that is electrically heated

= Actual %, if known, or, If actual % unknown, use following deemed values:

Is Space Being Insulated Electrically Heated?	Deemed %ElectricHeat, if actual % is unknown
Yes	100%
No	0%

For example, for a elementary school building with resistance heating in Rockford: R_ExistWall = 5.0; R_NewWall = 16.0; A_wall = 1,500; η_{Heat} = 1.0; %ElectricHeat = 100%

$$\Delta kWh_{heatingElec} = (1/5.0 - 1/16.0) * 1,500 * 1,614 * 60.4 / 3,412 / 1.0 * 100\%$$

$$= 5,893 \text{ kWh}$$

$\Delta kWh_{heatingGas}$ = If gas *furnace* heat, kWh savings for reduction in combustion fan run time
 = $\Delta Therms * F_e * 29.3$

Where:

$\Delta Therms$ = Annual therms of gas space heating saved, as determined below

¹⁷¹³ Minimum heating efficiency standards for heat pumps are sourced from the Code of Federal Standards for Small and Large Commercial Package Air Conditioning and Heating Equipment (Air Cooled), 10 CFR 431.97 with compliance dates of June 16, 2008; January 1, 2010; January 1, 2017; and January 1, 2018. As the first federal appliance standards for heating efficiency for commercial heat pumps went into effect in June 2008, assuming efficiency standards equivalent to residential heat pumps prior to that date.

F_e = Furnace or boiler combustion fan energy consumption as a percentage of annual fuel consumption
 = 7.7%¹⁷¹⁴

29.3 = conversion of therms to kWh (= 100,000 / 3412)

For example, if: Δ Therms = 251; F_e = 7.7%, then:

$$\Delta kWh_{\text{heatingGas}} = 251 * 7.7\% * 29.3$$

$$= 566 \text{ kWh}$$

SUMMER COINCIDENT PEAK DEMAND SAVINGS

$$\Delta kW = \Delta kWh_{\text{cooling}} / EFLH_{\text{Cooling}} * CF$$

Where:

$\Delta kWh_{\text{cooling}}$ = Annual kWh saving in cooling energy use, as determined above

$EFLH_{\text{cooling}}$ = Equivalent Full Load Hours for cooling in Existing Buildings are provided in section 4.4 HVAC End Use

CF_{SSP} = Summer System Peak Coincidence Factor for Commercial cooling (during system peak hour)
 = 91.3%¹⁷¹⁵

CF_{PJM} = PJM Summer Peak Coincidence Factor for Commercial cooling (average during peak period)
 = 47.8%¹⁷¹⁶

For example, for a elementary school in Rockford with unknown cooling per above example: $\Delta kWh_{\text{cooling}}$ = 687; $EFLH_{\text{Cooling}}$ = 1,020; CF = 0.478; then:

$$\Delta kW = 687 / 1020 * 0.478$$

$$= 0.32 \text{ kW}$$

FOSSIL FUEL SAVINGS

If Natural Gas heating:

$$\Delta \text{Therms} = [(1/R_{\text{ExistWall}} - 1/R_{\text{NewWall}}) * A_{\text{wall}} + (1/R_{\text{ExistAG}} - 1/R_{\text{NewAG}}) * A_{\text{AG}} + (1/R_{\text{ExistBG}} - 1/R_{\text{NewBG}}) * A_{\text{BG}}] * EFLH_{\text{heating}} * \Delta T_{FL, \text{heating}} / \eta_{\text{Heat}} / 100,000 * \% \text{GasHeat}$$

Where:

$\% \text{GasHeat}$ = Percent of space being retrofitted with insulation that is heated using gas

¹⁷¹⁴ F_e is not one of the AHRI certified ratings provided for residential furnaces, but can be reasonably estimated from a calculation based on the certified values for fuel energy (E_f in MMBtu/yr) and E_{ae} (kWh/yr). An average of a 300 record sample (non-random) out of 1495 was 3.14%. This is, appropriately, ~50% greater than the ENERGY STAR version 3 criteria for 2% F_e . See “Programmable Thermostats Furnace Fan Analysis.xlsx” for reference.

¹⁷¹⁵ Based on analysis of Itron eShape data for Missouri, calibrated to Illinois loads, supplied by Ameren. The AC load during the utility’s peak hour is divided by the maximum AC load during the year.

¹⁷¹⁶ Based on analysis of Itron eShape data for Missouri, calibrated to Illinois loads, supplied by Ameren. The average AC load over the PJM peak period (1-5pm, M-F, June through August) is divided by the maximum AC load during the year.

= Actual %, if known, or, If actual % unknown, use following deemed values:

Is Space Being Insulated Heated with Gas?	Deemed %GasHeat, if actual % is unknown
Yes	100%
No	0%

Other variables as defined above.

For example, for a elementary school building in Rockford with unknown gas heat: R_ExistWall = 5.0; R_NewWall = 16.0; A_wall = 1,500; ηHeat = 0.8; %GasHeat = 100%; then

$$\begin{aligned} \Delta\text{Therms} &= (1/5.0 - 1/16.0) * 1500 * 1,614 * 60.4 / 0.8 / 100,000 * 100\% \\ &= 251 \text{ therms} \end{aligned}$$

WATER IMPACT DESCRIPTIONS AND CALCULATION

N/A

DEEMED O&M COST ADJUSTMENT CALCULATION

N/A

MEASURE CODE: CI-SHL-WINS-V04-250101

REVIEW DEADLINE: 1/1/2026

4.8.8 Commercial Secondary Windows

DESCRIPTION

Commercial Secondary Windows (CSW) are window units with one or more transparent panes in a frame that attach to the interior or exterior of existing windows without replacing the original glass or frame. Secondary windows are retrofitted to existing commercial windows to improve their overall thermal performance by adding a layer of glazing. CSWs have a non-disruptive installation and can improve windows to meet current IECC¹⁷¹⁷ standards, resulting in heating and cooling energy savings.

Single-pane clear windows can increase the energy load through increased heat gain or heat loss, ultimately disrupting occupant comfort, and raising energy costs. Replacing windows can be costly, time-consuming, and disruptive to occupants, and hence it presents an opportunity of secondary window retrofits as a cost-effective energy efficiency measure.

A prescriptive methodology was developed to calculate energy savings associated with CSW retrofits in different commercial buildings across all Illinois climate zones through an energy modeling¹⁷¹⁸ analysis. An AERC¹⁷¹⁹ single-pane, metal-framed window was used as the baseline during the analysis and compared to a CSW retrofit meeting IECC 2021 standards for exterior fenestration assemblies. Heating and Cooling energy savings factors are derived from the energy modeling analysis for different building types and climate zones in Illinois and are utilized in the methodology section to calculate measure energy savings.

An external spreadsheet calculator¹⁷²⁰ has been developed to calculate energy savings associate with this measure based on building-specific inputs listed below.

- Building Types
- Hospital, Hotel, Multifamily, Office, Restaurant, Retail/Strip Mall and School
- Total Area of CSW Retrofit
- Heating System Fuel
- Gas or Electric
- Gas Heating System Efficiency
- Electric Heating System Efficiency
- Cooling System Efficiency
- Building Location Zip Code
 - Zip codes for the state of Illinois matching one of the following climate zones:
 - 1 – Rockford
 - 2– Chicago
 - 3– Springfield
 - 4– Belleville
 - 5 – Marion

The calculator incorporates heating and cooling energy savings factors for different building types and locations based on the energy modeling analysis performed on the DOE's Prototype Building Models¹⁷²¹.

¹⁷¹⁷ IECC 2021 – <https://codes.iccsafe.org/content/IECC2021P2> based on current state code defined under <https://www.energycodes.gov/status/states/illinois>

¹⁷¹⁸ Energy Modeling was Performed in EnergyPlus (E+), using the DOE's Office of Energy Efficiency & Renewable Energy (EERE) Prototype Building Models with different Illinois climate zones. Detailed information on energy modeling methodology, inputs and assumptions along with references are detailed in the calculator tool, see Energy Savings Calculator for CSW 05-15.xlsm

¹⁷¹⁹ AERC 1 – [Attachments Energy Rating Council](#)

¹⁷²⁰ See Energy Savings Calculator for CSW 05-15.xlsm

¹⁷²¹ [DOE EERE Prototype Buildings](#)

DEFINITION OF EFFICIENT EQUIPMENT

Efficient equipment in this measure refers to commercial secondary windows (CSW) retrofitted in buildings. Retrofitted CSW assembly shall have minimum thermal properties as indicated in table below.

	Center of Glass U-Factor of the Overall window assembly with CSW Retrofit (Btu/hr °F ft2)	Solar Heat Gain Coefficient of the Overall window assembly with CSW Retrofit
Efficient CSW Unit ¹⁷²²	0.36	0.58

DEFINITION OF BASELINE EQUIPMENT

Baseline equipment refers to existing non-operable clear single-pane windows in existing buildings.

DEEMED LIFETIME OF EFFICIENT EQUIPMENT

The measure life is assumed to be 30 years¹⁷²³.

DEEMED MEASURE COST

Total installation cost for retrofitting the Commercial Secondary Windows is the deemed measure cost. Total measure cost is assumed to be 32\$ per square feet¹⁷²⁴ of CSW systems installed.

LOADSHAPE

Loadshape C03- Commercial Cooling

Loadshape C04 - Commercial Electric Heating

Loadshape C05 - Commercial Electric Heating and Cooling

COINCIDENCE FACTOR

CFSSP = Summer System Peak Coincidence Factor for Commercial cooling (during system peak hour)
 = 91.3%¹⁷²⁵

CFPJM = PJM Summer Peak Coincidence Factor for Commercial cooling (average during peak period)
 = 47.8%¹⁷²⁶

¹⁷²² Minimum thermal properties for the efficient Commercial Secondary Window unit are based on the 2021 International Energy Efficiency Code- maximum allowable U-factors and Solar Heat Gain Coefficients (SHGC) for fixed windows.

https://codes.iccsafe.org/content/IECC2021P2/chapter-4-ce-commercial-energy-efficiency#IECC2021P2_CE_Ch04_SecC402

¹⁷²³ Effective useful life based on commercial secondary glazing systems measure in regional technical forum, technical advisory committee to Northwest Power and Conservation Council.

[Commercial Secondary Glazing Systems \(nwcouncil.org\)](https://www.nwcouncil.org/commercial-secondary-glazing-systems)

¹⁷²⁴ Average total installed cost for CSW systems from “Secondary Glazing Systems: Market and Deployment Development” by Slipstream prepared for the Nicor Gas Energy Efficiency Program.

¹⁷²⁵ Based on analysis of Itron eShape data for Missouri, calibrated to Illinois loads, supplied by Ameren. The AC load during the utility’s peak hour is divided by the maximum AC load during the year.

¹⁷²⁶ Based on analysis of Itron eShape data for Missouri, calibrated to Illinois loads, supplied by Ameren. The average AC load over the PJM peak period (1-5pm, M-F, June through August) is divided by the maximum AC load during the year.

Algorithm

CALCULATION OF ENERGY SAVINGS

ELECTRIC ENERGY SAVINGS

$$\Delta kWh = (\Delta kWh_{cooling} + \Delta kWh_{heatingElectric} + \Delta kWh_{heatingGas})$$

$$\Delta kWh_{cooling} = CSF * A * 3412.14 / (\eta_{Cool} * 1000)$$

Where:

$$CSF^{1727} = \text{Cooling energy savings factor, kWh/ft}^2/\text{Btu/Wh}$$

Building Types ¹⁷²⁸	Cooling Energy Savings Factor for Different Climate Zones and Building Types (kWh/ft ² /BTU/Wh)				
	1-Rockford	2-Chicago	3-Springfield	4-Belleville	5-Marion
Hospital	19.48	19.41	21.42	21.37	21.24
Hotel	16.07	16.21	18.61	18.09	18.61
Multifamily	14.46	14.54	16.96	16.54	17.32
Office	16.24	15.87	17.91	17.06	17.91
Restaurant	13.54	13.63	16.19	15.63	16.55
Retail/Strip Mall	16.54	16.80	18.92	17.98	18.82
School	16.51	16.12	18.31	17.09	17.79

A = Area of CSW system installed, ft²

η_{Cool} = Seasonal Energy Efficiency Ratio of cooling system (kBtu/kWh)

= Actual value (where new or where it is possible to measure or reasonably estimate) or refer to IECC 2012¹⁷²⁹ minimum efficiency ratings based on the type of cooling equipment or refer to the table below if equipment type is unknown.

Equipment Type	η_{Cool} Estimate ¹⁷³⁰
Unknown cooling equipment	13

$$\Delta kWh_{heatingElectric} = HSF * A * 8.58 / \eta_{Heat}$$

Where:

¹⁷²⁷ Cooling energy savings factor based on energy modeling on U.S. Department of Energy – Commercial prototype building models comparing window performance with CSW Retrofits and baseline single pane windows. Energy model inputs, results and assumptions will be externally attached for the Illinois Stakeholder Advisory Group – Technical Advisory Committee (TAC).

¹⁷²⁸ Building type classification should be based on definitions under Illinois Technical Reference Manual version 12, volume 1: overview and user guide, section 3.6. [IL-TRM Effective 010124 v12.0 Vol 1 Overview 09222023 FINAL clean.pdf \(ilsag.info\)](#).

For building types unknown, building type should be selected to closely resemble one of the building types listed in the table per interpretation of the program implementor based on actual building usage.

¹⁷²⁹ International Energy Efficiency Code 2012, chapter 4 Commercial Energy Efficiency, table c403.2.3(1) minimum efficiency requirements: electrically operated unitary air conditioners and condensing units.

<https://codes.iccsafe.org/content/IECC2012/chapter-4-ce-commercial-energy-efficiency>

¹⁷³⁰ IECC 2012 conservative minimum SEER rating of 13.0 is assumed for cooling system efficiency if the system type is unknown.

- HSF¹⁷³¹ = Heating energy savings factor, Therms/ft²/Btu/Wh
 = Refer to Fossil Fuel Savings section
- 8.58 = Factor to account for Therms to Wh and for Btu to kWh unit conversions
- ηHeat = Efficiency of heating system
 = Actual value (where new or where it is possible to measure or reasonably estimate) or refer to CFR 431 minimum efficiency ratings based on the type of heating equipment or refer to the table below if equipment type is unknown.

System Type	Age of Equipment	HSPF Estimate ¹⁷³²	ηHeat (Effective COP Estimate) (HSPF/3.413)
Resistance	N/A	N/A	1
Unknown	N/A	10.92	3.2

- ΔkWh_heatingGas = If gas furnace heat, kWh savings for reduction in fan run time
 = ΔTherms * Fe * 29.3

Where:

- Fe = Furnace Fan energy consumption as a percentage of annual fuel consumption
 = 7.7%¹⁷³³
- 29.3 = kWh per therm

For Example, a hotel in Rockford with an all electric HVAC system installing 50 sqft of commercial secondary windows would save:

$$\Delta kWh = \Delta kWh \text{ Cooling} + \Delta kWh \text{ HeatingElectric} + \Delta kWh \text{ HeatingGas}$$

$$\begin{aligned} \Delta kWh \text{ Cooling} &= CSF * A * 3,412.14 / (\eta_{Cool} * 1,000) \\ &= 16.07 * 50 * 3412.14 / (13 * 1000) \\ &= 210.9 \text{ kWh} \end{aligned}$$

$$\begin{aligned} \Delta kWh \text{ Heating Electric} &= HSF * A * 8.58 / \eta_{Heat} \\ &= 0.94 * 50 * 8.58 / 3.2 \\ &= 126.1 \text{ kWh} \end{aligned}$$

$$\begin{aligned} \Delta kWh &= 210.9 + 126.1 + 0 \\ &= 337.0 \text{ kWh} \end{aligned}$$

¹⁷³¹ Heating energy savings factor based on energy modeling on U.S. Department of Energy – Commercial prototype building models comparing window performance with CSW Retrofits and baseline single pane windows. Energy model inputs, results and assumptions will be externally attached for the Illinois Stakeholder Advisory Group – Technical Advisory Committee (TAC).

¹⁷³² U.S. Department of energy, federal code for standards, Title 10, chapter II, subchapter D, part 431.97(b). [eCFR :: 10 CFR Part 431 -- Energy Efficiency Program for Certain Commercial and Industrial Equipment](#)

¹⁷³³ Fe is estimated using TRM models for the three most popular building types for programmable thermostats: low-rise office (10.2%), sit-down restaurant (8.6%), and retail–strip mall (4.4%). 7.7% reflects the average Fe of the three building types. See “Fan Energy Factor Example Calculation 2021-06-23.xlsx” for reference.

SUMMER COINCIDENT PEAK DEMAND SAVINGS

$$\Delta kW = (\Delta kWh_{cooling} / EFLH_{cooling}) * CF$$

Where:

EFLH_{cooling} = Equivalent full load hours of air conditioning in Existing Buildings or New Construction are provided in Section 4.4, HVAC end use

CF_{SSP} = Summer System Peak Coincidence Factor for Commercial cooling (during system peak hour)
= 91.3%¹⁷³⁴

CF_{PJM} = PJM Summer Peak Coincidence Factor for Commercial cooling (average during peak period)
= 47.8%¹⁷³⁵

FOSSIL FUEL SAVINGS

$$\Delta Therms = HSF * A * \eta_{Heat}$$

Where:

HSF¹⁷³⁶ = Heating energy savings factor, Therms/ft²

Building Types ¹⁷³⁷	Heating Energy Savings Factor for Different Climate Zones and Building Types (Therms/ft ²)				
	1-Rockford	2-Chicago	3-Springfield	4-Belleville	5-Marion
Hospital	0.83	0.80	0.64	0.62	0.61
Hotel	0.94	0.89	0.77	0.71	0.69
Multifamily	1.03	0.99	0.88	0.79	0.76
Office	0.82	0.80	0.72	0.65	0.63
Restaurant	0.96	0.90	0.81	0.76	0.73
Retail/Strip Mall	0.90	0.84	0.76	0.72	0.69
School	0.85	0.83	0.75	0.69	0.66

η_{Heat} = Efficiency of heating system in Et or Ec where Et is the thermal efficiency and Ec is the combustion efficiency as defined in 10 CFR 431.

= Actual or if known use values from table below

¹⁷³⁴ Based on analysis of Itron eShape data for Missouri, calibrated to Illinois loads, supplied by Ameren. The AC load during the utility’s peak hour is divided by the maximum AC load during the year.

¹⁷³⁵ Based on analysis of Itron eShape data for Missouri, calibrated to Illinois loads, supplied by Ameren. The average AC load over the PJM peak period (1-5pm, M-F, June through August) is divided by the maximum AC load during the year.

¹⁷³⁶ Heating energy savings factor based on energy modeling on U.S. Department of Energy – Commercial prototype building models comparing window performance with CSW Retrofits and baseline single pane windows. Energy model inputs, results and assumptions will be externally attached for the Illinois Stakeholder Advisory Group – Technical Advisory Committee (TAC).

¹⁷³⁷ Building type classification should be based on definitions under Illinois Technical Reference Manual version 12, volume 1: overview and user guide, section 3.6. [IL-TRM Effective_010124_v12.0_Vol_1_Overview_09222023_FINAL_clean.pdf \(ilsag.info\)](#).

For building types unknown, building type should be selected to closely resemble one of the building types listed in the table based on the interpretation of the program implementor.

Equipment type	Certified rated input	η_{Heat} ^{1738 1739}
Gas Furnaces	$\geq 300,000$ Btu/h (from 01/01/1994 – 01/01/2023)	80% Et
	$\geq 300,000$ Btu/h (After 01/01/2023)	81% Et
Gas-fired hot water Boilers	$\geq 300,000$ Btu/h and $\leq 2,500,000$ Btu/h	80% Et
	$> 2,500,000$ Btu/h	82% Ec
Gas-fired steam Boilers	$\geq 300,000$ Btu/h (till 03/02/2022)	77% Et
	$\geq 300,000$ Btu/h (after 03/02/2022)	79% Et

For Example, a hotel in Rockford with a gas furnace installed before 2023 installing 50 sqft of Commercial Secondary Windows would save:

$$\Delta \text{kWh} = \Delta \text{kWh Cooling} + \Delta \text{kWh Heating Electric} + \Delta \text{kWh Heating Gas}$$

$$\Delta \text{kWh Heating Gas} = \Delta \text{Therms} * \text{Fe} * 29.3$$

$$\Delta \text{Therms} = \text{HSF} * \text{A} * \eta_{\text{Heat}}$$

$$= 0.94 * 50 * 80\%$$

$$= 37.6 \text{ Therms}$$

$$\Delta \text{kWh Heating Gas} = 37.6 * 7.7\% * 29.3$$

$$= 84.8 \text{ kWh}$$

$$\Delta \text{kWh} = 210.9 + 0 + 84.8$$

$$= 295.7 \text{ kWh}$$

WATER AND OTHER NON-ENERGY IMPACT DESCRIPTIONS AND CALCULATION

N/A

DEEMED O&M COST ADJUSTMENT CALCULATION

N/A

MEASURE CODE: CI-SHL-CSW-V01-250101

REVIEW DEADLINE: 1/1/2029

¹⁷³⁸ Code of federal regulations, title 10, chapter ii, subchapter D, part 431, subpart C Energy and water conservation standards. [eCFR :: 10 CFR Part 431 Subpart D -- Commercial Warm Air Furnaces](#)

¹⁷³⁹ Code of federal regulations, title 10, chapter ii, subchapter D, part 431, subpart E Energy Efficiency standards. [eCFR :: 10 CFR Part 431 Subpart E -- Commercial Boilers](#)

4.9. Miscellaneous End Use

4.9.1 Pump Optimization

DESCRIPTION

Pump improvements can be done to optimize the design and control of centrifugal water pumping systems, including water solutions with freeze protection up to 15% concentration by volume. Other fluid and gas pumps cannot use this measure calculation. The measurement of energy and demand savings for commercial and industrial applications will vary with the type of pumping technology, operating hours, efficiency, and existing and proposed controls. Depending on the specific application slowing the pump, trimming or replacing the impeller may be suitable options for improving pumping efficiency. Pumps up to 40 HP are allowed to use this energy savings calculation. Larger motors should use a custom calculation (which may result in larger savings than this measure would claim).

DEFINITION OF EFFICIENT EQUIPMENT

In order for this characterization to apply, the efficient equipment is proven to be an optimized centrifugal pumping system meeting the applicable program efficiency requirements:

Pump balancing valves no more than 15% throttled

Balancing valves on at least one load 100% open.

DEFINITION OF BASELINE EQUIPMENT

In order for this characterization to apply, the baseline equipment is assumed to be the existing pumping system including existing controls and sequence of operations.

DEEMED LIFETIME OF EFFICIENT EQUIPMENT

The expected measure life is assumed to be 8 years.¹⁷⁴⁰

DEEMED MEASURE COST

The incremental capital cost for this measure can vary considerably depending upon the strategy employed to achieve the required efficiency levels and should be determined on a site-specific basis.

LOADSHAPE

Loadshape C14: Indust. 1-shift (8/5) (e.g., comp. air, lights)

Loadshape C15: Indust. 2-shift (16/5) (e.g., comp. air, lights)

Loadshape C16: Indust. 3-shift (24/5) (e.g., comp. air, lights)

Loadshape C17: Indust. 4-shift (24/7) (e.g., comp. air, lights)

COINCIDENCE FACTOR

The summer peak coincidence factor for this measure is assumed to be 38%.¹⁷⁴¹

¹⁷⁴⁰ SCE Pump Test Final Report (2009), Summit Blue Consulting, LLC. This value is a weighted average of estimates provided by program participants.

¹⁷⁴¹ Summer Peak Coincidence Factor has been preserved from the "Technical Reference Manual" (TRM) for Ohio Senate Bill 221 Energy Efficiency and Conservation Program and 09-512-GE-UNC," October 15, 2009. This is likely a conservative estimate, but is recommended for further study (as stated in the OH State TRM, page 269).

Algorithm

CALCULATION OF SAVINGS

ELECTRIC ENERGY SAVINGS

$$\Delta kWh = (HP_{motor} * 0.746 * LF / \eta_{motor}) * HOURS * ESF$$

Where:

HP_{motor} = Installed nameplate motor horsepower
= Actual

0.746 = Conversion factor from horse-power to kW (kW/hp)

LF / η_{motor} = Combined as a single factor since efficiency is a function of load
= 0.65¹⁷⁴²

Where:

LF = Load Factor; Ratio of the peak running load to the nameplate rating of the motor

η_{motor} = Motor efficiency at pump operating conditions

HOURS = Annual operating hours of the pump
= Actual

ESF = Energy Savings Factor; assume a value of 15%.¹⁷⁴³

SUMMER COINCIDENT PEAK DEMAND SAVINGS

$$\Delta kW = (HP_{motor} * 0.746 * (LF / \eta_{motor})) * (ESF) * CF$$

Where:

CF = Summer Coincident Peak Factor for measure

FOSSIL FUEL SAVINGS

N/A

WATER IMPACT DESCRIPTIONS AND CALCULATION

N/A

DEEMED O&M COST ADJUSTMENT CALCULATION

N/A

MEASURE CODE: CI-MSC-PMPO-V04-220101

REVIEW DEADLINE: 1/1/2027

¹⁷⁴² "Measured Loading of Energy Efficient Motors - the Missing Link in Engineering Estimates of Savings," ACEEE 1994 Summer Study Conference, Asilomar, CA.

¹⁷⁴³ Published estimates of typical pumping efficiency improvements range from 5 to 40%. For analysis purposes, assume 15%. United States Industrial Electric Motor Systems Market Opportunities Assessment December 2002, Table E-7, Page 18.

4.9.2 Computer Power Management Software

DESCRIPTION

This measure characterizes the savings achieved through controlling the power management settings of a desktop computer, monitor or laptop. This can be achieved one of two ways; either a centralized computer power management software is installed on a network of computers to monitor and record usage and manage the power management settings of all units (referred to as Centralized Software), or the settings are adjusted on each individual unit (referred to as Individual Settings).

DEFINITION OF EFFICIENT EQUIPMENT

For Centralized Software, the efficient equipment is defined by the requirements listed below:

- Allow centralized control and override of computer power management settings of workstations which include both a computer monitor and CPU (i.e., a desktop or laptop computer on a distributed network)
- Be able to control on/off/sleep states on both the CPU and monitor according to the Network Administrator-defined schedules and apply power management policies to network groups
- Have capability to allow networked workstations to be remotely wakened from power-saving mode (e.g. for system maintenance or power/setting adjustments)
- Have capability to detect and monitor power management performance and generate energy savings reports
- Have capability to produce system reports to confirm the inventory and performance of equipment on which the software is installed.

For Individual Settings, each desktop, monitor, or laptop requires power settings to be adjusted to appropriately place devices in a low-power standby, sleep or off mode after a predetermined period of inactivity (for example display sleep mode after 10 minutes of inactivity and computer sleep mode after 30 minutes).

This measure was developed to be applicable to the following program types: RF. If applied to other program types, the measure savings should be verified.

DEFINITION OF BASELINE EQUIPMENT

Baseline is defined as a desktop computer, monitor or laptop without the power management settings enabled.

DEEMED LIFETIME OF EFFICIENT EQUIPMENT

For Centralized Software, the expected measure life is five years.¹⁷⁴⁴

For Individual Settings, the expected measure life is two years.¹⁷⁴⁵

DEEMED MEASURE COST

For Centralized Software, the deemed measure cost is \$29 per networked computer, including labor.¹⁷⁴⁶

For Individual Settings, the deemed measure cost is \$10 per unit.¹⁷⁴⁷

LOADSHAPE

Loadshape C21 – Commercial Office Equipment.

¹⁷⁴⁴ Computers and peripheral equipment are considered 5-year property. 2016 IRS Publication 946.

<https://www.irs.gov/pub/irs-prior/p946--2016.pdf>

¹⁷⁴⁵ Reduced estimate accounting for settings only lasting as long as units are in operation and the ease at which they can be turned off or adjusted in any one individual machine, due to personal preference.

¹⁷⁴⁶ Work Paper WPSCNROE0003 Revision 1, Power Management Software for Networked Computers. Southern California Edison.

¹⁷⁴⁷ Estimate assuming 15 minutes of labor at \$40/hour rate.

COINCIDENCE FACTOR

N/A

Algorithm

CALCULATION OF ENERGY SAVINGS

ELECTRIC ENERGY SAVINGS

$$\Delta kWh = ((UECCompBase - UECCompEff) + (UECMonBase - UECMonEff))$$

Where:

UECComBase = Energy consumption of computer before adjusting power settings
 $(\sum State PowerState \times HoursBase,State) / 1,000$

UECComEff = Energy consumption of computer after adjusting power settings
 $(\sum State PowerState \times HoursEff,State) / 1,000$

UECMonBase = Energy consumption of monitor before adjusting power settings
 $(\sum State MpW \times PowerState \times HoursBase,State) / 1,000$

UECMonEff = Energy consumption of monitor after adjusting power settings
 $(\sum State MpW \times PowerState \times HoursEff,State) / 1,000$

HoursBase,State = Annual hours in each power state¹⁷⁴⁸
 $8,760 \times BaseDutyCycle(\%)$

Computer Power State	Base Duty Cycle	
	Computer	Monitor
Unplugged	5%	22%
Off	55%	50%
Sleep	2%	2%
Idle	35%	N/A
Active	3%	26%

Hours Eff,State = Annual hours in each power state¹⁷⁴⁹
 $8,760 \times EfficientDutyCycle(\%)$

Computer Power State	Efficient Duty Cycle	
	Computer	Monitor
Unplugged	5%	22%

¹⁷⁴⁸ Northwest Regional Technical Forum Non-Res Network Computer Power Management , January 29, 2015. Analysis can be found in NonResNetCompPwrMgt_v4_1.xlsm. <https://rtf.nwcouncil.org/measure/non-res-network-computer-power-management>

¹⁷⁴⁹ Northwest Regional Technical Forum Non-Res Network Computer Power Management , January 29, 2015. Analysis can be found in NonResNetCompPwrMgt_v4_1.xlsm. <https://rtf.nwcouncil.org/measure/non-res-network-computer-power-management>

Computer Power State	Efficient Duty Cycle	
	Computer	Monitor
Off	77%	57%
Sleep	2%	2%
Idle	13%	N/A
Active	3%	19%

PowerState = Power (W) consumption in each power state¹⁷⁵⁰

Computer Power State	Power Draw (Watts)		
	Desktop Computer	Laptop Computer	Monitor
Unplugged	0.0	0.0	0.0
Off	0.9	0.5	0.23
Sleep	2.1	0.9	0.32
Idle	39.9	8.9	N/A
Active	72.2	60.0	14.43

For example: Computer Savings:

$$\text{kWh savings} = (\text{UECCompBase} - \text{UECCompEff})$$

$$\text{UECCompBase} = 0 \times 5\% \times 8,760 + 0.9 \times 55\% \times 8,760 + 2.1 \times 2\% \times 8,760 + 39.9 \times 35\% \times 8,760 + 72.2 \times 3\% \times 8,760 = 146.2 \text{ kWh}$$

$$\text{UECCompEff} = 0 \times 5\% \times 8,760 + 0.9 \times 77\% \times 8,760 + 2.1 \times 2\% \times 8,760 + 39.9 \times 13\% \times 8,760 + 72.2 \times 3\% \times 8,760 = 70.5 \text{ kWh}$$

$$\text{Computer kWh savings} = (146.2 - 70.5) = 75.7 \text{ kWh}$$

For example: Laptop Savings:

$$\text{UECCompBase} = 0 \times 5\% \times 8,760 + 0.5 \times 55\% \times 8,760 + 0.9 \times 2\% \times 8,760 + 8.9 \times 35\% \times 8,760 + 60.0 \times 3\% \times 8,760 = 45.6 \text{ kWh}$$

$$\text{UECCompEff} = 0 \times 5\% \times 8,760 + 0.5 \times 77\% \times 8,760 + 0.9 \times 2\% \times 8,760 + 8.9 \times 13\% \times 8,760 + 60.0 \times 3\% \times 8,760 = 29.4 \text{ kWh}$$

$$\text{Laptop kWh savings} = (45.6 - 29.4) = 16.2 \text{ kWh}$$

For example: Monitor Savings (assuming CPMS is controlling 2 monitors):

$$\text{Monitor kWh savings} = (\text{UECMonBase} - \text{UECMonEff})$$

$$\text{UECMonBase} = (2 \times 0 \times 22\% \times 8,760 + 2 \times 0.23 \times 50\% \times 8,760 + 2 \times 0.32 \times 2\% \times 8,760 + 2 \times 14.43 \times 26\% \times 8,760) / 1,000 = 67.9 \text{ kWh}$$

$$\text{UECMonEff} = (2 \times 0 \times 22\% \times 8,760 + 2 \times 0.23 \times 57\% \times 8,760 + 2 \times 0.32 \times 2\% \times 8,760 + 2 \times 14.43 \times 19\% \times 8,760) / 1,000 = 50.5 \text{ kWh}$$

$$\text{Monitor kWh savings} = (67.9 - 50.5) = 17.4 \text{ kWh}$$

SUMMER COINCIDENT PEAK DEMAND SAVINGS

$$\Delta \text{kW} = \Delta \text{kWh} / 8,760$$

¹⁷⁵⁰ Northwest Regional Technical Forum Non-Res Network Computer Power Management , January 29, 2015. Analysis can be found in NonResNetCompPwrMgt_v4_1.xlsm. <https://rtf.nwcouncil.org/measure/non-res-network-computer-power-management>

Computer peak kW savings	= 75.7/8760	= 0.009 kW
Laptop peak kW savings	= 16.2/8760	= 0.002 kW
Monitor (assuming CPMS is controlling 2 monitors) peak kW savings	=17.4/8760	= 0.002 kW

FOSSIL FUEL SAVINGS

NA

WATER IMPACT DESCRIPTIONS AND CALCULATION

NA

DEEMED O&M COST ADJUSTMENT CALCULATION

For Centralized Software, assume \$2/unit. ¹⁷⁵¹

For Individual Settings, no O&M impacts.

MEASURE CODE: CI-MSC-CPMS-V04-220101

REVIEW DEADLINE: 1/1/2025

¹⁷⁵¹ Based on Dimetrosky, S., Luedtke, J. S., & Seiden, K. (2005). Surveyor Network Energy Manager: Market Progress Evaluation Report, No. 2 (Northwest Energy Efficiency Alliance report #E05-136). Portland, OR: Quantec LLC and review of CLEARResult document providing Qualifying Software Providers for ComEd program and their licensing fees; "Qualifying Vendor Software Comparison.pdf".

4.9.3 Modulating Commercial Gas Clothes Dryer

DESCRIPTION

This measure relates to the installation of a two-stage modulating gas valve retrofit kit on a standard commercial non-modulating gas dryer. Commercial gas clothes dryers found in coin-operated laundromats or on-premise laundromats (hospitals, hotels, health clubs, etc.) traditionally have a single firing rate which is sized properly for highest heat required in initial drying stages but is oversized for later drying stages requiring lesser heat. This causes the burner to cycle on/off frequently, resulting in less efficient drying and wasted gas. Replacing the single stage gas valve with a two-stage gas valve allows the firing rate to adjust to the changing heat demand, thereby reducing overall gas consumption.

This measure was developed to be applicable to the following program types: RF.

If applied to other program types, the measure savings should be verified.

DEFINITION OF EFFICIENT EQUIPMENT

A 30 to 250 pound capacity commercial gas dryer retrofitted with a two-stage modulating gas valve kit.

DEFINITION OF BASELINE EQUIPMENT

A 30 to 250 pound capacity commercial gas dryer with no modulating capabilities.

DEEMED LIFETIME OF EFFICIENT EQUIPMENT

The deemed measure life for the retrofit kit is 10 years.¹⁷⁵²

DEEMED MEASURE COST

The full retrofit cost is assumed to be \$700, including the material cost for the basic modulating gas valve retrofit kit (\$600) and the associated of labor for installation (\$100).¹⁷⁵³

LOADSHAPE

N/A

COINCIDENCE FACTOR

N/A

Algorithm

CALCULATION OF SAVINGS

ELECTRIC ENERGY SAVINGS

N/A

SUMMER COINCIDENT PEAK DEMAND SAVINGS

N/A

FOSSIL FUEL SAVINGS

Note: Accurately estimating dryer energy consumption is complicated and challenging due to a variety of factors that influence cycle times and characteristics and ultimately drying energy requirements. Clothing loads can vary by weight, volume, fiber composition, physical structure, and initial water content, meaning that for any given cycle

¹⁷⁵² Since this is a retrofit measure to an existing piece of equipment the measure life is less than the full life of the drier. Assumed to be 10 years as cost would be prohibitive for older machines that are likely to be need replacing soon.

¹⁷⁵³ Engineering judgement, based on observed costs during Nicor Gas pilot study. "Nicor Gas Emerging Technology Program, 1036: Commercial Dryer Modulation Retrofit Public Project Report." 2014.

drying energy requirements can differ. Additionally, dryer settings selected by the user as well as interactions with the site’s HVAC systems are known to influence dryer performance. As better information becomes available, this characterization can be modified to allow for a more site-specific estimation of savings.

$$\Delta\text{Therms} = N_{\text{Cycles}} * SF$$

Where:

N_{Cycles} = Number of dryer cycles per year. Refer to the table below if this value is not directly available.

Application	Cycles per Year
Coin- Operated Laundromats ¹⁷⁵⁴	1,483
Multi-family Dryers ¹⁷⁵⁵	1,074
On-Premise Laundromats ¹⁷⁵⁶	3,607

SF = Savings factor
 = 0.18 therms/cycle¹⁷⁵⁷

If using default cycles the savings are as follows:

Application	ΔTherms
Coin- Operated Laundromats ¹⁷⁵⁸	267
Multi-family Dryers ¹⁷⁵⁹	193
On-Premise Laundromats ¹⁷⁶⁰	649

WATER IMPACT DESCRIPTIONS AND CALCULATION

N/A

DEEMED O&M COST ADJUSTMENT CALCULATION

N/A

MEASURE CODE: CI-MSC-MODD-V02-230101

REVIEW DEADLINE: 1/1/2027

¹⁷⁵⁴ From DOE’s Federal Register Notices, Energy Conservation Program: Energy Conservation Standards for Commercial Clothes Dryers, Office of Energy Efficiency & Renewable Energy.

¹⁷⁵⁵ Ibid.

¹⁷⁵⁶ Average value for dryer cycles in healthcare facility, hotels, drycleaners and laundromats from tests conducted in Nicor Gas Emerging Technology Program’s Commercial Dryer Modulation Retrofit Public Project Report.

¹⁷⁵⁷ Based on Illinois weather data, and average dryer performance for laundromat (30 to 45lb) and hotel (75 to 170 lb) dryers. See GTI Analysis.xlsx for complete derivation.

¹⁷⁵⁸ From DOE’s Federal Register Notices, Energy Conservation Program: Energy Conservation Standards for Commercial Clothes Dryers, Office of Energy Efficiency & Renewable Energy.

¹⁷⁵⁹ Ibid.

¹⁷⁶⁰ Average value for dryer cycles in healthcare facility, hotels, drycleaners and laundromats from tests conducted in Nicor Gas Emerging Technology Program’s Commercial Dryer Modulation Retrofit Public Project Report.

4.9.4 High Speed Clothes Washer

DESCRIPTION

This measure applies to the installation of clothes washers with extraction speeds of 200G or greater, which is significantly higher than traditional hard-mount washers. Standard washer extractors in laundromats operate at speeds of 70-80G¹⁷⁶¹. The high-speed extraction process in the wash cycle removes more water from each compared to standard washers, reducing operating time and gas consumption of clothes dryers. Heat exposure and mechanical action are also reduced, resulting in less linen wear.

This measure was developed to be applicable to the following program types: TOS, NC, EREP. If applied to other program types, the measure savings should be verified.

DEFINITION OF EFFICIENT EQUIPMENT

The efficient equipment is assumed to be a clothes washer with an extraction speed of 200G or greater, installed in a commercial laundromat. This measure is only applicable for sites utilizing gas dryers. Sites using electric dryers are not eligible for participation.

DEFINITION OF BASELINE EQUIPMENT

The baseline equipment is assumed to be a clothes washer with an extraction speed of 100G or less, installed in a commercial laundromat.

DEEMED LIFETIME OF EFFICIENT EQUIPMENT

The measure lifetime is assumed to be the typical lifetime of a commercial clothes washer: 7 years.¹⁷⁶²

For early replacement measures it is assumed the existing unit would last another 2.3 years.¹⁷⁶³

DEEMED MEASURE COST¹⁷⁶⁴

The incremental cost for time of sale is \$11.83/lb capacity.

The full cost of the high speed washer for early replacement applications is \$201.10/lb capacity. The deferred replacement cost of the baseline unit is \$189.27/lb capacity. This future cost should be discounted to present value using the real discount rate.

LOADSHAPE

N/A

COINCIDENCE FACTOR

N/A

Algorithm

CALCULATION OF SAVINGS

ELECTRIC ENERGY SAVINGS

N/A

¹⁷⁶¹ “The Real Size of a Front Load Washer”, Laundromat123

¹⁷⁶² “Assessment of Water Savings for Commercial Washers: Report on the Monitoring and Assessment of Water Savings from the Coin-Operated Multi-Load Clothes Washers Voucher Initiative Program.” San Diego County Water Authority October 2016.

¹⁷⁶³ One-third of expected measure life.

¹⁷⁶⁴ Measure costs are based on data from a 2016 quote provided by a commercial washer distributor to Franklin Energy Services, adjusted for inflation.

SUMMER COINCIDENT PEAK DEMAND SAVINGS

N/A

FOSSIL FUEL SAVINGS

$$\Delta\text{Therms} = (\text{Ncycles} * \text{Days} * \text{Capacity} * \text{RMC} * h_e / \eta_{\text{dryer}} / 100,000) * \text{DryerUse} * \text{LF}$$

Where:

Ncycles = Average number of washer cycles per day

= Use values from table below, depending on application

Application	Ncycles
Coin-operated Laundromats	4.3 ¹⁷⁶⁵
Multifamily	3.4 ¹⁷⁶⁶
Hotel/Motel/Hospital	10.4 ¹⁷⁶⁷

Days = Days per year of commercial laundromat operation

= Actual, or if unknown, assume 360 days¹⁷⁶⁸

Capacity = Clothes washer rated capacity (lb/cycle)¹⁷⁶⁹

= Actual

RMC = Retained Moisture Content (%)¹⁷⁷⁰ reduction from replacing a low extraction speed washer

Washer Upgrade	RMC
100G to 200G	0.15 ¹⁷⁷¹
100G to 400G	0.25 ¹⁷⁷²
200G to 400G	0.10 ¹⁷⁷³

¹⁷⁶⁵“2014-2015 State of the Self-Service Laundry Industry Report.” Carlo Calma, April 13, 2015.

¹⁷⁶⁶ “Assessment of Water Savings for Commercial Washers: Report on the Monitoring and Assessment of Water Savings from the Coin-Operated Multi-Load Clothes Washers Voucher Initiative Program.” San Diego County Water Authority October 2016.

¹⁷⁶⁷ “Laundry Planning Guide.” EDRO, January 2015.

¹⁷⁶⁸ Based on professional judgement, assuming closed on holidays.

¹⁷⁶⁹ Clothes washer capacity is based on weight of dry clothing.

¹⁷⁷⁰ The EDRO “Laundry Planning Guide” describes moisture retention as “the ratio of retained moisture weight to clean dry textile weight.” The pounds of water retained by clothing at the end of a wash cycle is calculated by multiplying Capacity (lbs of dry clothing per cycle) by RMC.

¹⁷⁷¹ Using chart provided (Figure 1) and assuming a 50/50 cloth blend load of cotton and polyester, the retained moisture drops from approximately 65% to 50% when a 100 g washer is replaced with a 200 g washer. Chart from “Laundry Planning Guide.” EDRO, January 2015. The Department of Energy test procedures for commercial clothes washers specifies, “...the use of energy test cloth consisting of a pure finished bleach cloth, made with a momie or granite weave, which is a blended fabric of 50-percent cotton and 50-percent polyester.” – Energy Conservation Program: Energy Conservation Standards for Commercial Clothes Washers; Final Rule, Notice of Proposed Rulemaking, DOE, March 2014 (10 CFR Part 431).

¹⁷⁷² Using chart provided (Figure 1) and assuming a 50/50 cloth blend load of cotton and polyester, retained moisture drops from approximately 65% to 40% when a 100 g washer is replaced with a 400 g washer.

¹⁷⁷³ Using chart provided (Figure 1) and assuming a 50/50 cloth blend load of cotton and polyester, retained moisture drops from approximately 50% to 40% when a 200 g washer is replaced with a 400 g washer.

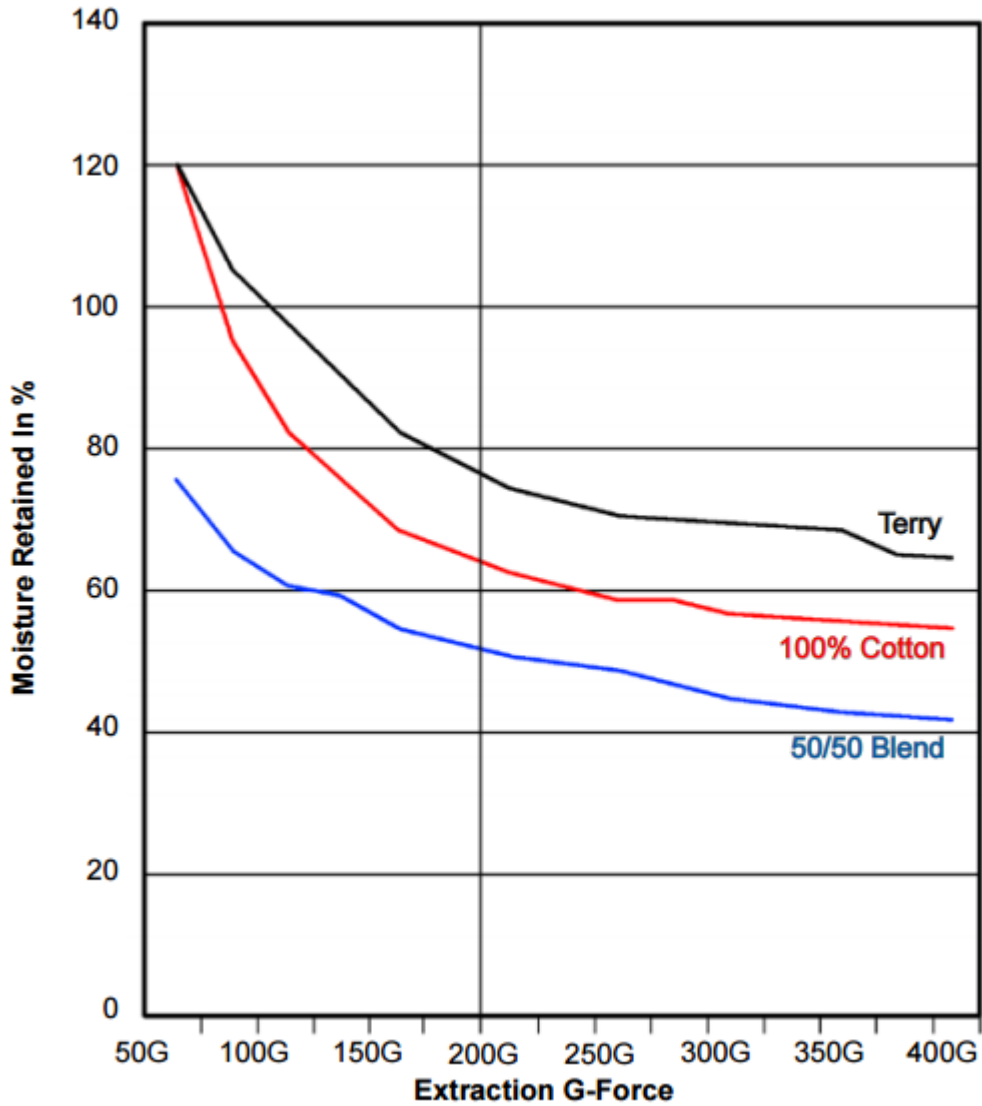

Figure 1

h_e = Heat required by a dryer to evaporate 1 lb of water

= Assume 1,200 Btu/lb¹⁷⁷⁴

η_{dryer} = Efficiency of the clothes dryer

= Actual, or if unknown, assume 60%¹⁷⁷⁵

100,000 = Converts Btus to therms

DryerUse = % of washer loads dried in the field

= Assume 91%¹⁷⁷⁶

LF = Load Factor (%) to account for the pounds per washer load, as a percentage of rated capacity

¹⁷⁷⁴ "Laundry Planning Guide." EDRO, January 2015.

¹⁷⁷⁵ ACEEE (2010), "Are We Missing Energy Savings in Clothes Dryers?" Paul Bendt (Ecos), 2010

¹⁷⁷⁶ "Dryer Field Study." Northwest Energy Efficiency Alliance, November 20, 2014.

= Assume 66%¹⁷⁷⁷

For example, a clothes washer with a 14 lb/cycle capacity and installed at a coin-operated laundromat, using default assumptions, would save:

$$\begin{aligned}\Delta\text{Therms} &= (\text{Ncycles} * \text{Days} * \text{Capacity} * \text{RMC} * h_e / \eta_{\text{dryer}} / 100,000) * \text{DryerUse} * \text{LF} \\ &= (4.3 * 360 * 14 * 0.25 * 1,200 / 0.60 / 100,000) * 0.91 * 0.66 \\ &= 65 \text{ therms}\end{aligned}$$

WATER AND OTHER NON-ENERGY IMPACT DESCRIPTIONS AND CALCULATION

N/A

DEEMED O&M COST ADJUSTMENT CALCULATION

N/A

MEASURE CODE: CI-MSC-HSCW-V04-250101

REVIEW DEADLINE: 1/1/2028

¹⁷⁷⁷“Assessment of Water Savings for Commercial Washers: Report on the Monitoring and Assessment of Water Savings from the Coin-Operated Multi-Load Clothes Washers Voucher Initiative Program.” San Diego County Water Authority October 2016.

4.9.5 ENERGY STAR Computers

DESCRIPTION

This measure estimates savings for a desktop computer with ENERGY STAR (ES) Version 8.0 rating, ES 8.0 +20%, ES 8.0 with 80 PLUS Platinum PSUs, and ES 8.0 with 80 PLUS Titanium PSUs.

This measure was developed to be applicable to the following program types: TOS. If applied to other program types, the measure savings should be verified.

DEFINITION OF EFFICIENT EQUIPMENT

The efficient product is a desktop with a rating of ENERGY STAR Version 8.0 rating, ES 8.0 +20%, ES 8.0 with 80 PLUS Platinum PSUs, or ES 8.0 with 80 PLUS Titanium PSUs.

DEFINITION OF BASELINE EQUIPMENT

Non ENERGY STAR qualified equipment with standard efficiency power supply.

DEEMED LIFETIME OF EFFICIENT EQUIPMENT

The life of this measure is 4 years.¹⁷⁷⁸

DEEMED MEASURE COST¹⁷⁷⁹

The incremental cost for an 80 Plus Desktop PSU is \$5.
The incremental cost for an ENERGY STAR desktop PSU is \$20.

LOADSHAPE

C21 Commercial Office Equipment

COINCIDENCE FACTOR

N/A

Algorithm

CALCULATION OF ENERGY SAVINGS

ELECTRIC ENERGY SAVINGS¹⁷⁸⁰

$$\Delta kWh = 8760/1000 * (((Watts_{Base,Off} * \%Time_{Off}) + (Watts_{Base,Sleep} * \%Time_{Sleep}) + (Watts_{Base,Long} * \%Time_{Long}) + (Watts_{Base,Short} * \%Time_{Short})) - ((Watts_{Eff,Off} * \%Time_{Off}) + (Watts_{Eff,Sleep} * \%Time_{Sleep}) + (Watts_{Eff,Long} * \%Time_{Long}) + (Watts_{Eff,Short} * \%Time_{Short})))$$

Where (see assumptions in table below):

8760/1000	= Converts W to kWh
Watts _{Base,Off}	= baseline equipment power in off mode
%Time _{Off}	= typical percent of time a desktop, integrated desktop or notebook is in off mode during the year
Watts _{Base,Sleep}	= baseline equipment power in sleep mode
%Time _{Sleep}	= typical percent time in sleep mode

¹⁷⁷⁸ Codes and Standards Enhancement (CASE) Initiative For PY 2013: Title 20 Standards Development. Analysis of Standards Proposal for Computers, August 6, 2013. Section 2.3 Design Life, Page 15.

¹⁷⁷⁹ NEEA Research Into Action, 80 PLUS Market Progress Evaluation Report #5, November 26, 2013. Page 24.

¹⁷⁸⁰ ENERGY STAR Program Requirements for Computers - Eligibility Criteria v8.0, Section 3.5.2.v., Equation 1: TEC Calculation (ETEC) for Desktop, Integrated Desktop, and Notebook Computers, pg 12.

- Watts_{Base,Long} = baseline equipment power in long idle mode
- %Time_{Long} = typical percent time in long idle mode
- Watts_{Base,Short} = baseline equipment power in short idle mode
- %Time_{Short} = typical percent time in short idle mode
- Watts_{Eff,Off} = efficient equipment power in off mode
- Watts_{Eff,Sleep} = efficient equipment power in sleep mode
- Watts_{Eff,Long} = efficient equipment power in long idle mode
- Watts_{Eff,Short} = efficient equipment power in short idle mode

Measure Annual Mode Time (%)	Off	Sleep	Long Idle	Short Idle
Duty cycle – Commercial Desktop ¹⁷⁸¹	15%	45%	10%	30%

Measure Watt Draw in Mode (Watts)	Off	Sleep	Long Idle	Short Idle
Baseline ¹⁷⁸²	0.88	2.1	26.5	27.9
ES 8.0 Desktops ¹⁷⁸³	0.64	1.54	14.97	19.62
ES 8.0 +20% Desktops ¹⁷⁸⁴	0.64	1.53	14.47	19.22
ES 8.0 Desktops w/ 80 PLUS Platinum PSUs ¹⁷⁸⁵	0.50	1.50	13.97	18.30
ES 8.0 Desktops w/ 80 PLUS Titanium PSUs ¹⁷⁸⁶	0.50	1.50	13.67	17.91

Calculated energy consumption in each mode, and savings provided below:

Measure TEC by Mode - Commercial	Off	Sleep	Long Idle	Short Idle	TEC (kWh/yr)	Savings (kWh/yr)
Baseline	1.2	8.3	23.2	73.3	106.0	N/A
ES 8.0 Desktops	0.8	6.1	13.1	51.6	71.6	34.4
ES 8.0 +20% Desktops	0.8	6.0	12.7	50.5	70.1	35.9
ES 8.0 Desktops w/ 80 PLUS Platinum PSUs	0.7	5.9	12.2	48.1	66.9	39.1
ES 8.0 Desktops w/ 80 PLUS Titanium PSUs	0.7	5.9	12.0	47.1	65.6	40.3

¹⁷⁸¹ ENERGY STAR Program Requirements for Computers - Eligibility Criteria v8.0, Section 3.5.2.v., Table 4: Mode Weightings for Desktops and Integrated Desktop Computers, pg 13.

¹⁷⁸² Codes and Standards Enhancement (CASE) Initiative For PY 2013: Title 20 Standards Development. Computers: Technical Report - Supplemental Analysis and Test Results, January 21, 2014.

¹⁷⁸³ Analysis of current DT I2 Category Desktops in the ENERGY STAR version 8.0 Qualified Products List (QPL) as accessed on 5/6/2020 (see File "ENERGY STAR_Computers_Analysis_2020.xlsx", Sheet "DT I2 Stats").

¹⁷⁸⁴ Analysis of current DT I2 Category Desktops in the ENERGY STAR version 8.0 Qualified Products List (QPL), passing with > 20% margin, as accessed on 5/6/2020 (see File "ENERGY STAR_Computers_Analysis_2020.xlsx", Sheet "DT I2 Stats").

¹⁷⁸⁵ 80 PLUS program savings calculator, additional 7% reduction in idle power levels over ENERGY STAR version 7.0 computers with 80 PLUS Silver PSU levels. The program calculator was used to establish relative and comparable savings, and as a result, absolute idle power values do not match. For more details on the derivation of the 6.7% savings factor, please see, "80 PLUS Desktop Savings_25Aug2014_Revised ESv8.xlsx", 'Analysis Summary' tab.

¹⁷⁸⁶ 80 PLUS program savings calculator, additional 9.1% reduction in idle power levels over ENERGY STAR version 7.0 computers with 80 PLUS Silver PSU levels. The program calculator was used to establish relative and comparable savings, and as a result, absolute idle power values do not match. For more details on the derivation of the 8.7% savings factor, please see, "80 PLUS Desktop Savings_25Aug2014_Revised ESv8.xlsx", 'Analysis Summary' tab.

Savings calculations can be referenced in “ENERGY STAR Computers Analysis_2020_Revised.xlsx”

SUMMER COINCIDENT PEAK DEMAND SAVINGS¹⁷⁸⁷

$$\Delta kW = (\text{Watts}_{\text{Base}} - \text{Watts}_{\text{Eff}}) / 1000 * CF$$

Where:

Watts_{Base} = Assumed average baseline wattage during peak period (see table below)

Watts_{Eff} = Assumed average efficient wattage during peak period (see table below)

CF = Summer Peak Coincidence Factor

= 1.0

Calculated average demand during peak period, and savings provided below:

Measure Demand Reduction by Mode	TEC (Watts)	Long Idle Demand Savings (kW)	Short Idle Demand Savings (kW)	Weighted Average Demand Savings (kW)
Baseline	14.1	N/A	N/A	N/A
ES 8.0 Desktops	9.5	0.0115	0.0083	0.0091
ES 8.0 +20% Desktops	9.3	0.0120	0.0087	0.0095
ES 8.0 Desktops w/ 80 PLUS Platinum PSUs	8.9	0.0125	0.0096	0.0103
ES 8.0 Desktops w/ 80 PLUS Titanium PSUs	8.7	0.0128	0.0100	0.0107

Please note, the last column is a weighted average of the Long & Short Idle Modes and should be the value used in calculations. All Savings calculations can be referenced in “ENERGY STAR Computers Analysis_2020_Revised.xlsx”

FOSSIL FUEL SAVINGS

N/A

WATER AND OTHER NON-ENERGY IMPACT DESCRIPTIONS AND CALCULATION

N/A

DEEMED O&M COST ADJUSTMENT CALCULATION

N/A

MEASURE CODE: CI-MSC-COMP-V03-210101

REVIEW DEADLINE: 1/1/2025

¹⁷⁸⁷ It assumed that computers will not be off during peak period, and that the weighting of sleep, long idle and short idle during peak hours is consistent with the whole year. Wattage assumptions are weighted accordingly and coincidence factor is thus assumed to be 1.0 – see “ENERGY STAR Computers Analysis_2020_Revised.xlsx” for calculation.

4.9.6 Advanced Power Strip – Tier 1 Commercial

DESCRIPTION

This measure relates to Advanced Power Strips – Tier 1 which are multi-plug power strips with the ability to automatically disconnect specific connected loads depending upon the power draw of a control load, also plugged into the strip. Power is disconnected from the switched (controlled) outlets when the control load power draw is reduced below a certain adjustable threshold, thus turning off the appliances plugged into the switched outlets. By disconnecting, the standby load of the controlled devices, the overall load of a centralized group of equipment (e.g. a desk workstation) can be reduced. In a commercial office space, savings generally occur during off-hours, when connected equipment continues to consume electricity while in standby mode or when off. Uncontrolled outlets are also provided that are not affected by the control device and so are always providing power to any device plugged into it.

This measure was developed to be applicable to the following program types: DI, Kits.

If applied to other program types, the measure savings should be verified.

DEFINITION OF EFFICIENT EQUIPMENT

The efficient case is an advanced power strip with a load-sensing master plug and at least two controlled plugs.

DEFINITION OF BASELINE EQUIPMENT

The assumed baseline is a standard power strip with surge protection that does not control connected loads.

DEEMED LIFETIME OF EFFICIENT EQUIPMENT

The assumed lifetime of the advanced power strip is 7 years.¹⁷⁸⁸

DEEMED MEASURE COST

For direct install the actual full equipment and installation cost (including labor) and for kits the actual full equipment cost should be used.

Equipment cost if unknown¹⁷⁸⁹:

Baseline Cost	Efficient Cost	Incremental Cost	Equipment
\$20	\$30	\$10	

LOADSHAPE

Loadshape C47 – Standby Losses – Commercial Office¹⁷⁹⁰

COINCIDENCE FACTOR

N/A due to no savings attributable to standby losses between 1 and 5 PM.

¹⁷⁸⁸ This is a consistent assumption with 5.2.2 Advanced Power Strip – Tier 2.

¹⁷⁸⁹ Price survey performed by Illume Advising LLC for IL TRM workpaper, see “Current Surge Protector Costs and Comparison 7-2016” spreadsheet.

¹⁷⁹⁰ Loadshapes were calculated from empirical studies and compared to the existing loadshape in Volume 1, Table 3.5. The studies were:

Acker, Brad *et al*, “Office Space Plug Load Profiles and Energy Saving Interventions,” 2012 ACEEE Summer Study on Energy Efficiency in Buildings.

Sheppy, M. *et al*, “Reducing Plug Loads in Office Spaces” Hawaii and Guam Energy Improvement Technology Demonstration Project, NREL/NAVFAC (January 2014).

Algorithm

CALCULATION OF ENERGY SAVINGS

ELECTRIC ENERGY SAVINGS

$$\Delta kWh^{1791} = ((kW_{wkday} * (hrs_{wkday} - hrs_{wkday-open})) + (kW_{wkend} * (hrs_{wkend} - hrs_{wkend-open}))) * weeks/year * ISR$$

Where:

kW_{wkday} = Standby power consumption of connected electronics on weekday off-hours. If unknown, assume 0.0315 kW.

kW_{wkend} = Standby power consumption of connected electronics on weekend off-hours. If unknown, assume 0.00617 kW.

hrs_{wkday} = total hours during the work week (Monday 7:30 AM to Friday 5:30 PM)
= 106

hrs_{wkend} = total hours during the weekend (Friday 5:30 PM to Monday 7:30 AM)
= 62

$hrs_{wkday-open}$ = hours the office is open during the work week. If unknown, assume 50 hours.

$hrs_{wkend-open}$ = hours the office is open during the weekend. If unknown, assume 0 hours.

$weeks/year$ = number of weeks per year
= 52.2

ISR = In Service Rate
= Assume 0.969 for commercial Direct Install application¹⁷⁹², or 0.71 for kit distribution¹⁷⁹³.

For example, an office open 9 hours per day (45 hours per week) on weekdays and 4 hours on Saturday:

$$\begin{aligned} \Delta kWh &= ((0.0315 * (106 - 45)) + (0.00617 * (62 - 4))) * 52.2 * 0.969 \\ &= 115 kWh \end{aligned}$$

SUMMER COINCIDENT PEAK DEMAND SAVINGS

N/A due to no savings attributable to standby losses between 1 and 5 PM.

FOSSIL FUEL SAVINGS

N/A

¹⁷⁹¹ Savings algorithm reconstructed from weekday and weekend savings information in Acker, Brad *et. al*, "Office Space Plug Load Profiles and Energy Saving Interventions," 2012 ACEEE Summer Study on Energy Efficiency in Buildings, and verified against savings in Acker *et. al* and savings in: BPA, "Smart Power Strip Energy Savings Evaluation: Ross Complex," (2011). Office stations are assumed to have zero or minimal standby losses during normal operating hours. Method shown in "Commercial Tier 1 APS Calculations – IL TRM.xlsx".

¹⁷⁹² Based upon review of the PY2 and PY3 ComEd Direct Install Residential program surveys. This value could be modified based upon commercial application evaluation.

¹⁷⁹³ Based on survey data collected from ComEd 2018 and 2019 Small Business Kits Program. The 2018 ISR was 0.592 and the 2019 ISR was 0.835, the average being 0.71.

WATER AND OTHER NON-ENERGY IMPACT DESCRIPTIONS AND CALCULATION

N/A

DEEMED O&M COST ADJUSTMENT CALCULATION

N/A

MEASURE CODE: CI-MSC-APSC-V05-240101

REVIEW DEADLINE: 1/1/2028

4.9.7 High Efficiency Transformer

DESCRIPTION

Distribution transformers are used in commercial and industrial applications to step down power from distribution voltage to be used in HVAC or process loads (220V or 480V) or to serve plug loads (120V).

Distribution transformers that are more efficient than the required minimum federal standard efficiency qualify for this measure. If there is no specific standard efficiency requirement, the transformer does not qualify (because we cannot define a reasonable baseline). For example, although the federal standards increased the minimum required efficiency in 2016, most transformers with a NEMA premium or CEE Tier 2 rating will still achieve energy conservation. Standards are defined for low-voltage dry-type distribution transformers (up to 333kVA single-phase and 1000kVA 3-phase), liquid-immersed distribution transformers (up to 833kVA single-phase and 2500kVA 3-phase), and medium-voltage dry-type distribution transformers (up to 833kVA single-phase and 2500kVA 3-phase).

This measure was developed to be applicable to the following program types: TOS, NC.

If applied to other program types, the measure savings should be verified.

DEFINITION OF EFFICIENT EQUIPMENT

Any transformer that is more efficient than the federal minimum standard. This includes CEE Tier II (single or three phase) and most NEMA premium efficiency rated products.

DEFINITION OF BASELINE EQUIPMENT

A transformer that meets the minimum federal efficiency requirement should be used as the baseline to calculate savings. Standards are developed by the Department of Energy and published in the Federal Register 10CFR 431.¹⁷⁹⁴

(a) Low-Voltage Dry-Type Distribution Transformers.

(2) The efficiency of a low-voltage dry-type distribution transformer manufactured on or after January 1, 2016, shall be no less than that required for their kVA rating in the table below. Low-voltage dry-type distribution transformers with kVA ratings not appearing in the table shall have their minimum efficiency level determined by linear interpolation of the kVA and efficiency values immediately above and below that kVA rating.

Single-phase		Three-phase	
kVA	Efficiency (%)	kVA	Efficiency (%)
15	97.70	15	97.89
25	98.00	30	98.23
37.5	98.20	45	98.40
50	98.30	75	98.60
75	98.50	112.5	98.74
100	98.60	150	98.83
167	98.70	225	98.94
250	98.80	300	99.02
333	98.90	500	99.14
		750	99.23
		1000	99.28

(b) Liquid-Immersed Distribution Transformers.

¹⁷⁹⁴ US Department of Energy, “Energy Conservation Program: Energy Conservation Standards for Distribution Transformers; Final Rule”, 10 CFR Part 431, Published April 18, 2013, Compliance effective as of January 1, 2016.

(2) The efficiency of a liquid-immersed distribution transformer manufactured on or after January 1, 2016, shall be no less than that required for their kVA rating in the table below. Liquid-immersed distribution transformers with kVA ratings not appearing in the table shall have their minimum efficiency level determined by linear interpolation of the kVA and efficiency values immediately above and below that kVA rating.

Single-phase		Three-phase	
kVA	Efficiency (%)	kVA	Efficiency (%)
10	98.70	15	98.65
15	98.82	30	98.83
25	98.95	45	98.92
37.5	99.05	75	99.03
50	99.11	112.5	99.11
75	99.19	150	99.16
100	99.25	225	99.23
167	99.33	300	99.27
250	99.39	500	99.35
333	99.43	750	99.40
500	99.49	1000	99.43
667	99.52	1500	99.48
833	99.55	2000	99.51
		2500	99.53

(c) Medium-Voltage Dry-Type Distribution Transformers.

(2) The efficiency of a medium-voltage dry-type distribution transformer manufactured on or after January 1, 2016, shall be no less than that required for their kVA and BIL rating in the table below. Medium-voltage dry-type distribution transformers with kVA ratings not appearing in the table shall have their minimum efficiency level determined by linear interpolation of the kVA and efficiency values immediately above and below that kVA rating.

Single-phase				Three-phase			
kVA	BIL*			kVA	BIL		
	20-45 kV	46-95 kV	≥96 kV		20-45 kV	46-95 kV	≥96 kV
	Efficiency (%)	Efficiency (%)	Efficiency (%)		Efficiency (%)	Efficiency (%)	Efficiency (%)
15	98.10	97.86		15	97.50	97.18	
25	98.33	98.12		30	97.90	97.63	
37.5	98.49	98.30		45	98.10	97.86	
50	98.60	98.42		75	98.33	98.13	
75	98.73	98.57	98.53	112.5	98.52	98.36	
100	98.82	98.67	98.63	150	98.65	98.51	
167	98.96	98.83	98.80	225	98.82	98.69	98.57
250	99.07	98.95	98.91	300	98.93	98.81	98.69
333	99.14	99.03	98.99	500	99.09	98.99	98.89
500	99.22	99.12	99.09	750	99.21	99.12	99.02
667	99.27	99.18	99.15	1000	99.28	99.20	99.11
833	99.31	99.23	99.20	1500	99.37	99.30	99.21
				2000	99.43	99.36	99.28
				2500	99.47	99.41	99.33

DEEMED LIFETIME OF EFFICIENT EQUIPMENT

30 years¹⁷⁹⁵

DEEMED MEASURE COST

Actual incremental costs should be used.

LOADSHAPE

Use custom loadshape based on application; default loadshape is Loadshape C67 (Ameren) or C68 (ComEd), which represent overall utility system loads.

COINCIDENCE FACTOR

Coincidence Factor for distribution transformers is 1.0 by definition. By including the load factor in the demand savings calculation, the load profile is accounted for.

Algorithm

CALCULATION OF ENERGY SAVINGS

Savings are determined by metering equipment

ELECTRIC ENERGY SAVINGS

$$\Delta kWh = Losses_{base} - Losses_{EE}$$

Where:

$$Losses_{base} = PowerRating * LF * PF * \left(\frac{1}{EFF_{base}} - 1 \right) * 8766$$

$$Losses_{EE} = PowerRating * LF * PF * \left(\frac{1}{EFF_{EE}} - 1 \right) * 8766$$

PowerRating = kVA rating of the transformer (in units of kVA)

EFF_{base} = baseline total efficiency rating of federal minimum standard transformer (refer to baseline tables above based on kVA, voltage, and type of transformer)

EFF_{EE} = actual total efficiency rating of the transformer as calculated by the appropriate DOE test method.¹⁷⁹⁶

LF = Load Factor for the transformer. Ratio of average transformer load to peak load rating over a period of one year. Use actual load factor for the network segment served based on historical data. If unknown, use 22% for commercial load and 45% for industrial load.¹⁷⁹⁷

PF = Power Factor for the load being served by the transformer. Ratio of real power to apparent power supplied to the transformer. Use actual power factor for the network segment served. If unknown, use 1.0 (unity) by default.¹⁷⁹⁸

¹⁷⁹⁵ US DOE lists lifetime at 32 years. For consistency with efficiency measure evaluated lifetimes, 30 years is the recommended maximum deemed lifetime. US Department of Energy, “Energy Conservation Program: Energy Conservation Standards for Distribution Transformers; Final Rule”, 10 CFR Part 431, Published April 18, 2013, Effective as of January 1, 2016.

¹⁷⁹⁶ Energy Conservation Program: Test Procedures for Distribution Transformers; Final Rule. Effective May 30, 2006.

¹⁷⁹⁷ Guidelines on The Calculation and Use of Loss Factors, Electric Authority, Te Mana Hiko, February 14, 2013.

¹⁷⁹⁸ Unity power factor for used as default value, as used in the test procedures provided by US DOE. Energy Conservation Program: Test Procedures for Distribution Transformers; Final Rule. Effective May 30, 2006.

SUMMER COINCIDENT PEAK DEMAND SAVINGS

$$\Delta kW = \text{PowerRating} * \text{LF} * \text{PF} * \left(\frac{1}{\text{Eff}_{base}} - \frac{1}{\text{Eff}_{EE}} \right)$$

Variables as provided above.

FOSSIL FUEL SAVINGS

N/A

WATER AND OTHER NON-ENERGY IMPACT DESCRIPTIONS AND CALCULATION

N/A

DEEMED O&M COST ADJUSTMENT CALCULATION

N/A

MEASURE CODE: CI-MSC-TRNS-V03-220101

REVIEW DEADLINE: 1/1/2025

4.9.8 High Frequency Battery Chargers

DESCRIPTION

This measure applies to industrial high frequency battery chargers, used for industrial equipment such as fork lifts, replacing existing SCR (silicon controlled rectifier) or ferroresonant charging technology. High frequency battery chargers have a greater system efficiency.

This measure was developed to be applicable to the following program types: TOS, NC, EREP. If applied to other program types, the measure savings should be verified.

DEFINITION OF EFFICIENT EQUIPMENT

High frequency battery charger systems with minimum Power Conversion Efficiency of 90% and a minimum 8-hour shift operation five days per week.

DEFINITION OF BASELINE EQUIPMENT

SCR or ferroresonant battery charger systems with minimum 8-hour shift operation five days per week.

DEEMED LIFETIME OF EFFICIENT EQUIPMENT

15 years¹⁷⁹⁹

DEEMED MEASURE COST

The deemed incremental measure cost is \$813.¹⁸⁰⁰

LOADSHAPE

Loadshape C14 - Indust. 1-shift (8/5) (e.g., comp. air, lights)

Loadshape C15 - Indust. 2-shift (16/5) (e.g., comp. air, lights)

Loadshape C16 - Indust. 3-shift (24/5) (e.g., comp. air, lights)

Loadshape C17 - Indust. 4-shift (24/7) (e.g., comp. air, lights)

COINCIDENCE FACTOR

The coincidence factor is assumed to be 0.0 for 1 and 2-shift operation and 1.0 for 3 and 4-shift operation.¹⁸⁰¹

Algorithm

ELECTRIC ENERGY SAVINGS

$$\Delta \text{kWh} = (\text{CAP} * \text{DOD}) * \text{CHG} * (\text{CR}_B / \text{PC}_B - \text{CR}_{EE} / \text{PC}_{EE})$$

Where:

CAP = Capacity of Battery

= Use actual battery capacity, otherwise use a default value of 35 kWh¹⁸⁰²

DOD = Depth of Discharge

¹⁷⁹⁹ Suzanne Foster Porter et al., "Analysis of Standards Options for Battery Charger Systems", (PG&E, 2010), 45.

¹⁸⁰⁰ Franklin Energy, Field Study of Industrial High Frequency Battery Chargers (2017), pg 9. Weighted average applied between FR and SCR market split.

¹⁸⁰¹ Emerging Technologies Program Application Assessment Report #0808, Industrial Battery Charger Energy Savings Opportunities, Pacific Gas & Electric. May 29, 2009.

¹⁸⁰² Jacob V. Renquist, Brian Dickman, and Thomas H. Bradley, "Economic Comparison of fuel cell powered forklifts to battery powered forklifts", International Journal of Hydrogen Energy Volume 37, Issue 17, (2012): 2.

= Use actual depth of discharge, otherwise use a default value of 80%.¹⁸⁰³

CHG = Number of Charges per year

= Use actual number of annual charges, if unknown use values below based on the type of operations¹⁸⁰⁴

Standard Operations	Number of Charges per year
1-shift (8 hrs/day – 5 days/week)	520
2-shift (16 hrs/day – 5 days/week)	1040
3-shift (24 hrs/day – 5 days/week)	1560
4-shift (24 hrs/day – 7 days/week)	2184

CR_B = Baseline Charge Return Factor

= Actual existing (early replacement) or if unknown assume 1.1613¹⁸⁰⁵

PC_B = Baseline Power Conversion Efficiency

= Actual existing (early replacement) or if unknown assume 0.85¹⁸⁰⁶

CR_{EE} = Efficient Charge Return Factor

= Actual or 1.1500¹⁸⁰⁷ if unknown

PC_{EE} = Efficient Power Conversion Efficiency

= Actual or 0.92¹⁸⁰⁸ if unknown

Default savings using defaults provided above are provided below:

Standard Operations	ΔkWh
1-shift (8 hrs/day – 5 days/week)	1,692
2-shift (16 hrs/day – 5 days/week)	3,383
3-shift (24 hrs/day – 5 days/week)	5,075
4-shift (24 hrs/day – 7 days/week)	7,104

SUMMER COINCIDENT PEAK DEMAND SAVINGS

$$\Delta kW = (PF_{EE} * PC_{EE} - PF_B * PC_B) * Volts_{DC} * Amps_{DC} / 1000 * CF$$

Where:

PF_B = Power factor of baseline charger

= Actual existing (early replacement) or if unknown assume 0.8600¹⁸⁰⁹

PF_{EE} = Power factor of high frequency charger

¹⁸⁰³ Ryan Matley, “Measuring Energy Efficiency Improvements in Industrial Battery Chargers”, (ESL-IE-09-05-32, Energy Technology Conference, New Orleans, LA, May 12-15, 2009), 4.

¹⁸⁰⁴ Number of charges is derived from the following reference and adjusted to the hours and days of the different types of shift operations. These values are based on an estimated 2-charge per 8-hour workday. See reference file Ryan Matley, “Measuring Energy Efficiency Improvements in Industrial Battery Chargers”, (ESL-IE-09-05-32, Energy Technology Conference, New Orleans, LA, May 12-15, 2009), 4.

¹⁸⁰⁵ Ecos Consulting, “Emerging Technologies Program Application Assessment Report #0808” (2009), pg. 8

¹⁸⁰⁶ Ibid.

¹⁸⁰⁷ Ibid.

¹⁸⁰⁸ Ibid.

¹⁸⁰⁹ Ibid.

= Actual or 0.9600¹⁸¹⁰ if unknown

Volts_{DC} = Actual DC rated voltage output of charger (assumed baseline charger is replaced with same rated high frequency unit)

= Use actual battery DC voltage rating, otherwise use a default value of 48 volts.¹⁸¹¹

Amps_{DC} = Actual DC rated amperage output of charger (assumed baseline charger is replaced with same rated high frequency unit)

= Use actual battery DC ampere rating, otherwise use a default value of 81 amps.¹⁸¹²

1,000 = watt to kilowatt conversion factor

CF = Summer Coincident Peak Factor for this measure

= 0.0 (for 1 and 2-shift operation)¹⁸¹³

= 1.0 (for 3 and 4-shift operation)¹⁸¹⁴

Other variables as provided above.

Default savings using defaults provided above are provided below:

Standard Operations	ΔkW
1-shift (8 hrs/day – 5 days/week)	0
2-shift (16 hrs/day – 5 days/week)	0
3-shift (24 hrs/day – 5 days/week)	0.27209
4-shift (24 hrs/day – 7 days/week)	0.27209

FOSSIL FUEL SAVINGS

N/A

WATER IMPACT DESCRIPTIONS AND CALCULATION

N/A

DEEMED O&M COST ADJUSTMENT CALCULATION

N/A

MEASURE CODE: CI-MSC-BACH-V04-250101

REVIEW DEADLINE: 1/1/2030

¹⁸¹⁰ Ibid.

¹⁸¹¹ Voltage rating based on the assumption of 35kWh battery with a normalized average amp-hour capacity of 760 Ah charged over a 7.5 hour charge cycle. Pacific Gas & Electric, “Emerging Technologies Program Application Assessment Report #0808”, Industrial Battery Charger Energy Savings Opportunities. May 29, 2009. Page 8, Table 3.

¹⁸¹² Ampere rating based on the assumption of 35kWh battery with a normalized average amp-hour capacity of 760 Ah charged over a 7.5 hour charge cycle. Pacific Gas & Electric, “Emerging Technologies Program Application Assessment Report #0808”, Industrial Battery Charger Energy Savings Opportunities. May 29, 2009. Page 8, Table 3.

¹⁸¹³ Emerging Technologies Program Application Assessment Report #0808, Industrial Battery Charger Energy Savings Opportunities, Pacific Gas & Electric. May 29, 2009.

¹⁸¹⁴ Ibid.

4.9.9 Commercial Clothes Dryer Moisture Sensor

DESCRIPTION

This measure applies to moisture sensing controllers installed on new or existing commercial natural gas clothes dryers controlled electronically. Moisture controllers detect when the load is dry, which will stop the cycle from consuming additional energy. Some new commercial dryers utilize moisture sensors, but the majority of older dryers, as well as many new models, still do not utilize moisture sensors. In a commercial dryer, when a load is drying, the heat will run completely on in the early stages. Then, it begins to cycle on and off more frequently as the load becomes drier. Traditional moisture sensors use a conductivity strip in the dryer drum. The wet load will contact the strip that completes the circuit. When the load is dry, the circuit is shorted that completes the drying cycle. Instead, this technology is a “plug and play” retrofit controller that uses patent-pending software to determine when the load is dry. When the load is dry, it overrides the existing controls to end the cycle, which shuts the drying cycle. This measure does not apply to mechanical timer dryers or to dryers with modulating valves installed.

Natural gas energy savings will be achieved by reduced drying times and correspondingly reduced natural gas consumption. Electric savings will also be achieved by reduced operating times.

This measure was developed to be applicable to following facility types:

- Hotel/Motel
- Miscellaneous - Fitness and Recreational Sports Centers
- Hospital
- Assisted Living Facilities
- Miscellaneous - Dry cleaning
- Multifamily

Moisture sensing controller retrofits could create significant energy savings opportunities at other larger facility types with on-premise laundry operations (such as correctional facilities, universities, and staff laundries); however, the results included in this analysis are based heavily on past project data for the applicable facility types listed above and may not apply to facilities outside of this list due to variances in number of loads and average pound (lbs.) capacity per project site. Projects at these facilities should continue to be evaluated through custom programs and the applicable facility types and the resulting analysis should be updated based on new information.

This measure was developed to be applicable to the following program types: RF. If applied to other program types, the measure savings should be verified.

DEFINITION OF EFFICIENT EQUIPMENT

A retrofit moisture controlling technology is added to new or existing commercial natural gas clothes dryers. Existing facilities must be able to confirm that they do not have moisture sensors (conductive strip type) or modulating gas valves installed on clothes dryers already before proceeding with the installation of this technology.

DEFINITION OF BASELINE EQUIPMENT

The baseline equipment is a conventional natural gas clothes dryer without a moisture sensor or a modulating gas valve installed.

DEEMED LIFETIME OF EFFICIENT EQUIPMENT

The equipment effective useful life (EUL) is 10 years.¹⁸¹⁵

¹⁸¹⁵ Since this is a retrofit measure to an existing piece of equipment the measure life is less than the full life of the drier. Assumed to be 10 years as cost would be prohibitive for older machines that are likely to need replacing soon.

DEEMED MEASURE COST

The full retrofit cost is assumed to be \$600, including the material cost for the basic moisture control retrofit (\$500) and the associated labor for installation (\$100).¹⁸¹⁶

LOADSHAPE

Loadshape C55; Commercial Clothes Washer

COINCIDENCE FACTOR

The coincidence factor for this measure is dependent on the application:

Application	Coincidence Factor ¹⁸¹⁷
Multi-family Dryers	0.15
On-Premise Laundromats	0.52

Algorithm

CALCULATION OF ENERGY SAVINGS

ELECTRIC ENERGY SAVINGS

Electric energy savings are per retrofitted dryer.

$$\Delta kWh = N_{Cycles} * SF$$

Where:

N_{Cycles} = Number of dryer cycles per year. Refer to the table below if this value is not directly available from the facility.

Application	Cycles per Dryer Per Year
Multi-family Dryers ¹⁸¹⁸	1,074
On-Premise Laundromats ¹⁸¹⁹	3,607

SF = Savings factor
 = 0.16 kWh/cycle¹⁸²⁰

If using default cycles the savings are as follows:

Application	ΔkWh per Dryer
Multi-family Dryers	171.8
On-Premise Laundromats	577.1

¹⁸¹⁶ Based on Gas Technology Institute’s analysis of cost data from “Nicor Gas Emerging Technology Program, 1069: Moisture Sensor Retrofit, Comprehensive Pilot Assessment Report,” May 1, 2017.

¹⁸¹⁷ In the absence of loadshape information for commercial applications, this is estimated by adjusting the residential coincidence factor proportionately by the relative number of loads (264 for residential and as described in this measure for commercial applications).

¹⁸¹⁸ From DOE’s Federal Register Notices - found here: <http://energy.gov/eere/buildings/recent-federal-register-notice>

¹⁸¹⁹ Average value for dryer cycles in healthcare facility, hotels, drycleaners and laundromats from tests conducted in Nicor Gas Emerging Technology Program’s Commercial Dryer Modulation Retrofit Public Project Report.

¹⁸²⁰ Savings factor based on engineering analysis of savings data from “Nicor Gas Emerging Technology Program, 1069: Moisture Sensor Retrofit, Comprehensive Pilot Assessment Report,” May 1, 2017 and “Advanced Commercial Clothes Dryer Technologies Field Test,” prepared by Gas Technology Institute for the Minnesota Department of Commerce, January 15, 2018.

SUMMER COINCIDENT PEAK DEMAND SAVINGS

$$\Delta kW = \Delta kWh / \text{Hours} * CF$$

Where:

Hours = Assumed Run hours of Clothes Dryer¹⁸²¹

Application	Hours
Multi-family Dryers	806
On-Premise Laundromats	2,705

CF = Summer Peak Coincidence Factor for measure.

Application	Coincidence Factor ¹⁸²²
Multi-family Dryers	0.15
On-Premise Laundromats	0.52

If using default cycles the savings are as follows:

Application	ΔkW per Dryer
Multi-family Dryers	0.0320
On-Premise Laundromats	0.1109

FOSSIL FUEL SAVINGS

Natural gas savings are per retrofitted dryer.

$$\Delta \text{Therms} = N_{\text{Cycles}} * SF$$

Where:

SF = Savings factor
 = 0.15 therms/cycle¹⁸²³

If using default cycles the savings are as follows:

Application	ΔTherms per Dryer
Multi-family Dryers	161
On-Premise Laundromats	541

WATER AND OTHER NON-ENERGY IMPACT DESCRIPTIONS AND CALCULATION

N/A

DEEMED O&M COST ADJUSTMENT CALCULATION

N/A

¹⁸²¹ Estimate based on 45 minutes per cycle.

¹⁸²² In the absence of loadshape information for commercial applications, this is estimated by adjusting the residential coincidence factor proportionately by the relative number of loads (264 for residential and as described in this measure for commercial applications).

¹⁸²³ Savings factor based on engineering analysis of savings data from “Nicor Gas Emerging Technology Program, 1069: Moisture Sensor Retrofit, Comprehensive Pilot Assessment Report,” May 1, 2017 and “Advanced Commercial Clothes Dryer Technologies Field Test,” prepared by Gas Technology Institute for the Minnesota Department of Commerce, January 15, 2018.

MEASURE CODE: CI-MSC-CDMS-V02-230101

REVIEW DEADLINE: 1/1/2027

4.9.10 Efficient Thermal Oxidizers

DESCRIPTION

Thermal oxidizers are used to destroy volatile organic compounds (VOCs) from process exhausts, before emitting the treated air to the environment. VOC emissions are precursors to the formation of ground-level ozone pollution, and its control is mandated by the U.S. EPA. Some VOC constituents are individually toxic and require efficient destruction. Some waste streams have high enough concentrations to present an explosion hazard. Other waste streams merely present nuisance odors that need to be mitigated.

A facility may be required to utilize a thermal oxidizer by a state regulatory agency air quality permit. Some permits may require a VOC destruction efficiency that must be demonstrated with periodic emissions testing. Other permits merely require maintaining an oxidizer chamber temperature. A facility may also choose to utilize a thermal oxidizer for other purposes (nuisance odors) without a regulatory requirement.

The Efficient Thermal Oxidizer measure seeks to evaluate fossil fuel savings from utilizing more efficient means for VOC destruction with the use of a recuperative or regenerative thermal oxidizer. The heat recovery (either recuperative or regenerative) is used to pre-heat the inlet process air stream. This primary heat recovery is used within the thermal oxidizer process and the only heat recovery that is covered in this measure protocol. Fossil fuel savings will result from reduced burner firing. There is a “secondary” form of heat recovery that recovers heat from the combustion exhaust stack for other purposes like space heating, DHW heating, etc.

DEFINITION OF EFFICIENT EQUIPMENT

Two thermal oxidizer technologies can be considered as efficient equipment: recuperative and regenerative.

Recuperative Thermal Oxidizer

In a recuperative thermal oxidizer, the exhaust air stream is sent through a heat exchanger to indirectly pre-heat the inlet air stream coming from the process. The heat exchanger efficiency for a recuperator is typically 50-70%.¹⁸²⁴ The chamber temperature is typically 1,400°F to 1,500°F.

Regenerative Thermal Oxidizer

A regenerative thermal oxidizer utilizes a two-chamber ceramic bed as its heat exchanger system. The exhaust air passes through one bed, imparting its heat onto the ceramic media, while the intake air passes through the other bed, capturing the waste heat from the previous cycle. The flow reverses every few minutes so that the intake bed becomes the exhausted bed and vice versa. The heat exchanger efficiency of a regenerative system is much higher than a recuperative system. These efficiencies can reach 85% to 97%.¹⁸²⁵ However, the ceramic media needs to be periodically cleaned or replaced. The chamber temperatures in regenerative thermal oxidizers are typically 1,500°F to 1,600°F (depending on VOC requirements).

DEFINITION OF BASELINE EQUIPMENT

Depending on the facility process, there may be two baseline selection options: incinerator or recuperator.

The baseline thermal oxidizer with no heat recovery is referred to as an incinerator. This baseline is recommended for selection if it currently exists on site or in new construction when there is a specific process that cannot practically utilize a recuperator due to VOCs coating or clogging the heat exchanger. This system employs a burner to provide direct fire to a process exhaust air stream. Typical operative temperatures are 1,400°F to 2,200°F. The advantage of an afterburner is a quick startup and shutdown time that is ready on demand. The equipment cost is lower than the efficient equipment, but the fuel consumption is much higher.

In all other cases (existing equipment is recuperative or new construction/ expansion of manufacturing process), a recuperative thermal oxidizer is recommended as the appropriate baseline.

¹⁸²⁴ Presentation on the “Operating Cost Reduction Strategies for Oxidizers”, presented by Rich Grzanka, during the Chem Show Technology Exposition on October 31, 2007.

¹⁸²⁵ Ibid.

DEEMED LIFETIME OF EFFICIENT EQUIPMENT

The expected useful life of any thermal oxidizer system is assumed to 20 years.¹⁸²⁶

DEEMED MEASURE COST

The cost of any thermal oxidizer is dependent on various variables such as air flow capacity, destruction efficiency, heat exchanger efficiency, etc.¹⁸²⁷ Shown below is an example of a system for 20,000 cfm.

Recuperative thermal oxidizer costs, based on their heat recovery efficiency, are detailed in the table below.

Heat Recovery Efficiency	Equipment Cost
0%	\$106,042
35%	\$174,193
50%	\$203,801
70%	\$253,801
Average	\$184,317

A regenerative thermal oxidizer at 95% heat recovery has a deemed cost of \$546,000.

Incinerator cost is treated as 0% heat recovery in the recuperative cost summary table above and has a deemed cost of \$106,042.

LOADSHAPE

N/A

COINCIDENCE FACTOR

N/A

Algorithm

CALCULATION OF ENERGY SAVINGS

Energy savings from thermally efficient equipment are entirely fossil fuel related. There are no electricity savings nor peak demand savings, as the blower fans and valve actuators are assumed to operate the same in all conditions.

ELECTRIC ENERGY SAVINGS

N/A

SUMMER COINCIDENT PEAK DEMAND SAVINGS

N/A

FOSSIL FUEL SAVINGS

$$\Delta\text{Therms} = ((\text{Baseline QT Air Pollution Control Device} - \text{Proposed QT Air Pollution Control Device}) \times \text{Hours}) / \text{LHV}$$

Where:

- LHV = Latent Heat of Vaporization
- = If the post is regenerative thermal oxidizer, LHV = 0.953.
- = If the post is recuperative thermal oxidizer, LHV = 1.

¹⁸²⁶ EPA Air Pollution Control Cost Manual, Chapter 2, November 2017. The system capital recovery cost is based on an estimated 20-year equipment life. This estimate of oxidizer equipment life is consistent with information available to EPA and is consistent with statements from large vendors for incinerators and oxidizers.

¹⁸²⁷ U.S. Environmental Protection Agency, Incinerators and Oxidizers, Chapter 2, November 2017.

Regenerative or Recuperative: A baseline or proposed regenerative or recuperative air pollution control device can each be modeled in the following heat balance equation:¹⁸²⁸

$$Q_T \text{ (btuh)} = Q_I + Q_{CC} + Q_{RL} - Q_{VOC}$$

Incinerator: A baseline incinerator air pollution control device can be modeled as the following heat balance equation:

$$Q_T \text{ (btuh)} = Q_I + Q_{CC} + Q_{RL}$$

Where:

- Q_T = Total Energy Input
- Q_I = Energy (btuh) used to raise the temperature of process air (F_I)
- Q_{CC} = Heat (btuh) used to raise the temperature of combustion air (F_{CC})
- Q_{RL} = Radiation heat loss (btuh) from RTO
- Q_{VOC} = Heat release (btuh) provided by VOC combustion
- Hours = Annual hours per year that oxidizer is used

Where:

- $Q_I = F_I * 1.08 * (T_O - T_I)$
- T_O = Average stack outlet temperature (°F) (actual trended average or use efficiency equation below to solve for T_O under assumed conditions)
- $T_O = T_C - (N * (T_C - T_I) * F_I / (F_I + F_{CC}))$
- T_C = Combustion chamber temperature (°F), trended or design value provided by the manufacturer
- N = Thermal Efficiency of Heat Exchanger

Thermal Oxidizer	Efficiency
Regenerative	97%
Recuperative	70%
Incinerator	0%

- T_I = Inlet air temperature (°F), this is the temperature of the air coming from the process
- F_I = Process air flow (cfm), actual loading or use maximum design value
- 1.08 = Conversion Factor
= $60 \text{ (min/hr)} * 0.07489 \text{ (lb/ft}^3\text{, density air at standard conditions)} * 0.2404 \text{ btu/}^\circ\text{F-lb}$, (specific heat of air), where 0.2404 is average heat capacity of intake air

Where:

- $Q_{CC} = F_{CC} * 1.08 * (T_O - T_A)$
- F_{CC} = Additional combustion air flow (cfm) at provided F_I value
= If unknown, assume 3% of design value¹⁸²⁹
- T_O = Average outlet temperature (°F) (same as above)
- T_A = Combustion intake air temperature (°F)

¹⁸²⁸ ICAC Guidance Method for Estimation of Gas Consumption in a Regenerative Thermal Oxidizer (RTO), July 2002.

¹⁸²⁹ Ibid.

= Indoor: Actual, or assume 70 °F year-round

= Outdoor: Actual annual average found near the facility, or assume TMY3 annual averages:

Region / Area	Average Outdoor Air Temperature (°F)
Chicago O'Hare	50.0
Chicago Midway	52.5
Rockford Airport	47.6

Where:

$$Q_{RL} = SA * HLF$$

SA = Surface Area (ft²) (provided by the manufacturer or rough measurements taken)

HLF = Assume a heat loss factor of 240 btuh/ft² if installed outdoors; otherwise, 0 btuh/ft² for indoor installation since the waste heat provides space heating and offset gas-fired space heating equipment

Where:

$$Q_{VOC} = VOC * HC * (\%Dest / 100)$$

VOC = Average lbs/hr from process to oxidizer

HC = btu/lb, weighted average for the heat of combustion of VOCS
= Site-specific, lookup table

%Dest = Destruction efficiency of VOCs provided by the manufacturer, or use:

Hours = Annual hours of operation of the air pollution control device, assume customer production schedule or hours of occupancy

LHV = Lower heating value of natural gas
= 983 btu/CF¹⁸³⁰

HHV = High heating value of natural gas
= 1,031 btu/CF¹⁸³¹

0.953 = LHV / HHV conversion factor

To calculate the fossil fuel savings by upgrading from an incinerator to an efficient thermal oxidizer system, the new temperatures must be considered. The addition of heat recovery (either recuperative or regenerative) will increase the inlet temperature, T_i, above that found in the facility.

The calculation should consider changes in the inlet temperature. First, the key temperature required for 99.99% destruction efficiency of various VOC compounds must be determined. The U.S. EPA's Innovative Strategies and Economics Group produced some guidance on the key temperatures¹⁸³² for the following compounds:

VOC Compound	Key Destruction Temperature (°F)
Acrylonitrile	1,344
Allyl chloride	1,276
Benzene	1,350

¹⁸³⁰ Biomass Energy Data Book, 2011, Appendix A: Lower and Higher Heating Values of Gas, Liquid, and Solid Fuels.

¹⁸³¹ Heat content of natural gas delivered to consumers per the Energy Information Administration, Independent Statistics & Analysis, 2018.

¹⁸³² U.S. Environmental Protection Agency, Incinerators and Oxidizers, Chapter 2, November 2017.

Chlorobenzene	1,407
1,2 – dichloromethane	1,368
Methyl chloride	1,596
Toluene	1,341
Vinyl chloride	1,369

For VOC compounds not listed above, the Key Destruction Temperature should be determined through product literature, equipment vendors, Material Data Safety Sheets (MSDS), or some other source.

When employing heat recovery, either recuperative or regenerative, the increased outlet temperature is limited to the heat exchanger efficiency. This efficiency, or in other words how much heat can be recovered, is limited to the auto-ignition temperatures of the VOCs in the air stream. Regenerative thermal oxidizers offer the advantage of recovering more heat as the combustion can occur within the heat exchanger, whereas with recuperative thermal oxidizers, the heat exchanger efficiency is much lower to prevent premature combustion in the stack of the recuperator.

While the VOCs in the waste air stream have some heating value that contributes to reaching the required chamber temperature, such contributions do not have as high of an impact in the overall energy consumption calculation when compared to the heat exchanger efficiency.

WATER AND OTHER NON-ENERGY IMPACT DESCRIPTIONS AND CALCULATION

Thermal oxidizer operations will have no impact on water or other resources. There may be some safety issues with potential burning hazards from deploying this equipment at high temperatures. There may also be some potential issues with installing outdoor natural gas piping to the location of the thermal oxidizers. In terms of physical sizing, regenerative thermal oxidizers are much larger, thus requiring larger physical space at the site of installation.

DEEMED O&M COST ADJUSTMENT CALCULATION

The ceramic media in the regenerative thermal oxidizer requires regular servicing and may need to be considered as a regular part of facility O&M.

MEASURE CODE: CI-MSC-ETOX-V02-230101

REVIEW DEADLINE: 1/1/2027

4.9.11 Variable Speed Drives for Process Fans

DESCRIPTION

This measure is applied to variable speed drives (VSD) which are installed on non-HVAC fans for process loads. There are separate measures for HVAC pumps and cooling tower fans (4.4.17) and HVAC supply and return fans (4.4.26). VSD process pump applications require custom analysis by the program administrator. The VSD will modulate the speed of the motor when it does not need to run at full load. Since the power of the motor is proportional to the cube of the speed for these types of applications, significant energy savings will result.

This measure was developed to be applicable to the following program types: TOS, RF. If applied to other program types, the measure savings should be verified.

DEFINITION OF EFFICIENT EQUIPMENT

The VSD is applied to a motor which does not have a VSD. The application must have a variable load and installation is to include the necessary controls. Savings are based on application of VSDs to a range of baseline load conditions including no control, inlet guide vanes, outlet guide vanes and throttling valves.

DEFINITION OF BASELINE EQUIPMENT

The time of sale baseline is a new motor installed without a VSD or other methods of control. Retrofit baseline is an existing motor operating without a method of variable control. This information shall be collected from the customer.

Installations of new equipment with VSDs which are required by IECC, the energy code as adopted by the State of Illinois are not eligible for incentives.

Note, IECC 2021 became effective statewide as of 1/1/2024. IECC 2018 is the requisite code for any projects with permitting dates spanning July 1, 2019 to 12/31/2023. Prior to July 1, 2019, IECC 2015 is the applicable code. As code requirements and adoption can differ from municipality to municipality, the user should verify which version of code is applicable given these constraints.

DEEMED LIFETIME OF EFFICIENT EQUIPMENT

The expected measure life is 15 years.¹⁸³³

DEEMED MEASURE COST

The costs vary based on the motor horsepower and application. Actual costs should be used. For default cost estimates, please see table below.¹⁸³⁴

HP	Cost
5 HP	\$2,147
10 HP	\$2,494
15 HP	\$3,940
20 HP	\$4,389
25 HP	\$4,839
30 HP	\$5,289
40 HP	\$6,188
50 HP	\$7,088
60 HP	\$8,463
75 HP	\$9,552

¹⁸³³ ComEd Effective Useful Life Research Report (2018), Navigant, May 14, 2018

¹⁸³⁴ Default incremental costs are sourced from NEEP Incremental Cost Study (ICS) – Phase II Final Report, Navigant, 2013. The VFD costs from the NEEP ICS was further manipulated in 2017 by iTron to account for inflation, other jurisdictions, and other horsepower and application considerations. The default incremental costs assume an average between VFDs with and without bypasses and adjusted to 2023 values to account for inflation.

HP	Cost
100 HP	\$11,365

LOADSHAPE

Time-based schedule considerations are required to perform energy savings calculations and should be concurrently used to establish the savings loadshape that is in alignment with relevant loadshape components and definitions.

COINCIDENCE FACTOR

The demand savings factor (DSF) is already based upon coincident savings, and thus there is no additional coincidence factor for this characterization.

Algorithm

CALCULATION OF SAVINGS

ELECTRIC ENERGY SAVINGS

$$kWh_{Base} = \left(0.746 \times HP \times \frac{LF}{\eta_{motor}} \right) \times RHRS \times \sum_{0\%}^{100\%} (\%FF \times PLR_{Base})$$

$$kWh_{Retrofit} = \left(0.746 \times HP \times \frac{LF}{\eta_{motor}} \right) \times RHRS \times \sum_{0\%}^{100\%} (\%FF \times PLR_{Retrofit})$$

$$ESF = (kWh_{Base} - kWh_{Retrofit}) / kWh_{Base}$$

$$\Delta kWh_{total} = kWh_{Base} \times ESF$$

Where:

kWh_{Base} = Baseline annual energy consumption (kWh/yr)

$kWh_{Retrofit}$ = Retrofit annual energy consumption (kWh/yr)

ESF = Energy savings factor; If ESF is greater than 67%, cap the ESF at 67% for process fan VSD improvements.¹⁸³⁵

ΔkWh_{total} = Total project annual energy savings

0.746 = Conversion factor for HP to kWh

HP = Nominal horsepower of controlled motor

LF = Load Factor; Motor Load at Fan Design CFM (Default = 65%)¹⁸³⁶

η_{motor} = Installed nominal/nameplate motor efficiency

= Default motor is a NEMA Premium Efficiency, ODP, 4-pole/1800 RPM fan motor

NEMA Premium Efficiency Motors Default Efficiencies¹⁸³⁷

¹⁸³⁵ Recommendations for Verifying Savings for non-HVAC VFDs memorandum calculated an energy savings limit of 67% for process fans using the Toshiba Energy Savings Software for Motors and Drives (2009 version).

¹⁸³⁶ Lawrence Berkeley National Laboratory, and Resource Dynamics Corporation. (2008). "Improving Motor and Drive System Performance; A Sourcebook for Industry". U.S. Department of Energy, Office of Energy Efficiency and Renewable Energy. Golden, CO: National Renewable Energy Laboratory.

¹⁸³⁷ Douglass, J. (2005). Induction Motor Efficiency Standards. Washington State University and the Northwest Energy Efficiency Alliance, Extension Energy Program, Olympia, WA, October 2005.

Size HP	Open Drip Proof (ODP)			Totally Enclosed Fan-Cooled (TEFC)		
	# of Poles			# of Poles		
	6	4	2	6	4	2
	Speed (RPM)			Speed (RPM)		
	1200	1800 Default	3600	1200	1800	3600
1	0.825	0.855	0.770	0.825	0.855	0.770
1.5	0.865	0.865	0.840	0.875	0.865	0.840
2	0.875	0.865	0.855	0.885	0.865	0.855
3	0.885	0.895	0.855	0.895	0.895	0.865
5	0.895	0.895	0.865	0.895	0.895	0.885
7.5	0.902	0.910	0.885	0.910	0.917	0.895
10	0.917	0.917	0.895	0.910	0.917	0.902
15	0.917	0.930	0.902	0.917	0.924	0.910
20	0.924	0.930	0.910	0.917	0.930	0.910
25	0.930	0.936	0.917	0.930	0.936	0.917
30	0.936	0.941	0.917	0.930	0.936	0.917
40	0.941	0.941	0.924	0.941	0.941	0.924
50	0.941	0.945	0.930	0.941	0.945	0.930
60	0.945	0.950	0.936	0.945	0.950	0.936
75	0.945	0.950	0.936	0.945	0.954	0.936
100	0.950	0.954	0.936	0.950	0.954	0.941
125	0.950	0.954	0.941	0.950	0.954	0.950
150	0.954	0.958	0.941	0.958	0.958	0.950
200	0.954	0.958	0.950	0.958	0.962	0.954
250	0.954	0.958	0.950	0.958	0.962	0.958
300	0.954	0.958	0.954	0.958	0.962	0.958
350	0.954	0.958	0.954	0.958	0.962	0.958
400	0.958	0.958	0.958	0.958	0.962	0.958
450	0.962	0.962	0.958	0.958	0.962	0.958
500	0.962	0.962	0.958	0.958	0.962	0.958

RHRS = Annual operating hours of process fan. Actual hours should be used.

%FF = Percentage of run-time spent within a given flow fraction range.

Fans used in process applications operate under site-specific conditions. The percentage of run-time spent within each of the given ranges in the table below should be field collected.

Flow Fraction (% of design cfm)	Percent of Time at Flow Fraction
0% to 10%	
>10% to 20%	
>20% to 30%	
>30% to 40%	
>40% to 50%	
>50% to 60%	
>60% to 70%	
>70% to 80%	

Field Collected for each bin.

Flow Fraction (% of design cfm)	Percent of Time at Flow Fraction
>80% to 90%	
>90% to 100%	

PLR_{Base} = Part load ratio for a given flow fraction range based on the baseline flow control type

$PLR_{Retrofit}$ = Part load ratio for a given flow fraction range based on the retrofit flow control type

Control Type	Flow Fraction									
	0-10%	>10% to 20%	>20% to 30%	>30% to 40%	>40% to 50%	>50% to 60%	>60% to 70%	>70% to 80%	>80% to 90%	>90% to 100%
No Control or Bypass Damper	1.00	1.00	1.00	1.00	1.00	1.00	1.00	1.00	1.00	1.00
Discharge Dampers	0.46	0.55	0.63	0.70	0.77	0.83	0.88	0.93	0.97	1.00
Outlet Damper, BI & Airfoil Fans	0.53	0.53	0.57	0.64	0.72	0.80	0.89	0.96	1.02	1.05
Inlet Damper Box	0.56	0.60	0.62	0.64	0.66	0.69	0.74	0.81	0.92	1.07
Inlet Guide Vane, BI & Airfoil Fans	0.53	0.56	0.57	0.59	0.60	0.62	0.67	0.74	0.85	1.00
Inlet Vane Dampers	0.38	0.40	0.42	0.44	0.48	0.53	0.60	0.70	0.83	0.99
Outlet Damper, FC Fans	0.22	0.26	0.30	0.37	0.45	0.54	0.65	0.77	0.91	1.06
Eddy Current Drives	0.17	0.20	0.25	0.32	0.41	0.51	0.63	0.76	0.90	1.04
Inlet Guide Vane, FC Fans	0.21	0.22	0.23	0.26	0.31	0.39	0.49	0.63	0.81	1.04
VFD with duct static pressure controls	0.09	0.10	0.11	0.15	0.20	0.29	0.41	0.57	0.76	1.01
VFD with low/no duct static pressure	0.05	0.06	0.09	0.12	0.18	0.27	0.39	0.55	0.75	1.00

$\sum_{0\%}^{100\%}(\%FF \times PLR)$ = The sum of the product of the percentage of run-time spent within a given flow fraction range (%FF) and the part load ratio for a given flow fraction range based on the retrofit flow control type.

Example: A process fan with discharge damper controls operates 85% of the time at 75% flow fraction, 5% of the time at 80% flow fraction, and 10% of the time at 95% flow fraction:

$$\sum_{0\%}^{100\%}(\%FF \times PLR) = (0.85 \times 0.93) + (0.05 \times 0.97) + (0.10 \times 1.00) = 0.939\%$$

SUMMER COINCIDENT PEAK DEMAND SAVINGS

$$kW_{Base} = \left(0.746 \times HP \times \frac{LF}{\eta_{motor}}\right) \times PLR_{Base,FFpeak}$$

$$kW_{Retrofit} = \left(0.746 \times HP \times \frac{LF}{\eta_{motor}}\right) \times PLR_{Retrofit,FFpeak}$$

$$\Delta kW_{fan} = kW_{Base} - kW_{Retrofit}$$

Where:

kW_{Base} = Baseline summer coincident peak demand (kW)

$kW_{Retrofit}$	= Retrofit summer coincident peak demand (kW)
ΔkW_{fan}	= Fan-only summer coincident peak demand impact
ΔkW_{total}	= Total project summer coincident peak demand impact
$PLR_{Base,FFpeak}$	= The part load ratio for the average flow fraction between the peak daytime hours during the weekday peak time period based on the baseline flow control type (default average flow fraction during peak period = 90%)
$PLR_{Retrofit,FFpeak}$	= The part load ratio for the average flow fraction between the peak daytime hours during the weekday peak time period based on the retrofit flow control type (default average flow fraction during peak period = 90%)

FOSSIL FUEL IMPACT DESCRIPTIONS AND CALCULATION

There are no expected fossil fuel impacts for this measure.

WATER IMPACT DESCRIPTIONS AND CALCULATION

N/A

DEEMED O&M COST ADJUSTMENT CALCULATION

N/A

MEASURE CODE: CI-MSC-VSDP-V04-250101

REVIEW DEADLINE: 1/1/2028

4.9.12 Low Flow Toilets and Urinals

DESCRIPTION

Toilets and urinals are found in bathrooms located in commercial, and industrial facilities. The first federal standards dealing with water consumption for toilets and urinals was the Energy Policy Act of 1992. It specified a gallon per flush (gpf) standard for both fixtures. These standards are used to define the baseline equipment for this measure. The Subsequent U.S. EPA WaterSense program in 2009 set even tighter standards for plumbing fixtures, including toilets and urinals. These standards are used to define the efficient equipment for this measure.

DEFINITION OF EFFICIENT EQUIPMENT

The high efficiency equipment is either a U.S. EPA WaterSense certified commercial toilet fixture or commercial urinal.

DEFINITION OF BASELINE EQUIPMENT

The baseline equipment is a toilet or urinal that has a maximum gallons per flush outlined by the Energy Policy Act of 1992.

DEEMED LIFETIME OF EFFICIENT EQUIPMENT

The estimated useful life for this measure is assumed to be 25 years for both toilets and urinals.¹⁸³⁸

DEEMED MEASURE COST

The incremental costs for both toilets and urinals are \$0.¹⁸³⁹

LOADSHAPE

Loadshape C02 - Commercial Electric DHW

COINCIDENCE FACTOR

N/A

Algorithm

CALCULATION OF ENERGY SAVINGS

ELECTRIC ENERGY SAVINGS

The following savings should be included in the total savings for this measure but should not be included in TRC tests to avoid double counting the economic benefit of water savings.

$$\begin{aligned} \Delta \text{kWh} &= \Delta \text{Water} / 1,000,000 * E_{\text{water total}} \\ E_{\text{water}} &= \text{IL Total Water Energy Factor (kWh/Million Gallons)} \\ &= 5,010^{1840} \end{aligned}$$

¹⁸³⁸ ATD Home Inspection: <http://www.atdhomeinspection.com/advice/average-product-life/> is 50 years. 25 years is used to be conservative.

¹⁸³⁹ Measure cost assumption from City of Fort Collins, "Green Building Practice Summary," March 21, 2011, page 2. The document states "Information from the EPA WaterSense web site: WaterSense® labeled toilets are not more expensive than regular toilets. MaP testing results have shown no correlation between price and performance. Prices for toilets can range from less than \$100 to more than \$1,000. Much of the variability in price is due to style, not functional design."

¹⁸⁴⁰ This factor includes 2571 kWh/MG for water supply based on Illinois energy intensity data from a 2012 ISAWWA study and 2439 kWh/MG for wastewater treatment based on national energy intensity use estimates. For more information, please review Elevate Energy's Review 'IL TRM: Energy per Gallon Factor, May 2018'.

Toilet Calculation:

For example, a low flow toilet is installed in a commercial location.

$$\begin{aligned} \Delta kWh &= 491 \text{ gal/year} / 1,000,000 * 5,010 \text{ kWh/million gallons} \\ &= 2.5 \text{ kWh/year} \end{aligned}$$

Urinal Calculation:

For example, a low flow urinal is installed in a commercial location.

$$\begin{aligned} \Delta kWh &= 2,340 \text{ gal/year} / 1,000,000 * 5,010 \text{ kWh/million gallons} \\ &= 11.7 \text{ kWh/year} \end{aligned}$$

SUMMER COINCIDENT PEAK DEMAND SAVINGS

N/A

FOSSIL FUEL SAVINGS

N/A

WATER IMPACT DESCRIPTIONS AND CALCULATION

$$\Delta \text{Water} = (\text{GPF}_{\text{Base}} - \text{GPF}_{\text{Eff}}) * \text{NFPD} * \text{ADPY}$$

Where:

- GPF_{Base} = Baseline equipment gallons per flush
 = 1.6 for toilets¹⁸⁴¹
 = 1.0 for urinals¹⁸⁴²
- GPF_{Eff} = Efficient equipment gallons per flush
 = Actual, if unknown assume 1.28 for toilets¹⁸⁴³
 = Actual, if unknown assume 0.5 for urinals¹⁸⁴⁴
- NFPD = Number of flushes per day
 = 5.9 for toilets¹⁸⁴⁵
 = 18 for urinals^{1846,1847}
- ADPY = Annual days per year
 = 260 for commercial and industrial¹⁸⁴⁸

¹⁸⁴¹ U. S. EPA WaterSense. “Water Efficiency Management Guide – Bathroom Suite” (EPA 832-F-17-016d), Nov 2017.

¹⁸⁴² U.S. EPA WaterSense. “WaterSenses Specification for Flushing Urinals Supporting Statement”, Oct 2009.

¹⁸⁴³ U. S. EPA WaterSense. “Water Efficiency Management Guide – Bathroom Suite” (EPA 832-F-17-016d), Nov 2017.

¹⁸⁴⁴ U.S. EPA WaterSense. “WaterSenses Specification for Flushing Urinals Supporting Statement”, Oct 2009.

¹⁸⁴⁵ CASE Initiative for PY 2013: Analysis of Standards Proposal for Toilets and Urinals Water Efficiency. July 29, 2013. Pg 18.

¹⁸⁴⁶ Ibid.

¹⁸⁴⁷ U.S. EPA WaterSense. “WaterSenses Specification for Flushing Urinals Supporting Statement”, Oct 2009. Pg 1.

¹⁸⁴⁸ Assuming the work week is Monday through Friday.

Toilet Calculation:

For example, a low flow toilet is installed in a commercial location.

$$\begin{aligned}\Delta\text{Water} &= [(1.6 - 1.28) \text{ gal/flush} \times 5.9 \text{ flush/day} \times 260 \text{ days/year}] \\ &= 491 \text{ gal/year}\end{aligned}$$

Urinal Calculation:

For example, a low flow urinal is installed in a commercial location.

$$\begin{aligned}\Delta\text{Water} &= (1.0 - 0.5) \text{ gal/flush} \times 18 \text{ flush/day} \times 260 \text{ days/year} \\ &= 2,340 \text{ gal/year}\end{aligned}$$

DEEMED O&M COST ADJUSTMENT CALCULATION

N/A

MEASURE CODE: CI-MSC-LFTU-V02-210101

REVIEW DEADLINE: 1/1/2023

4.9.13 Smart Irrigation Controls

DESCRIPTION

Irrigation systems are commonly found on commercial properties, educational institutions, public parks, golf courses, and other facilities with landscaped grounds. They are typically operated on timers, applying the irrigation water in the early morning or after dusk. The timing and duration of irrigation application are determined by the user, along with the location and density of sprinklers. The irrigation water gets applied according to the control schedule, regardless of whether the landscape actually needs the irrigation water at that time.

The new measure involves the installation of a control system technology that reduces or eliminates irrigation during times of precipitation or when there is already sufficient soil moisture. This measure applies to landscape irrigation systems for commercial, institutional, and public properties only. It does not apply to agricultural irrigation systems for crops or residential landscape irrigation systems.

This measure was developed to be applicable to the following program types: TOS, RF. If applied to other program types, the measure savings should be verified.

DEFINITION OF EFFICIENT EQUIPMENT

Smart Irrigation Controls utilize sensors, gauges, or local weather forecasts to regulate the application of irrigation water to lawn or landscape vegetation. There are two main technologies used for this purpose: 1) Precipitation based smart irrigation controllers, and 2) Soil-moisture based smart irrigation controllers.

Precipitation Based Smart Irrigation Controllers

This type of system utilizes either an on-site rain gauge or a local weather service to determine if there is sufficient precipitation to allow shut-off of the irrigation water.

Soil Moisture Based Smart Irrigation Controllers

This type of system utilizes soil moisture sensors, buried in the root zone, to determine if irrigation water is needed. A “suspended cycle irrigation system” uses the soil moisture sensors to determine whether a regularly scheduled irrigation application is necessary. If there is sufficient soil moisture, then the next scheduled irrigation cycle gets interrupted. A “water-on-demand irrigation system” applies irrigation water when the moisture sensor reaches its lower limit and shuts off when the moisture sensor reaches its upper limit. There is no regularly scheduled irrigation with the water on demand system.

For the purposes of this measure characterization, the assumed rolling 24-hour threshold for shutting off the irrigation is 6 mm (0.24”). The Savings Factor is based on the percentage of time that the rolling 24-hour average of precipitation meets or exceed the 6 mm threshold.

DEFINITION OF BASELINE EQUIPMENT

The baseline irrigation system applies irrigation water to the lawn or landscape on a regularly scheduled timer. The timing and duration of irrigation application are determined by the user, along with the location and density of sprinklers. The irrigation water gets applied according to the control schedule, regardless of whether the landscape actually needs the irrigation water at that time.

Sprinkler head nozzles have a variety of configurations that affect the distribution of the irrigation water. The water can come in the form of a spray, a rotating plume, a bubbler, or a drip.

Typical baseline irrigation systems provide 1 inch of irrigation to the entire lawn. This is equivalent to 0.623 gallons per square foot of lawn per week.¹⁸⁴⁹

DEEMED LIFETIME OF EFFICIENT EQUIPMENT

The expected useful life for Irrigation Control Measures is assumed to be 15 years.

¹⁸⁴⁹ Today’s Homeowner with Danny Lipford. “How to Calculate Lawn Irrigation Water Usage and Costs.”

DEEMED MEASURE COST

The measure cost for a multi-zone smart irrigation control system is \$500.¹⁸⁵⁰

LOADSHAPE

N/A

COINCIDENCE FACTOR

N/A

Algorithm

CALCULATION OF ENERGY SAVINGS

Energy savings from Irrigation Control Measures are the result of reduced water consumption. There are indirect electric energy savings from reduced potable water treatment.

ELECTRIC ENERGY SAVINGS

The electric energy savings are based indirectly on the reduced electricity usage used to provide the potable water and treat the wastewater. By applying an “Energy Factor”, the water savings (in gallons/year) can be converted to electricity savings (in kWh/year). This “Energy Factor” considers the electric energy requirements of potable water treatment plants and potable water distribution. Since the “wasted” irrigation water in the baseline case will likely be absorbed into the soil or will runoff into surface water bodies, electricity savings from a reduction in wastewater treatment load would not apply.

The methodology for quantifying the water savings involves a direct comparison of the baseline equipment to the efficient equipment. In order to calculate the baseline water usage of an irrigation system, the number of sprinklers and their sizing need to be determined. The static pressure and sizing of the water service, along with the sprinkler head orifice sizing will ultimately determine the flow rate of water.

The electricity savings for this measure can be calculated by applying an energy factor to the calculated water savings.

$$\Delta kWh_{water} = \Delta Water / 1,000,000 * E_{water}$$

Where:

$$E_{water} = \text{Illinois Total Water Energy Factor (kWh/Million Gallons)} \\ = 2,571^{1851}$$

The total water savings for this measure can be calculated as follows:

$$\Delta Water = BSFL - ESFL$$

Where:

$$\Delta Water = \text{Total Water Savings (gallon/season)}$$

The baseline volumetric flow rate for the entire system can be calculated as follows:

$$BSFL = NOS \times SFL \times DOI \times NAY$$

¹⁸⁵⁰ Material pricing taken from Google shopping search on “smart irrigation control system”. The Rain Bird Smart LNK WiFi Irrigation System Indoor Controller (4 Pack) sells for \$316 from online retailer Wish.com. Installation labor pricing taken from online retailer Home Advisor – Lawn and Garden, Repair a Sprinkler System **Error! Hyperlink reference not valid.** which stated \$45 to \$200 per hour for a plumber.

¹⁸⁵¹ This factor include 2571 kWh/MG for water supply based on Illinois energy intensity data from a 2012 ISAWWA study and 2439 kWh/MG for wastewater treatment based on national energy intensity use estimates. For more information please review Elevate Energy’s ‘IL TRM: Energy per Gallon Factor, May 2018 paper’.

Where:

BSFL	= Baseline System Flow Rate (gallon/year)
NOS	= Number of Sprinklers, the total number of sprinklers at the property = Actual
SFL	= Sprinkler Flow Rate (gallon/minute) = Actual, site-specific irrigation system specifications should be consulted to determine the property’s sprinkler flow rate
DOI	= Duration of Irrigation (minutes/application) = Actual, the baseline scheduling controls should be used to determine the irrigation season
NAY	= Number of Applications per Year (application/year) = Actual

The efficient volumetric flow rate can be calculated as follows:

$$ESFL = BSFL \times (1 - SF)$$

Where:

ESFL	= Efficient System Flow Rate (gallon/season)
BSFL	= Baseline System Flow Rate (gallon/season)
SF	= Savings Factor

The volumetric flow rate for the entire efficient system is based on applying a Savings Factor (SF) to the BSFL. The SF is determined by calculating the number of weeks in the irrigation season (April 25 through October 13) when there is sufficient precipitation to allow the shutoff of the irrigation system. Typical Meteorological Year (TMY-3) data gives precipitation depth in millimeters for each hour of the typical year. By consulting the TMY-3 data for the closest applicable weather station, the SF can be determined.

One source recommends a rain sensor shut-off threshold of 6 mm of precipitation for twice or thrice weekly irrigation schedule or 13 mm of precipitation for once weekly irrigation schedule.¹⁸⁵² For the purposes of this workpaper, we will use a rolling 24-hour threshold of 6 mm.

The State Climatologist Office for Illinois produced a map of the Illinois Growing Season days per year for different parts of the state.¹⁸⁵³ Using a growing season average of 170 days, the “irrigation season” begins on April 25 and end on October 13.

By analyzing the TMY-3 precipitation data, the number of weeks during the “irrigation season” that the rolling 24-hour precipitation levels greater than 6 mm can be determined, along with the Savings Factors:

Chicago:	SF = 0.265
Midway:	SF = 0.241
Rockford:	SF = 0.268
Peoria:	SF = 0.227
Springfield:	SF = 0.186

¹⁸⁵² Michael D. Dukes. “Smart Irrigation Controllers: What Makes an Irrigation Controller Smart”. University of Florida, Institute for Food & Agricultural Sciences.

¹⁸⁵³ State Climatologist Office for Illinois, Illinois State Water Survey, 2003. Based on 1971 – 2000 data, assessing the number of days between the last spring drop below 32 degrees and the first fall drop below 32 degrees.

For example, an irrigation system in Rockford with 50 sprinklers running at 5 gallons per minute, 20 minutes per sprinkle with 100 sprinkles per year would save:

$$\Delta kWh = \Delta Water / 1,000,000 * E_{water}$$

$$\Delta Water = BSFL - ESFL$$

$$BSFL = NOS * SFL * DOI * NAY$$

$$= 50 * 5 * 20 * 100$$

$$= 500,000$$

$$ESFL = BSFL * (1 - SF)$$

$$= 500,000 * (1 - 0.268)$$

$$= 366,000$$

$$\Delta Water = 500,000 - 366,000$$

$$= 134,000$$

$$\Delta kWh = 134,000 / 1,000,000 * 2571$$

$$= 344.5 kWh$$

SUMMER COINCIDENT PEAK DEMAND SAVINGS

N/A

FOSSIL FUEL SAVINGS

N/A

WATER AND OTHER NON-ENERGY IMPACT DESCRIPTIONS AND CALCULATION

The water savings inherent in the efficient irrigation control technology will help preserve water supplies and extend the life of water treatment and wastewater treatment equipment. By reducing irrigation during periods of precipitation, unnecessary storm runoff and puddling can be avoided. For more details on calculating water savings, please see the ‘Algorithm’ section of this characterization.

DEEMED O&M COST ADJUSTMENT CALCULATION

Maintaining an Efficient Irrigation Control system will require periodic cleaning and calibration of the sensors. Any wiring or wireless communication devices will also need to be maintained. Costs for these activities is \$196.¹⁸⁵⁴

MEASURE CODE: CI-MSC-SIRC-V03-250101

REVIEW DEADLINE: 1/1/2029

¹⁸⁵⁴ Based on data provided on Home Advisor website, Lawn and Garden, Repair a Sprinkler System. **Error! Hyperlink reference not valid.**

4.9.14 Switch Peripheral Equipment Consolidation

DESCRIPTION

This measure will allow for projects with small scopes of equipment replacement to be cost effectively brought into the telecommunication optimization incentive program. Consolidating telecommunication line and trunk equipment eliminate underutilized equipment which reduces power draw from the rectifier. This avoided heat load also results in cooling savings.

This measure was developed to be applicable to the following program types: RF. If applied to other program types, the measure savings should be verified.

DEFINITION OF EFFICIENT EQUIPMENT

The measure requires no new equipment and only consolidates partially loaded equipment. There are a myriad of different types of line and trunk equipment, but consolidation eliminates underutilized equipment which will result in energy savings.

DEFINITION OF BASELINE EQUIPMENT

Baseline telecommunications equipment is partially loaded line and trunk equipment that is no longer needed due to line loss on the telecommunications network. Lines are consolidated to like equipment and the underutilized equipment is removed. This applies to all line and trunk equipment and does not exclude participation from any particular type of line and trunk equipment. All line and trunk equipment are considered eligible but only up to and including 40 pieces of equipment. Above that amount, projects will require on-site amp reduction verification.

Baseline cooling equipment is assumed to be an Air-Cooled Chiller without an economizer with a capacity >240 MBtu. If cooling equipment can be verified, the chiller efficiency can be replaced with the appropriate value using Table below.

ASHRAE 90.1 2016: Table 6.8.1-11

Equipment Type	Net Sensible Cooling Capacity	Downflow units	Upflow - Ducted	Upflow - Unducted	Horizontal Flow
		COP	COP	COP	COP
Air Cooled	< 65 MBtuh	2.30	2.10	2.09	2.45
	> 65 MBtuh and < 240 MBtuh	2.20	2.05	1.99	2.35
	> 240 MBtuh	2.00	1.85	1.79	2.15
Water Cooled	< 65 MBtuh	2.50	2.30	2.25	2.70
	> 65 MBtuh and < 240 MBtuh	2.40	2.20	2.15	2.60
	> 240 MBtuh	2.25	2.10	2.05	2.45
Water Cooled with Fluid Economizer	< 65 MBtuh	2.45	2.25	2.20	2.60
	> 65 MBtuh and < 240 MBtuh	2.35	2.15	2.10	2.55
	> 240 MBtuh	2.20	2.05	2.00	2.40
Glycol Cooled	< 65 MBtuh	2.30	2.10	2.00	2.40
	> 65 MBtuh and < 240 MBtuh	2.05	1.85	1.85	2.15
	> 240 MBtuh	1.95	1.80	1.75	2.10
Glycol Cooled with Fluid Economizer	< 65 MBtuh	2.25	2.10	2.00	2.35
	> 65 MBtuh and < 240 MBtuh	1.95	1.80	1.75	2.10
	> 240 MBtuh	1.90	1.80	1.70	2.10

Converted ASHRAE 90.1 2016: Table 6.8.1-11 Cooling Efficiency Table

Equipment Type	Net Sensible Cooling Capacity	Downflow units	Upflow - Ducted	Upflow - Unducted	Horizontal Flow
		kW/Ton	kW/Ton	kW/Ton	kW/Ton
Air Cooled	< 65 MBtuh	1.53	1.67	1.68	1.44
	> 65 MBtuh and < 240 MBtuh	1.60	1.72	1.77	1.50
	> 240 MBtuh	1.76	1.90*	1.96	1.64
Water Cooled	< 65 MBtuh	1.41	1.53	1.56	1.30
	> 65 MBtuh and < 240 MBtuh	1.47	1.60	1.64	1.35
	> 240 MBtuh	1.56	1.67	1.72	1.44
Water Cooled with Fluid Economizer	< 65 MBtuh	1.44	1.56	1.60	1.35
	> 65 MBtuh and < 240 MBtuh	1.50	1.64	1.67	1.38
	> 240 MBtuh	1.60	1.72	1.76	1.47
Glycol Cooled	< 65 MBtuh	1.53	1.67	1.76	1.47
	> 65 MBtuh and < 240 MBtuh	1.72	1.90	1.90	1.64
	> 240 MBtuh	1.80	1.95	2.01	1.67
Glycol Cooled with Fluid Economizer	< 65 MBtuh	1.56	1.67	1.76	1.50
	> 65 MBtuh and < 240 MBtuh	1.80	1.95	2.01	1.67
	> 240 MBtuh	1.85	1.95	2.07	1.67

*Default value based on previous program data; in all but one project, this was the cooling efficiency value used

DEEMED LIFETIME OF EFFICIENT EQUIPMENT

10 years.¹⁸⁵⁵

DEEMED MEASURE COST

There is no equipment cost to implement this measure. The only associated cost is the required internal labor to move lines from the to-be-removed piece of equipment to the chosen like piece of equipment. The default labor cost is \$742/piece of equipment removed.¹⁸⁵⁶

LOADSHAPE

Loadshape is determined by the constant power draw by the line and trunk equipment; default loadshape is: Loadshape C53 – Flat.

COINCIDENCE FACTOR

Coincidence Factor is determined by the constant power draw by the line and trunk equipment; the summer peak coincidence factor for the line and trunk equipment is assumed to be 100%. The cooling coincident factor is assumed to be consistent with the summer system peak coincidence factor as provided below:

$$CF_{SSP} = \text{Summer System Peak Coincidence Factor for Commercial cooling (during system peak hour)}$$

$$= 91.3\% \text{ }^{1857}$$

Algorithm

CALCULATION OF ENERGY SAVINGS

ELECTRIC ENERGY SAVINGS

$$\text{kWh Savings} = p * kW_{Trunk} * (1 + LCF * CE) * t$$

Where:

- p = Number of pieces of redundant equipment removed
= Actual
- kW_{Trunk} = Average line and trunk equipment power draw
= 0.233 kW¹⁸⁵⁸
- LCF = Load Conversion Factor kW to Ton of cooling (tons/kW)
= 0.284 ¹⁸⁵⁹
- CE = Cooling Efficiency

¹⁸⁵⁵ Assumption is based on communication from AT&T program manager indicating an expectation that consolidated equipment should be expected to remain for a minimum of 10 years.

¹⁸⁵⁶ Value based on the average of program data provided by Franklin Energy. See “Network Combing Workpaper Research_v2.xls” for details. Note projects were capped at 40 pieces of equipment in the development of this average.

¹⁸⁵⁷ Based on analysis of Itron eShape data for Missouri, calibrated to Illinois loads, supplied by Ameren. The AC load during the utility’s peak hour is divided by the maximum AC load during the year.

¹⁸⁵⁸ Value based on the average of program data provided by Franklin Energy. See “Network Combing Workpaper Research_v2.xls” for details. Note projects were capped at 40 pieces of equipment in the development of this average.

¹⁸⁵⁹ 1 ton of cooling = 12,000 BTU/h. 1kWh = 3412 BTU. Therefore 1 ton of cooling = 12000BTU/h * 1 kWh/3412 BTU = 3.51 kW per ton, = 0.284 tons/kW.

t = Actual, if unknown assume 1.90 kW/ton¹⁸⁶⁰
 t = time (hours)
 t = 8,760 hours

SUMMER COINCIDENT PEAK DEMAND SAVINGS

$$\text{kW Savings} = p * \text{kW}_{\text{Trunk}} * (\text{CF}_{\text{Trunk}} + \text{LCF} * \text{CE} * \text{CF}_{\text{SSPCool}})$$

Where:

p = Number of pieces of redundant equipment removed
 kW_{Trunk} = Average line and trunk equipment power draw, 0.233 kW
 LCF = Load Conversion Factor kW to Ton, 0.284
 CE = Cooling Efficiency, default value = 1.90 kW/ton based on previous program data
 CF_{Trunk} = Line and Trunk Equipment Coincidence Factor, 1.0
 $\text{CF}_{\text{SSPCool}}$ = Summer System Peak Coincidence Factor for Commercial cooling (during system peak hour)
 $\text{CF}_{\text{SSPCool}}$ = 91.3%¹⁸⁶¹

FOSSIL FUEL SAVINGS

N/A

WATER AND OTHER NON-ENERGY IMPACT DESCRIPTIONS AND CALCULATION

N/A

DEEMED O&M COST ADJUSTMENT CALCULATION

N/A

MEASURE CODE: CI-MSC-SPEC-V02-230101

REVIEW DEADLINE: 1/1/2027

¹⁸⁶⁰ Cooling efficiency kW/ton default is based on air cooled units >240 Mbtuh, upflow ducted value as per the ASHRAE 90.1 2016 tables provided in the baseline section. This was the appropriate cooling efficiency value for all but one of Franklin Energy's projects.

¹⁸⁶¹ Based on analysis of Itron eShape data for Missouri, calibrated to Illinois loads, supplied by Ameren. The AC load during the utility's peak hour is divided by the maximum AC load during the year.

4.9.15 ENERGY STAR Low Wattage Uninterruptible Power Supply

DESCRIPTION

This measure is for replacing an inefficient uninterruptible power supply (UPS) with an efficient ENERGY STAR rated UPS in telecommunications, or similar facility that operates continuously. Note for data centers and other facilities that are not operated similarly to telecommunication applications, a custom calculation based on M&V analysis and that accounts for ramp-up of loads on the UPS should be performed. UPS units provide backup power in data centers and draw power constantly to keep their batteries charged. Uninterruptible power supplies (UPS) are utilized in many organizations to protect themselves from downtime with power distribution and avoid data processing errors due to downtimes. UPS systems are connected between the public power distribution system and mission critical loads.

This measure applies to UPS's with a rated output power less than or equal to 1,875 watts.

This measure was developed to be applicable to the following program types: TOS. If applied to other program types, the measure savings should be verified.

DEFINITION OF EFFICIENT EQUIPMENT

The efficient condition is a new ENERGY STAR UPS in a telecommunication or similar application. For single-normal mode UPSs, the installed system must meet or exceed the average loading-adjusted efficiency values required by the ENERGY STAR program. The new UPS must have a rated output power less than or equal to 1,875 watts, the limit of the scope of the federal UPS standard.¹⁸⁶²

DEFINITION OF BASELINE EQUIPMENT

The baseline condition is an existing non-ENERGY STAR UPS in a telecommunication or similar application.

DEEMED LIFETIME OF EFFICIENT EQUIPMENT

The measure life is assumed to be 15 years.¹⁸⁶³

DEEMED MEASURE COST

The incremental cost is estimated at \$59 per UPS unit.¹⁸⁶⁴

LOADSHAPE

Loadshape is determined by the constant power draw by the UPS; default loadshape is Loadshape C53 – Flat.

COINCIDENCE FACTOR

The coincidence factor for the UPS or rectifier is assumed to be 1.0 due to equipment operating during peak period.

¹⁸⁶² Code of Federal Regulations, Energy Conservation Standards for Uninterruptible Power Supplies, effective January 10, 2022 (10 CFR 430.32(z)(3)).

¹⁸⁶³ California Municipal Utilities Association. Savings Estimation Technical Reference Manual 2017, Third Edition. Section 8.12, p. 8–15.

¹⁸⁶⁴ As estimated in the California Municipal Utilities Association. Savings Estimation Technical Reference Manual 2017, incremental measure cost based on average UPS costs for a range of sizes, assuming a 30% premium for an ENERGY STAR UPS.

Algorithm

CALCULATION OF ENERGY SAVINGS

ELECTRIC ENERGY SAVINGS

$$\Delta \text{kWh} = \text{Size} * (1/\text{Eff}_{\text{AVGbase}} - 1/\text{Eff}_{\text{AVGee}}) * \text{EFLH}$$

Where:

- Size = Size of UPS in rated output power, kW
- Eff_{AVGbase} = Efficiency of existing UPS
= Actual or use table below¹⁸⁶⁵

UPS Product Class	Rated Output Power	Minimum Efficiency
Voltage and Frequency Dependent (VFD)	P ≤ 300 W	$-1.20 \times 10^{-6} \times P^2 + 7.17 \times 10^{-4} \times P + 0.862$
	300 W < P ≤ 700 W	$-7.85 \times 10^{-8} \times P^2 + 1.01 \times 10^{-4} \times P + 0.946$
	P > 700 W	$-7.23 \times 10^{-9} \times P^2 + 7.52 \times 10^{-6} \times P + 0.977$
Voltage Independent (VI)	P ≤ 300 W	$-1.20 \times 10^{-8} \times P^2 + 7.19 \times 10^{-4} \times P + 0.863$
	300 W < P ≤ 700 W	$-7.67 \times 10^{-8} \times P^2 + 1.05 \times 10^{-4} \times P + 0.946$
	P > 700 W	$-4.62 \times 10^{-9} \times P^2 + 8.54 \times 10^{-6} \times P + 0.979$
Voltage and Frequency Independent (VFI)	P ≤ 300 W	$-3.13 \times 10^{-8} \times P^2 + 1.960 \times 10^{-4} \times P + 0.543$
	300 W < P ≤ 700 W	$-2.60 \times 10^{-8} \times P^2 + 3.65 \times 10^{-4} \times P + 0.764$
	P > 700 W	$-1.70 \times 10^{-8} \times P^2 + 3.85 \times 10^{-6} \times P + 0.876$

- Eff_{AVGee} = Efficiency of new ENERGY STAR UPS
= Actual or ENERGY STAR minimum value from table below¹⁸⁶⁶

Rated Output Power	UPS Product Class		
	VFD	VI	VFI
P ≤ 350 W	$5.71 \times 10^{-5} \times P + 0.962$	$5.71 \times 10^{-5} \times P + 0.964$	$0.011 \times \ln(P) + 0.824$
350 W < P ≤ 1.5 kW	0.982	0.984	$0.011 \times \ln(P) + 0.824$
1.5 kW < P ≤ 1.875 kW	0.981 - E _{MOD}	0.981 - E _{MOD}	$0.0145 \times \ln(P) + 0.8 - E_{\text{MOD}}$

E_{MOD} = an allowance of 0.004 for Modular UPSs applicable in the commercial 1500 – 10,000 W range

- EFLH = Equivalent Full Load Hours, per equation below and values provided in table¹⁸⁶⁷
= $(t_{0.25} \times 0.25 + t_{0.5} \times 0.5 + t_{0.75} \times 0.75 + t_{1.0} \times 1.0) \times 8760$ hours

Rated Output Power (P) in watts	UPS Product Class	Time spent at specified proportion of reference test load (t)				EFLH
		25%	50%	75%	100%	
P ≤ 1.5 kW	VFD	0.2	0.2	0.3	0.3	5913

¹⁸⁶⁵ Code of Federal Regulations, Energy Conservation Standards for Uninterruptible Power Supplies, effective January 10, 2022 (10 CFR 430.32(z)(3)).

¹⁸⁶⁶ ENERGY STAR Uninterruptible Power Supplies Final Version 2.0 Specification, effective January 1, 2019.

¹⁸⁶⁷ Calculation and inputs provided in ENERGY STAR Uninterruptible Power Supplies Final Version 2.0 Specification.

Rated Output Power (P) in watts	UPS Product Class	Time spent at specified proportion of reference test load (t)				EFLH
		25%	50%	75%	100%	
	VI or VFI	0	0.3	0.4	0.3	6570
1.5 kW < P ≤ 1.875 kW	VFD, VI, or VFI	0	0.3	0.4	0.3	6570

Default Energy Savings are provided below:¹⁸⁶⁸

Output Power Range	Output Power (kW) ¹⁸⁶⁹	Single-Normal Mode UPS Systems			Multiple-Normal Mode UPS Systems	
		VFD	VI	VFI	VFD _{25%} /VI _{75%}	VFD _{25%} /VFI _{75%}
P ≤ 0.300 kW	0.261	185.6	207.7	1,035.4	186.0	727.7
0.300 kW < P ≤ 0.350 kW	0.335	34.7	40.9	169.5	35.3	127.4
0.350 kW < P ≤ 0.700 kW	0.513	117.3	133.5	283.2	118.0	234.4
0.700 kW < P ≤ 1.500 kW	1.041	32.0	35.5	354.6	32.0	264.2
1.500 kW < P ≤ 1.875 kW	1.766	0.0	55.3	605.0	13.9	434.1

SUMMER COINCIDENT PEAK DEMAND SAVINGS

$$\Delta kW = \text{Size} * (1/\text{Eff}_{\text{AVGbase}} - 1/\text{Eff}_{\text{AVGee}}) * \text{CF}$$

Where:

CF_{IT} = Coincidence factor of UPS
= 1.0

Default Summer Peak Demand Savings are provided below based on defaults above:

Output Power Range	Single-Normal Mode UPS Systems			Multiple-Normal Mode UPS Systems	
	VFD	VI	VFI	VFD _{25%} /VI _{75%}	VFD _{25%} /VFI _{75%}
P ≤ 0.300 kW	0.0314	0.0316	0.1576	0.0314	0.1108
0.300 kW < P ≤ 0.350 kW	0.0059	0.0062	0.0258	0.0060	0.0194
0.350 kW < P ≤ 0.700 kW	0.0198	0.0203	0.0431	0.0200	0.0357
0.700 kW < P ≤ 1.500 kW	0.0054	0.0054	0.0540	0.0054	0.0402
1.500 kW < P ≤ 1.875 kW	0.0000	0.0084	0.0921	0.0021	0.0661

FOSSIL FUEL SAVINGS

N/A

¹⁸⁶⁸ Default savings are provided in a calculation file provided by VEIC that utilizes the ENERGY STAR qualified products list (as accessed on June 11, 2024) for the average power rating within each range. In circumstances where the use of the efficient and baseline efficiency formulas resulted in negative default savings, the average unit efficiency from qualified products within that power range was used instead of the ENERGY STAR product class formula. See “ENERGY STAR UPS Calculations_2024.xls” for more information.

¹⁸⁶⁹ Default output power is based on the average active output power rating of ENERGY STAR rated models falling into that specified range, as sourced from the ENERGY STAR Qualified Products List for Uninterruptible Power Supplies, as accessed on June 11, 2024.

DEEMED O&M COST ADJUSTMENT CALCULATION

N/A

MEASURE CODE: CI-MSC-UPSE-V04-250101

REVIEW DEADLINE: 1/1/2028

4.9.16 Energy Efficient Rectifier and High Wattage UPS

DESCRIPTION

This measure is for replacing an inefficient rectifier or high wattage uninterruptable (UPS) with an efficient unit in a data center, telecommunications, or similar facility that operates continuously. A rectifier converts alternating current (AC) to direct current (DC). UPS units provide backup power and draw constantly to keep batteries charged.

This measure applies to UPS's with a rated output power greater than 1,875 watts.

This measure was developed to be applicable to the following program types: TOS. If applied to other program types, the measure savings should be verified.

DEFINITION OF EFFICIENT EQUIPMENT

The efficient condition is a new rectifier or UPS whose efficiency in normal mode (not in energy saver mode) is at least 94%.¹⁸⁷⁰

DEFINITION OF BASELINE EQUIPMENT

The baseline condition is an existing rectifier or UPS whose efficiency in normal mode (not in energy saver mode) is less than 90%.¹⁸⁷¹

DEEMED LIFETIME OF EFFICIENT EQUIPMENT

The measure life is assumed to be 15 years.¹⁸⁷²

DEEMED MEASURE COST

The incremental cost is estimated at \$59 per kW of IT Load.¹⁸⁷³

LOADSHAPE

Loadshape is determined by the constant power draw by the Rectifier; default loadshape is Loadshape C53 – Flat.

COINCIDENCE FACTOR

The coincidence factor for the rectifier is assumed to be 1.0 due to equipment operating during peak period.

Algorithm

¹⁸⁷⁰ Switching mode rectifier (SMR) technologies allows for efficiencies as high as 96% according to the DOE, Office of Energy Efficiency & Renewable Energy, High-Efficiency, Wide-Band Three-Phase Rectifiers and Adaptive Rectifier Management. Accessed: 12/05/19 <https://www.energy.gov/eere/amo/high-efficiency-wide-band-three-phase-rectifiers-and-adaptive-rectifier-management>

¹⁸⁷¹ Mid-range efficiency for most low peak rectifiers (88%-92%) based on information from the DOE, Office of Energy Efficiency & Renewable Energy, High-Efficiency, Wide-Band Three-Phase Rectifiers and Adaptive Rectifier Management. Accessed: 12/05/19 <https://www.energy.gov/eere/amo/high-efficiency-wide-band-three-phase-rectifiers-and-adaptive-rectifier-management>

¹⁸⁷² California Municipal Utilities Association. Savings Estimation Technical Reference Manual 2017, Third Edition. Section 8.12, p. 8–15.

¹⁸⁷³ Based on market study of twenty, 1600 Volt Bridge Rectifiers, as sourced from Mouser Electronics online marketplace. Accessed: 12/05/19. https://www.mouser.com/Semiconductors/Discrete-Semiconductors/Diodes-Rectifiers/Bridge-Rectifiers/_/N-ax1mf?P=1yzxhysZ1yzxpaz

CALCULATION OF ENERGY SAVINGS

ELECTRIC ENERGY SAVINGS

$$\Delta kWh = kWh_{base} - kWh_{EE}$$

$$kWh_{base} = ((Load * H_{IT})/Eff_{base}) + ((Load * (1/ Eff_{base} - 1) * H_{Cool} * kW/Ton_{Cool} * 3412/12000)$$

$$kWh_{EE} = ((Load * H_{IT})/Eff_{EE}) + ((Load * (1/ Eff_{EE} - 1) * H_{Cool} * kW/Ton_{Cool} * 3412/12000)$$

Where:

- Load = Average IT load (output kW)
= Actual, typically at 20% of equipment rated load¹⁸⁷⁴
- H_{IT} = Annual hours of operation of rectifier or UPS
= 8760
- H_{cool} = Annual cooling system hours of operation
= Actual or defaults below:

System Size	Cooling Hours (H _{cool})
Small IT (≤ 50 kW) without air-side economizer	8760 hours ¹⁸⁷⁵
Small IT (> 50 kW) with air-side economizer	4380 hours ¹⁸⁷⁶

- Eff_{base} = Efficiency of existing rectifier or UPS
= Actual. If unknown assume 90%¹⁸⁷⁷
- Eff_{EE} = Efficiency of new rectifier or UPS
= Actual. If unknown assume 94%
- kW/Ton_{cool} = Cooling system efficiency (kW/Ton)

Cooling Equipment Type	Efficiency Calculation (kW/Ton _{cool})
Air-Cooled Chiller	kW/Ton _{Chiller} + kW _{chilled water pump} /Tons
Water-Cooled Chiller	kW/Ton _{Compressor} + (kW _{chilled water pump} + kW _{condensor water pump} + kW _{cooling tower fans})/Tons
Direct Expansion System	12/EER

SUMMER COINCIDENT PEAK DEMAND SAVINGS

$$\Delta kW = kW_{base} - kW_{EE}$$

$$kW_{base} = ((Load * CF_{IT})/Eff_{base}) + ((Load * CF_{cool} * (1/ Eff_{base} - 1) * kW/Ton_{Cool} * 3412/12000)$$

$$kW_{EE} = ((Load * CF_{IT})/Eff_{EE}) + ((Load * CF_{cool} * (1/ Eff_{EE} - 1) * kW/Ton_{Cool} * 3412/12000)$$

Where:

¹⁸⁷⁴ Based on industry knowledge of large telecom company set up.

¹⁸⁷⁵ Small IT systems are assumed to have no air-side economizer and to operate continuously throughout the year.

¹⁸⁷⁶ Larger IT systems are assumed to have an air-side economizer that allows the cooling system to be turned off for half the year. This corresponds to approximately a 45°F changeover temperature, which is a conservative assumption.

¹⁸⁷⁷ Mid-range efficiency for most low peak rectifiers (88%-92%) based on information from the DOE, Office of Energy Efficiency & Renewable Energy, High-Efficiency, Wide-Band Three-Phase Rectifiers and Adaptive Rectifier Management.

CF_{IT} = Coincidence factor of rectifier

= 1.0

CF_{cool} = Coincidence factor of cooling system

= 0.82

FOSSIL FUEL SAVINGS

N/A

WATER AND OTHER NON-ENERGY IMPACT DESCRIPTIONS AND CALCULATION

N/A

DEEMED O&M COST ADJUSTMENT CALCULATION

N/A

MEASURE CODE: CI-MSC-RECT-V04-250101

REVIEW DEADLINE: 1/1/2028

4.9.17 Energy Efficient Hydraulic Oils - Provisional Measure

DESCRIPTION

Industrial hydraulic systems use hydraulic oil to transfer input energy to output power. Hydraulic oils also protect critical components from premature wear. Energy efficient hydraulic oil lubricants meet these requirements and provide reduced energy consumption. Energy efficient hydraulic oils have a lower coefficient of friction which reduces the friction between two moving parts (rotating pump equipment and hydraulic oil). This lower coefficient of friction reduces the energy required to yield output power. Second, these oils have a high viscosity index which reduces the effect temperature has on the viscosity of the hydraulic oil. The high viscosity index allows constant viscosity over a range of operating temperatures which optimizes volumetric and mechanical efficiency at the pumps rated output. Additionally, energy efficient hydraulic oils reduce the operating temperature of the hydraulic system.

Manufacturers who use electric-motor-driven hydraulic systems have been found to reduce energy consumption by between 3 and 7%.

This measure was developed to be applicable to the following program types: NC, TOS and RF. If applied to other program types, the measure should be verified as a custom measure.

DEFINITION OF EFFICIENT EQUIPMENT

This is applicable for small, medium, and large manufacturers in all climate zones using electric motors to power their hydraulic system both inside and/or outside conditioned areas; or for all hydraulic systems on mobile equipment in all climate zones on Illinois.

DEFINITION OF BASELINE EQUIPMENT

The baseline equipment is defined as hydraulic systems using non-energy efficient industrial hydraulic oils which provides no energy efficiency benefits. In the formula below, the baseline equipment is where, $E_i = \text{zero}$.

DEEMED LIFETIME OF EFFICIENT EQUIPMENT

The expected measure life is assumed to be 10 years.

The ability to reduce energy consumption (energy efficiency) is an inherent characteristic in the oil which does not deplete over time. As long as the energy efficient oil is in use, it will provide energy efficiency.

DEEMED MEASURE COST

The actual incremental costs between an energy-efficient hydraulic oil and a standard hydraulic oil should be used.

LOADSHAPE

Loadshape C14: Indust. 1-shift (8/5) (e.g., comp. air, lights)

Loadshape C15: Indust. 2-shift (16/5) (e.g., comp. air, lights)

Loadshape C16: Indust. 3-shift (24/5) (e.g., comp. air, lights)

Loadshape C17: Indust. 4-shift (24/7) (e.g., comp. air, lights)

COINCIDENCE FACTOR

No coincidence factor though it is noted that reduced consumption for equipment will reduce the overall baseload power demand, especially if a construction operation or manufacturing operation demand more utility power in summer weather (e.g., construction ground work, rubber manufacturing, etc).

Algorithm

CALCULATION OF ENERGY SAVINGS

Savings are calculated based on a reduced coefficient of friction and the shear-stable high viscosity index value associated with energy-efficient hydraulic oils in hydraulic systems. The algorithm below for Energy Savings, is modeled after the Focus on Energy Emerging Technology Program M&V study.

ELECTRIC ENERGY SAVINGS

$$\Delta kWh = \text{MotorHP} * (0.746 \text{ kW/HP}) * (\% \text{MotorLoading} / \mu \text{Motor}) * \text{HOURS} * E_i$$

Where:

MotorHP = Rated horsepower of electric motor, summed when pumps are in series.

= Actual

%MotorLoading = Is dependent upon many factors including the part being manufactured, the polymer, the machine's specifications, and cycle time.

= Actual, calculated as (Average load / Full rated load)

= Estimated as 75%.¹⁸⁷⁸

μ Motor = Motor efficiency

= Actual. If unknown, estimated as 92% for motors in size range typically used.¹⁸⁷⁹

HOURS = Hours of operation per year

= Actual

E_i = Efficiency improvement due to use of energy efficient hydraulic oils

= Actual. If not measured, assume 3.3%.¹⁸⁸⁰

SUMMER COINCIDENT PEAK DEMAND SAVINGS

N/A

FOSSIL FUEL SAVINGS

N/A

WATER AND OTHER NON-ENERGY IMPACT DESCRIPTIONS AND CALCULATION

N/A

DEEMED O&M COST ADJUSTMENT CALCULATION

O&M savings from the necessary standard oil replacement over the lifetime of the energy efficient hydraulic oil (including oil cost, disposal costs, labor and avoided downtime) should be calculated. If additional savings from improved pump and valve lifetime can be demonstrated, these can also be included.

An example O&M cost calculation is provided below, relating to the standard hydraulic oil requiring 1 change out per year:

¹⁸⁷⁸ Most electric motors are designed to run at 50% to 100% of rated load, from Department of Energy "Determining Electric Motor Load & Efficiency", June 23, 2020.

¹⁸⁷⁹ Based on common size and type of motor - chart on pages 13-14, "Attachment C" of reference 9, the efficiency of a 50HP motor (TEFC type) at 1200 RPM is 92%. Or 75HP at 900 RPM at 75% TEFC type is 91.8%. These are common sizes and type for manufacturers.

¹⁸⁸⁰ Estimate based on review of a number of studies provided by ExxonMobil and saved in reference folders.

O&M Component	Cost
Oil cost	\$800
Oil disposal cost	\$80
Labor (4 hours per change at \$40/hr)	\$160
Downtime Production cost (2 hours at \$500 lost production cost per year)	\$1000
Total annual O&M benefit (1 change per year)	\$2040

MEASURE CODE: CI-MSC-EEHO-V01-210101

REVIEW DEADLINE: 1/1/2023

4.9.18 Energy Efficient Gear Lubricants - Provisional Measure

DESCRIPTION

Industrial gear reduction systems use gear oil to transfer input energy to output power. Gear oils also protect critical components from premature wear. Energy efficient gear oil lubricants meet these requirements and provide reduced energy consumption. Energy efficient gear oils have a lower coefficient of friction which reduces the friction between two moving parts (rotating pump equipment and hydraulic oil). This lower coefficient of friction reduces the energy required to yield output power. Second, these oils have a high viscosity index which reduces the effect temperature has on the viscosity of the hydraulic oil. The high viscosity index allows constant viscosity over a range of operating temperatures which optimizes volumetric and mechanical efficiency at the pumps rated output. Additionally, energy efficient gear oils reduce the operating temperature of the gear-reduction gearbox.

Manufacturers who use electric-motor-driven gear-reduction gearboxes can reduce energy consumption by up to 1% per gear-mesh (e.g., 3% efficiency for a 3-reduction gearbox).

This measure was developed to be applicable to the following program types: NC, TOS and RF. If applied to other program types, the measure should be verified as a custom measure.

DEFINITION OF EFFICIENT EQUIPMENT

This is applicable for small, medium, and large manufacturers in all climate zones using electric motors to power their gear reduction system both inside and/or outside conditioned areas; or for all gear reduction systems on mobile equipment in all climate zones on Illinois.

DEFINITION OF BASELINE EQUIPMENT

The baseline equipment is defined as a gearbox using non-energy efficient industrial gear lubricants which provides no energy efficiency benefits. In the formula below, the baseline equipment is where, $E_i = \text{zero}$.

DEEMED LIFETIME OF EFFICIENT EQUIPMENT

The expected measure life is assumed to be 10 years.

The ability to reduce energy consumption (energy efficiency) is an inherent characteristic in the oil which does not deplete over time. As long as the energy efficient oil is in use, it will provide energy efficiency.

DEEMED MEASURE COST

The actual incremental costs between an energy-efficient and a standard gear lubricant should be used.

LOADSHAPE

Loadshape C14: Indust. 1-shift (8/5) (e.g., comp. air, lights)

Loadshape C15: Indust. 2-shift (16/5) (e.g., comp. air, lights)

Loadshape C16: Indust. 3-shift (24/5) (e.g., comp. air, lights)

Loadshape C17: Indust. 4-shift (24/7) (e.g., comp. air, lights)

COINCIDENCE FACTOR

No coincidence factor though it is noted that reduced consumption for equipment will reduce the overall baseload power demand, especially if a construction operation or manufacturing operation demand more utility power in summer weather (e.g., construction ground work, rubber manufacturing, etc).

Algorithm

CALCULATION OF ENERGY SAVINGS

Savings are calculated based on a reduced coefficient of friction and the shear-stable high viscosity index value associated with energy-efficient gear oils in gear-reduction systems. The algorithm below for Energy Savings is modeled after the Focus on Energy Emerging Technology Program M&V study.

ELECTRIC ENERGY SAVINGS

$$\Delta kWh = \text{MotorHP} * (0.746 \text{ kW/HP}) * (\% \text{MotorLoading} / \mu \text{Motor}) * \text{HOURS} * E_i$$

Where:

MotorHP = Rated horsepower of electric motor, summed when pumps are in series.

= Actual

%MotorLoading = Is dependent upon many factors including the part being manufactured, the polymer, the machine's specifications, and cycle time.

= Actual, calculated as (Average load / Full rated load)

= Estimated as 75%.¹⁸⁸¹

μ Motor = Motor efficiency

= Actual. If unknown, estimated as 92% for motors in size range typically used.¹⁸⁸²

HOURS = Hours of operation per year

= Actual

E_i = Efficiency improvement due to use of energy efficient hydraulic oils

= Actual. If not measured, assume 1% per gear mesh.¹⁸⁸³

SUMMER COINCIDENT PEAK DEMAND SAVINGS

N/A

FOSSIL FUEL SAVINGS

N/A

WATER AND OTHER NON-ENERGY IMPACT DESCRIPTIONS AND CALCULATION

N/A

DEEMED O&M COST ADJUSTMENT CALCULATION

O&M savings from the necessary standard oil replacement over the lifetime of the energy efficient gear oil (including oil cost, disposal costs, labor and avoided downtime) should be calculated. If additional savings for improved gear box lifetime can be demonstrated, these can also be included.

¹⁸⁸¹ Most electric motors are designed to run at 50% to 100% of rated load, from Department of Energy "Determining Electric Motor Load & Efficiency", June 23, 2020.

¹⁸⁸² Based on common size and type of motor - chart on pages 13-14, "Attachment C" of reference 9, the efficiency of a 50HP motor (TEFC type) at 1200 RPM is 92%. Or 75HP at 900 RPM at 75% TEFC type is 91.8%. These are common sizes and type for manufacturers.

¹⁸⁸³ Estimate based on review of a number of studies provided by ExxonMobil and saved in reference folders.

MEASURE CODE: CI-MSC-EEGL-V01-210101

REVIEW DEADLINE: 1/1/2023

4.9.19 Smart Sockets

DESCRIPTION

Smart sockets achieve savings through the reduction of the standby load of the controlled appliance, as well as eliminating the operation of an appliance during unoccupied hours. The standby power consumption of home appliances and office equipment can be significantly reduced.

In a commercial office space, significant opportunity exists for savings from the reduction of plug loads, with power strips and timers being a key energy saving measure.¹⁸⁸⁴ Savings from smart sockets generally occurs during off-hours, when connected equipment continues to consume electricity while in standby mode or when off. Savings may also be achieved through the more precise scheduling of the appliance, so that it is not operating during unoccupied hours, though those savings have not been attempted to be quantified within this summary.

Smart sockets are ideal for all types of plugged-in devices such as small appliances (coffee maker, office heater, etc.), in-wall AC units, large office equipment, outlet lights, digital signs, decorative lighting, televisions, etc, though they provide the greatest energy savings when installed on equipment with higher wattage and standby power consumption. In a commercial office space, the shared photocopier is often the largest stand-alone user of electricity, with the highest standby power draw, so an ideal candidate for use with a smart socket. Note that a dedicated power supply is critical for your office photocopier.¹⁸⁸⁵ Also, note that the electrical amperage rating of the smart socket should be verified to suit the connected equipment. Desktop computers with peripheral equipment may be better served by an advanced power strip.

This measure was developed to be applicable to the following program types: DI, KITS. If applied to other program types, the measure savings should be verified.

DEFINITION OF EFFICIENT EQUIPMENT

The efficient case is the use of a smart plug with a standby power wattage of 2W or less. Should be UL listed. (Simply Conserve Smart Socket SS-15A1-WiFi has a standby power of less than or equal to 0.7).

DEFINITION OF BASELINE EQUIPMENT

The assumed baseline is an appliance or piece of office equipment plugged into an outlet (without a power strip) or into a standard power strip with surge protection that does not control connected loads. Note many ENERGY STAR appliances require power saving settings which will partially offset the savings potential of this measure. Where possible non-ENERGY STAR equipment should be plugged in to the socket to ensure savings are realized.

DEEMED LIFETIME OF EFFICIENT EQUIPMENT

The assumed lifetime of the smart socket is 7 years.¹⁸⁸⁶

DEEMED MEASURE COST

For direct install, the actual full equipment and installation cost (including labor) and for kits the actual full equipment cost should be used. If unknown for kits, use \$9.00/each.¹⁸⁸⁷

¹⁸⁸⁴ See Page 6 of New Buildings Institute, “Plug Load Savings Assessment: Part of the Evidence-based Design and Operations PIER Program,” California Energy Commission, Evidence-based Design and Operations PIER Program, March 2013.

¹⁸⁸⁵ From Ross Wiffler, “A Dedicated Power Supply is Critical for Your Office Copier”, Copiers & More, Small Business, Aug. 18th, 2015. <https://commonsensebusinesssolutions.com/a-dedicated-power-supply-is-critical-for-your-office-copier/>

¹⁸⁸⁶ This is an assumption consistent with 4.8.7 Advanced Power Strip – Tier 1 Commercial.

¹⁸⁸⁷ Based on cost from vendor of typical smart socket on the market, Simply Conserve Smart Socket by AM Conservation Group. 10 amp smart socket: \$8.92/each; 15 amp smart socket: \$9.00/each.

LOADSHAPE

Loadshape C47 – Standby Losses – Commercial Office¹⁸⁸⁸

COINCIDENCE FACTOR

N/A due to no savings attributable to standby losses between 1 and 5 PM.

Algorithm

CALCULATION OF ENERGY SAVINGS

ELECTRIC ENERGY SAVINGS

$$\Delta kWh^{1889} = (((W_{Base} * OnAdj) - W_{Eff}) * (hrs_{swkday} - hrs_{swkday-open})) + (((W_{Base} * OnAdj) - W_{Eff}) * (hrs_{wkend} - hrs_{wkend-open}))/1000 * weeks/year * ISR$$

Where:

W_{Base} = Standby power or On power consumption of connected appliance.

Use actual if known, or refer to tables below. If unknown, e.g. via kits, assume 9.4W¹⁸⁹⁰

Appliances assumed to be in standby mode:

Controlled Equipment ¹⁸⁹¹	Standby Power (W)
Coffee Maker	1.14
Television, CRT	3.06
Television, Rear Projection	6.97
Television, LCD ¹⁸⁹²	8.00
Set-top Box, DVR	36.68
Set-top Box, Digital Cable	17.83
Set-top Box, Satellite	15.66
Television/VCR	5.99
VCR	4.68
Computer, Desktop	2.84
Computer Notebook	8.90
Multifunction Device, Inkjet	5.26
Multifunction Device, Laser	3.12

¹⁸⁸⁸ As referenced in 4.8.7 Advanced Power Strip – Tier 1 Commercial, Loadshapes were calculated from empirical studies and compared to the existing loadshape in Volume 1, Table 3.5. The studies were:

Acker, Brad *et al*, “Office Space Plug Load Profiles and Energy Saving Interventions,” 2012 ACEEE Summer Study on Energy Efficiency in Buildings.

Sheppy, M. *et al*, “Reducing Plug Loads in Office Spaces” Hawaii and Guam Energy Improvement Technology Demonstration Project, NREL/NAVFAC (January 2014).

¹⁸⁸⁹ Savings algorithm reconstructed from weekday and weekend savings information in Acker, Brad *et al*, “Office Space Plug Load Profiles and Energy Saving Interventions,” 2012 ACEEE Summer Study on Energy Efficiency in Buildings, and verified against savings in Acker *et al* and savings in: BPA, “Smart Power Strip Energy Savings Evaluation: Ross Complex,” (2011). Office stations are assumed to have zero or minimal standby losses during normal operating hours. Method shown in “Commercial Tier 1 APS Calculations – IL TRM.xlsx”.

¹⁸⁹⁰ Average connected wattage found in Guidehouse, ‘ComEd Small Business Kits CY2020 Impact Evaluation Report 2021-04-01 Final.pdf’.

¹⁸⁹¹ See Standby Power Summary Table contained in “Standby Power”, Lawrence Berkeley National Laboratory, Building Technology and Urban Systems Division, <https://standby.lbl.gov/data/summary-table/>

¹⁸⁹² From “iTECH evaluation on the SmartSocket,” ITECH Electronic Co., LTD, 1/28/19. IoT – Related Technical Articles. <https://www.itechate.com/uploadfiles/2019/01/201901281143214321.pdf>.

Controlled Equipment ¹⁸⁹¹	Standby Power (W)
Scanner, Flatbed	2.48

Appliances assumed to be in on mode:

Controlled Equipment ¹⁸⁹³	On Power (W)
Light	10.4
Fan	70
Space Heater	450
Water Cooler	100

- OnAdj = Adjustment for wattages of appliances that are powered on during out of hours
= 50%¹⁸⁹⁴ for appliances in on mode
=100% for appliances in standby mode and for unknown
- W_{Eff} = Standby power consumption of smart socket. If unknown, assume 0.7W¹⁸⁹⁵.
- hr_{Swkday} = total hours during the work week (Monday 7:30 AM to Friday 5:30 PM)
= 106
- hr_{Swkend} = total hours during the weekend (Friday 5:30 PM to Monday 7:30 AM)
= 62
- hr_{Swkday-open} = hours the office is open during the work week. If unknown, assume 48 hours.
- hr_{Swkend-open} = hours the office is open during the weekend. If unknown, assume 10 hours. ¹⁸⁹⁶
- weeks/year = number of weeks per year
= 52.2
- ISR = In Service Rate
= Assume 0.969 for commercial Direct Install application¹⁸⁹⁷
= Assume 0.28 for kits that include two smart sockets¹⁸⁹⁸
= Assume 0.36 for kits that include one smart socket¹⁸⁹⁹

¹⁸⁹³ See Standby Power Summary Table contained in “Standby Power”, Lawrence Berkeley National Laboratory, Building Technology and Urban Systems Division, <https://standby.lbl.gov/data/summary-table/>

¹⁸⁹⁴ In the absence of empirical data, a 50% adjustment for appliances assumed to be on during out of hours is applied.

¹⁸⁹⁵ Average smart socket wattage found in Guidehouse, ‘ComEd Small Business Kits CY2020 Impact Evaluation Report 2021-04-01 Final.pdf’.

¹⁸⁹⁶ Unknown hours are based on a Guidehouse review of open hours for 487 participants in this measure.

¹⁸⁹⁷ Based upon review of the PY2 and PY3 ComEd Direct Install Residential program surveys. This value could be modified based upon commercial application evaluation.

¹⁸⁹⁸ This ISR is based on the results of surveys of ComEd Small Business Kit recipients conducted in the Spring of 2021. This result includes the reduction in the installation rate from the survey respondents that indicated they did not install the application which is necessary to use the smart socket as intended.

¹⁸⁹⁹ This ISR is based on the results of the surveys of ComEd Small Business Kit recipients conducted in the Spring of 2021. It is based on an estimate of what the ISR would be if the kit only included a single socket even though all the kits distributed by ComEd included two sockets. Similar to the ISR for the two socket kits, this ISR accounts for the reduction in the installation rate from the survey respondents that indicated they did not install the application which is necessary to use the smart socket as intended.

For example, a smart socket is direct installed with a LCD Television in an office open 9.6 hours per day (48 hours per week) on weekdays and 10 hours on weekends:

$$\begin{aligned}\Delta\text{kWh} &= (((8 * 1) - 0.7) * (106 - 48)) + (((8 * 1) - 0.7) * (62 - 10))/1000 * 52.2 * 0.969 \\ &= 40.6 \text{ kWh}\end{aligned}$$

SUMMER COINCIDENT PEAK DEMAND SAVINGS

N/A due to no savings attributable to standby losses between 1 and 5 PM.

FOSSIL FUEL SAVINGS

N/A

WATER AND OTHER NON-ENERGY IMPACT DESCRIPTIONS AND CALCULATION

N/A

DEEMED O&M COST ADJUSTMENT CALCULATION

N/A

MEASURE CODE: CI-MSC-SSOC-V02-250101

REVIEW DEADLINE: 1/1/2029

4.9.20 Lithium Ion Fork Truck Batteries

DESCRIPTION

This measure applies to electric fork trucks used in commercial, industrial, and warehouse environments. Electric fork trucks with lithium ion battery systems are more efficient than electric fork trucks with traditional lead acid battery systems because the lithium ion batteries have lower internal resistance. This allows the batteries to transfer power faster, reduces waste heat, and reduces standby losses.

Electric fork trucks can be purchased with lithium ion battery systems or an existing electric fork truck can be retrofitted to use a lithium ion battery system. An electric fork truck can be converted to a lithium ion battery system by removing the lead acid battery and installing a battery case that includes a series of lithium ion batteries and the appropriate ballast to meet weight and balance specifications for the fork truck. The lithium ion battery case is a one-for-one equivalent replacement of the lead acid battery in respect to capacity, shape, and weight. The fork truck may require a new charger to work with the new lithium ion battery system. Electric fork trucks can also replace propane or diesel powered fork truck in a one to one scenario. Where a facility normally operates a fleet of fossil-fueled fork trucks a fossil-fuel baseline should be considered for any additional fork trucks that might be purchased beyond the current quantity of trucks operating at the facility.

This measure was developed to be applicable to the following program types: TOS and RF. If applied to other program types, the measure savings should be verified.

DEFINITION OF EFFICIENT EQUIPMENT

Class I, Class II, or Class III fork trucks that are powered by lithium ion batteries with minimum 8-hour shift operation five days per week.

DEFINITION OF BASELINE EQUIPMENT

Class I, Class II, or Class III fork trucks that are powered by lead acid batteries or fossil-fuels such as propane or diesel with minimum 8-hour shift operation five days per week.

DEEMED LIFETIME OF EFFICIENT EQUIPMENT

15 years.¹⁹⁰⁰

DEEMED MEASURE COST

Costs will vary significantly based on the capacity and class of the fork truck. Costs for this measure should be determined by actual quotes obtained from manufacturers and estimated labor. If not available, it is estimated that a new lithium ion fork truck would cost \$34,400 compared with \$17,200 for a new lead-acid battery fork truck, \$24,200 for a propane and \$25,100 for a diesel fork truck.¹⁹⁰¹

Converting a lead acid battery fork truck to a lithium ion battery system would cost \$17,000.¹⁹⁰²

LOADSHAPE

Loadshape C14 - Indust. 1-shift (8/5) (e.g., comp. air, lights)

Loadshape C15 - Indust. 2-shift (16/5) (e.g., comp. air, lights)

¹⁹⁰⁰ Lifetime of measure assumed to be limited by the lifetime of the lithium ion charger. See reference file Suzanne Foster Porter et al., "Analysis of Standards Options for Battery Charger Systems", (PG&E, 2010), 45.

¹⁹⁰¹ Estimates for new lithium ion, propane and diesel from Dennis, Allen and Vairamohan, Bashkar. "EPRI Forklift (Lift Truck) Comparison with Capital Costs." Electric Power Research Institute. Accessed April 19, 2022.

<https://et.epri.com/ForkliftCalculator.html>. A new lead-acid battery is estimated to be approximately half the cost of a lithium ion, as suggested in Thomas, Pete. "Is a Lithium Ion Forklift Battery Worth the Extra Expense?" Toyota Material Handling Northern California. <https://www.tmhnc.com/blog/lithium-ion-forklift-battery-cost-and-runtime>.

¹⁹⁰² Thomas, Pete. "Is a Lithium Ion Forklift Battery Worth the Extra Expense?" Toyota Material Handling Northern California. Accessed May 5, 2021. <https://www.tmhnc.com/blog/lithium-ion-forklift-battery-cost-and-runtime>.

Loadshape C16 - Indust. 3-shift (24/5) (e.g., comp. air, lights)

Loadshape C17 - Indust. 4-shift (24/7) (e.g., comp. air, lights)

COINCIDENCE FACTOR

It is assumed that lead acid battery fork trucks are charged overnight. Therefore, the coincidence factor is assumed to be 0.0 for 1-shift and 2-shift operations and 1.0 for 3-shift and 4-shift operations.¹⁹⁰³

Algorithm

CALCULATION OF ENERGY SAVINGS

ELECTRIC ENERGY SAVINGS AND FOSSIL FUEL SAVINGS

Non-fuel switch (baseline of lead-acid fork truck):

$$\Delta kWh = (CAP * DOD * CHG * (1/ EE_{LAB} - 1/EE_{LIB}))$$

Where:

CAP = Capacity of Battery

= Use actual battery capacity, otherwise use a default value of 35 kWh¹⁹⁰⁴

DOD = Depth of Discharge

= Use actual depth of discharge, otherwise use a default value of 80%.¹⁹⁰⁵

CHG = Number of Charges per year

= Use actual number of annual charges, if unknown use values below based on the type of operation

Standard Operations	Number of Charges per year
1-shift (8 hrs/day – 5 days/week)	520
2-shift (16 hrs/day – 5 days/week)	1,040
3-shift (24 hrs/day – 5 days/week)	1,560
4-shift (24 hrs/day – 7 days/week)	2,184

EE_{LAB} = Energy Efficiency of Lead Acid Battery

= Use actual efficiency of battery for retrofit, for new or unknown use 46%¹⁹⁰⁶

EE_{LIB} = Energy Efficiency of Lithium Ion Battery

= Use actual efficiency of battery, if unknown use 73%¹⁹⁰⁶

¹⁹⁰³ Matley, Ryan. May 29, 2009. "Industrial Battery Charger Energy Savings Opportunities." Emerging Technologies Program Application Assessment Report #0808. Pacific Gas & Electric.

¹⁹⁰⁴ Renquist, Jacob V., Brian Dickman, and Thomas H. Bradley. June 19, 2012. "Economic comparison of fuel cell powered forklifts to battery powered forklifts." International Journal of Hydrogen Energy, Volume 37, Issue 17.

¹⁹⁰⁵ Matley, Ryan. May 2009. "Measuring Energy Efficiency Improvements in Industrial Battery Chargers." Energy Systems Laboratory.

¹⁹⁰⁶ Abdulhameed, Alshaebi, Husam Dauod, and Sang Won Yoon. May 2017. "Evaluation of Different Forklift Battery Systems Using Statistical Analysis and Discrete Event Simulation." Industrial and Systems Engineering Conference. Pittsburg, PA.

Fuel switch measures (baseline of propane or diesel fork truck):

Fuel switch measures must produce positive total lifecycle energy savings (i.e., reduction in Btus at the premises) in order to qualify. This is determined as follows (note for early replacement measures the lifetime savings should be calculated by calculating savings for the remaining useful life of the existing equipment and for the remaining measure life):

$$\Delta\text{SiteEnergySavings (MMBtu)} = (\text{CAP} * \text{DOD} * \text{CHG} * (1/ \text{EE}_{\text{BASE}} - 1/\text{EE}_{\text{LIB}})) * 3,412/1,000,000$$

Where:

- EE_{BASE} = Energy efficiency of baseline fork truck. If unknown, assume the efficiency values below based on the type of fork truck.¹⁹⁰⁷
 - = 20.4% for Propane
 - = 20.5% for Diesel
- 3,412 = Btu per kWh
- 1,000,000 = Btu per MMBtu

If SiteEnergySavings calculated above is positive, the measure is eligible.

Calculate savings as follows:

$$\Delta\text{kWh} = \Delta\text{SiteEnergySavings} * 1,000,000 / 3,412$$

Savings for each shift operation and baseline technology type using defaults provided above are provided below:

Standard Operations	Lead Acid	Diesel		Propane	
	Δ Elec (kWh)	ΔSiteEnergy Savings (MMBtu)	ΔSiteEnergy Savings (ΔkWh)	ΔSiteEnergy Savings (MMBtu)	ΔSiteEnergy Savings (ΔkWh)
1-shift (8 hrs/day – 5 days/week)	11,707	174	51,079	175	51,427
2-shift (16 hrs/day – 5 days/week)	23,414	349	102,158	351	102,855
3-shift (24 hrs/day – 5 days/week)	35,121	523	153,238	526	154,282
4-shift (24 hrs/day – 7 days/week)	49,169	732	214,533	737	215,995

SUMMER COINCIDENT PEAK DEMAND SAVINGS

It is assumed there is zero peak demand savings.

¹⁹⁰⁷ Dennis, Allen and Vairamohan, Bashkar. “EPRI Forklift (Lift Truck) Comparison with Capital Costs.” Electric Power Research Institute. Accessed April 19, 2022. <https://et.epri.com/ForkliftCalculator.html>. Tank-to-wheel efficiency is based on dividing output electricity by input propane energy, assuming HHV of 91,333 BTU/gallon for propane and 138,500 BTU/gallon for diesel.

FOSSIL FUEL SAVINGS

Calculation provided together with Electric Energy Savings above.

WATER AND OTHER NON-ENERGY IMPACT DESCRIPTIONS AND CALCULATION

N/A

DEEMED O&M COST ADJUSTMENT CALCULATION

Lithium ion batteries offer several O&M advantages over lead acid batteries. These benefits include, but are not limited to:

- Lithium ion batteries charge must faster, which results in less downtime.¹⁹⁰⁸
- There is no requirement for changing out batteries at the end of a shift or having multiple spare batteries in stock.¹⁹⁰⁸ A 3-shift operation would require a facility to have three separate lead acid batteries for each fork truck, so they could swap out batteries at the end of each shift. A lithium ion battery is charged while still in the fork truck and can use opportunity charging during employee breaktime.
- Fewer maintenance issues and no requirement for battery watering¹⁹⁰⁸
- Longer operating life.¹⁹⁰⁹ Lithium ion batteries can last nearly four times as long as lead acid batteries.

These benefits should be considered and evaluated on a project-by-project basis. It is estimated that lithium ion fork truck adoption saves a facility 65 labor hours per truck on an annual basis.¹⁹¹⁰

COST EFFECTIVENESS SCREENING AND LOAD REDUCTION FORECASTING WHEN FUEL SWITCHING

This measure can involve fuel switching from fossil fuel to electric.

For the purposes of forecasting load reductions due to fuel switch projects per Section 16-111.5B, changes in site energy use at the customer’s meter (using ΔkWh algorithm below) adjusted for utility line losses (at-the-busbar savings), customer switching estimates, NTG, and any other adjustment factors deemed appropriate, should be used.

The inputs to cost effectiveness screening should reflect the actual impacts on the electric and fuel consumption at the customer meter and, for fuel switching measures, this will not match the output of the calculation/allocation methodology presented in the “Fuel Switch Measures” section above. Therefore in addition to the calculation of savings claimed, the following values should be used to assess the cost effectiveness of the measure.

$$\begin{aligned} \Delta\text{Therms} &= [\text{Fossil Fuel Consumption Saved}] \\ &= [\text{CAP} * \text{DOD} * \text{CHG} * \text{EE}_{\text{LIB}}/\text{EE}_{\text{BASE}} * 3412/100,000] \\ \Delta\text{kWh} &= [\text{Electric Consumption Added}] \\ &= - [\text{CAP} * \text{DOD} * \text{CHG}] \end{aligned}$$

MEASURE CODE: CI-MSC-LION-V03-250101

REVIEW DEADLINE: 1/1/2028

¹⁹⁰⁸ Abdulhameed, Alshaebi, Husam Dauod, and Sang Won Yoon. May 2017. “Evaluation of Different Forklift Battery Systems Using Statistical Analysis and Discrete Event Simulation.” Industrial and Systems Engineering Conference. Pittsburg, PA.

¹⁹⁰⁹ Mongird, Kendall, Viswanathan, Vilayanur V., Balducci, Patrick J., Alam, Md Jan E., Fotedar, Vanshika, Koritarov, V S., and Hadjerioua, Boualem. July 2019. "Energy Storage Technology and Cost Characterization Report". U.S. Department of Energy – HydroWires. <https://doi.org/10.2172/1573487>.

¹⁹¹⁰ Abdulhameed, Alshaebi, Husam Dauod, and Sang Won Yoon. May 2017. “Evaluation of Different Forklift Battery Systems Using Statistical Analysis and Discrete Event Simulation.” Industrial and Systems Engineering Conference. Pittsburg, PA.

4.9.21 Building Operator Certification

DESCRIPTION

Building Operator Certification (BOC) is a training and certification program for commercial and public sector building operators. The curriculum teaches participants how to improve building comfort and efficiency by optimizing the building’s systems. BOC curriculums provide participants with knowledge about system operations, proper maintenance practices, occupant communication, and occupant comfort. Participants realize energy savings by utilizing the knowledge gained to improve their building operations through O&M and capital measures.

Evaluators in Illinois used differing levels of engagement with participants to estimate savings from the BOC training. While deeming savings does not fully capture the individual and varied actions that participants made as a result of their BOC training, it is a reasonable approach to better align the expected level of impacts and program expenditures with evaluation expenditures. Deemed savings for this measure represent a weighted average of analyses’ results from several Illinois BOC program evaluations. The evaluations estimated net savings and were developed per square foot of building area to account for the diversity of building sizes across Illinois. All savings estimating algorithms presented in this work paper are for net savings. Participants are required to complete a rigorous BOC course and can only claim savings for the facilities for which the individual taking the course are responsible.

The 2023 IL-TRM v11.0 will be used to verify savings for 2021 and 2022 participants, and these results will be included in the final 2022 BOC evaluations (produced by April 30, 2023). This will include 2 years’ worth of participants due to the annualization of savings for 2022 participants and the transition year of 2021 to the deemed approach.

This measure was developed to be applicable to the following program types: TOS. If applied to other program types, the measure savings should be verified.

DEFINITION OF EFFICIENT EQUIPMENT

The efficient case is facilities operated by participants who complete a BOC training program. Participants must complete either the BOC Level I or Level II course and obtain a certificate of completion to be eligible for savings¹⁹¹¹. Eligible BOC programs must cover the following subject areas:

BOC Level I

- Efficient Operation of HVAC Systems
- Measuring and Benchmarking Energy
- Efficient Lighting Fundamentals
- HVAC Controls Fundamentals
- Indoor Environmental Quality
- Common Opportunities for Low-Cost Operational Improvement

BOC Level II

- Building Scoping and Operational Improvements
- Optimizing HVAC Controls for Energy Efficiency
- Introduction to Building Commissioning
- Water Efficiency for Building Operators
- Project Peer Exchange

The BOC course must include formal instruction (i.e., lectures), individual projects and group exercises, bringing the total course time to at least 61 hours. Participants must obtain a training certificate of completion to be eligible for savings. Individuals who participate are not eligible for savings more than twice over the measure life, once for BOC Level I and another for BOC Level II. The entire floor area for any given building can only be used once over the measure life, and evaluators will verify attendees’ participation year-over-year.

The savings factors for this measure were developed based on an examination of savings using a weighted average approach from several similar BOC programs. The table below outlines the referenced evaluation studies, and key

¹⁹¹¹ Future evaluation research could explore savings differences between Level I and Level II participants.

parameters which were inputs to this measure characterization. It is important to note that the savings information referenced is net. Therefore, this measure does not require the additional application of a net-to-gross ratio.

No previous custom study of customer participation in BOC shall inform eligibility for this measure.

Utility or Program Administrator	Year	Participants	Average Building Area	MWh/ Participant	kW/ Participant	Therm/ Participant	Incremental Measure Costs (\$/Participant) ¹⁹¹²
Ameren Illinois ¹⁹¹³	2020	10	140,137	60.002	0.83	987	\$253.94
Ameren Illinois ¹⁹¹⁴	2019	12	408,309	64.421	12.80	3,615	\$114.93
Ameren Illinois ¹⁹¹⁵	2021	8	502,944	23.650	0.00	0	\$0.00
ComEd ¹⁹¹⁶	2020	33	319,068	132.600	14.70	N/A	\$8,878.79
ComEd ¹⁹¹⁷	2021	2	517,250	20.755	1.55	N/A	\$9,310.50
Nicor Gas ¹⁹¹⁸	2021	3	517,250	0.000	0.00	234	\$0.00
Weighted Average ¹⁹¹⁹			344,708	91.994	10.00	1,635	\$4,640.29

DEFINITION OF BASELINE EQUIPMENT

The baseline is building operations as they existed before the participant completed the BOC training course.

DEEMED LIFETIME OF EFFICIENT EQUIPMENT

The measure life for BOC savings is 13 years¹⁹²⁰. Based on analyzed research, assume 42%¹⁹²¹ of BOC savings are derived from O&M measures that have a 4-year measure life¹⁹²². This should be handled similar to other midlife adjustments, where after 4 years, a midlife adjustment factor of 58% is applied for the remaining nine years of the measure life.

¹⁹¹² Total incremental measure costs from the evaluation, net of O&M adjustments (if applicable), divided by the number of BOC participants.

¹⁹¹³ Opinion Dynamics, ‘Ameren Illinois Company 2020 Business Program Impact Evaluation Report, Final’, April 28th 2021.

¹⁹¹⁴ Opinion Dynamics, ‘Ameren Illinois Company 2019 Business Program Impact Evaluation Report, Final’, April 30th 2020.

¹⁹¹⁵ Opinion Dynamics, ‘Ameren Illinois Company 2019 Business Program Impact Evaluation Report, Final’, April 29th 2022.

¹⁹¹⁶ The ComEd evaluation includes both 2018 and 2019 participants. The interview sample did not stratify by program year, so the savings per participant are the same for each year. Guidehouse, ‘ComEd Building Operator Certification Pilot Impact Evaluation Report’, April 12th, 2021.

¹⁹¹⁷ Guidehouse, ‘ComEd Building Operator Certification Pilot Impact Evaluation Report’, April 19th, 2022.

¹⁹¹⁸ Guidehouse completed follow-up interviews with 2018 – 2020 participants from ComEd’s program which also had gas service. Three interviews were completed, and all were Nicor Gas customers who completed no cost scheduling and usage tracking. The savings for these participants was calculated following the methodology used to determine the savings for ComEd’s CY2022 Building Operator Certification Pilot.

¹⁹¹⁹ The weighted average numbers are used to determine the savings parameters within this measure. The savings parameters are set so the participated weighted average savings using the TRM algorithm, including the building area cap, equals the participant weighted average savings from the referenced evaluation studies.

¹⁹²⁰ Average measure life of capital measures from the ComEd CY2020 evaluation.

¹⁹²¹ Weighted average from referenced evaluation studies which outlined lifetime information.

¹⁹²² EUL for operational updates when the controls type is unknown. See Attachment B:Effective Useful Life for Custom Measure. Effective Useful Life for Retro-commissioning and Behavior Programs memo by Guidehouse, September 17, 2019.

DEEMED MEASURE COST

The deemed training measure cost is \$1,695.¹⁹²³ In addition, the incremental cost of capital and O&M measures should also be included. If unknown, use an incremental measure cost of \$0.014/ft².¹⁹²⁴

LOADSHAPE

C23 – Commercial Ventilation

COINCIDENCE FACTOR

The demand savings factor (C_d) is already based upon coincident savings, and thus there is no additional coincidence factor for this characterization.

Algorithm

CALCULATION OF ENERGY SAVINGS

ELECTRIC ENERGY SAVINGS

$$\Delta kWh = C_e * Area$$

Where

Area = Building area operated by the participant. The maximum eligible area per participant is 500,000 ft². In the event there are multiple participants who operate the same building (i.e. service address), or group of buildings, the program administrator can only claim savings on building square footage once (i.e., they cannot claim savings based on the same square footage for multiple participants), unless the managed square footage exceeds 500,000 ft²; in which case, the program administrator can continue to claim savings up to the 500,000 ft² per participant cap until the total square footage has been accounted for.

C_e = unit area kWh savings constant per participant¹⁹²⁵, 0.274 kWh/ft²/participant

SUMMER COINCIDENT PEAK DEMAND SAVINGS

$$kW = C_d * Area / 1000$$

Where

C_d = Unit demand savings constant¹⁹²⁶, 0.03 W/ft² (capped)/participant

1000 = unit conversion from W to kW

FOSSIL FUEL SAVINGS

$$Therms = C_g * Area$$

Where

¹⁹²³ The current price to take the BOC training and certification in Illinois. <https://www.boccentral.org/training/illinois>. Accessed May 2022.

¹⁹²⁴ Based on evaluated measure incremental costs, net of O&M adjustments when available, from Ameren Illinois and ComEd BOC programs in Illinois.

¹⁹²⁵ Average net savings per participant from the evaluations referenced. See table of evaluations in the Definition of Efficient Equipment section of this measure.

¹⁹²⁶ Average net demand savings per participant from the evaluations referenced. See table of evaluations in the Definition of Efficient Equipment section of this measure.

C_g = Unit gas savings constant¹⁹²⁷, 0.0046 therms/ft² (capped)/participant

WATER AND OTHER NON-ENERGY IMPACT DESCRIPTIONS AND CALCULATION

N/A

Water and other non-energy impacts could be added in future updates.

DEEMED O&M COST ADJUSTMENT CALCULATION

N/A

MEASURE CODE: CI-MSC-BOC-V02-250101

REVIEW DEADLINE: 1/1/2029

¹⁹²⁷ Average net natural gas savings per participant from the evaluations referenced. See table of evaluations in the Definition of Efficient Equipment section of this measure.

4.9.22 Warm-Mix Asphalt Chemical Additives

DESCRIPTION

Warm-Mix Asphalt (WMA) is the name for a variety of technologies that allow for production and placement of asphalt at temperatures lower than traditional Hot-Mix Asphalt (HMA). The production temperature of WMA is typically 25°F to 90°F below that of HMA, resulting in reduced energy consumption. The actual temperature reduction depends upon the warm mix technology used. Currently, there are three categories of WMA technologies: asphalt foaming technologies, organic additives, and chemical additives.

The asphalt foaming technologies include a variety of processes to foam asphalt, including water-injecting systems, damp aggregate, or the addition of a hydrophilic material such as a zeolite. In the asphalt plant, the water turns to steam, disperses throughout the asphalt, and expands the binder, providing a corresponding temporary increase in volume and fluids content, similar in effect to increasing the binder content. Chemical additives often include surfactants that aid in coating and lubrication of the asphalt binder in the mixture. Lastly, organic additives are typically special types of waxes that cause a decrease in binder viscosity above the melting point of the wax.

In addition to energy savings, using WMA in place of HMA reduces greenhouse gas emissions and provides multiple non-energy benefits, such as better compaction, cool-weather paving, longer haul distances, and improved working conditions for the paving crew (reduction of fumes and odors). Warm-mix chemical additives allow for the mixing and placement of asphalt at temperatures lower than traditional HMA while maintaining similar strength, durability, and performance characteristics.

This measure is applicable to the industrial market with the end user in the transportation sector. WMA can be used in any climate, as the lower mix temperature allows WMA to be used in cooler ambient conditions than traditional HMA.

This measure was developed to be applicable to the following program types: TOS. If applied to other program types, the measure savings should be verified.

DEFINITION OF EFFICIENT EQUIPMENT

The efficient case is WMA. WMA is generally produced at temperatures ranging from 25°F to 90°F lower than HMA.¹⁹²⁸

General WMA technologies can be categorized as chemical additives, organic additives, and water-based foaming methods. Chemical additives reduce the internal friction between aggregate particles and thin films of binders when subjected to high shear rates during mixing and high shear stress during compaction. In contrast, the other two WMA methods rely on reduction of binder viscosity.

DEFINITION OF BASELINE EQUIPMENT

The baseline case is traditional HMA. HMA is traditionally mixed between 280°F and 320°F.¹⁹²⁹

DEEMED LIFETIME OF EFFICIENT EQUIPMENT

The measure life is 1 year. Savings occur during production, and last only as long as the production runs. Since savings and costs scale to tons of asphalt production, a 1-year measure life appropriately tracks lifecycle savings.

¹⁹²⁸ West, R.C., M.C. Rodezno, G. Julian, B.D. Prowell, B. Frank, L.V. Osborn, & A.J. Kriech (2014). "NCHRP Report 779:Field Performance of Warm-Mix Asphalt Technologies. Transportation Research Board of the National Academies", Washington, D.C. doi:10.17226/22272.

¹⁹²⁹ West, R.C., M.C. Rodezno, G. Julian, B.D. Prowell, B. Frank, L.V. Osborn, & A.J. Kriech (2014). "NCHRP Report 779:Field Performance of Warm-Mix Asphalt Technologies. Transportation Research Board of the National Academies", Washington, D.C. doi:10.17226/22272.

DEEMED MEASURE COST

The costs of WMA depend primarily on the type of WMA technology that is used. Of the WMA technology options, water-injection asphalt foaming typically have the lowest cost per ton. Water injection WMA technologies have a lower incremental cost at around \$0.08 per ton.¹⁹³⁰

Compared to other WMA technologies, additive based WMA technologies increase the mix costs by \$2.50 per ton¹⁹³¹ due to the cost of chemicals and freight costs.

LOADSHAPE

N/A

COINCIDENCE FACTOR

N/A

Algorithm

CALCULATION OF ENERGY SAVINGS

Energy savings are dependent on multiple factors that primarily affect the production of WMA. The following factors have been identified as the primary contributors to energy consumption:

- Mixing drum temperature
- Additive type

ELECTRIC ENERGY SAVINGS

N/A.

SUMMER COINCIDENT PEAK DEMAND SAVINGS

N/A.

FOSSIL FUEL SAVINGS

Average temperature reduction achieved by plants that reduce mix production temperature when using WMA must be determined to estimate reductions in energy consumption. In practice, WMA production temperatures when using water-injection foaming technologies are typically about 25°F lower than those for hot mix asphalt (HMA) using the same mix design. WMA produced with additives tends to have substantially lower mixing temperatures. For the purpose of estimating energy savings, a temperature difference of 50°F is assumed for additive-type WMA compared to HMA using the same mix design.

$$therms_{savings} = tons \times SF$$

Where:

- tons = Tons of asphalt produced
- SF = WMA production savings factor (therms/ton)
= See Table for SF for Water Injection Foaming and Additives

¹⁹³⁰ West, R.C., M.C. Rodezno, G. Julian, B.D. Prowell, B. Frank, L.V. Osborn, & A.J. Kriech (2014). “NCHRP Report 779:Field Performance of Warm-Mix Asphalt Technologies. Transportation Research Board of the National Academies”, Washington, D.C. doi:10.17226/22272.

¹⁹³¹ West, R.C., M.C. Rodezno, G. Julian, B.D. Prowell, B. Frank, L.V. Osborn, & A.J. Kriech (2014). “NCHRP Report 779:Field Performance of Warm-Mix Asphalt Technologies. Transportation Research Board of the National Academies”, Washington, D.C. doi:10.17226/22272.

Energy Savings by mixing temperature reduction

WMA Production Technology	[A] Energy Savings ¹⁹³² (therms/Δ°F/ton)	[B] Temperature Reduction (°F)	[C] = [A]*[B] SF (therms/ton)
Water Injection Foaming	0.011	25	0.275
Additives	0.011	50	0.55
Custom Documented	0.011	Custom	Calculated

Example:

A plant producing 1,000 ton asphalt everyday now decides to adopt additives for energy savings and non energy benefits. The savings for that plant will be computed:

$$\begin{aligned} \text{Savings} &= 1,000 \text{ tons} * 0.55 \text{ (therms/ton)} \\ &= 550 \text{ therms saved.} \end{aligned}$$

WATER AND OTHER NON-ENERGY IMPACT DESCRIPTIONS AND CALCULATION

In addition to reduced energy consumption, reduction in production temperatures results in reduced greenhouse gas emissions from the combustion process and any emissions from the mixed asphalt. The reduction of emissions, fumes, and odors results in a healthier work environment for production operators, truck drivers, and application workers. The lower temperature mix also allows for an extended paving season, night paving, and longer hauling distances for the WMA in comparison to HMA with faster application times.

DEEMED O&M COST ADJUSTMENT CALCULATION

N/A

MEASURE CODE: CI-MSC-WMIX-V02-240101

REVIEW DEADLINE: 1/1/2030

¹⁹³² 1100 Btu/Δ°F/ton from: West, R.C., M.C. Rodezno, G. Julian, B.D. Prowell, B. Frank, L.V. Osborn, & A.J. Kriech (2014). "NCHRP Report 779:Field Performance of Warm-Mix Asphalt Technologies. Transportation Research Board of the National Academies", Washington, D.C. doi:10.17226/22272, converted to 0.011 Therms/Δ°F/ton by dividing by 100,000 Btu/therm.

4.9.23 Energy Efficient Hand Dryers

DESCRIPTION

This measure consists of installing efficient hand dryers that save energy by drying with air movement, using motion sensors, and reducing drying time. Energy efficient hand dryers use less energy per dry than standard hand dryers. Hand dryers are applicable in retail, commercial, and industrial settings.

This measure was developed to be applicable to the following program types: TOS, ERET. If applied to other program types, the measure savings should be verified.

DEFINITION OF EFFICIENT EQUIPMENT

To qualify for this measure, a hand dryer must be motion operated with rated load of 1,500 W or less.

DEFINITION OF BASELINE EQUIPMENT

The baseline equipment for this measure is a push-button operated hand dryer with connected load in excess of 1,500 Watts.

DEEMED LIFETIME OF EFFICIENT EQUIPMENT

The measure life for a new energy efficient hand dryer is 10 years¹⁹³³.

DEEMED MEASURE COST¹⁹³⁴

Incremental cost is \$483. Baseline cost for a hand dryer is \$368. Efficient cost for an efficient hand dryer is \$851.

LOADSHAPE

Loadshape C02 - Commercial Electric DHW

COINCIDENCE FACTOR

Formula of Coincidence Factor is as follows:

$$CF = \frac{\text{Cycle Time per Use} * \text{Use per Day} * \text{Site Occupied Days per Year}}{\text{Site Occupied Hours per Day} * 365}$$

¹⁹³³ Based on studies conducted by two separate parties; Comparative Environmental Life Cycle Assessment of Hand Drying Systems by Quantis (pg 2) and Guidelines to Reduce/Eliminate Paper Towel Use by Installing Electric Hand Dryers by Partners in Pollution Prevention P3 (pg 17).

¹⁹³⁴ Cost is the average retail costs for 16 baseline and 10 efficient hand dryers. See *Hand_Dryer_Analysis.xlsx*. Cost source: RestroomDirect.com

Where:

Usage	Example Building Types	Cycles per Day ¹⁹³⁵	Occupied Days per Year (DPY) ¹⁹³⁶	Occupied Hours per Day ¹⁹³⁷	Coincidence Factor (CF)
Low	Office, Warehouse	50	250	8	0.04
Moderate	Restaurant, Small Grocery, Small Retail	125	365	15	0.09
High – <12 hr/day	K-12 School, University, Theater, Conference Center	250	200	9	0.16
High – >=12 hr/day	Large Grocery, Retail Department Store	375	365	13	0.29
Heavy - Intermittent	Stadium, Theater, Place of Worship	250	80	6	0.10
Heavy Duty - 24/7	Transportation Center, Airport	750	365	23	0.34

Algorithm

CALCULATION OF ENERGY SAVINGS

ELECTRIC ENERGY SAVINGS

$$\Delta kWh = CPD * DPY * \frac{(Watts_{Base} * CycleTime_{Base} - Watts_{EE} * CycleTime_{EE})}{(3600 \frac{sec}{hr} * 1000 \frac{Watts}{kW})}$$

Where:

- CPD = Number of cycles per day.
= If not known, use assumption as defined in Coincidence Factor section.
- DPY = Number of days the facility operates per year.
= If not known, use assumption as defined in Coincidence Factor section.
- Watts = Unit wattage.
= Actual. If not known, use assumption from the table below.

Assumptions	Power (watts)
Baseline ¹⁹³⁸	2,036
Efficient ¹⁹³⁹	1,066

¹⁹³⁵ Guidehouse, Inc. Engineering Estimate, 2022

¹⁹³⁶ Illinois TRM v9.0, Days per year, from 4.3.2 Low Flow Faucet Aerators

¹⁹³⁷ Occupancy based on Lighting HOU from Section 4.5, combined with days per year from Section 4.3.2.

¹⁹³⁸ CLEARResult survey of 24 hand dryers in convenience stores in Arkansas. See Hand_Dryer_Analysis.xlsx.

¹⁹³⁹ CLEARResult cost/specification survey of 10 unique efficient hand dryers. See Hand_Dryer_Analysis.xlsx.

Cycle Time = Runtime seconds per use.
 = Actual. If not known, use assumption from the table below.

Assumptions	Cycle Time (seconds)
Baseline ¹⁹⁴⁰	37
Efficient ¹⁹⁴¹	12

For example, a new efficient hand dryer replacing a baseline hand dryer at a large grocery store, with unknown cycles per day and unknown days per year:

$$\Delta kWh = (375 * 365 * (2,036 * 37 - 1,066 * 12)) / (3600 * 1000)$$

$$= 2378 \text{ kWh}$$

SUMMER COINCIDENT PEAK DEMAND SAVINGS

$$\Delta kW_{Peak} = \frac{(Watts_{Base} - Watts_{EE})}{1000} * CF$$

Where:

- Watts_{Base} = As defined in section above.
- Watts_{EE} = As defined in section above.
- CF = Coincidence Factor as defined in Coincidence Factor section (shown here for convenience):

$$CF = \frac{Cycle\ Time\ per\ Use * Use\ per\ Day * Site\ Occupied\ Days\ per\ Year}{Site\ Occupied\ Hours\ per\ Day * 365}$$

Where:

¹⁹⁴⁰ CLEARresult survey of 24 hand dryers in convenience stores in Arkansas. See *Hand_Dryer_Analysis.xlsx*.

¹⁹⁴¹ CLEARresult cost/specification survey of 10 unique efficient hand dryers. See *Hand_Dryer_Analysis.xlsx*.

Usage	Example Building Types	Cycles per Day ¹⁹⁴²	Occupied Days per Year (DPY) ¹⁹⁴³	Occupied Hours per Day ¹⁹⁴⁴	Coincidence Factor (CF)
Low	Office, Warehouse	50	250	8	0.04
Moderate	Restaurant, Small Grocery, Small Retail	125	365	15	0.09
High – <12 hr/day	K-12 School, University, Theater, Conference Center	250	200	9	0.16
High – >=12 hr/day	Large Grocery, Retail Department Store	375	365	13	0.29
Heavy - Intermittent	Stadium, Theater, Place of Worship	250	80	6	0.10
Heavy Duty - 24/7	Transportation Center, Airport	750	365	23	0.34

For example, a new efficient hand dryer replacing a baseline hand dryer at a large grocery store, with unknown cycles per day and unknown days per year:

$$\begin{aligned} \Delta kW &= ((2,036 - 1,066)/1000)*0.29 \\ &= 0.28 \text{ kW} \end{aligned}$$

FOSSIL FUEL SAVINGS

N/A

WATER AND OTHER NON-ENERGY IMPACT DESCRIPTIONS AND CALCULATION

N/A

DEEMED O&M COST ADJUSTMENT CALCULATION

N/A

MEASURE CODE: CI-MSC-EEHD-V02-230101

REVIEW DEADLINE: 1/1/2026

¹⁹⁴² Guidehouse, Inc. Engineering Estimate, 2022

¹⁹⁴³ Illinois TRM v9.0, Days per year, from 4.3.2 Low Flow Faucet Aerators

¹⁹⁴⁴ Occupancy based on Lighting HOU from Section 4.5, combined with days per year from Section 4.3.2.

4.9.24 Elevator Modernization

DESCRIPTION

This measure covers the upgrade of existing elevators by replacing critical components in order for elevators to be able to handle new technology, have better performance, and to operate more efficiently. Elevator modernization typically includes motor upgrades, elevator drive system upgrades, and elevator controller replacement.

This measure is applicable to the following program types: RF.

DEFINITION OF EFFICIENT EQUIPMENT

This measure is applicable when retrofitting an existing Elevator with a Higher efficiency Motor/ Drive [Silicon Controlled Rectifier (SCR), Pulse Width Modulator (PWD) or variable Voltage variable frequency drive (VVVF)]/ Controller.

Only applicable to Office and Multifamily buildings (e.g.- small offices, large offices, low-rise multifamily, High-rise multifamily)

DEFINITION OF BASELINE EQUIPMENT

The baseline is existing elevator systems with lower efficiency Motor/ Drive [only listed drive system applicable: Motor-Generator (M-G) set system, Silicon Controlled Rectifier (SCR) and Pulse Width Modulator (PWD)]/ Controller.

DEEMED LIFETIME OF EFFICIENT EQUIPMENT

The expected lifetime of the measure is 15 years.¹⁹⁴⁵

DEEMED MEASURE COST

Costs are highly specific to each installation, as so the actual Equipment and Labor costs should be used.

LOADSHAPE

N/A

COINCIDENCE FACTOR

The coincidence factor for this measure is 1.0. Applying average load factor at peak is a conservative approach for estimating summer peak demand savings.¹⁹⁴⁶

Algorithm

CALCULATION OF ENERGY SAVINGS

Only the following control upgrade configurations are applicable to this measure

Acceptable Elevator Drive Replacement Configuration

Baseline Condition	Compliance Condition
(M-G) Set	SCR, PWM, VVVF drives
SCR drive	PWM, VVVF drive
PWM drive	VVVF drive

¹⁹⁴⁵ New York Standard Approach for Estimating Energy Savings from Energy Efficiency Programs V11- End of Useful life, https://dps.ny.gov/system/files/documents/2023/12/nys-trm-v11_filing.pdf

¹⁹⁴⁶ New York Standard Approach for Estimating Energy Savings from Energy Efficiency Programs V11- ELEVATOR MODERNIZATION.

Methods for calculating savings for M-G set baseline systems are presented below separate from SCR or PWM drive baseline systems in order to differentiate the baseline efficiency term as described in the Baseline Efficiency section below, but also to account for AC motor idling energy consumption present in an M-G set drive. There is no idling motor present in PWM or SCR drive systems, and thus no savings associated with idle energy is claimed in those cases.

ELECTRIC ENERGY SAVINGS

Motor-Generator set (M-G) as baseline system:

$$\Delta kWh = units \times [\Delta kWh_{baseline} - \Delta kWh_{ee} + (RegenSF \times \Delta kWh_{regen})]$$

$$\Delta kWh_{baseline} = \left[\frac{lb_{baseline} \times (1 - OCW_{baseline}) \times (ft/min)_{baseline}}{33,000 \times Eff_{hoist}} \times \frac{1}{Eff_{baseline}} \times 0.746 \times LF_{avg} \times hrs \right] + \left[\frac{hp \times 0.746 \times LF_{motor, idle}}{Eff_{baseline}} \times (8,760 - hrs) \times F_{idle} \right]$$

$$\Delta kWh_{ee} = \frac{lb_{ee} \times (1 - OCW_{ee}) \times (ft/min)_{ee}}{33,000 \times Eff_{hoist}} \times \frac{1}{Eff_{ee}} \times 0.746 \times LF_{avg} \times hrs$$

$$\Delta kWh_{regen} = \frac{lb_{ee} \times (1 - OCW_{ee}) \times (ft/min)_{ee} \times 0.746 \times Eff_{ee}}{33,000} \times Eff_{regen} \times F_{regen} \times hrs$$

SCR drive or PWM drive as baseline system:

$$\Delta kWh = units \times [\Delta kWh_{baseline} - \Delta kWh_{ee} + (RegenSF \times \Delta kWh_{regen})]$$

$$\Delta kWh_{baseline} = \frac{lb_{baseline} \times (1 - OCW_{baseline}) \times (ft/min)_{baseline}}{33,000 \times Eff_{hoist}} \times \frac{1}{Eff_{baseline}} \times 0.746 \times LF_{avg} \times hrs$$

$$\Delta kWh_{ee} = \frac{lb_{ee} \times (1 - OCW_{ee}) \times (ft/min)_{ee}}{33,000 \times Eff_{hoist}} \times \frac{1}{Eff_{ee}} \times 0.746 \times LF_{avg} \times hrs$$

$$\Delta kWh_{regen} = \frac{lb_{ee} \times (1 - OCW_{ee}) \times (ft/min)_{ee} \times 0.746 \times Eff_{ee}}{33,000} \times Eff_{regen} \times F_{regen} \times hrs$$

where:

- ΔkWh = Annual electric energy savings
- units = Number of units upgraded under the program
- $Eff_{baseline}$ = Baseline equipment’s combined Efficiency. The baseline condition is an existing M-G set, SCR drive, or PWM drive elevator system. The efficiency of the baseline elevator drive systems is derived as follows:

$$Eff_{baseline} = Eff_{motor, baseline} \times Eff_{gear, baseline} \times Eff_{drive, baseline}$$
- $Eff_{motor, baseline}$ = Baseline motor efficiency (NEMA premium efficiency¹⁹⁴⁷)
- $Eff_{drive, baseline}$ = Baseline drive efficiency, use actual if unknown use the values from Table below

Drive type	Efficiency ¹⁹⁴⁸
SCR 6	0.85
SCR12	0.90
PWM	0.94

¹⁹⁴⁷ Elevator Door Lock Monitoring & Energy Code Compliance presentation; Pg-19; https://www.nyc.gov/assets/buildings/pdf/Elevators_DLM_Energy_Code_Compliance.pdf, NY code Currently uses IE2 efficiency as code requirement.

¹⁹⁴⁸ Ibid, V11- ELEVATOR MODERNIZATION.

- $Eff_{gear, baseline}$ = Baseline Gear efficiency, if the existing is Geared use 0.85 if not use 1.¹⁹⁴⁹
- Eff_{ee} = efficiency equipment’s combined Efficiency. The compliance condition may be either Silicon-Controlled Rectifier (SCR) drive, Pulse Width Modulation (PWM) drive or Variable Voltage Variable Frequency (VVVF), Check the Calculation of energy savings section for acceptable replacement configuration.

$$Eff_{ee} = Eff_{motor, ee} \times Eff_{gear, ee} \times Eff_{drive, ee}$$

- $Eff_{motor, ee}$ = New motor efficiency, use actual
- $Eff_{drive, ee}$ = New drive efficiency, use actual if unknown use the values from Table below

Drive type	Efficiency ¹⁹⁵⁰
SCR 6	0.85
SCR12	0.90
PWM	0.94
VVVF	0.95

- $Eff_{Gear, ee}$ = New Gear efficiency, if the existing is Geared use 0.85 if not 1.¹⁹⁵¹
- Eff_{regen} = regenerative efficiency, if unknown use 0.5.¹⁹⁵²
- Eff_{hoist} = hoist system efficiency, if unknown use 0.90.¹⁹⁵³
- RegenSF = Savings Factor for regenerative braking system. If Regenerative Breaking used 1 if not use 0.
- $lbs_{baseline}$ = Baseline Car capacity.
- lbs_{ee} = New Car capacity.
- $OCW_{baseline}$ = Overweight of counterbalance as a fraction of car capacity. If unknown use 0.50.¹⁹⁵⁴
- OCW_{ee} = Overweight of counterbalance as a fraction of car capacity. If unknown use 0.50.¹⁹⁵⁵
- ft/min = Rated top velocity of car, in ft/min
- LF_{avg} = Average load factor. If unknown use 0.35.¹⁹⁵⁶
- hrs = Annual hours of elevator operation. If unknown use 2,750.¹⁹⁵⁷
- hp = Horsepower of M-G set motor
- $LF_{motor, idle}$ = M-G set motor load factor in idling mode, 0.11¹⁹⁵⁸

¹⁹⁴⁹ Ibid, V11- ELEVATOR MODERNIZATION.

¹⁹⁵⁰ Ibid, V11- ELEVATOR MODERNIZATION.

¹⁹⁵¹ Ibid, V11- ELEVATOR MODERNIZATION.

¹⁹⁵² Ibid, V11- ELEVATOR MODERNIZATION

¹⁹⁵³ Ibid, V11- ELEVATOR MODERNIZATION

¹⁹⁵⁴ The Vertical Transportation Handbook, 4th Edition, by George R. Strakosch and Robert S. Caporale, pg. 213.

¹⁹⁵⁵ Ibid, pg. 213.

¹⁹⁵⁶ ISO 25745-2:2015: Energy Performance of Lifts, Escalators and Moving Walks -- Part 2: Energy Calculation and Classification for Lifts (elevators).

¹⁹⁵⁷ The Vertical Transportation Handbook, 4th Edition, by George R. Strakosch and Robert S. Caporale, Table 4.2, Table 4.3, Chart 4.2

¹⁹⁵⁸ Ibid, V11- ELEVATOR MODERNIZATION.

F_{idle} = Idling factor; used to account for fraction of run hours M-G set system in idling mode. Use the table below.

Description	Idling factor ¹⁹⁵⁹
Timer incorporated	0.7
No Timer	1
Unknown	0.7

F_{regen} = Regenerative braking factor; used account for fraction of run hours regenerative braking produces energy savings. If unknown use 0.5¹⁹⁶⁰ (Regenerative braking eliminates excess heat and supplies electric energy to the building 50% of run time: when lightly loaded car is raised, when fully loaded car is lowered, whenever the car decelerates).

0.746 = Conversion factor (kW/hp) 0.746 kW equals one electric horsepower

8,760 = Annual hours

33,000 = Conversion factor ((ft-lb/min)/hp), 33,000 foot-pounds per minute equals one electric horsepower.

SUMMER COINCIDENT PEAK DEMAND SAVINGS

Motor-Generator set (M-G) as baseline system-

$$\Delta kW = \text{Unit} \times \left\{ \frac{hp \times 0.746 \times LF_{motor,run}}{Eff_{baseline}} - \frac{lb_{ee} \times (1 - OCW_{ee}) \times (ft/min)_{ee} \times 0.746 \times LF_{peak}}{33,000 \times Eff_{hoist} \times Eff_{ee}} \right\} * CF$$

With SCR drive or PWM drive as baseline system-

$$\Delta kW = \text{Unit} \times \left\{ \left[\frac{lb_{baseline} \times (1 - OCW_{baseline}) \times (ft/min)_{baseline}}{Eff_{baseline}} - \frac{lb_{ee} \times (1 - OCW_{ee}) \times (ft/min)_{ee}}{Eff_{ee}} \right] \times \frac{0.746 \times LF_{peak}}{33,000 \times Eff_{hoist}} \right\} * CF$$

Where:

$LF_{motor,run}$ = M-G set motor load factor when loaded
= 0.9.¹⁹⁶¹

LF_{peak} = Peak load factor
= 0.75.¹⁹⁶²

CF = Summer coincident factor
= 1.0

FOSSIL FUEL SAVINGS

N/A

WATER AND OTHER NON-ENERGY IMPACT DESCRIPTIONS AND CALCULATION

N/A

DEEMED O&M COST ADJUSTMENT CALCULATION

N/A

¹⁹⁵⁹ Ibid, V11- ELEVATOR MODERNIZATION.

¹⁹⁶⁰ Baldor Motors and Drives, Elevator Application Guide, pg. 3-6.

¹⁹⁶¹ Ibid, V11- ELEVATOR MODERNIZATION.

¹⁹⁶² ISO 25745-2:2015: Energy Performance of Lifts, Escalators and Moving Walks -- Part 2: Energy Calculation and Classification for Lifts (elevators). Coincidence factor is embedded within the peak load factor.

MEASURE CODE: CI-MSC-EVMD-V01-250101

REVIEW DEADLINE: 1/1/2029

2025 Illinois Statewide Technical Reference Manual for Energy Efficiency

Version 13.0

Volume 3: Residential Measures

FINAL

September 20, 2024

Effective:

January 1, 2025

[INTENTIONALLY LEFT BLANK]

VOLUME 1: OVERVIEW AND USER GUIDE

VOLUME 2: COMMERCIAL AND INDUSTRIAL MEASURES

5. VOLUME 3: RESIDENTIAL MEASURES 6

5.1 Appliances End Use 6

5.1.1 ENERGY STAR AIR PURIFIER/CLEANER.....6

5.1.2 ENERGY STAR CLOTHES WASHERS.....10

5.1.3 ENERGY STAR DEHUMIDIFIER19

5.1.4 ENERGY STAR DISHWASHER24

5.1.5 ENERGY STAR FREEZER30

5.1.6 ENERGY STAR, CEE TIER 2 OR CEE TIER 3 REFRIGERATOR34

5.1.7 ENERGY STAR AND CEE TIER 2 ROOM AIR CONDITIONER40

5.1.8 REFRIGERATOR AND FREEZER RECYCLING.....47

5.1.9 ROOM AIR CONDITIONER RECYCLING52

5.1.10 ENERGY STAR CLOTHES DRYER55

5.1.11 ENERGY STAR WATER COOLERS62

5.1.12 OZONE LAUNDRY.....64

5.1.13 INCOME QUALIFIED: ENERGY STAR AND CEE TIER 2 ROOM AIR CONDITIONER - RETIRED 12/31/2014.....70

5.1.14 RESIDENTIAL INDUCTION COOKING APPLIANCES71

5.1.15 RESIDENTIAL BOLT-ON SMART DRYER SENSOR.....79

5.1.16 ELECTRIC LAWN AND GARDEN EQUIPMENT83

5.1.17 ENERGY STAR ALL-IN-ONE CLOTHES WASHER-DRYER87

5.2 Consumer Electronics End Use 98

5.2.1 ADVANCED POWER STRIP – TIER 198

5.2.2 TIER 2 ADVANCED POWER STRIPS (APS) – RESIDENTIAL AUDIO VISUAL.....103

5.2.3 ENERGY STAR TELEVISION.....107

5.2.4 SMART SOCKETS.....109

5.3 HVAC End Use..... 113

5.3.1 AIR SOURCE HEAT PUMPS (CENTRALLY DUCTED, DUCTLESS AND PORTABLE)113

5.3.2 BOILER PIPE INSULATION.....135

5.3.3 CENTRAL AIR CONDITIONING139

5.3.4 DUCT INSULATION AND SEALING.....149

5.3.5 FURNACE BLOWER MOTOR165

5.3.6 GAS HIGH EFFICIENCY BOILER170

5.3.7 GAS HIGH EFFICIENCY FURNACE174

5.3.8	GROUND SOURCE HEAT PUMP.....	179
5.3.9	HIGH EFFICIENCY BATHROOM EXHAUST OR RADON MITIGATION FAN.....	194
5.3.10	HVAC TUNE UP (CENTRAL AIR CONDITIONING OR AIR SOURCE HEAT PUMP).....	197
5.3.11	PROGRAMMABLE THERMOSTATS	201
5.3.12	DUCTLESS HEAT PUMPS – REMOVED IN v12	206
5.3.13	RESIDENTIAL FURNACE TUNE-UP.....	207
5.3.14	BOILER RESET CONTROLS	210
5.3.15	ENERGY STAR CEILING FAN	213
5.3.16	ADVANCED THERMOSTATS	217
5.3.17	GAS HIGH EFFICIENCY COMBINATION BOILER	226
5.3.18	FURNACE FILTER ALARM – PROVISIONAL MEASURE	231
5.3.19	THERMOSTATIC RADIATOR VALVES – PROVISIONAL MEASURE.....	232
5.3.20	RESIDENTIAL ENERGY RECOVERY VENTILATOR (ERV).....	235
5.3.21	AIR HANDLER FILTER CLEANING/REPLACEMENT	245
5.3.22	HIGH EFFICIENCY KITCHEN EXHAUST FANS	249
5.4	Hot Water End Use.....	251
5.4.1	DOMESTIC HOT WATER PIPE INSULATION	251
5.4.2	GAS WATER HEATER.....	258
5.4.3	HEAT PUMP WATER HEATERS.....	263
5.4.4	LOW FLOW FAUCET AERATORS	273
5.4.5	LOW FLOW SHOWERHEADS	283
5.4.6	WATER HEATER TEMPERATURE SETBACK	291
5.4.7	WATER HEATER WRAP	295
5.4.8	THERMOSTATIC RESTRICTOR SHOWER VALVE.....	298
5.4.9	SHOWER TIMER	305
5.4.10	POOL COVERS.....	311
5.4.11	DRAIN WATER HEAT RECOVERY	314
5.4.12	RECIRCULATING PUMP CONTROLS	318
5.4.13	AUTO-DIVERTING TUB SPOUT SYSTEM	324
5.5	Lighting End Use.....	332
5.5.1	COMPACT FLUORESCENT LAMP (CFL)—RETIRED 12/31/2018, REMOVED IN v8	332
5.5.2	ENERGY STAR SPECIALTY COMPACT FLUORESCENT LAMP (CFL)—RETIRED 12/31/2018, REMOVED IN v8.....	332
5.5.3	ENERGY STAR TORCHIERE—RETIRED 12/31/2018, REMOVED IN v8.....	332
5.5.4	EXTERIOR HARDWIRED COMPACT FLUORESCENT LAMP (CFL) FIXTURE—RETIRED 12/31/2018, REMOVED IN v8.....	332

5.5.5	INTERIOR HARDWIRED COMPACT FLUORESCENT LAMP (CFL) FIXTURE—RETIRED 12/31/2018, REMOVED IN V8	332
5.5.6	LED SPECIALTY LAMPS	333
5.5.7	LED EXIT SIGNS	344
5.5.8	LED SCREW BASED OMNIDIRECTIONAL BULBS	349
5.5.9	LED FIXTURES.....	357
5.5.10	HOLIDAY STRING LIGHTING.....	364
5.5.11	LED NIGHTLIGHTS	369
5.5.12	CONNECTED LED LAMPS	374
5.5.13	EISA EXEMPT LED LIGHTING.....	380
5.5.14	ULTRA-EFFICIENT LED LIGHTING	389
5.6	Shell End Use.....	398
5.6.1	AIR SEALING	398
5.6.2	BASEMENT SIDEWALL INSULATION	416
5.6.3	FLOOR INSULATION ABOVE CRAWLSPACE	426
5.6.4	WALL INSULATION	436
5.6.5	CEILING/ATTIC INSULATION	446
5.6.6	RIM/BAND JOIST INSULATION	457
5.6.7	LOW-E STORM WINDOW.....	467
5.6.8	HIGH PERFORMANCE WINDOWS	473
5.6.9	INSULATED CELLULAR SHADES.....	482
5.6.10	MULTIFAMILY WHOLE BUILDING AEROSOL SEALING.....	489
5.6.11	INSULATED CONCRETE FORMS.....	493
5.7	Miscellaneous	504
5.7.1	HIGH EFFICIENCY POOL PUMPS	504
5.7.2	LOW FLOW TOILETS	509
5.7.3	LEVEL 2 ELECTRIC VEHICLE CHARGER.....	512
5.7.4	HEAT PUMP SWIMMING POOL HEATER	515
5.7.5	TREE PLANTING.....	523

VOLUME 4: CROSS-CUTTING MEASURES AND ATTACHMENTS

5. Volume 3: Residential Measures

5.1 Appliances End Use

5.1.1 ENERGY STAR Air Purifier/Cleaner

DESCRIPTION

An air purifier (cleaner) meeting the efficiency specifications of ENERGY STAR Version 2.0 (effective date: October 17, 2020) and ENERGY STAR Most Efficient 2024 criteria (effective date: January 1, 2024) is purchased and installed in place of a model meeting the current federal standard.

This measure was developed to be applicable to the following program types: TOS, NC.

If applied to other program types, the measure savings should be verified.

DEFINITION OF EFFICIENT EQUIPMENT

The efficient equipment is defined as an air purifier meeting the efficiency specifications of ENERGY STAR as provided below.

- Must produce a minimum 30 Clean Air Delivery Rate (CADR) for Smoke¹ to be considered under this specification. Minimum Performance Requirement is expressed in Smoke CADR/Watt and it shall be greater than or equal to the Minimum Smoke CADR/Watt Requirement shown in the table below:

	ENERGY STAR	ENERGY STAR Most Efficient
CADR Range	CADR/W	CADR/W
30 ≤ Smoke CADR < 100	1.90	5.40
100 ≤ Smoke CADR < 150	2.40	6.60
150 ≤ Smoke CADR < 200	2.90	7.60
200 ≤ Smoke CADR	2.90	

- “Partial On Mode” Requirements are to be calculated as per Section 3.4.1 of the Energy Star Eligibility Criteria²
- UL Safety Requirement: Models that emit ozone as a byproduct of air cleaning must meet UL Standard 867 (ozone production must not exceed 50ppb)

DEFINITION OF BASELINE EQUIPMENT

The baseline for this measure is defined as a new air purifier that meets the Code of Federal Regulations appliance federal efficiency standards. As of December 31, 2023, those are as defined below for air cleaners³:

CADR Range	Integrated Energy Factor (PM _{2.5} CADR/W)	
	Tier 1 December 31, 2023	Tier 2 December 31, 2025
10 ≤ PM _{2.5} CADR < 100	1.70	1.90
100 ≤ PM _{2.5} CADR < 150	1.90	2.40
PM _{2.5} CADR ≥ 150	2.00	2.90

¹ Measured according to the latest ANSI/AHAM AC-1 (AC-1) Standard

² ENERGY STAR® Product Specification for Room Air Cleaners - Eligibility Criteria Version 2.0, effective October 17, 2020.

³ DOE Energy Conservation Standards for Air Cleaners, EERE–2021–BT–STD–0035, Federal Register, vol. 88, no.168, August 31, 2023. Effective date of conservation standard: December 31, 2023.

DEEMED LIFETIME OF EFFICIENT EQUIPMENT

The measure life is assumed to be 9 years.⁴

DEEMED MEASURE COST

The incremental cost for this measure is dependent on the Air Purifier size in CADR of Smoke.⁵

Product Size	Minimum CADR/W	Average ENERGY STAR Purchase Cost (\$)	Average Incremental Cost (\$)	
			Non-IQ	IQ ⁶
30 ≤ Smoke CADR < 100	1.9	\$82.49	\$8.44	\$20.78
100 ≤ Smoke CADR < 150	2.4	\$140.43	\$22.33	\$42.01
150 ≤ Smoke CADR < 200	2.9	\$349.00	\$92.34	\$135.12
200 ≤ Smoke CADR	2.9	\$264.49	\$44.50	\$81.17

LOADSHAPE

Loadshape C53 – Flat

Algorithm

CALCULATION OF SAVINGS

ELECTRIC ENERGY SAVINGS

$$\Delta kWh = kWh_base - kWh_eff$$

$$kWh_base = (hours * (SmokeCADR_base / (SmokeCADR_per_watt_base * 1000)) + (8760 - hours) * PartialOnModePower_base / 1000) * IQAdj$$

$$kWh_eff = hours * (SmokeCADR_eff / (SmokeCADR_per_watt_eff * 1000)) + (8760 - hours) * PartialOnModePower_eff / 1000$$

Where:

- kWh_base = Annual Electrical Usage for baseline unit (kWh)
- kWh_eff = Annual Electrical Usage for efficient unit (kWh)
- hours = Annual active operating hours
= 5840⁷
- SmokeCADR_base = Smoke CADR for baseline units, as provided in table below
- SmokeCADR_per_watt_base = Smoke CADR delivery rate per watt for baseline units, as provided in table below
- PartialOnModePower_base = Partial On Model Power for baseline units by category (watts), as provided in table below

⁴ ENERGY STAR Qualified Room Air Cleaner Calculator citing Appliance Magazine, Portrait of the U.S. Appliance Industry 1998.

⁵ ENERGY STAR V2 Room Air Cleaners Data Package (October 11, 2019). See file “ENERGY STAR V2 Room Air Cleaners Data Package_GH 05122020_VEIC.xlsx”

⁶ IQ Incremental costs factor in the assumption that a secondhand unit costs on average 50% of a new baseline unit, and that 1/3 of IQ participants would have purchased a unit on the secondhand market. See “IQ Appliance Calculations.xls” for information.

⁷ Consistent with ENERGY STAR v.2.0 Room Air Cleaners Data Package and analysis. See file: ICF_EPA_AirPurifier_Summary Savings Calculations.xlsx.

- 1000 = Conversion factor from watts to kilowatts
- IQAdj = Baseline consumption adjustment for IQ program participants to account for a portion of participants who would have utilized the secondary market.⁸
= 1.25 if IQ, 1.0 if non-IQ
- SmokeCADR_eff = Smoke CADR for efficient unit
= Actual, if unknown use values provided in table below
- SmokeCADR_per_watt_eff = Smoke CADR delivery rate per watt for efficient units
= Actual, if unknown use values provided in table below
- PartialOnModePower_eff = Partial On Model Power for efficient units by category (watts)
= Actual, if unknown use values provided in table below

Parameter assumptions for units by CADR Range:⁹

CADR Range	Smoke CADR	Smoke CADR per Watt	Partial On Mode Power (watts)	Annual Energy Use (kWh)	
				Non-IQ	IQ
Baseline Units					
30 ≤ Smoke CADR < 100	70.9	1.7	2	249	312
100 ≤ Smoke CADR < 150	129.8	1.9	2	405	506
150 ≤ Smoke CADR < 200	173.2	2.0	2	512	640
200 ≤ Smoke CADR	315.0	2.0	2	926	1157
Efficient Units					
30 ≤ Smoke CADR < 100	70.9	3.42	0.51	123	
100 ≤ Smoke CADR < 150	129.8	4.14	0.52	185	
150 ≤ Smoke CADR < 200	173.2	4.77	0.53	214	
200 ≤ Smoke CADR	315.0	5.13	0.63	361	

CADR Range	Energy Savings ΔkWh	
	Non-IQ	IQ
30 ≤ Smoke CADR < 100	127	189
100 ≤ Smoke CADR < 150	220	322

⁸ It is assumed that a second-hand unit is on average 2/3 of a measure’s EUL years old (6 years). The baseline consumption from the TRM in 2018 was increased by an estimate of 0.4% * 6 years (based on review of the refrigerator/freezer regression algorithm used in the 5.1.8 Refrigerator and Freezer Recycling measure) to account for degradation of performance over time. This secondhand consumption was then weighted 1/3: 2/3 current new baseline to estimate a multiplier for IQ participants. See “IQ Appliance Calculations.xls” for information.

⁹ Baseline values are consistent with ENERGY STAR v.2.0 Room Air Cleaners Data Package and analysis. See file: ICF_EPA_AirPurifier_Summary Savings Calculations.xlsx. Efficient values are averages within each CADR range for all models on the ENERGY STAR Qualified products list (QPL accessed: February 18, 2021). Both Baseline & Efficient Capacities (CADR) are also sourced from the ENERGY STAR QPL. For Final Savings Calcs for this measure please see: IL TRM_AirPurifier_Summary Savings Calculations_06152021.xlsx.

CADR Range	Energy Savings ΔkWh	
	Non-IQ	IQ
150 ≤ Smoke CADR < 200	298	426
200 ≤ Smoke CADR	565	796

SUMMER COINCIDENT PEAK DEMAND SAVINGS

$$\Delta kW = \Delta kWh / \text{Hours} * CF$$

Where:

- ΔkWh = Gross customer annual kWh savings for the measure
- Hours = Average hours of use per year
= 5840 hours¹⁰
- CF = Summer Peak Coincidence Factor for measure
= 66.7%¹¹

CADR Range	ΔkW	
	Non-IQ	IQ
30 ≤ Smoke CADR < 100	0.014	0.022
100 ≤ Smoke CADR < 150	0.025	0.037
150 ≤ Smoke CADR < 200	0.034	0.049
200 ≤ Smoke CADR	0.065	0.091

FOSSIL FUEL SAVINGS

N/A

WATER IMPACT DESCRIPTIONS AND CALCULATION

N/A

DEEMED O&M COST ADJUSTMENT CALCULATION

There are no operation and maintenance cost adjustments for this measure.¹²

MEASURE CODE: RS-APL-ESAP-V07-250101

REVIEW DEADLINE: 1/1/2028

¹⁰ Consistent with ENERGY STAR v.2.0 Room Air Cleaners Data Package and analysis. See file: ICF_EPA_AirPurifier_Summary Savings Calculations.xlsx.

¹¹ Assumes that the purifier usage is evenly spread throughout the year, therefore coincident peak is calculated as 5840/8760 = 66.7%.

¹² Some types of room air cleaners require filter replacement or periodic cleaning, but this is likely to be true for both efficient and baseline units and so no difference in cost is assumed.

5.1.2 ENERGY STAR Clothes Washers

DESCRIPTION

This measure relates to the installation of a clothes washer meeting the ENERGY STAR, ENERGY STAR Most Efficient/CEE Tier 2 or CEE Advanced Tier minimum qualifications. Note if the DHW and dryer fuels of the installations are unknown (for example through a retail program) savings should be based on a weighted blend using RECS data (the resultant values (kWh, therms and gallons of water) are provided). The algorithms can also be used to calculate site specific savings where DHW and dryer fuels are known.

This measure was developed to be applicable to the following program types: TOS, NC.

If applied to other program types, the measure savings should be verified.

DEFINITION OF EFFICIENT EQUIPMENT

Clothes washer must meet the ENERGY STAR, ENERGY STAR Most Efficient/CEE Tier 2 or CEE Advanced Tier minimum qualifications, as required by the program.

DEFINITION OF BASELINE EQUIPMENT

The baseline condition is a standard sized clothes washer meeting the minimum federal baseline as of January 2018.¹³

Efficiency Level	Top Loading >2.5 Cu ft	Front Loading >2.5 Cu ft
Federal Standard	≥1.57 IMEF, ≤6.5 IWF	≥1.84 IMEF, ≤4.7 IWF
ENERGY STAR	≥2.06 IMEF, ≤4.3 IWF	≥2.76 IMEF, ≤3.2 IWF
ENERGY STAR Most Efficient/CEE Tier 2	≥2.92 IMEF, ≤3.2 IWF	
CEE Advanced Tier	≥3.1 IMEF, ≤3.0 IWF	

DEEMED LIFETIME OF EFFICIENT EQUIPMENT

The expected measure life is assumed to be 14 years¹⁴

DEEMED MEASURE COST

The incremental cost for an efficient unit for a non-IQ participant is assumed to be: \$87, for an ENERGY STAR Most Efficient/CEE Tier 2 unit it is \$85 and for a CEE Advanced Tier it is \$99.¹⁵

For an IQ participant the incremental cost is assumed to be: \$214, for an ENERGY STAR Most Efficient/CEE Tier 2 unit it is \$212 and for a CEE Advanced Tier it is \$227.¹⁶

¹³ DOE Energy Conservation Standards for Clothes Washers, Appliance and Equipment Standard, 10 CFR Part 430.32(g)

¹⁴ Based on DOE Life-Cycle Cost and Payback Period Excel-based analytical tool.

¹⁵ Cost estimates are based on analysis of cost data provided in the 2017 Department of Energy Technical Support Document (see IL_TRM_CW Analysis_082022.xlsx). This analysis looked at incremental cost and market data from the CEC Appliance Database and attempts to find the costs associated only with the efficiency improvements. Note that the incremental cost assumes a mix of top and front loading machines available in each efficiency tier. Since CEE T2 and Advanced Tier units are all front loading, and the incremental cost is lower for these machines, the T2 incremental cost is lower than ENERGY STAR which is based on a mix of front and top- loading machines..

¹⁶ IQ Incremental costs factor in the assumption that a secondhand unit costs on average 50% of a new baseline unit, and that 1/3 of IQ participants would have purchased a unit on the secondhand market. See "IQ Appliance Calculations.xls" for information.

DEEMED O&M COST ADJUSTMENTS

N/A

LOADSHAPE

Loadshape R01 - Residential Clothes Washer

COINCIDENCE FACTOR

The coincidence factor for this measure is 3.8%.¹⁷

Algorithm

CALCULATION OF SAVINGS

ELECTRIC ENERGY SAVINGS

1. Calculate clothes washer savings based on the Integrated Modified Energy Factor (IMEF).

The Integrated Modified Energy Factor (IMEF) includes unit operation, standby, water heating, and drying energy use: "IMEF is the quotient of the capacity of the clothes container, C, divided by the total clothes washer energy consumption per cycle, with such energy consumption expressed as the sum of the machine electrical energy consumption, M, the hot water energy consumption, E, the energy required for removal of the remaining moisture in the wash load, D, and the combined low-power mode energy consumption".¹⁸

The hot water and dryer savings calculated here assumes electric DHW and Dryer (this will be separated in Step 2).

$$\text{IMEFsavings}^{19} = \text{Capacity} * (\text{IQAdj}/\text{IMEFbase} - 1/\text{IMEFeff}) * \text{Ncycles}$$

Where

Capacity = Clothes Washer capacity (cubic feet)

= Actual. If capacity is unknown assume 3.55 cubic feet²⁰

IQAdj = Baseline consumption adjustment for IQ program participants to account for a portion of participants who would have utilized the secondary market.²¹

= 1.02 if IQ, 1.0 if non-IQ

IMEFbase = Integrated Modified Energy Factor of baseline unit

¹⁷ Calculated from Itron eShapes, 8760 hourly data by end use for Missouri, as provided by Ameren.

¹⁸ Definition provided on the ENERGY STAR website.

¹⁹ IMEFsavings represents total kWh only when water heating and drying are 100% electric.

²⁰ Based on the average clothes washer volume of all units that pass the new Federal Standard on the California Energy Commission (CEC) database of Clothes Washer products accessed on 04/21/2022. If utilities have specific evaluation results providing a more appropriate assumption for homes in a particular market or geographical area then that should be used.

²¹ It is assumed that a second-hand unit is on average 2/3 of a measure’s EUL years old (9 years). The baseline consumption of a unit meeting the pre 03/2015 Federal Standard was increased by an estimate of 0.4% * 9 years (based on review of the refrigerator/freezer regression algorithm used in the 5.1.8 Refrigerator and Freezer Recycling measure) to account for degradation of performance over time. For 2025 on, the post 03/2015 Federal Standard is utilized. This second hand consumption was then weighted 1/3: 2/3 current new baseline to estimate a multiplier for IQ participants. See “IQ Appliance Calculations.xls” for information.

= 1.71²²

IMEF_{eff} = Integrated Modified Energy Factor of efficient unit
 = Actual. If unknown assume average values provided below.

Ncycles = Number of Cycles per year
 = 276²³

IMEF_{savings} is provided below based on deemed values:²⁴

Efficiency Level	IMEF	IMEF Savings (kWh)
Federal Standard	1.75	0.0
ENERGY STAR	2.21	130.6
ENERGY STAR Most Efficient/CEE Tier 2	2.92	238.4
CEE Advanced Tier	3.10	257.9

2. Break out savings calculated in Step 1 for electric DHW and electric dryer

$$\Delta kWh = [Capacity * IQAdj/IMEF_{base} * Ncycles * (\%CW_{base} + (\%DHW_{base} * \%Electric_DHW) + (\%Dryer_{base} * \%Electric_Dryer))] - [Capacity * 1/IMEF_{eff} * Ncycles * (\%CW_{eff} + (\%DHW_{eff} * \%Electric_DHW) + (\%Dryer_{eff} * \%Electric_Dryer))]$$

Where:

%CW = Percentage of total energy consumption for Clothes Washer operation (different for baseline and efficient unit – see table below)

%DHW = Percentage of total energy consumption used for water heating (different for baseline and efficient unit – see table below)

%Dryer = Percentage of total energy consumption for dryer operation (different for baseline and efficient unit – see table below)

	Percentage of Total Energy Consumption ²⁵		
	%CW	%DHW	%Dryer
Baseline	6.7%	15.8%	77.5%
ENERGY STAR	6.6%	13.0%	80.4%
ENERGY STAR Most	8.2%	8.8%	82.9%

²² Weighted average IMEF of Federal Standard rating for Front Loading and Top Loading units. Weighting is based upon the relative top v front loading percentage of available non-ENERGY STAR product in the CEC database (products accessed on 04/21/2022).

²³ Loads per week was estimated by taking the weighted average of the number of loads per week (midpoint used where loads per week is a range and the weights are the share of respondents falling into each number of loads per week response bin). This estimate was scaled to an IL-specific value by applying a ratio developed using the 2009 state specific values for the states in the East North Central portion of the Midwest Region. This value was then scaled to remain consistent with the volume of laundry completed on average each week between the 2009 RECS data and the new source.

²⁴ IMEF values are the weighted average of the new ENERGY STAR specifications. Weighting is based upon the relative top v front loading percentage of available ENERGY STAR and CEE Tier 2 products in the CEC database. See “IL TRM_CW Analysis_082024.xlsx” for the calculation.

²⁵ The percentage of total energy consumption that is used for the machine, heating the hot water or by the dryer is different depending on the efficiency of the unit. Values are based on a weighted average of top-loading and front-loading units based on data from the 2017 DOE Life-Cycle Cost and Payback Period Excel-based analytical tool. See “IL TRM_CW Analysis_082024.xlsx” for the calculation.

	Percentage of Total Energy Consumption ²⁵		
	%CW	%DHW	%Dryer
Efficient/CEE Tier 2			
CEE Advanced Tier	8.9%	7.0%	84.1%

%Electric_DHW = Percentage of DHW savings assumed to be electric
 = 100 % for Electric
 = 0 % for Fossil Fuel
 = If unknown²⁶, use the following table:

Utility	Location				Unknown
	Single Family	Single Family Low Income	Multi Family	Multi Family Low Income	
Ameren ²⁷	24%	25%	40%	43%	28%
ComEd ²⁸	8%		11%		9%
People’s Gas ²⁹	2.0%	2.0%	1.7%	2.1%	2.0%
Northshore Gas ³⁰	1.3%	1.8%	10.0%	2.4%	2.3%
Nicor Gas ³¹	1.3%	1.8%	10.0%	2.4%	2.3%
All DUs³²					25%

Note: If a measure is supported by a gas and electric utility through a joint program, and it is unknown whether the participant has a gas supply, the electric utility values in the table above should be used. If it is known that the participant has a gas supply, the values from the gas utility above should be applied.

%Electric_Dryer = Percentage of dryer savings assumed to be electric

Dryer fuel	%Electric_Dryer
Electric	100%
Natural Gas	0%
Unknown	69% ³³

Using the default/unknown assumptions provided above, the prescriptive savings for each configuration are presented below:

²⁶ Based on the average % electricity used for water heating in Unknown residential structure types across all utilities covered by the IL program. Residence types include: SF, SF LI, MF & MF LI. Utilities included: Ameren, ComEd, People’s Gas, Northshore Gas & Nicor. Please see subsequent table and citations for specific sources.

²⁷ Provided by AEG from the 2020 Market Potential Study completed for AIC, as well as AIC Income Qualified Initiative: 2021 Participant Survey Results Memo (February 1, 2022) p. 17.

²⁸ Commonwealth Edison Residential Baseline Study (2020). p.4.4 & 4.19; Section 4-7 Water Heating. Prepared by Itron.

²⁹ Implementation Contractors data from Peoples Gas and North Shore Gas for PY2022-2023.

³⁰ Ibid.

³¹ Comparable service area & customers to NSG, therefore using their survey data.

³² For the weighted average calculations, please see the Analysis file. PGL, NSG, Nicor & gas customers were assumed to follow the provided split. ComEd total customers, minus overlap with PGL,NSG & Nicor, therefore electric only homes. Ameren is total customers minus Nicor.

³³ Based on Applied Energy Group, 2016 ‘Ameren Illinois Demand Side Management Market Potential Study: Volume 4 – APPENDICES’.

	ΔkWh – Non IQ Participants								
	Electric DHW Electric Dryer	Gas DHW Electric Dryer	Electric DHW Gas Dryer	Gas DHW Gas Dryer	Electric DHW Unknown Dryer	Gas DHW Unknown Dryer	Unknown DHW Electric Dryer	Unknown DHW Gas Dryer	Unknown DHW Unknown Dryer
ENERGY STAR	130.6	97.6	42.4	9.4	103.2	70.3	105.8	17.7	78.5
ENERGY STAR Most Efficient/CEE Tier 2	238.4	177.2	72.1	11.0	186.8	125.7	192.5	26.3	141.0
CEE Advanced Tier	257.9	189.2	79.0	10.4	197.2	144.6	218.4	22.8	157.7

	ΔkWh –IQ Participants								
	Electric DHW Electric Dryer	Gas DHW Electric Dryer	Electric DHW Gas Dryer	Gas DHW Gas Dryer	Electric DHW Unknown Dryer	Gas DHW Unknown Dryer	Unknown DHW Electric Dryer	Unknown DHW Gas Dryer	Unknown DHW Unknown Dryer
ENERGY STAR	143.4	107.2	46.5	10.3	113.3	77.1	116.2	19.4	86.2
ENERGY STAR Most Efficient/CEE Tier 2	251.1	186.7	76.0	11.6	196.8	132.4	202.8	27.7	148.5
CEE Advanced Tier	270.6	198.6	82.9	10.9	207.0	151.7	229.2	23.9	165.5

Secondary kWh Savings for Water Supply and Wastewater Treatment

The following savings should be included in the total savings for this measure but should not be included in TRC tests to avoid double counting the economic benefit of water savings.

$$\Delta kWh_{water} = \Delta Water \text{ (gallons)} / 1,000,000 * E_{water \text{ total}}$$

Where

$$\Delta Water \text{ (gallons)} = \text{Water saved, in gallons – as calculated below.}$$

$$E_{water \text{ total}} = \text{IL Total Water Energy Factor (kWh/Million Gallons)} \\ = 5,010^{34}$$

Using defaults provided:

ENERGY STAR	$\Delta kWh_{water} = 1,595 / 1,000,000 * 5,010$ = 8.0 kWh [8.5 kWh for IQ]
ENERGY STAR Most Efficient/CEE Tier 2	$\Delta kWh_{water} = 2,500 / 1,000,000 * 5,010$ = 12.5 kWh [13.1 kWh for IQ]
CEE Advanced Tier	$\Delta kWh_{water} = 2,709 / 1,000,000 * 5,010$ = 13.6 kWh [14.2 kWh for IQ]

³⁴ This factor includes 2571 kWh/MG for water supply based on Illinois energy intensity data from a 2012 ISAWWA study and 2439 kWh/MG for wastewater treatment based on national energy intensity use estimates. For more information please review Elevate Energy’s ‘IL TRM: Energy per Gallon Factor, May 2018 paper’.

SUMMER COINCIDENT PEAK DEMAND SAVINGS

$$\Delta kW = \Delta kWh/Hours * CF$$

Where:

ΔkWh = Energy Savings as calculated above. Note do not include the secondary savings in this calculation.

Hours = Assumed Run hours of Clothes Washer
= 276 hours³⁵

CF = Summer Peak Coincidence Factor for measure.
= 0.038³⁶

Using the default assumptions provided above, the prescriptive savings for each configuration are presented below:

ΔkW- Non IQ Participants									
	Electric DHW Electric Dryer	Gas DHW Electric Dryer	Electric DHW Gas Dryer	Gas DHW Gas Dryer	Electric DHW Unknown Dryer	Gas DHW Unknown Dryer	Unknown DHW Electric Dryer	Unknown DHW Gas Dryer	Unknown DHW Unknown Dryer
ENERGY STAR	0.0180	0.0134	0.0058	0.0013	0.0142	0.0097	0.0146	0.0024	0.0108
ENERGY STAR Most Efficient/CEE Tier 3	0.0328	0.0244	0.0099	0.0015	0.0257	0.0173	0.0265	0.0036	0.0194
CEE Advanced Tier	0.0355	0.0261	0.0109	0.0014	0.0272	0.0199	0.0301	0.0031	0.0217

ΔkW- IQ Participants									
	Electric DHW Electric Dryer	Gas DHW Electric Dryer	Electric DHW Gas Dryer	Gas DHW Gas Dryer	Electric DHW Unknown Dryer	Gas DHW Unknown Dryer	Unknown DHW Electric Dryer	Unknown DHW Gas Dryer	Unknown DHW Unknown Dryer
ENERGY STAR	0.0197	0.0148	0.0064	0.0014	0.0156	0.0106	0.0160	0.0027	0.0119
ENERGY STAR Most Efficient/CEE Tier 3	0.0346	0.0257	0.0105	0.0016	0.0271	0.0182	0.0279	0.0038	0.0204
CEE Advanced Tier	0.0373	0.0273	0.0114	0.0015	0.0285	0.0209	0.0316	0.0033	0.0228

FOSSIL FUEL SAVINGS

Break out savings calculated in Step 1 of electric energy savings (MEF savings) and extract Natural Gas DHW and Natural Gas dryer savings from total savings:

$$\Delta Therm = [((Capacity * IQAdj/IMEFbase * Ncycles * ((\%DHWbase * \%Fossil_DHW * R_eff) + (\%Dryerbase * \%Gas_Dryer))) - (Capacity * 1/IMEFeff * Ncycles * ((\%DHWeff * \%Fossil_DHW * R_eff) + (\%Dryereff * \%Gas_Dryer))))] * Therm_convert$$

Where:

³⁵ Based on a weighted average of 276 clothes washer cycles per year assuming an average load runs for one hour (Loads per week was estimated by taking the weighted average of the number of loads per week (midpoint used where loads per week is a range and the weights are the share of respondents falling into each number of loads per week response bin). This estimate was scaled to an IL-specific value by applying a ratio developed using the 2009 state specific values for the states in the East North Central portion of the Midwest Region. This value was then scaled to remain consistent with the volume of laundry completed on average each week between the 2009 RECS data and the new source.)

³⁶ Calculated from Itron eShapes, 8760 hourly data by end use for Missouri, as provided by Ameren.

Therm_convert = Conversion factor from kWh to Therm
 = 0.03412

R_eff = Recovery efficiency factor
 = 1.26³⁷

%Fossil_DHW = Percentage of DHW savings assumed to be Fossil Fuel
 = 100 % for Fossil fuel
 = 0 % for Electric
 = If unknown³⁸, use the following table:

Utility	Location				
	Single Family	Single Family Low Income	Multi Family	Multi Family Low Income	Unknown
Ameren ³⁹	76%	75%	60%	57%	72%
ComEd ⁴⁰	92%		89%		91%
People’s Gas ⁴¹	97.9%	98.0%	98.3%	97.6%	97.8%
Northshore Gas ⁴²	98.5%	98.2%	90.0%	97.6%	97.6%
Nicor Gas ⁴³	98.5%	98.2%	90.0%	97.6%	97.6%
All DUs⁴⁴					75%

Note: If a measure is supported by a gas and electric utility through a joint program, and it is unknown whether the participant has a gas supply, the electric utility values in the table above should be used. If it is known that the participant has a gas supply, the values from the gas utility above should be applied.

%Fossil_Dryer = Percentage of dryer savings assumed to be fossil fuel

Dryer fuel	%Gas_Dryer
Electric	0%
Fossil Fuel	100%
Unknown	31% ⁴⁵

³⁷ To account for the different efficiency of electric and Natural Gas hot water heaters (gas water heater: recovery efficiencies ranging from 0.74 to 0.85 (0.78 used), and electric water heater with 0.98 recovery efficiency (see ENERGY STAR Waste Water Recovery Guidelines). Therefore, a factor of 0.98/0.78 (1.26) is applied.

³⁸ Based on the average % electricity used for water heating in Unknown residential structure types across all utilities covered by the IL program. Residence types include: SF, SF LI, MF & MF LI. Utilities included: Ameren, ComEd, People’s Gas, Northshore Gas & Nicor. Please see subsequent table and citations for specific sources.

³⁹ Provided by AEG from the 2020 Market Potential Study completed for AIC, as well as AIC Income Qualified Initiative: 2021 Participant Survey Results Memo (February 1, 2022) p. 17.

⁴⁰ Commonwealth Edison Residential Baseline Study (2020). p.4.4 & 4.19; Section 4-7 Water Heating. Prepared by Itron.

⁴¹ Residential Appliance Saturation Survey of natural gas for space heating and water heating (2021). Note, Multifamily customers have a residential billing rate code and responded on the survey that they live in an apartment or condominium in a building that has either 2-4 or 5+ units.

⁴² Ibid.

⁴³ Comparable service area & customers to NSG, therefore using their survey data.

⁴⁴ For the weighted average calculations, please see the Analysis file. PGL, NSG, Nicor & gas customers were assumed to follow the provided split. ComEd total customers, minus overlap with PGL,NSG & Nicor, therefore gas only homes. Ameren is total customers minus Nicor.

⁴⁵ Based on Applied Energy Group, 2016 'Ameren Illinois Demand Side Management Market Potential Study: Volume 4 – APPENDICES'.

Other factors as defined above.

Using the default/unknown assumptions provided above, the prescriptive savings for each configuration are presented below:

	ΔTherms – Non IQ Participants								
	Electric DHW Electric Dryer	Gas DHW Electric Dryer	Electric DHW Gas Dryer	Gas DHW Gas Dryer	Electric DHW Unknown Dryer	Gas DHW Unknown Dryer	Unknown DHW Electric Dryer	Unknown DHW Gas Dryer	Unknown DHW Unknown Dryer
ENERGY STAR	0.0	1.4	3.0	4.4	0.9	2.4	1.1	4.1	2.0
ENERGY STAR Most Efficient/CEE Tier 2	0.0	2.6	5.7	8.3	4.4	4.4	2.0	7.6	3.7
CEE Advanced Tier	0.0	3.0	6.1	9.1	4.3	4.3	1.7	8.4	3.8

	ΔTherms – IQ Participants								
	Electric DHW Electric Dryer	Gas DHW Electric Dryer	Electric DHW Gas Dryer	Gas DHW Gas Dryer	Electric DHW Unknown Dryer	Gas DHW Unknown Dryer	Unknown DHW Electric Dryer	Unknown DHW Gas Dryer	Unknown DHW Unknown Dryer
ENERGY STAR	0	1.6	3.3	4.9	1.0	2.6	1.2	4.5	2.2
ENERGY STAR Most Efficient/CEE Tier 2	0	2.8	6.0	8.7	4.6	4.6	2.1	8.1	3.9
CEE Advanced Tier	0	3.1	6.4	9.5	4.5	4.5	1.8	8.8	4.0

WATER IMPACT DESCRIPTIONS AND CALCULATION

$$\Delta\text{Water (gallons)} = \text{Capacity} * ((\text{IWFbase} * \text{IQAdj}_{\text{Water}}) - \text{IWFeff}) * \text{Ncycles}$$

Where

ΔWater (gallons) = Water saved, in gallons

IWFbase = Integrated Water Factor of baseline clothes washer
= 5.59⁴⁶

IQAdj_{Water} = Baseline water consumption adjustment for IQ program participants to account for a portion of participants who would have utilized the secondary market.⁴⁷
= 1.02, 1.0 if non-IQ

IWFeff = Water Factor of efficient clothes washer
= Actual. If unknown assume average values provided below.

Using the default assumptions provided above, the prescriptive water savings for each efficiency level are presented below:

⁴⁶ Weighted average IWF of Federal Standard rating for Front Loading and Top Loading units. Weighting is based upon the relative top v front loading percentage of available non-ENERGY STAR product in the CEC database (products accessed on 04/21/2022).

⁴⁷ It is assumed that a second-hand unit is on average 2/3 of a measure’s EUL years old (9 years). The baseline consumption from the TRM in 2015 is assumed the second hand water consumption (note we do not assume a degradation over time for water consumption) was then weighted 1/3: 2/3 current new baseline to estimate a multiplier for IQ participants. See “IQ Appliance Calculations.xls” for information.

Efficiency Level	IWF	ΔWater (gallons per year)	
		Non-IQ	IQ
Federal Standard	5.59	N/A	N/A
ENERGY STAR	4.07	1,492	1,596
ENERGY STAR Most Efficient/CEE Tier 2	3.2	2,339	2,448
CEE Advanced Tier	3	2,535	2,644

DEEMED O&M COST ADJUSTMENT CALCULATION

N/A

MEASURE CODE: RS-APL-ESCL-V13-250101

REVIEW DEADLINE: 1/1/2029

5.1.3 ENERGY STAR Dehumidifier

DESCRIPTION

A dehumidifier meeting the minimum qualifying efficiency standard established by the current ENERGY STAR Version 5.0 (effective 10/31/2019) and ENERGY STAR Most Efficient 2024 Criteria (effective 01/01/2024) is purchased and installed in a residential setting in place of a unit that meets the minimum federal standard efficiency.

This measure was developed to be applicable to the following program types: TOS, NC. If applied to other program types, the measure savings should be verified.

DEFINITION OF EFFICIENT EQUIPMENT

To qualify for this measure, the new dehumidifier must meet the ENERGY STAR standards as defined below:

Equipment Specification	Product Capacity	ENERGY STAR Criteria	ENERGY STAR Most Efficient Criteria
	(Pints/Day)	(L/kWh)	(L/kWh)
Portable Dehumidifier	≤ 25	≥1.57	≥1.70
	>25 and ≤ 50	≥1.80	≥1.90
	>50 and < 155	≥3.30	≥3.40
Whole Home Dehumidifier	Product Case Volume	ENERGY STAR Criteria	ENERGY STAR Most Efficient Criteria
	≤ 8.0	≥ 2.09	≥2.22
	> 8.0	≥ 3.30	≥3.81

Qualifying units shall be equipped with an adjustable humidistat control or shall require a remote humidistat control to operate.

DEFINITION OF BASELINE EQUIPMENT

The baseline for this measure is defined as a new dehumidifier that meets the Code of Federal Regulations appliance federal efficiency standards. As of June 13, 2019, those are as defined below for Dehumidifiers:

Equipment Specification	Capacity (pints/day)	Federal Standard Criteria (L/kWh)
Portable Dehumidifier	≤25	≥1.30
	>25 and ≤ 50	≥1.60
	>50 and <155	≥2.80
Whole Home Dehumidifier	Product Case Volume	Federal Standard Criteria (L/kWh)
	≤ 8.0	≥ 1.77
	> 8.0	≥ 2.41

DEEMED LIFETIME OF EFFICIENT EQUIPMENT

The assumed lifetime for Portable Dehumidifiers is 12 years⁴⁸ and for Whole Home Humidifiers it is 17 years.⁴⁹

⁴⁸ EPA Research, 2012; ENERGY STAR Appliance Calculator,

⁴⁹ TECHNICAL SUPPORT DOCUMENT: ENERGY EFFICIENCY PROGRAM FOR CONSUMER PRODUCTS AND COMMERCIAL AND INDUSTRIAL EQUIPMENT: DEHUMIDIFIERS, October 2023. <https://www.regulations.gov/document/EERE-2019-BT-STD-0043-0023>, Appendix 8C. Lifetime is assumed to be the age at which there is an 80% cumulative probability that the unit has failed.

Analysis period is the same as the lifetime.

DEEMED MEASURE COST

The incremental cost is the difference in cost between a baseline and an ENERGY STAR qualified unit. Please see the table below for cost assumptions used:

Equipment Specification	Population	ENERGY STAR	ENERGY STAR Most Efficient
Portable Dehumidifier	Non-IQ ⁵⁰	\$9	\$12
	IQ ⁵¹	\$55	\$59
Whole Home Humidifier	Non-IQ ²	\$143 ⁵²	\$174
	IQ	N/A	N/A

LOADSHAPE

Loadshape R12 - Residential - Dehumidifier

COINCIDENCE FACTOR

The coincidence factor is assumed to be 50%.⁵³

Algorithm

CALCULATION OF SAVINGS

ELECTRIC ENERGY SAVINGS

$$\Delta kWh = (((Avg Capacity * 0.473) / 24) * Hours) * (IQAdj / (L/kWh_{Base}) - 1 / (L/kWh_{Eff}))$$

Where:

- Capacity = Water removal capacity of the unit (pints/day)
= Actual, if unknown assume capacity in each capacity range as provided in table below, or if capacity range unknown assume average.
- 0.473 = Constant to convert Pints to Liters
- 24 = Constant to convert Liters/day to Liters/hour
- Hours = Run hours per year
= 2,200⁵⁴
- IQAdj = Baseline consumption adjustment for IQ program participants to account for a portion

⁵⁰ Incremental cost data from the TECHNICAL SUPPORT DOCUMENT: ENERGY EFFICIENCY PROGRAM FOR CONSUMER PRODUCTS AND COMMERCIAL AND INDUSTRIAL EQUIPMENT: DEHUMIDIFIERS, October 2023. <https://www.regulations.gov/document/EERE-2019-BT-STD-0043-0023>. See Dehumidifiers_Calculation_Sheet_05-09-24.xlsx for more detail regarding the incremental cost data.

⁵¹ IQ Incremental costs factor in the assumption that a secondhand unit costs on average 50% of a new baseline unit, and that 1/3 of IQ participants would have purchased a unit on the secondhand market. The new baseline dehumidifier is assumed to cost \$262 based on values reported in: . See "IQ Appliance Calculations.xls" for information.

⁵² ENERGY STAR Version 6.0 Dehumidifiers Draft 1 Specification Stakeholder Webinar presentation, March 28, 2024. Purchase price incremental cost between current DOE standard and Draft 1 v.6.0 for units ≤ 8.0 ft³.

⁵³ Assume usage is evenly distributed day vs. night, weekend vs. weekday and is used between April through the end of September (4392 possible hours). With 2,200 operating hours, coincidence peak during summer peak is therefore 2200/4392 = 50.1%

⁵⁴ Based on Mattison et al., "Dehumidifiers: A Major Consumer of Residential Electricity", Cautley et al., "Dehumidification and

of participants who would have utilized the secondary market. ⁵⁵

= 1.096 for Portable Dehumidifiers if IQ, 1.0 if non-IQ or Whole Home Dehumidifiers

L/kWh

= Liters of water per kWh consumed, as provided in tables above

Annual kWh usage and savings, for each capacity class and product type, are presented in the four tables below:

Portable Dehumidifiers					Annual kWh			
Capacity Range	Capacity Used ⁵⁶	Federal Standard Criteria	ENERGY STAR Criteria / Average	ENERGY STAR Most Efficient Criteria / Average	Non-IQ Baseline: Federal Standard	IQ Baseline	ENERGY STAR	ENERGY STAR Most Efficient
(pints/day)	(pints/day)	(≥ L/kWh)	(≥ L/kWh)	(≥ L/kWh)				
≤25	22.3	1.3	1.57 / 1.64	1.75 / 1.78	744	815	590	543
>25 and ≤50	43.1	1.6	1.8 / 1.85	2.01 / 2.01	1168	1280	1010	930
>50 and <155	102.5	2.8	3.3 / NA	3.4 / NA	1587	1740	N/A	N/A
Average ⁵⁷	38.52	1.53	1.75 / 1.80	1.95 / 1.96	1075	1178	918	845
Whole Home Dehumidifiers					Annual kWh			
Product Case Volume (ft ³)								
≤ 8.0	81.85	1.77	2.09 / 2.295	2.22 / 2.35	2005	N/A	1546	1510
> 8.0	N/A	2.41	3.3 / NA	3.81 / N/A	N/A	N/A	N/A	N/A

Subslab Ventilation in Wisconsin Homes” and Yang et al., “Dehumidifier Use in the U.S. Residential Sector”, all indicating average usage around 2,200 hours per year.

⁵⁵ It is assumed that a second-hand unit is on average 2/3 of a measure’s EUL years old (8 years). In 2019 a new Federal Standard became effective and “relative to the previous standard, the current standard represents energy savings of about 15-25%”. 20% was used and increased by an estimate of 0.4% * 8 years (based on review of the refrigerator/freezer regression algorithm used in the 5.1.8 Refrigerator and Freezer Recycling measure) to account for degradation of performance over time. This secondhand consumption was then weighted 1/3: 2/3 current new baseline to estimate a multiplier for IQ participants. See “IQ Appliance Calculations.xls” for information.

⁵⁶ Capacity Used in calculations for each bin is an average. See next footnote regarding overall average for Portable Dehumidifiers

⁵⁷ Weighted Overall average based on ENERGY STAR Products List 2020 for Dehumidifiers, accessed May 2020. See sheet *ESTAR-2020-5* in file “ENERGY STAR Dehumidifier TRM Analysis_2021.xlsx”

Portable Dehumidifier		Energy Savings (ΔkWh)			
		Non-IQ		IQ	
Capacity Range (pints/day)	Capacity Used (pints/day)	ENERGY STAR	ENERGY STAR Most Efficient	ENERGY STAR	ENERGY STAR Most Efficient
≤25	22.3	154	201	226	272
>25 and ≤50	43.1	158	238	270	350
>50 and <155	102.5	N/A	N/A	N/A	N/A
Average	38.52	157	230	260	333
Whole Home Dehumidifiers		Energy Savings (ΔkWh)			
Product Case Volume (ft ³)					
≤ 8.0	81.85	459	495	N/A	N/A
> 8.0	N/A	N/A	N/A	N/A	N/A

SUMMER COINCIDENT PEAK DEMAND SAVINGS

$$\Delta kW = \Delta kWh/Hours * CF$$

Where:

CF = Summer Peak Coincidence Factor for measure
= 0.50⁵⁸

Summer coincident peak demand results for each capacity class are presented below:

Portable Dehumidifier		Energy Savings (ΔkW)			
		Non-IQ		IQ	
Capacity Range (pints/day)		ENERGY STAR	ENERGY STAR Most Efficient	ENERGY STAR	ENERGY STAR Most Efficient
≤25		0.026	0.036	0.041	0.050
>25 and ≤50		0.026	0.037	0.048	0.058
>50 and <155		0.055	0.064	0.089	0.098
Average		0.030	0.043	0.054	0.067
Whole Home Dehumidifier		Energy Savings (ΔkW)			
Product Case Volume (ft ³)					
≤ 8.0	81.85	459	495	N/A	N/A
> 8.0	N/A	N/A	N/A	N/A	N/A

⁵⁸ Assume usage is evenly distributed day vs. night, weekend vs. weekday and is used between April through the end of September (4392 possible hours). With 2200 operating hours, coincidence peak during summer peak is therefore 2200/4392 = 50.1%

FOSSIL FUEL SAVINGS

N/A

WATER IMPACT DESCRIPTIONS AND CALCULATION

N/A

DEEMED O&M COST ADJUSTMENT CALCULATION

N/A

MEASURE CODE: RS-APL-ESDH-V11-250101

REVIEW DEADLINE: 1/1/2028

5.1.4 ENERGY STAR Dishwasher

DESCRIPTION

A standard or compact residential dishwasher meeting ENERGY STAR standards is installed in place of a model meeting the federal standard.

This measure was developed to be applicable to the following program types: TOS, NC. If applied to other program types, the measure savings should be verified.

DEFINITION OF EFFICIENT EQUIPMENT

The efficient equipment is defined as a standard or compact dishwasher meeting the ENERGY STAR standards presented in the table below.

ENERGY STAR Requirements (Version 7.0, Effective July 19, 2023)

Dishwasher Type	Maximum kWh/year	Maximum gallons/cycle
Standard (≥ 8 place settings + six serving pieces)	240	3.2
Standard with Connected Functionality ⁵⁹	252	
Compact (< 8 place settings + six serving pieces)	155	2.0

DEFINITION OF BASELINE EQUIPMENT

The baseline reflects the minimum federal efficiency standards for dishwashers effective May 30, 2013, as presented in the table below.

Dishwasher Type	Maximum kWh/year	Maximum gallons/cycle
Standard	307	5.0
Compact	222	3.5

DEEMED LIFETIME OF EFFICIENT EQUIPMENT

The assumed lifetime of the measure is 11 years.⁶⁰

DEEMED MEASURE COST

The incremental cost for standard and compact dishwashers is provided in the table below:⁶¹

⁵⁹ The ENERGY STAR specification “establishes optional connected criteria for dishwashers. ENERGY STAR certified dishwashers with connected functionality offer favorable attributes for demand response programs to consider, since their peak energy consumption is relatively high, driven by water heating. ENERGY STAR certified dishwashers with connected functionality will offer consumers new convenience and energy-saving features, such as alerts for cycle completion and/or recommended maintenance, as well as feedback on the energy use of the product”. See ‘ENERGY STAR Residential Dishwasher Final Version 6.0 Cover Memo.pdf’. Calculated as per Version 6.0 specification; “ENERGY STAR Residential Dishwasher Version 6.0 Final Program Requirements.pdf”. As of July 2021, Version 7.0 specification is still under development. Note that the potential for demand response and additional peak savings from units with Connected Functionality have not been explored. This could be a potential addition in a future version.

⁶⁰ Measure lifetime from California DEER. See file California DEER 2014-EUL Table - 2014 Update.xlsx.

⁶¹ Costs are based on data from U.S. DOE, Final Rule Life-Cycle Cost (LCC) Spreadsheet. See file Residential Dishwasher Analysis_2021.xlsx for cost calculation details.

Dishwasher Type	Baseline Cost		ENERGY STAR Cost	Incremental Cost	
	Non-IQ	IQ ⁶²		Non-IQ	IQ
Standard	\$310	\$213.03	\$340	\$30	\$118.28
Compact	\$290.13	\$241.78	\$308.62	\$18.49	\$66.85

LOADSHAPE

Loadshape R02 - Residential Dish Washer

COINCIDENCE FACTOR

The coincidence factor is assumed to be 2.6%.⁶³

Algorithm

CALCULATION OF SAVINGS

ELECTRIC ENERGY SAVINGS

$$\Delta kWh^{64} = ((kWh_{BASE} - kWh_{ESTAR}) * (\%kWh_{op} + (\%kWh_{heat} * \%Electric_DHW)))$$

Where:

kWh_{BASE} = Baseline kWh consumption per year

Dishwasher Type	Maximum kWh/year	
	Non-IQ	IQ ⁶⁵
Standard	307	310
Compact	222	224

kWh_{ESTAR} = ENERGY STAR kWh annual consumption

Dishwasher Type	Maximum kWh/year
Standard	240
Standard with Connected Functionality	252
Compact	155

%kWh_{op} = Percentage of dishwasher energy consumption used for unit operation

$$= 100 - 56\%^{66}$$

⁶² IQ Incremental costs factor in the assumption that a secondhand unit costs on average 50% of a new baseline unit, and that 1/3 of IQ participants would have purchased a unit on the secondhand market. See "IQ Appliance Calculations.xls" for information.

⁶³ Calculated from Itron eShapes, 8760 hourly data by end use for Missouri, as provided by Ameren.

⁶⁴ The Federal Standard and ENERGY STAR annual consumption values include electric consumption for both the operation of the machine and for heating the water that is used by the machine.

⁶⁵ It is assumed that a secondhand unit is on average 2/3 of a measure's EUL years old (7 years). There has been no new Federal Standard in that period, but new unit baseline consumption is increased by an estimate of 0.4% * 7 years (based on review of the refrigerator/freezer regression algorithm used in the 5.1.8 Refrigerator and Freezer Recycling measure) to account for degradation of performance over time. This secondhand consumption was then weighted 1/3: 2/3 current new baseline to estimate a multiplier for IQ participants. See "IQ Appliance Calculations.xls" for information.

⁶⁶ ENERGY STAR Qualified Appliance Savings Calculator, last updated October 2016.

= 44%

%kWh_heat = Percentage of dishwasher energy consumption used for water heating
= 56%⁶⁷

%Electric_DHW = Percentage of DHW savings assumed to be electric
= 100 % for Electric
= 0 % for Fossil Fuel
= If unknown⁶⁸, use the following table:

Utility	Location				
	Single Family	Single Family Low Income	Multi Family	Multi Family Low Income	Unknown
Ameren ⁶⁹	24%	25%	40%	43%	28%
ComEd ⁷⁰	8%		11%		9%
People’s Gas ⁷¹	2.0%	2.0%	1.7%	2.1%	2.0%
Northshore Gas ⁷²	1.3%	1.8%	10.0%	2.4%	2.3%
Nicor Gas ⁷³	1.3%	1.8%	10.0%	2.4%	2.3%
All DUs⁷⁴					25%

Note: If a measure is supported by a gas and electric utility through a joint program, and it is unknown whether the participant has a gas supply, the electric utility values in the table above should be used. If it is known that the participant has a gas supply, the values from the gas utility above should be applied.

Dishwasher Type	ΔkWh - Non IQ			ΔkWh - IQ		
	With Electric DHW	With Gas DHW	With Unknown location and building type DHW	With Electric DHW	With Gas DHW	With Unknown location and building type DHW
ENERGY STAR Standard	67	29.5	38.9	69.8	30.7	40.6
ENERGY STAR Standard with Connected Functionality	55	24.2	31.9	57.8	25.4	33.7
ENERGY STAR Compact	67	29.5	38.9	69.1	30.4	40.1

Secondary kWh Savings for Water Supply and Wastewater Treatment

⁶⁷ Ibid.

⁶⁸ Based on the average % electricity used for water heating in Unknown residential structure types across all utilities covered by the IL program. Residence types include: SF, SF LI, MF & MF LI. Utilities included: Ameren, ComEd, People’s Gas, Northshore Gas & Nicor. Please see subsequent table and citations for specific sources.

⁶⁹ Provided by AEG from the 2020 Market Potential Study completed for AIC, as well as AIC Income Qualified Initiative: 2021 Participant Survey Results Memo (February 1, 2022) p. 17.

⁷⁰ Commonwealth Edison Residential Baseline Study (2020). p.4.4 & 4.19; Section 4-7 Water Heating. Prepared by Itron.

⁷¹ Implementation Contractors data from Peoples Gas and North Shore Gas for PY2022-2023.

⁷² Ibid.

⁷³ Comparable service area & customers to NSG, therefore using their survey data.

⁷⁴ For the weighted average calculations, please see the Analysis file. PGL, NSG, Nicor & gas customers were assumed to follow the provided split. ComEd total customers, minus overlap with PGL,NSG & Nicor, therefore electric only homes. Ameren is total customers minus Nicor.

The following savings should be included in the total savings for this measure but should not be included in TRC tests to avoid double counting the economic benefit of water savings.

$$\Delta kWh_{\text{water}} = \Delta \text{Water (gallons)} / 1,000,000 * E_{\text{water total}}$$

Where

$$E_{\text{water total}} = \text{IL Total Water Energy Factor (kWh/Million Gallons)} \\ = 5,010^{75}$$

Using defaults provided:

Standard $\Delta kWh_{\text{water}} = 252/1,000,000 * 5,010$
 $= 1.3 \text{ kWh}$

Compact $\Delta kWh_{\text{water}} = 67/1,000,000 * 5,010$
 $= 0.3 \text{ kWh}$

SUMMER COINCIDENT PEAK DEMAND SAVINGS⁷⁶

$$\Delta kW = \Delta kWh/\text{Hours} * CF$$

Where:

ΔkWh = Annual kWh savings from measure as calculated above. Note do not include the secondary savings in this calculation.

Hours = Annual operating hours⁷⁷
 $= 353 \text{ hours}$

CF = Summer Peak Coincidence Factor
 $= 2.6\%^{78}$

Dishwasher Type	ΔkW - Non IQ			ΔkW - IQ		
	With Electric DHW	With Gas DHW	With Unknown location and building type DHW	With Electric DHW	With Gas DHW	With Unknown location and building type DHW
ENERGY STAR Standard	0.0049	0.0022	0.0029	0.0051	0.0023	0.0030
ENERGY STAR Standard with Connected Functionality	0.0041	0.0018	0.0024	0.0043	0.0019	0.0025
ENERGY STAR Compact	0.0049	0.0022	0.0029	0.0051	0.0022	0.0030

⁷⁵ This factor includes 2571 kWh/MG for water supply based on Illinois energy intensity data from a 2012 ISAWWA study and 2439 kWh/MG for wastewater treatment based on national energy intensity use estimates. For more information, please review Elevate Energy’s ‘IL TRM: Energy per Gallon Factor, May 2018 paper’.

⁷⁶ Note that the potential for demand response and additional peak savings from units with Connected Functionality have not been explored. This could be a potential addition in a future version.

⁷⁷ Assuming 2.1 hours per cycle and 168 cycles per year therefore 353 operating hours per year. 168 cycles per year is based on a weighted average of dishwasher usage in Illinois derived from the 2009 RECs data.

⁷⁸ End use data from Ameren representing the average DW load during peak hours/peak load.

FOSSIL FUEL SAVINGS

$$\Delta \text{Therm} = (\text{kWh}_{\text{Base}} - \text{kWh}_{\text{ESTAR}}) * \% \text{kWh}_{\text{heat}} * \% \text{Fossil_DHW} * R_{\text{eff}} * 0.03412$$

Where

$\% \text{kWh}_{\text{heat}}$ = % of dishwasher energy used for water heating
 = 56%

$\% \text{Fossil_DHW}$ = Percentage of DHW savings assumed to be fossil fuel
 = 100 % for Fossil Fuel
 = 0 % for Electric

= If unknown⁷⁹, use the following table:

Utility	Location				
	Single Family	Single Family Low Income	Multi Family	Multi Family Low Income	Unknown
Ameren ⁸⁰	76%	75%	60%	57%	72%
ComEd ⁸¹	92%		89%		91%
People’s Gas ⁸²	97.9%	98.0%	98.3%	97.6%	97.8%
Northshore Gas ⁸³	98.5%	98.2%	90.0%	97.6%	97.6%
Nicor Gas ⁸⁴	98.5%	98.2%	90.0%	97.6%	97.6%
All DUs⁸⁵					75%

Note: If a measure is supported by a gas and electric utility through a joint program, and it is unknown whether the participant has a gas supply, the electric utility values in the table above should be used. If it is known that the participant has a gas supply, the values from the gas utility above should be applied.

R_{eff} = Recovery efficiency factor
 = 1.26⁸⁶

0.03412 = factor to convert from kWh to Therm

⁷⁹ Based on the average % electricity used for water heating in Unknown residential structure types across all utilities covered by the IL program. Residence types include: SF, SF LI, MF & MF LI. Utilities included: Ameren, ComEd, People’s Gas, Northshore Gas & Nicor. Please see subsequent table and citations for specific sources.

⁸⁰ Provided by AEG from the 2020 Market Potential Study completed for AIC, as well as AIC Income Qualified Initiative: 2021 Participant Survey Results Memo (February 1, 2022) p. 17.

⁸¹ Commonwealth Edison Residential Baseline Study (2020). p.4.4 & 4.19; Section 4-7 Water Heating. Prepared by Itron.

⁸² Residential Appliance Saturation Survey of natural gas for space heating and water heating (2021). Note, Multifamily customers have a residential billing rate code and responded on the survey that they live in an apartment or condominium in a building that has either 2-4 or 5+ units.

⁸³ Ibid.

⁸⁴ Comparable service area & customers to NSG, therefore using their survey data.

⁸⁵ For the weighted average calculations, please see the Analysis file. PGL, NSG, Nicor & gas customers were assumed to follow the provided split. ComEd total customers, minus overlap with PGL,NSG & Nicor, therefore gas only homes. Ameren is total customers minus Nicor.

⁸⁶ To account for the different efficiency of electric and natural gas hot water heaters (gas water heater: recovery efficiencies ranging from 0.74 to 0.85 (0.78 used), and electric water heater with 0.98 recovery efficiency (see ENERGY STAR Waste Water Heat Recovery Guidelines). Therefore, a factor of 0.98/0.78 (1.26) is applied.

Dishwasher Type	ΔTherms - Non IQ			ΔTherms - IQ		
	With Electric DHW	With Gas DHW	With Unknown location and building type DHW	With Electric DHW	With Gas DHW	With Unknown location and building type DHW
ENERGY STAR Standard	0	1.61	1.21	0	1.68	1.26
ENERGY STAR Standard with Connected Functionality	0	1.32	0.99	0	1.39	1.05
ENERGY STAR Compact	0	1.61	1.21	0	1.66	1.24

WATER IMPACT DESCRIPTIONS AND CALCULATION

$$\Delta\text{Water (gallons)} = \text{Water}_{\text{Base}} - \text{Water}_{\text{EFF}}$$

Where:

$\text{Water}_{\text{Base}}$ = water consumption of conventional unit

Dishwasher Type	$\text{Water}_{\text{Base}}$ (gallons) ⁸⁷
Standard	840
Compact	588

$\text{Water}_{\text{EFF}}$ = annual water consumption of efficient unit:

Dishwasher Type	$\text{Water}_{\text{EFF}}$ (gallons) ⁸⁸
Standard	538
Compact	336

Dishwasher Type	ΔWater (gallons)
ENERGY STAR Standard	302
ENERGY STAR Compact	252

DEEMED O&M COST ADJUSTMENT CALCULATION

N/A

MEASURE CODE: RS-APL-ESDI-V11-250101

REVIEW DEADLINE: 1/1/2029

⁸⁷ Assuming maximum allowed from specifications and 168 cycles per year based on a weighted average of dishwasher usage in Illinois derived from the 2009 RECs data.

⁸⁸ Ibid

5.1.5 ENERGY STAR Freezer

DESCRIPTION

A freezer meeting the efficiency specifications of ENERGY STAR is installed in place of a model meeting the federal standard (NAECA). Energy usage specifications are defined in the table below (note, AV is the freezer Adjusted Volume and is calculated as 1.73*Total Volume):

Product Category	Volume (cubic feet)	Assumptions after September 2014	
		Federal Baseline Maximum Energy Usage in kWh/year ⁸⁹	ENERGY STAR Maximum Energy Usage in kWh/year ⁹⁰
Upright Freezers with Manual Defrost	7.75 or greater	$5.57*AV + 193.7$	$5.01*AV + 174.3$
Upright Freezers with Automatic Defrost	7.75 or greater	$8.62*AV + 228.3$	$7.76*AV + 205.5$
Chest Freezers and all other Freezers except Compact Freezers	7.75 or greater	$7.29*AV + 107.8$	$6.56*AV + 97.0$
Compact Upright Freezers with Manual Defrost	< 7.75 and 36 inches or less in height	$8.65*AV + 225.7$	$7.79*AV + 203.1$
Compact Upright Freezers with Automatic Defrost	< 7.75 and 36 inches or less in height	$10.17*AV + 351.9$	$9.15*AV + 316.7$
Compact Chest Freezers	<7.75 and 36 inches or less in height	$9.25*AV + 136.8$	$8.33*AV + 123.1$

This measure was developed to be applicable to the following program types: TOS, NC.

If applied to other program types, the measure savings should be verified.

DEFINITION OF EFFICIENT EQUIPMENT

The efficient equipment is defined as a freezer meeting the efficiency specifications of ENERGY STAR, as defined below and calculated above:

Equipment	Volume	Criteria
Full Size Freezer	7.75 cubic feet or greater	At least 10% more energy efficient than the minimum federal government standard (NAECA).
Compact Freezer	Less than 7.75 cubic feet and 36 inches or less in height	At least 20% more energy efficient than the minimum federal government standard (NAECA).

DEFINITION OF BASELINE EQUIPMENT

The baseline equipment is assumed to be a model that meets the federal minimum standard for energy efficiency. The standard varies depending on the size and configuration of the freezer (chest freezer or upright freezer, automatic or manual defrost) and is defined in the table above.

⁸⁹ See Department of Energy Federal Standards, (10 CFR Part 430.32(a)), effective September 15th, 2014.

⁹⁰ See Version 5.1 ENERGY STAR specification.

DEEMED LIFETIME OF EFFICIENT EQUIPMENT

The measure life is assumed to be 21 years for standard size and 10 years for compact freezers.⁹¹

DEEMED MEASURE COST

The incremental cost for this measure is \$5⁹² for non-IQ participants and \$104 for IQ participants.⁹³

LOADSHAPE

Loadshape R04 - Residential Freezer

COINCIDENCE FACTOR

The summer peak coincidence factor for this measure is assumed to be 95%.⁹⁴

Algorithm

CALCULATION OF SAVINGS

ELECTRIC ENERGY SAVINGS:

$$\Delta kWh = (kWh_{BASE} * IQAdj) - kWh_{ESTAR}$$

Where:

- kWh_{BASE} = Baseline kWh consumption per year as calculated in algorithm provided in table above.
- IQAdj = Baseline consumption adjustment for IQ program participants to account for a portion of participants who would have utilized the secondary market.⁹⁵
= 1.14 if IQ, 1.0 if non-IQ
- kWh_{ESTAR} = ENERGY STAR kWh consumption per year as calculated in algorithm provided in table above.

⁹¹ Based on 2021 DOE Rulemaking Technical Support Document, “Refrigerator, Refrigerator-Freezer, and Freezer Life-Cycle Cost (LCC) Analysis Spreadsheet” posted November 9, 2021.

⁹² Costs are estimated using the data provided in the Department of Energy, “Refrigerator, Refrigerator-Freezer, and Freezer Life-Cycle Cost (LCC) Analysis Spreadsheet” posted November 9, 2021 as part of the ‘Energy Conservation Standards for Consumer Refrigerators, Refrigerator-Freezers, and Freezers’ rulemaking docket. Install cost data was trended to provide estimates at the efficiency levels specified in this measure, and then weighted based on available product on the ENERGY STAR Freezer QPI, accessed 4/29/2022. See “DOE LCC Spreadsheet_Freezer.xls” for more information.

⁹³ IQ Incremental costs factor in the assumption that a secondhand unit costs on average 50% of a new baseline unit, and that 1/3 of IQ participants would have purchased a unit on the secondhand market. See “IQ Appliance Calculations.xls” for information.

⁹⁴ Based on eShapes Residential Freezer load data as provided by Ameren.

⁹⁵ It is assumed that a second-hand unit is on average 2/3 of a measure’s EUL years old (14 years). The current Federal Standard became effective in 2014 so the previous standard is used to estimate base consumption for a second hand unit, and further increased by an estimate of 0.4% * 14 years (based on review of the refrigerator/freezer regression algorithm used in the 5.1.8 Refrigerator and Freezer Recycling measure) to account for degradation of performance over time. This second hand consumption was then weighted 1/3: 2/3 current new baseline to estimate a multiplier for IQ participants. See “IQ Appliance Calculations.xls” for information.

For example for a 7.75 cubic foot Upright Freezers with Manual Defrost purchased by non-IQ participant after September 2014:

$$\begin{aligned} \Delta\text{kWh} &= ((5.57*(7.75* 1.73)+193.7)) * 1) - (5.01*(7.75* 1.73)+174.3) \\ &= 268.4 - 241.5 \\ &= 26.9 \text{ kWh} \end{aligned}$$

If volume is unknown, use the following default values:

Product Category	Adjusted Volume Used ⁹⁶	kWh _{BASE}		kWh _{ESTAR}	ΔkWh	
		Non-IQ	IQ		Non-IQ	IQ
Upright Freezers with Manual Defrost	15	277.3	316	249.5	27.8	66.2
Upright Freezers with Automatic Defrost	26.2	453.9	517	408.6	45.3	108.1
Chest Freezers and all other Freezers except Compact Freezers	22.5	271.9	310	244.7	27.2	64.8
Compact Upright Freezers with Manual Defrost	5.5	273.3	311	246	27.3	65.1
Compact Upright Freezers with Automatic Defrost	7.5	428.6	488	385.7	42.9	102.2
Compact Chest Freezers	9.5	224.8	256	202.4	22.5	53.5

SUMMER COINCIDENT PEAK DEMAND SAVINGS

$$\Delta\text{kW} = \Delta\text{kWh} / \text{Hours} * \text{CF}$$

Where:

ΔkWh = Gross customer annual kWh savings for the measure

Hours = Full Load hours per year
= 5890⁹⁷

CF = Summer Peak Coincident Factor
= 0.95⁹⁸

For example, for a 7.75 cubic foot Upright Freezers with Manual Defrost purchased by non-IQ participant:

$$\begin{aligned} \Delta\text{kW} &= 26.9 / 5890 * 0.95 \\ &= 0.0043 \text{ kW} \end{aligned}$$

If volume is unknown, use the following default values:

Product Category	ΔkW	
	Non-IQ	IQ
Upright Freezers with Manual Defrost	0.0045	0.0107

⁹⁶ Volume is based on average adjusted volume of units on the ENERGY STAR QPI, accessed 4/29/2022. See “DOE LCC Spreadsheet_Freezer.xls” for more information.

⁹⁷ Calculated from eShapes Residential Freezer load data as provided by Ameren by dividing total annual load by the maximum kW in any one hour.

⁹⁸ Based on eShapes Residential Freezer load data as provided by Ameren.

Product Category	ΔkW	
	Non-IQ	IQ
Upright Freezers with Automatic Defrost	0.0073	0.0174
Chest Freezers and all other Freezers except Compact Freezers	0.0044	0.0105
Compact Upright Freezers with Manual Defrost	0.0044	0.0105
Compact Upright Freezers with Automatic Defrost	0.0069	0.0165
Compact Chest Freezers	0.0036	0.0086

FOSSIL FUEL SAVINGS

N/A

WATER IMPACT DESCRIPTIONS AND CALCULATION

N/A

DEEMED O&M COST ADJUSTMENT CALCULATION

N/A

MEASURE CODE: RS-APL-ESFR-V05-240101

REVIEW DEADLINE: 1/1/2027

5.1.6 ENERGY STAR, CEE Tier 2 or CEE Tier 3 Refrigerator

DESCRIPTION

This measure relates to:

- a) Time of Sale: the purchase and installation of a new refrigerator meeting either ENERGY STAR, CEE TIER 2 or TIER 3 specifications.
- b) Early Replacement: the early removal of an existing residential inefficient Refrigerator from service, prior to its natural end of life, and replacement with a new ENERGY STAR, CEE Tier 2 or Tier 3 qualifying unit. Savings are calculated between existing unit and efficient unit consumption during the remaining life of the existing unit, and between new baseline unit and efficient unit consumption for the remainder of the measure life.

Energy usage specifications are defined in the table below (note, Adjusted Volume is calculated as the fresh volume + (1.63 * Freezer Volume):

Product Category	Existing Unit	Assumptions after September 2014	
	Based on Refrigerator Recycling algorithm	Federal Baseline Maximum Energy Usage in kWh/year ⁹⁹	ENERGY STAR Maximum Energy Usage in kWh/year ¹⁰⁰
1. Refrigerators and Refrigerator-freezers with manual defrost	Use Algorithm in 5.1.8 Refrigerator and Freezer Recycling measure to estimate existing unit consumption	6.79AV + 193.6	6.11 * AV + 174.2
2. Refrigerator-Freezer--partial automatic defrost		7.99AV + 225.0	7.19 * AV + 202.5
3. Refrigerator-Freezers--automatic defrost with top-mounted freezer without through-the-door ice service and all-refrigerators--automatic defrost		8.07AV + 233.7	7.26 * AV + 210.3
4. Refrigerator-Freezers--automatic defrost with side-mounted freezer without through-the-door ice service		8.51AV + 297.8	7.66 * AV + 268.0
5. Refrigerator-Freezers--automatic defrost with bottom-mounted freezer without through-the-door ice service		8.85AV + 317.0	7.97 * AV + 285.3
5A Refrigerator-freezer—automatic defrost with bottom-mounted freezer with through-the-door ice service		9.25AV + 475.4	8.33 * AV + 436.3
6. Refrigerator-Freezers--automatic defrost with top-mounted freezer with through-the-door ice service		8.40AV + 385.4	7.56 * AV + 355.3
7. Refrigerator-Freezers--automatic defrost with side-mounted freezer with through-the-door ice service	8.54AV + 432.8	7.69 * AV + 397.9	

This measure was developed to be applicable to the following program types: TOS, NC, EREP.

If applied to other program types, the measure savings should be verified.

DEFINITION OF EFFICIENT EQUIPMENT

The efficient equipment is defined as a refrigerator meeting the efficiency specifications of ENERGY STAR, CEE Tier 2 or CEE Tier 3 (defined as requiring >= 10%, >= 15% or >=20% less energy consumption than an equivalent unit

⁹⁹ See Department of Energy Federal Standards (10 CFR Part 430.32(a)), effective September 15th, 2014.

¹⁰⁰ See Version 5.1 ENERGY STAR specification.

meeting federal standard requirements respectively). The ENERGY STAR standard varies according to the size and configuration of the unit, as shown in table above.

DEFINITION OF BASELINE EQUIPMENT

Time of Sale: baseline is a new refrigerator meeting the minimum federal efficiency standard for refrigerator efficiency. The current federal minimum standard varies according to the size and configuration of the unit, as shown in table above. This Federal Standard is effective for units manufactured after September 1, 2014. Note in December 2021, the DOE presented preliminary analysis for the purposes of evaluating energy conservation standards. The review deadline will be set for one further year to review progress in standard updates.

Early Replacement: the baseline is the existing refrigerator for the assumed remaining useful life of the unit and the new baseline as defined above for the remainder of the measure life.

DEEMED LIFETIME OF EFFICIENT EQUIPMENT

The measure life is assumed to be 15 years.¹⁰¹

Remaining life of existing equipment is assumed to be 5 years.¹⁰²

DEEMED MEASURE COST

Time of Sale: The incremental cost for non-IQ participants is assumed to be \$9 for an ENERGY STAR unit, \$26 for a CEE Tier 2 unit and \$135 for a CEE Tier 3 unit.¹⁰³

For IQ participants the incremental cost is assumed to be \$154 for an ENERGY STAR unit, \$171 for a CEE Tier 2 unit and \$180 for a CEE Tier 3 unit.¹⁰⁴

Early Replacement: The measure cost is the full cost of removing the existing unit and installing a new one. The actual program cost should be used. If unavailable, assume \$878 for ENERGY STAR unit, \$895 for CEE Tier 2 unit and \$904 for CEE Tier 3 units.

The avoided replacement cost (after 5 years) of a baseline replacement refrigerator is \$869. This cost should be discounted to present value using the nominal societal discount rate.

LOADSHAPE

Loadshape R05 - Residential Refrigerator

COINCIDENCE FACTOR

A coincidence factor is not used to calculate peak demand savings for this measure, see below.

¹⁰¹ Based on 2021 DOE Rulemaking Technical Support Document, "Refrigerator, Refrigerator-Freezer, and Freezer Life-Cycle Cost (LCC) Analysis Spreadsheet" posted November 9, 2021.

¹⁰² Standard assumption of one third of effective useful life.

¹⁰³ Costs are estimated using the data provided in the Guidehouse and Leidos Technology Forecast Updates Residential and Commercial Building Technologies Reference Case presented to U.S. Energy Information Administration March 3, 2023.

¹⁰⁴ IQ Incremental costs factor in the assumption that a secondhand unit costs on average 50% of a new baseline unit, and that 1/3 of IQ participants would have purchased a unit on the secondhand market. See "IQ Appliance Calculations.xls" for information.

Algorithm

CALCULATION OF SAVINGS

ELECTRIC ENERGY SAVINGS:

Time of Sale: $\Delta kWh = (UEC_{BASE} * IQAdj) - UEC_{EE}$

Early Replacement:

ΔkWh for remaining life of existing unit (1st 5 years) = $UEC_{EXIST} - UEC_{EE}$

ΔkWh for remaining measure life (next 10 years) = $(UEC_{BASE} * IQAdj) - UEC_{EE}$

Where:

UEC_{EXIST} = Annual Unit Energy Consumption of existing unit as calculated in algorithm from 5.1.8 Refrigerator and Freezer Recycling measure.

UEC_{BASE} = Annual Unit Energy Consumption of baseline unit as calculated in algorithm provided in table above.

$IQAdj$ = Baseline consumption adjustment for IQ program participants to account for a portion of participants who would have utilized the secondary market.¹⁰⁵
 = 1.04 if IQ, 1.0 if non-IQ

UEC_{EE} = Annual Unit Energy Consumption of ENERGY STAR unit as calculated in algorithm provided in table above. For CEE Tier 2, unit consumption is calculated as 15% lower than baseline and for CEE Tier 3 20% lower than baseline.

If volume is unknown, use the following defaults, based on an assumed Adjusted Volume of 22.9:¹⁰⁶

Product Category	Existing Unit UEC_{EXIST} ¹⁰⁷	Baseline Unit UEC_{BASE}		New Efficient UEC_{EE}		
		Non-IQ	IQ	ENERGY STAR	CEE T2	CEE T3
1. Refrigerators and Refrigerator-freezers with manual defrost	998.2	349.2	363	314.2	296.8	279.4
2. Refrigerator-Freezer--partial automatic defrost	998.2	408.1	424	367.3	346.9	326.5
3. Refrigerator-Freezers--automatic defrost with top-mounted freezer without through-the-door ice service and all-refrigerators--automatic defrost	794.8	418.6	435	376.7	355.8	334.9
4. Refrigerator-Freezers--automatic defrost with side-mounted freezer without through-the-door ice service	1201.6	492.8	512	443.5	418.9	394.2
5. Refrigerator-Freezers--automatic defrost with bottom-mounted freezer without through-the-door ice service	794.8	519.8	540	467.9	441.8	415.8

¹⁰⁵ It is assumed that a second-hand unit is on average 2/3 of a measure’s EUL years old (10 years). The current Federal Standard became effective in 2014 so the previous standard is used to estimate base consumption for a second hand unit, and further increased by an estimate of 0.4% * 10 years (based on review of the refrigerator/freezer regression algorithm used in the 5.1.8 Refrigerator and Freezer Recycling measure) to account for degradation of performance over time. This second hand consumption was then weighted 1/3: 2/3 current new baseline to estimate a multiplier for IQ participants. See “IQ Appliance Calculations.xls” for information.

¹⁰⁶ Volume is based on the average adjusted volume of applicable units on the ENERGY STAR QPI, accessed 4/29/2022.

¹⁰⁷ Estimates of existing unit consumption are based on using the 5.1.8 Refrigerator and Freezer Recycling algorithm and the inputs described here: Age = 10 years, Pre-1990 = 0, Size = 18.9 ft3 (average of applicably units on ENERGY STAR QPI, accessed 4/29/2022), Single Door = 0, Side by side = 1 for classifications stating side by side, 0 for classifications stating top/bottom, and 0.5 for classifications that do not distinguish, Primary appliances = 1, unconditioned = 0, Part use factor = 0.

Product Category	Existing Unit UEC _{EXIST} ¹⁰⁷	Baseline Unit UEC _{BASE}		New Efficient UEC _{EE}		
		Non-IQ	IQ	ENERGY STAR	CEE T2	CEE T3
5A Refrigerator-freezer—automatic defrost with bottom-mounted freezer with through-the-door ice service	794.8	687.4	715	627.2	584.3	549.9
6. Refrigerator-Freezers--automatic defrost with top-mounted freezer with through-the-door ice service	794.8	577.9	601	528.5	491.2	462.3
7. Refrigerator-Freezers--automatic defrost with side-mounted freezer with through-the-door ice service	1201.6	628.5	653	574.1	534.2	502.8

Product Category	Early Replacement (1st 5 years) ΔkWh			Time of Sale and Early Replacement (last 10 years) ΔkWh					
				Non-IQ			IQ		
	ENERGY STAR	CEE T2	CEE T3	ENERGY STAR	CEE T2	CEE T3	ENERGY STAR	CEE T2	CEE T3
1. Refrigerators and Refrigerator-freezers with manual defrost	684	701.4	718.9	35.0	52.4	69.8	48.9	66.3	83.7
2. Refrigerator-Freezer--partial automatic defrost	631	651.4	671.8	40.8	61.2	81.6	57.0	77.4	97.8
3. Refrigerator-Freezers--automatic defrost with top-mounted freezer without through-the-door ice service and all-refrigerators--automatic defrost	418.2	439	459.9	42.00	62.8	83.7	58.5	79.4	100.3
4. Refrigerator-Freezers--automatic defrost with side-mounted freezer without through-the-door ice service	758.1	782.7	807.4	49.3	73.9	98.6	68.9	93.5	118.2
5. Refrigerator-Freezers--automatic defrost with bottom-mounted freezer without through-the-door ice service	326.9	353	379	51.9	78	104	72.5	98.6	124.6
5A Refrigerator-freezer—automatic defrost with bottom-mounted freezer with through-the-door ice service	167.7	210.6	244.9	60.2	103.1	137.5	87.5	130.4	164.8
6. Refrigerator-Freezers--automatic defrost with top-mounted freezer with through-the-door ice service	266.3	303.6	332.5	49.3	86.7	115.6	72.4	109.7	138.6
7. Refrigerator-Freezers--automatic defrost with side-mounted freezer with through-the-door ice service	627.5	667.4	698.8	54.4	94.3	125.7	79.4	119.3	150.7

SUMMER COINCIDENT PEAK DEMAND SAVINGS

$$\Delta kW = (\Delta kWh/8766) * TAF * LSAF$$

Where:

TAF = Temperature Adjustment Factor

= 1.25¹⁰⁸

LSAF = Load Shape Adjustment Factor

= 1.057¹⁰⁹

If volume is unknown, use the following defaults:

Product Category	Early Replacement (1st 5 years) ΔkW			Time of Sale and Early Replacement (last 10 years) ΔkW					
				Non-IQ			IQ		
	ENERGY STAR	CEE T2	CEE T3	ENERGY STAR	CEE T2	CEE T3	ENERGY STAR	CEE T2	CEE T3
1. Refrigerators and Refrigerator-freezers with manual defrost	0.103	0.106	0.108	0.005	0.008	0.011	0.007	0.010	0.013
2. Refrigerator-Freezer--partial automatic defrost	0.095	0.098	0.101	0.006	0.009	0.012	0.009	0.012	0.015
3. Refrigerator-Freezers--automatic defrost with top-mounted freezer without through-the-door ice service and all-refrigerators--automatic defrost	0.063	0.066	0.069	0.006	0.009	0.013	0.009	0.012	0.015
4. Refrigerator-Freezers--automatic defrost with side-mounted freezer without through-the-door ice service	0.114	0.118	0.122	0.007	0.011	0.015	0.010	0.014	0.018
5. Refrigerator-Freezers--automatic defrost with bottom-mounted freezer without through-the-door ice service	0.049	0.053	0.057	0.008	0.012	0.016	0.011	0.015	0.019
5A Refrigerator-freezer—automatic defrost with bottom-mounted freezer with through-the-door ice service	0.025	0.032	0.037	0.009	0.016	0.021	0.013	0.020	0.025
6. Refrigerator-Freezers--automatic defrost with top-mounted freezer with through-the-door ice service	0.04	0.046	0.05	0.007	0.013	0.017	0.011	0.017	0.021
7. Refrigerator-Freezers--automatic defrost with side-mounted freezer with through-the-door ice service	0.095	0.101	0.105	0.008	0.014	0.019	0.012	0.018	0.023

FOSSIL FUEL SAVINGS

N/A

WATER IMPACT DESCRIPTIONS AND CALCULATION

N/A

¹⁰⁸ Average temperature adjustment factor (to account for temperature conditions during peak period as compared to year as a whole) based on Blasnik, Michael, "Measurement and Verification of Residential Refrigerator Energy Use, Final Report, 2003-2004 Metering Study", July 29, 2004 (p. 47). It assumes 90 °F average outside temperature during peak period, 71°F average temperature in kitchens and 65°F average temperature in basement, and uses assumption that 66% of homes in Illinois have central cooling (CAC saturation: "Table HC7.9 Air Conditioning in Homes in Midwest Region, Divisions, and States, 2009 from Energy Information Administration", 2009 Residential Energy Consumption Survey).

¹⁰⁹ Daily load shape adjustment factor (average load in peak period /average daily load) also based on Blasnik, Michael, "Measurement and Verification of Residential Refrigerator Energy Use, Final Report, 2003-2004 Metering Study", July 29, 2004 (p. 48, using the average Existing Units Summer Profile for hours 13 through 17)

DEEMED O&M COST ADJUSTMENT CALCULATION

N/A

MEASURE CODE: RS-APL-ESRE-V11-250101

REVIEW DEADLINE: 1/1/2027

5.1.7 ENERGY STAR and CEE Tier 2 Room Air Conditioner

DESCRIPTION

This measure relates to:

- a) Time of Sale the purchase and installation of a room air conditioning unit that meets ENERGY STAR version 5.0, which is effective October 30th 2023¹¹⁰, or CEE Tier 2 minimum qualifying efficiency specifications, in place of a baseline unit. The baseline is based on the Federal Standard effective June 1st, 2014.
- b) Assumptions for IQ participants: This measure can be used by programs supporting the installation of efficient Room AC in income qualified households. It is assumed that the Room AC's installed in IQ households are being used less as a luxury and more as a necessity and that access to a single AC unit per household will result in run hours more consistent with central AC usage.

Product Type and Class (Btu/hr)		Federal Standard with louvered sides (CEER) ¹¹¹	Federal Standard without louvered sides (CEER)	ENERGY STAR v5.0 with louvered sides (CEER) ¹¹²	ENERGY STAR v5.0 without louvered sides (CEER)	CEE Tier 2 (CEER) ¹¹³
Without Reverse Cycle	< 6,000	11.0	10.0	13.1	12.8	14.85
	6,000 - 7,999			13.7		
	8,000 to 10,999	10.9	9.6	14.7	13.0	14.72
	11,000 to 13,999	10.9	9.5	14.7	12.8	14.72
	14,000 to 19,999	10.7	9.3	14.4	12.6	14.45
	20,000 to 27,999	9.4	9.4	12.7	12.7	12.69
	>=28,000	9.0	9.4	12.2	12.7	12.15
With Reverse Cycle	<14,000	9.8	9.3	13.2	12.6	N/A
	14,000 to 19,999	9.8	8.7	13.2	11.7	N/A
	>=20,000	9.3	8.7	12.6	11.7	N/A
Casement only		9.5		12.8		
Casement-Slider		10.4		14.0		

Side louvers extend from a room air conditioner model in order to position the unit in a window. A model without louvered sides is placed in a built-in wall sleeve and are commonly referred to as "through-the-wall" or "built-in" models.

Casement-only refers to a room air conditioner designed for mounting in a casement window of a specific size.

Casement-slider refers to a room air conditioner with an encased assembly designed for mounting in a sliding or casement window of a specific size.

Reverse cycle refers to the heating function found in certain room air conditioner models.

- a) Early Replacement: the early removal of an existing residential inefficient Room AC unit from service, prior to its natural end of life, and replacement with a new ENERGY STAR qualifying unit. Savings are calculated between existing unit and efficient unit consumption during the remaining life of the existing unit, and between new baseline unit and efficient unit consumption for the remainder of the measure life.

¹¹⁰ ENERGY STAR Version 5.0 Room Air Conditioners Program Requirements

¹¹¹ See DOE's Appliance and Equipment Standards for Room AC;

¹¹² ENERGY STAR Version 5.0 Room Air Conditioners Program Requirements

¹¹³ The Consortium for Energy Efficiency Super Efficient Home Appliance Initiative, Room Air Conditioner Specification, CEE Advanced Tier (CEER), effective May 17, 2022. Please see file "CEE_RoomAC_Specification_17May2022.pdf".

https://cee1.org/images/pdf/CEE_RoomAC_Specification_17May2022.pdf

This measure was developed to be applicable to the following program types: TOS, NC, EREP.

If applied to other program types, the measure savings should be verified.

DEFINITION OF EFFICIENT EQUIPMENT

To qualify for this measure, the new room air conditioning unit must meet the ENERGY STAR version 5.0, which is effective October 30th 2023¹¹⁴, efficiency standards presented above.

DEFINITION OF BASELINE EQUIPMENT

Time of Sale: the baseline assumption is a new room air conditioning unit that meets the Federal Standard (effective June 1st, 2014)¹¹⁵ efficiency standards as presented above.

Early Replacement: the baseline is the existing Room AC for the assumed remaining useful life of the unit and the new baseline as defined above for the remainder of the measure life.

For Income Qualified units, the baseline assumption is an inefficient unit either existing in the home or being purchased or acquired via the secondary market.

DEEMED LIFETIME OF EFFICIENT EQUIPMENT

The measure life is assumed to be 12 years.¹¹⁶

Remaining life of existing equipment is assumed to be 4 years.¹¹⁷

For Income Qualified units, because the baseline unit is assumed to be purchased from the secondary market, it is assumed that the remaining life of the baseline unit is 6 years and would need to be replaced with another unit from the secondary market at that point.

DEEMED MEASURE COST

Non-IQ Participants:

Time of Sale: The incremental cost for this measure is assumed to be \$40 for an ENERGY STAR unit and \$261 for a CEE Tier 2 unit.¹¹⁸

Early Replacement: The measure cost is the full cost of removing the existing unit and installing a new one. The actual program cost should be used. If unavailable assume \$448 for ENERGY STAR unit and \$669 for CEE Tier 2 unit.¹¹⁹

The avoided replacement cost (after 4 years) of a baseline replacement unit is \$432.¹²⁰ This cost should be discounted to present value using the nominal societal discount rate.

Income Qualified participants:

The actual full cost of the ENERGY STAR unit should be used. If unavailable assume \$300.¹²¹ If a CEE Tier 2 unit is installed assume \$508. The cost of the inefficient secondary market unit is assumed to be \$50. Therefore, where the new unit replaces an existing unit the measure cost is \$300 for ENERGY STAR or \$508 for CEE Tier 2, and where

¹¹⁴ ENERGY STAR Version 5.0 Room Air Conditioners Program Requirements

¹¹⁵ See DOE's Appliance and Equipment Standards for Room AC.

¹¹⁶ Measure Life Report, Residential and Commercial/Industrial Lighting and HVAC Measures, GDS Associates, June 2007.

¹¹⁷ Standard assumption of one third of effective useful life.

¹¹⁸ ENERGY STAR cost based on field study conducted by Efficiency Vermont and Tier 2 based on Efficiency Vermont's characterization of the NEEP Mid-Atlantic TRM's (version 9.0, October 2019) incremental cost analysis. See 'room-ac-cost-analysis-10.2023.xlsx.'

¹¹⁹ ENERGY STAR based on IL PHA Efficient Living Program Data for 810 replaced units showing \$416 per unit plus \$32 average recycling/removal cost. Differential in cost for the CEE Tiers is \$221, therefore CEE Tier 2 is \$448 + 221 = \$669.

¹²⁰ Estimate based upon Time of Sale incremental costs and applying inflation rate of 1.91%.

¹²¹ To promote improved cost effectiveness, it is assumed that the lower cost ENERGY STAR Room AC units would be used. Units between \$200-\$400 are available dependent on capacity.

there is no existing unit the measure cost is assumed to be \$250 for ENERGY STAR or \$458 for CEE Tier 2.

The avoided replacement cost (after 6 years) of the replacement secondary market unit is \$50. This cost should be discounted to present value using the nominal societal discount rate.

LOADSHAPE

Loadshape R08 - Residential Cooling

COINCIDENCE FACTOR

For non-IQ participants, the coincidence factor for this measure is assumed to be 0.3.¹²²

For Income Qualified units, where use is likely to be more consistent with central cooling, the summer peak coincidence factor is provided in two different ways below. The first is used to estimate peak savings during the utility peak hour and is most indicative of actual peak benefits, and the second represents the *average* savings over the defined summer peak period and is presented so that savings can be bid into PJM’s capacity market.

CF_{SSP} = Summer System Peak Coincidence Factor for Central A/C (during system peak hour)
 = 68%¹²³

CF_{PJM} = PJM Summer Peak Coincidence Factor for Central A/C (average during PJM peak period)
 = 46.6%¹²⁴

Algorithm

CALCULATION OF SAVINGS

ELECTRIC ENERGY SAVINGS

Non-IQ Participants:

Time of Sale: $\Delta kWh = (FLH_{RoomAC} * Btu/H * (1/CEER_{base} - 1/CEER_{ee}))/1000$

Early Replacment:

ΔkWh for remaining life of existing unit (1st 4 years) = $(FLH_{RoomAC} * Btu/H * (1/(EER_{exist}/1.01) - 1/CEER_{ee}))/1000$

ΔkWh for remaining measure life (next 8 years) = $(FLH_{RoomAC} * Btu/H * (1/CEER_{base} - 1/CEER_{ee}))/1000$

Where:

FLH_{RoomAC} = Full Load Hours of room air conditioning unit
 = dependent on location:¹²⁵

¹²² Consistent with coincidence factors found in: RLW Report: Final Report Coincidence Factor Study Residential Room Air Conditioners, June 23, 2008.

¹²³ Based on metering of 24 homes with central AC during PY4 and PY5 in Ameren Illinois service territory.

¹²⁴ Based on analysis of Itron eShape data for Missouri, calibrated to Illinois loads, supplied by Ameren. The average AC load over the PJM peak period (1-5pm, M-F, June through August) is divided by the maximum AC load during the year.

¹²⁵ Full load hours for room AC is significantly lower than for central AC. The average ratio of FLH for Room AC (provided in RLW Report: Final Report Coincidence Factor Study Residential Room Air Conditioners, June 23, 2008) to FLH for Central Cooling for the same location is 31%. This ratio is applied to those IL cities that have FLH for Central Cooling provided in the ENERGY STAR calculator. For other cities this is extrapolated using the FLH assumptions VEIC have developed for Central AC. There is a county mapping table in Volume 1, Section 3.7 providing the appropriate city to use for each county of Illinois.

Climate Zone (City based upon)	FLH _{RoomAC}
1 (Rockford)	235
2 (Chicago)	261
3 (Springfield)	340
4 (Belleville)	447
5 (Marion)	396
Weighted Average ¹²⁶	
ComEd	256
Ameren	364
Statewide	286

- Btu/H = Size of rebated unit
 = Actual. If unknown assume 8500 Btu/hr¹²⁷
- EERexist = Efficiency of existing unit
 = Actual. If unknown assume 7.7¹²⁸
- 1.01 = Factor to convert EER to CEER (CEER includes standby and off power consumption)¹²⁹
- CEERbase = Combined Energy Efficiency Ratio of baseline unit
 = As provided in tables above
- CEERee = Combined Energy Efficiency Ratio of CEE Tier 1 or ENERGY STAR unit
 = Actual. If unknown, assume minimum qualifying standard as provided in tables above

Time of Sale:
For example, for an 8,500 Btu/H capacity unit, with louvered sides, in an unknown location:

$$\Delta\text{kWh}_{\text{ENERGY STAR}} = (286 * 8500 * (1/10.9 - 1/14.7)) / 1000$$

$$= 57.7 \text{ kWh}$$

Early Replacement:
For example, a 7.7EER, 9000Btu/h unit is removed from a home in Springfield and replaced with an ENERGY STAR unit with louvered sides:

$$\Delta\text{kWh for remaining life of existing unit (1st 4 years) = (340 * 9000 * (1/(7.7/1.01) - 1/14.7))/1000$$

$$= 193.2 \text{ kWh}$$

$$\Delta\text{kWh for remaining measure life (next 8 years) = (340 * 9000 * (1/10.9 - 1/14.7))/1000$$

$$= 72.6 \text{ kWh}$$

¹²⁶ Weighting for Ameren is based on electric accounts in each of the cooling zones. Weighting for ComEd and Statewide average is based on number of occupied residential housing units in each zone. ComEd is weighted average of Zones 1-2. Alternative program-weighted assumptions can be used if appropriate.

¹²⁷ Based on maximum capacity average from the RLW Report: Final Report Coincidence Factor Study Residential Room Air Conditioners, June 23, 2008

¹²⁸ Based on Nexus Market Research Inc, RLW Analytics, December 2005; "Impact, Process, and Market Study of the Connecticut Appliance Retirement Program: Overall Report."

¹²⁹ Since the existing unit will be rated in EER, this factor is used to appropriately compare with the new CEER rating. Version 3.0 of the ENERGY STAR specification provided equivalent EER and CEER ratings and for the most popular size band the EER rating is approximately 1% higher than the CEER. See 'ENERGY STAR Version 3.0 Room Air Conditioners Program Requirements'.

Income Qualified Participants:

$$\Delta\text{kWh} = (\text{FLH}_{\text{RoomAC}} * \text{Btu/H} * (1/(\text{EER}_{\text{base}}/1.01) - 1/\text{CEER}_{\text{ee}}))/1000$$

Where:

$\text{FLH}_{\text{RoomAC}}$ = Full Load Hours of room air conditioning unit
 = dependent on location^{130 131};

Climate Zone (City based upon)	FLHcool (single family)	FLHcool (multifamily)	FLH_cooling (weatherized multifamily) <small>132</small>
1 (Rockford)	547	499	320
2 (Chicago)	709	629	403
3 (Springfield)	779	707	453
4 (Belleville)	1082	982	630
5 (Marion/ Murphysboro)	956	868	557
Weighted Average ¹³³			
ComEd	676	603	386
Ameren	875	791	507
Statewide	731	655	420

Btu/H = Size of installed unit
 = Actual. If unknown assume 8500 Btu/hr¹³⁴

EERbase =Efficiency of existing / baseline unit
 = Actual. If unknown assume 7.7 ¹³⁵

1.01 = Factor to convert EER to CEER (CEER includes standby and off power consumption)¹³⁶

¹³⁰ Full load hours for Chicago, Moline and Rockford are provided in “Final Evaluation Report: Central Air Conditioning Efficiency Services (CACES), 2010, Navigant Consulting”, p.33. An average FLH/Cooling Degree Day (from NCDC) ratio was calculated for these locations and applied to the CDD of the other locations in order to estimate FLH. There is a county mapping table in Volume 1, Section 3.7 providing the appropriate city to use for each county of Illinois. Note, full load hours for IQ homes are estimated to be higher than non-IQ homes and are assumed consistent with the Central AC FLH assumption. In a non-IQ home, it is expected that there be multiple Room AC units, many in bedrooms, and therefore the usage for each one would likely be lower. However in an IQ home it is assumed that the Room AC is being used as the main cooling system for the home are run more like a CAC.

¹³¹ Applied percent change of CDD65, NCEI Annual Normals from 30 yr data set (1981-2010) to more recent 15 yr data (2006-2020) to all FLHcool values.

¹³² *All-Electric Homes PY6 Metering Results: Multifamily HVAC Systems*, Cadmus, October 2015. The multifamily units within this study had undergone significant shell improvements (air sealing and insulation) and therefore this set of assumptions is only appropriate for units that have recently participated in a weatherization or other shell program. Note that the FLHcool where recalculated based on existing efficiencies consistent with the TRM rather than from the metering study.

¹³³ Weighting for Ameren is based on electric accounts in each of the cooling zones. Weighting for ComEd and Statewide average is based on number of occupied residential housing units in each zone. ComEd is weighted average of Zones 1-2. Alternative program-weighted assumptions can be used if appropriate.

¹³⁴ Based on maximum capacity average from the RLW Report: Final Report Coincidence Factor Study Residential Room Air Conditioners, June 23, 2008

¹³⁵ Based on Nexus Market Research Inc, RLW Analytics, December 2005; “Impact, Process, and Market Study of the Connecticut Appliance Retirement Program: Overall Report.”

¹³⁶ Since the existing unit will be rated in EER, this factor is used to appropriately compare with the new CEER rating. Version 3.0 of the ENERGY STAR specification provided equivalent EER and CEER ratings and for the most popular size band the EER rating is approximately 1% higher than the CEER. See ‘ENERGY STAR Version 3.0 Room Air Conditioners Program Requirements’.

CEER_{ee} = Combined Energy Efficiency Ratio of ENERGY STAR unit
 = Actual. If unknown assume minimum qualifying standard as provided in tables above

For Example, for an 8,500 Btu/H capacity unit, with louvered sides, in an unknown multifamily location:

$$\Delta kWh_{ENERGYSTAR} = (655 * 8500 * (1 / (7.7 / 1.01) - 1 / 14.7)) / 1000$$

$$= 352 \text{ kWh}$$

SUMMER COINCIDENT PEAK DEMAND SAVINGS

Non-IQ Participants:

Time of Sale: $\Delta kW = Btu/H * ((1/(CEER_{base} * 1.01) - 1/(CEER_{ee} * 1.01)))/1000) * CF$

Early Replacement: $\Delta kW = Btu/H * ((1/EER_{exist} - 1/(CEER_{ee} * 1.01)))/1000) * CF$

Where:

CF = Summer Peak Coincidence Factor for measure
 = 0.3¹³⁷

1.01 = Factor to convert CEER to EER (CEER includes standby and off power consumption)¹³⁸
 Other variable as defined above

Time of Sale:

For example, for an 8,500 Btu/H capacity unit, with louvered sides, for an unknown location:

$$\Delta kW_{ENERGYSTAR} = ((8500 * (1/(10.9 * 1.01) - 1/(14.7 * 1.01)))/1000) * 0.3$$

$$= 0.060 \text{ kW}$$

Early Replacement:

For example, a 7.7 EER, 9000Btu/h unit is removed from a home in Springfield and replaced with an ENERGY STAR unit with louvered sides:

$$\Delta kW \text{ for remaining life of existing unit (1}^{st} \text{ 4 years)} = ((9000 * (1/7.7 - 1/(14.7 * 1.01)))/1000) * 0.3$$

$$= 0.169 \text{ kW}$$

$$\Delta kW \text{ for remaining measure life (next 8 years)} = ((9000 * (1/(10.9 * 1.01) - 1/(14.7 * 1.01)))/1000) * 0.3$$

$$= 0.063 \text{ kW}$$

IQ Participants:

$$\Delta kW = Btu/H * ((1/EER_{exist} - 1/(CEER_{ee} * 1.01)))/1000) * CF$$

Where:

CF_{SSP} = Summer System Peak Coincidence Factor for Central A/C (during system peak hour)

¹³⁷ Consistent with coincidence factors found in: RLW Report: Final Report Coincidence Factor Study Residential Room Air Conditioners, June 23, 2008

¹³⁸ Since the new CEER rating includes standby and off power consumption, for peak calculations it is more appropriate to apply the EER rating, but it appears as though new units will only be rated with a CEER rating. Version 3.0 of the ENERGY STAR specification provided equivalent EER and CEER ratings and for the most popular size band the EER rating is approximately 1% higher than the CEER. See 'ENERGY STAR Version 3.0 Room Air Conditioners Program Requirements'.

	= 68% ¹³⁹
CF _{PJM}	= PJM Summer Peak Coincidence Factor for Central A/C (average during PJM peak period) = 46.6% ¹⁴⁰
1.02	= Factor to convert CEER to EER (CEER includes standby and off power consumption) ¹⁴¹ Other variable as defined above

For Example, for an 8,500 Btu/H capacity unit, with louvered sides, for an unknown multifamily location:

$$\begin{aligned} \Delta kW_{SSP} &= (8500 * (1/7.7 - 1/(14.7*1.01))) / 1000 * 0.68 \\ &= 0.3613 \text{ kW} \end{aligned}$$

$$\begin{aligned} \Delta kW_{PJM} &= (8500 * (1/7.7 - 1/(14.7*1.01))) / 1000 * 0.466 \\ &= 0.2476 \text{ kW} \end{aligned}$$

FOSSIL FUEL SAVINGS

N/A

WATER IMPACT DESCRIPTIONS AND CALCULATION

N/A

DEEMED O&M COST ADJUSTMENT CALCULATION

N/A

MEASURE CODE: RS-APL-ESRA-V11-250101

REVIEW DEADLINE: 1/1/2028

¹³⁹ Based on metering of 24 homes with central AC during PY4 and PY5 in Ameren Illinois service territory.

¹⁴⁰ Based on analysis of Itron eShape data for Missouri, calibrated to Illinois loads, supplied by Ameren. The average AC load over the PJM peak period (1-5pm, M-F, June through August) is divided by the maximum AC load during the year.

¹⁴¹ Since the new CEER rating includes standby and off power consumption, for peak calculations it is more appropriate to apply the EER rating, but it appears as though new units will only be rated with a CEER rating. Version 3.0 of the ENERGY STAR specification provided equivalent EER and CEER ratings and for the most popular size band the EER rating is approximately 1% higher than the CEER. See 'ENERGY STAR Version 3.0 Room Air Conditioners Program Requirements'.

5.1.8 Refrigerator and Freezer Recycling

DESCRIPTION

This measure describes savings from the retirement and recycling of inefficient but operational refrigerators and freezers. Savings are provided based on a 2013 workpaper provided by Cadmus that used data from a 2012 ComEd metering study and metering data from a Michigan study, to develop a regression equation that uses key inputs describing the retired unit. The savings are equivalent to the Unit Energy Consumption of the retired unit and should be claimed for the assumed remaining useful life of that unit. A part use factor is applied to account for those secondary units that are not in use throughout the entire year. The reader should note that the regression algorithm is designed to provide an accurate portrayal of savings for the population as a whole and includes those parameters that have a significant effect on the consumption. The precision of savings for individual units will vary.

For Net to Gross factor considerations, please refer to section 4.2 Appliance Recycling Protocol of Appendix A: Illinois Statewide Net-to-Gross Methodologies of Volume 4.0 Cross Cutting Measures and Attachments.

This measure was developed to be applicable to the following program types: ERET.

If applied to other program types, the measure savings should be verified.

DEFINITION OF EFFICIENT EQUIPMENT

N/A

DEFINITION OF BASELINE EQUIPMENT

The existing inefficient unit must be operational and have a capacity of between 10 and 30 cubic feet.

DEEMED LIFETIME OF EFFICIENT EQUIPMENT

The estimated remaining useful life of the recycling units is 6.5 years.¹⁴²

DEEMED MEASURE COST

Measure cost includes the customer's value placed on their lost amenity, any customer transaction costs, and the cost of pickup and recycling of the refrigerator/freezer and should be based on actual costs of running the program. The payment (bounty) a Program Administrator makes to the customer serves as a proxy for the value the customer places on their lost amenity and any customer transaction costs. If unknown assume \$170 per unit.¹⁴³

LOADSHAPE

Loadshape R05 - Residential Refrigerator

COINCIDENCE FACTOR

The coincidence factor is assumed 1.081 for Refrigerators and 1.028 for Freezers¹⁴⁴.

¹⁴² DOE refrigerator and freezer survival curves are used to calculate RUL for each equipment age and develop a RUL schedule. The RUL of each unit in the ARCA database is calculated and the average RUL of the dataset serves as the final measure RUL. Refrigerator recycling data from ComEd (PY7-PY9) and Ameren (PY6-PY8) were used to determine EUL with the DOE survival curves from the 2009 TSD. A weighted average of the retailer ComEd data and the Ameren data results in an average of 6.5 years. See Navigant 'ComEd Effective Useful Life Research Report', May 2018.

¹⁴³ The \$170 default assumption is based on \$120 cost of pickup and recycling per unit and \$50 proxy for customer transaction costs and value customer places on their lost amenity. \$120 is cost of pickup and recycling based on similar Efficiency Vermont program. \$50 is bounty, based on Ameren and ComEd program offerings as of 7/27/15.

¹⁴⁴ Cadmus memo, February 12, 2013; "Appliance Recycling Update"

Algorithm

CALCULATION OF SAVINGS

ENERGY SAVINGS¹⁴⁵

Refrigerators:

Energy savings for refrigerators are based upon a linear regression model using the following coefficients:¹⁴⁶

Independent Variable Description	Estimate Coefficient
Intercept	83.324
Age (years)	3.678
Pre-1990 (=1 if manufactured pre-1990)	485.037
Size (cubic feet)	27.149
Dummy: Side-by-Side (= 1 if side-by-side)	406.779
Dummy: Primary Usage Type (in absence of the program) (= 1 if primary unit)	161.857
Interaction: Located in Unconditioned Space x CDD/365.25	15.366
Interaction: Located in Unconditioned Space x HDD/365.25	-11.067

$$\Delta kWh = [83.32 + (Age * 3.68) + (Pre-1990 * 485.04) + (Size * 27.15) + (Side-by-side * 406.78) + (Proportion of Primary Appliances * 161.86) + (CDD/365.25 * unconditioned * 15.37) + (HDD/365.25 * unconditioned * -11.07)] * Part Use Factor$$

Where:

- Age = Age of retired unit
- Pre-1990 = Pre-1990 dummy (=1 if manufactured pre-1990, else 0)
- Size = Capacity (cubic feet) of retired unit
- Side-by-side = Side-by-side dummy (= 1 if side-by-side, else 0)
- Primary Usage = Primary Usage Type (in absence of the program) dummy
(= 1 if Primary, else 0)

- Interaction: Located in Unconditioned Space x CDD/365.25
(=1 * CDD/365.25 if in unconditioned space)
- CDD = Cooling Degree Days
= Dependent on location:¹⁴⁷

Climate Zone (City based upon)	CDD 65	CDD/365.25
1 (Rockford)	877	2.40

¹⁴⁵ Based on the specified regression, a small number of units may have negative energy and demand consumption. These are a function of the unit size and age, and should comprise a very small fraction of the population. While on an individual basis this result is counterintuitive it is important that these negative results remain such that as a population the average savings is appropriate.

¹⁴⁶ Energy savings are based on an average 30-year TMY temperature of 51.1 degrees. Coefficients provided in July 30, 2014 memo from Cadmus: "Appliance Recycling Update no single door July 30, 2014".

¹⁴⁷ National Centers for Environmental Information (NCEI) Annual Normals, from 2006 - 2020, calculated with a base temp of 65°F.

Climate Zone (City based upon)	CDD 65	CDD/365.25
2 (Chicago)	1047	2.87
3 (Springfield)	1183	3.24
4 (Belleville)	1641	4.49
5 (Marion/Murphysboro)	1450	3.97

Interaction: Located in Unconditioned Space x HDD/365.25

(=1 * HDD/365.25 if in unconditioned space)

HDD = Heating Degree Days

= Dependent on location:¹⁴⁸

Climate Zone (City based upon)	HDD 65	HDD/365.25
1 (Rockford)	6414	17.56
2 (Chicago)	5963	16.33
3 (Springfield)	5368	14.70
4 (Belleville)	4162	11.39
5 (Marion/Murphysboro)	4413	12.08

Part Use Factor = To account for those units that are not running throughout the entire year. The most recent part-use factor participant survey results available at the start of the current program year shall be used.¹⁴⁹ For illustration purposes, this example uses 0.93.¹⁵⁰

For example, the program averages for AIC’s ARP in PY4 produce the following equation:

$$\begin{aligned} \Delta kWh &= [83.32 + (22.81 * 3.68) + (0.45 * 485.04) + (18.82 * 27.15) + (0.17 * 406.78) \\ &+ (0.34 * 161.86) + (1.29 * 15.37) + (6.49 * -11.07)] * 0.93 \\ &= 969 * 0.93 \\ &= 900.9 kWh \end{aligned}$$

Freezers:

Energy savings for freezers are based upon a linear regression model using the following coefficients:¹⁵¹

Independent Variable Description	Estimate Coefficient
Intercept	132.122
Age (years)	12.130
Pre-1990 (=1 if manufactured pre-1990)	156.181
Size (cubic feet)	31.839
Chest Freezer Configuration (=1 if chest freezer)	-19.709
Interaction: Located in Unconditioned Space x	9.778

¹⁴⁸ National Climatic Data Center, calculated from 1981-2010 climate normals with a base temp of 65°F.

¹⁴⁹ For example, the part-use factor that shall be applied to the current program year t (PYt) for savings verification purposes should be determined through the PYt-2 participant surveys conducted in the respective utility’s service territory, if available. If an evaluation was not performed in PYt-2 the latest available evaluation should be used.

¹⁵⁰ Most recent refrigerator part-use factor from Ameren Illinois PY5 evaluation.

¹⁵¹ Energy savings are based on an average 30-year TMY temperature of 51.1 degrees. Coefficients provided in January 31, 2013 memo from Cadmus: “Appliance Recycling Update”.

Independent Variable Description	Estimate Coefficient
CDD/365.25	
Interaction: Located in Unconditioned Space x HDD/365.25	-12.755

$$\Delta kWh = [132.12 + (\text{Age} * 12.13) + (\text{Pre-1990} * 156.18) + (\text{Size} * 31.84) + (\text{Chest Freezer} * -19.71) + (\text{CDDs} * \text{unconditioned} * 9.78) + (\text{HDDs} * \text{unconditioned} * -12.75)] * \text{Part Use Factor}$$

Where:

Age = Age of retired unit

Pre-1990 = Pre-1990 dummy (=1 if manufactured pre-1990, else 0)

Size = Capacity (cubic feet) of retired unit

Chest Freezer = Chest Freezer dummy (= 1 if chest freezer, else 0)

Interaction: Located in Unconditioned Space x CDD/365.25

(=1 * CDD/365.25 if in unconditioned space)

CDD = Cooling Degree Days (see table above)

Interaction: Located in Unconditioned Space x HDD/365.25

(=1 * HDD/365.25 if in unconditioned space)

HDD = Heating Degree Days (see table above)

Part Use Factor = To account for those units that are not running throughout the entire year. The most recent part-use factor participant survey results available at the start of the current program year shall be used.¹⁵² For illustration purposes, the example uses 0.85.¹⁵³

For example, the program averages for AIC’s ARP in PY4 produce the following equation:

$$\begin{aligned} \Delta kWh &= [132.12 + (26.92 * 12.13) + (0.6 * 156.18) + (15.9 * 31.84) + (0.48 * -19.71) \\ &\quad + (6.61 * 9.78) + (1.3 * -12.75)] * 0.825 \\ &= 977 * 0.825 \\ &= 905 kWh \end{aligned}$$

SUMMER COINCIDENT PEAK DEMAND SAVINGS

$$\Delta kW = kWh/8766 * CF$$

Where:

kWh = Savings provided in algorithm above

CF = Coincident factor defined as summer kW/average kW

= 1.081 for Refrigerators

= 1.028 for Freezers¹⁵⁴

¹⁵² For example, the part-use factor that shall be applied to the current program year t (PYt) for savings verification purposes should be determined through the PYt-2 participant surveys conducted in the respective utility’s service territory, if available. If an evaluation was not performed in PYt-2 the latest available evaluation should be used.

¹⁵³ Most recent freezer part-use factor from Ameren Illinois Company PY5 evaluation.

¹⁵⁴ Cadmus memo, February 12, 2013; “Appliance Recycling Update”

For example, the program averages for AIC’s ARP in PY4 produce the following equation:

$$\begin{aligned}\Delta kW &= 806/8766 * 1.081 \\ &= 0.099 \text{ kW}\end{aligned}$$

FOSSIL FUEL SAVINGS

N/A

WATER IMPACT DESCRIPTIONS AND CALCULATION

N/A

DEEMED O&M COST ADJUSTMENT CALCULATION

N/A

MEASURE CODE: RS-APL-RFRC-V09-240101

REVIEW DEADLINE:

Note: No active programs utilizing this measure in IL as of 2023. Reliability update is required if measure if to be taken up again.

5.1.9 Room Air Conditioner Recycling

DESCRIPTION

This measure describes the savings resulting from running a drop off service taking existing residential, inefficient Room Air Conditioner units from service, prior to their natural end of life. This measure assumes that though a percentage of these units will be replaced this is not captured in the savings algorithm since it is unlikely that the incentive made someone retire a unit that they weren't already planning to retire. The savings therefore relate to the unit being taken off the grid as opposed to entering the secondary market. The Net to Gross factor applied to these units should incorporate adjustments that account for those participants who would have removed the unit from the grid anyway.

This measure was developed to be applicable to the following program types: ERET. If applied to other program types, the measure savings should be verified.

DEFINITION OF EFFICIENT EQUIPMENT

N/A. This measure relates to the retiring of an existing inefficient unit.

DEFINITION OF BASELINE EQUIPMENT

The baseline condition is the existing inefficient room air conditioning unit.

DEEMED LIFETIME OF EFFICIENT EQUIPMENT

The assumed remaining useful life of the existing room air conditioning unit being retired is 4 years.¹⁵⁵

DEEMED MEASURE COST

The actual implementation cost for recycling the existing unit should be used.

LOADSHAPE

Loadshape R08 - Residential Cooling

COINCIDENCE FACTOR

The coincidence factor for this measure is assumed to be 30%.¹⁵⁶

Algorithm

CALCULATION OF SAVINGS

ELECTRIC ENERGY SAVINGS

$$\Delta kWh = ((FLH_{RoomAC} * Btu/hr * (1/EER_{exist}))/1000)$$

Where:

FLH_{RoomAC} = Full Load Hours of room air conditioning unit
 = dependent on location:¹⁵⁷

¹⁵⁵ A third of assumed measure life for Room AC.

¹⁵⁶ Consistent with coincidence factors found in: RLW Report: Final Report Coincidence Factor Study Residential Room Air Conditioners, June 23, 2008.

¹⁵⁷ Full load hours for room AC is significantly lower than for central AC. The average ratio of FLH for Room AC (provided in RLW Report: Final Report Coincidence Factor Study Residential Room Air Conditioners, June 23, 2008) to FLH for Central Cooling for

Climate Zone (City based upon)	FLH _{RoomAC}
1 (Rockford)	235
2 (Chicago)	261
3 (Springfield)	340
4 (Belleville)	447
5 (Marion)	396
Weighted Average ¹⁵⁸	
ComEd	256
Ameren	364
Statewide	286

Btu/H = Size of retired unit
 = Actual. If unknown assume 8500 Btu/hr ¹⁵⁹

EERexist = Efficiency of existing unit
 = 9.8¹⁶⁰

For example, for an 8500 Btu/h unit in Springfield:

$$\Delta kWh = ((340 * 8500 * (1/9.8)) / 1000)$$

$$= 295 \text{ kWh}$$

SUMMER COINCIDENT PEAK DEMAND SAVINGS

$$\Delta kW = (\text{Btu/hr} * (1/\text{EERexist}))/1000 * \text{CF}$$

Where:

CF = Summer Peak Coincidence Factor for measure
 = 0.3¹⁶¹

For example, an 8500 Btu/h unit:

$$\Delta kW = (8500 * (1/9.8)) / 1000 * 0.3$$

$$= 0.26 \text{ kW}$$

FOSSIL FUEL SAVINGS

N/A

the same location is 31%. This ratio is applied to those IL cities that have FLH for Central Cooling provided in the ENERGY STAR calculator. For other cities this is extrapolated using the FLH assumptions VEIC have developed for Central AC. There is a county mapping table in Volume 1, Section 3.7 providing the appropriate city to use for each county of Illinois.

¹⁵⁸ Weighting for Ameren is based on electric accounts in each of the cooling zones. Weighting for ComEd and Statewide average is based on number of occupied residential housing units in each zone. ComEd is weighted average of Zones 1-2. Alternative program-weighted assumptions can be used if appropriate.

¹⁵⁹ Based on maximum capacity average from the RLW Report: Final Report Coincidence Factor Study Residential Room Air Conditioners, June 23, 2008

¹⁶⁰ Minimum Federal Standard for most common room AC type (8000-14,999 capacity range with louvered sides) per federal standards from 10/1/2000 to 5/31/2014. Note that this value is the EER value, as CEER were introduced later.

¹⁶¹ Consistent with coincidence factors found in:
 RLW Report: Final Report Coincidence Factor Study Residential Room Air Conditioners, June 23, 2008.

WATER IMPACT DESCRIPTIONS AND CALCULATION

N/A

DEEMED O&M COST ADJUSTMENT CALCULATION

N/A

MEASURE CODE: RS-APL-RARC-V04-240101

REVIEW DEADLINE: 1/1/2025

5.1.10 ENERGY STAR Clothes Dryer

DESCRIPTION

This measure relates to the installation of a residential clothes dryer meeting the ENERGY STAR criteria. ENERGY STAR qualified clothes dryers save energy through a combination of more efficient drying and reduced runtime of the drying cycle. More efficient drying is achieved through heat pump technology, increased insulation, modifying operating conditions such as air flow and/or heat input rate, improving air circulation through better drum design or booster fans, and improving efficiency of motors. Reducing the runtime of dryers through automatic termination by temperature and moisture sensors is believed to have the greatest potential for reducing energy use in clothes dryers¹⁶². ENERGY STAR provides criteria for both gas and electric clothes dryers.

This measure was developed to be applicable to the following program types: TOS, NC. If applied to other program types, the measure savings should be verified.

DEFINITION OF EFFICIENT EQUIPMENT

Clothes dryer must meet the ENERGY STAR or ENERGY STAR Most Efficient criteria, as required by the program. Units utilizing the Heat Pump designation must meet the same ENERGY STAR criteria and be classified as Heat Pump or Hybrid Heat Pump units.

DEFINITION OF BASELINE EQUIPMENT

The baseline condition is a clothes dryer meeting the minimum federal requirements for units manufactured on or after January 1, 2015. Note that the DOE Federal Standards utilize the Appendix D1 testing procedure whereas the ENERGY STAR specifications use the Appendix D2 test. In order to compare relative efficiencies, this measure uses adjusted baseline CEF values that were developed by ENERGY STAR to convert CEF-D1 values in to equivalent CEF-D2 values.

DEEMED LIFETIME OF EFFICIENT EQUIPMENT

The expected measure life is assumed to be 16 years.¹⁶³

DEEMED MEASURE COST

For non-IQ participants, the incremental cost for an ENERGY STAR clothes dryer is assumed to be \$152 and \$405 for an ENERGY STAR Most Efficient dryer.¹⁶⁴

For IQ participants, the incremental cost for an ENERGY STAR clothes dryer is assumed to be \$246 and \$499 for an ENERGY STAR Most Efficient dryer.¹⁶⁵

LOADSHAPE

Loadshape R17 - Residential Electric Dryer

COINCIDENCE FACTOR

The coincidence factor for this measure is 3.8%.¹⁶⁶

¹⁶² ENERGY STAR Market & Industry Scoping Report. Residential Clothes Dryers. Table 8. November 2011.

¹⁶³ Based on DOE Rulemaking Technical Support Document, LCC Chapter, 2011, as recommended in Navigant 'ComEd Effective Useful Life Research Report', May 2018.

¹⁶⁴ Based on the difference in installed cost for an efficient dryer (\$716) and standard dryer (\$564) (see "ACEEE Clothes Dryers.pdf").

¹⁶⁵ IQ Incremental costs factor in the assumption that a secondhand unit costs on average 50% of a new baseline unit, and that 1/3 of IQ participants would have purchased a unit on the secondhand market. See "IQ Appliance Calculations.xls" for information.

¹⁶⁶ Based on coincidence factor of 3.8% for clothes washers

Algorithm

CALCULATION OF ENERGY SAVINGS

ELECTRIC ENERGY SAVINGS

Non Fuel Switch Measures

$$\Delta kWh = ((Load/CEFbase * IQAdj) - Load/CEFeff) * Ncycles * \%Electric$$

$$\Delta Therm = ((Load/CEFbase * IQAdj) - Load/CEFeff) * Ncycles * Therm_convert * \%Gas$$

Fuel Switch/Electrification Measures

Fuel switch / electrification measures must produce positive total energy savings (i.e., reduction in Btus at the premises) in order to qualify. This is determined as follows:

$$SiteEnergySavings \text{ (MMBTUs)} = [FuelSwitchSavings] + [NonFuelSwitchSavings]$$

$$FuelSwitchSavings = [((Load/CEFbase_{Gas} * IQAdj) * Ncycles * MMBtu_convert * \%Gas_{Gas}) - [Load/CEFeff_{Elec} * Ncycles * MMBtu_convert * \%Gas_{Gas}]]$$

$$NonFuelSwitchSavings = [((Load/CEFbase_{Gas} * IQAdj) * Ncycles * MMBtu_convert * \%Electric_{Gas}) - [Load/CEFeff_{Elec} * Ncycles * MMBtu_convert * \%Electric_{Gas}]]$$

If SiteEnergySavings calculated above is positive, the measure is eligible.

The appropriate savings claim is dependent on which utilities are supporting the measure as provided in a table below:

Measure supported by:	Electric Utility claims (kWh):	Gas Utility claims (therms):
Electric utility only	SiteEnergySavings * 1,000,000/3,412	N/A
Electric and gas utility (Note utilities may make alternative agreements to how savings are allocated as long as total MMBtu savings remains the same).	%IncentiveElectric * SiteEnergySavings * 1,000,000/3,412	%IncentiveGas * SiteEnergySavings * 10
Gas utility only	N/A	SiteEnergySavings * 10

Where:

Load = The average total weight (lbs) of clothes per drying cycle. If dryer size is unknown, assume standard.

Dryer Size	Load (lbs) ¹⁶⁷
Standard	8.45
Compact	3

CEFbase = Combined energy factor (CEF) (lbs/kWh) of the baseline unit is based on existing federal

¹⁶⁷ Based on ENERGY STAR test procedures.

standards energy factor and adjusted to CEF-D2 (equivalent to as if tested under Appendix D2) as performed in the ENERGY STAR analysis.¹⁶⁸ If product class unknown, assume electric, standard.

Product Class	CEF (lbs/kWh) under Appendix D2
Vented Electric, Standard ($\geq 4.4 \text{ ft}^3$)	3.11
Vented Electric, Compact (120V) ($< 4.4 \text{ ft}^3$)	3.01
Vented Electric, Compact (240V) ($< 4.4 \text{ ft}^3$)	2.73
Ventless Electric, Compact (240V) ($< 4.4 \text{ ft}^3$)	2.13
Vented Gas	2.84 ¹⁶⁹
Electric Heat Pump, Standard ($\geq 4.4 \text{ ft}^3$)	3.11
Electric Heat Pump, Compact (120V) ($< 4.4 \text{ ft}^3$)	3.01

IQAdj = Baseline consumption adjustment for IQ program participants to account for a portion of participants who would have utilized the secondary market.¹⁷⁰

= 1.033 if IQ, 1.0 if non-IQ

CEFeff = CEF (lbs/kWh) of the ENERGY STAR unit based on ENERGY STAR or ENERGY STAR Most Efficient requirements.¹⁷¹ If product class unknown, assume electric, standard.

Product Class	ENERGY STAR	ENERGY STAR Most Efficient
	CEF (lbs/kWh)	CEF (lbs/kWh)
Vented or Ventless Electric, Standard ($\geq 4.4 \text{ ft}^3$)	3.93	4.3
Vented or Ventless Electric, Compact (120V) ($< 4.4 \text{ ft}^3$)	3.80	4.3
Vented Electric, Compact (240V) ($< 4.4 \text{ ft}^3$)	3.45	4.3
Ventless Electric, Compact (240V) ($< 4.4 \text{ ft}^3$)	2.68	3.7
Vented Gas	3.48 ¹⁷²	3.8
Electric Heat Pump, Standard ($\geq 4.4 \text{ ft}^3$)	3.93	6.5 ¹⁷³
Electric Heat Pump, Compact ($< 4.4 \text{ ft}^3$)	3.36	6.2 ¹⁷⁴

¹⁶⁸ ENERGY STAR Draft 2 Version 1.0 Clothes Dryers Data and Analysis

¹⁶⁹ Federal standards report CEF for gas clothes dryers in terms of lbs/kWh. To determine gas savings, this number is later converted to therms.

¹⁷⁰ It is assumed that a second-hand unit is on average 2/3 of a measure’s EUL years old (11 years). The current Federal Standard became effective in 2015 so the previous standard is used to estimate base consumption for a second hand unit, and further increased by an estimate of 0.4% * 11 years (based on review of the refrigerator/freezer regression algorithm used in the 5.1.8 Refrigerator and Freezer Recycling measure) to account for degradation of performance over time. This second hand consumption was then weighted 1/3: 2/3 current new baseline to estimate a multiplier for IQ participants. See “IQ Appliance Calculations.xls” for information.

¹⁷¹ ENERGY STAR Clothes Dryers Key Product Criteria.

¹⁷² Federal standards report CEF for gas clothes dryers in terms of lbs/kWh. To determine gas savings, this number is later converted to therms.

¹⁷³ Average CEF of available standard ENERGY STAR Clothes Dryers with Heat Pump technology. EPA ENERGY STAR. May 2022. <https://www.energystar.gov/productfinder/product/certified-clothes-dryers/>.

¹⁷⁴ Average CEF of available compact ENERGY STAR Clothes Dryers with Heat Pump technology. EPA ENERGY STAR. May 2022. <https://www.energystar.gov/productfinder/product/certified-clothes-dryers/>.

Ncycles	= Number of dryer cycles per year. Use actual data if available. If unknown, use 259 cycles per year. ¹⁷⁵
%Electric	= The percent of overall savings coming from electricity = 100% for electric dryers, 16% for gas dryers ¹⁷⁶
Therm_convert	= Conversion factor from kWh to Therm = 0.03412
%Gas	= Percent of overall savings coming from gas = 0% for electric units and 84% for gas units ¹⁷⁷
MMBtu_convert	= Conversion factor from kWh to MMBtu = 0.003412

¹⁷⁵ Loads per week was estimated by taking the weighted average of the number of loads per week (midpoint used where loads per week is a range and the weights are the share of respondents falling into each number of loads per week response bin). This estimate was scaled to an IL-specific value by applying a ratio developed using the 2009 state specific values for the states in the East North Central portion of the Midwest Region. Reduced by 6% to maintain prior ratio of dryer to clothes washer loads of 94%.

¹⁷⁶ %Electric accounts for the fact that some of the savings on gas dryers comes from electricity (motors, controls, etc). 16% was determined using a ratio of the electric to total savings from gas dryers given by ENERGY STAR Draft 2 Version 1.0 Clothes Dryers Data and Analysis.

¹⁷⁷ %Gas accounts for the fact that some of the savings on gas dryers comes from electricity (motors, controls, etc). 84% was determined using a ratio of the gas to total savings from gas dryers given by ENERGY STAR Draft 2 Version 1.0 Clothes Dryers Data and Analysis.

Electric examples, for a non- IQ Time of Sale, standard, vented, electric ENERGY STAR clothes dryer:

$$\begin{aligned} \Delta kWh &= (((8.45/3.11 * 1) - 8.45/3.93) * 259 * 100\%) \\ &= 147 \text{ kWh} \end{aligned}$$

For an IQ Time of Sale, standard, vented, electric ENERGY STAR clothes dryer:

$$\begin{aligned} \Delta kWh &= (((8.45/3.11 * 1.033) - 8.45/3.93) * 259 * 100\%) \\ &= 170 \text{ kWh} \end{aligned}$$

Gas example, for a non-IQ Time of Sale, a standard, vented, gas ENERGY STAR clothes dryer:

$$\begin{aligned} \Delta \text{Therm} &= ((8.45/2.84 * 1) - 8.45/3.48) * 259 * 0.03412 * 0.84 \\ &= 4.06 \text{ therms} \end{aligned}$$

$$\begin{aligned} \Delta kWh &= (((8.45/2.84 * 1) - 8.45/3.48) * 259 * 0.16) \\ &= 22.7 \text{ kWh} \end{aligned}$$

Fuel switch example, for a non-IQ Time of Sale, ENERGYSTAR Most Efficient Heat Pump clothes dryer in place of a baseline gas dryer:

$$\begin{aligned} \text{SiteEnergySavings (MMBTUs)} &= [\text{FuelSwitchSavings}] + [\text{NonFuelSwitchSavings}] \\ \text{FuelSwitchSavings} &= [((\text{Load}/\text{CEF}_{\text{baseGas}} * \text{IQAdj}) * \text{Ncycles} * \text{MMBtu_convert} * \% \text{Gas}_{\text{Gas}}) - [\text{Load}/\text{CEFF}_{\text{Elec}} * \text{Ncycles} * \text{MMBtu_convert} * \% \text{Gas}_{\text{Gas}}]] \\ &= ((8.45/2.84 * 1) * 259 * 0.003412 * 0.84) - (8.45/5.7 * 259 * 0.003412 * 0.84) \\ &= 1.11 \text{ MMBtu} \end{aligned}$$

$$\begin{aligned} \text{NonFuelSwitchSavings} &= [((\text{Load}/\text{CEF}_{\text{baseGas}} * \text{IQAdj}) * \text{Ncycles} * \text{MMBtu_convert} * \% \text{Electric}_{\text{Gas}}) - [\text{Load}/\text{CEFF}_{\text{Elec}} * \text{Ncycles} * \text{MMBtu_convert} * \% \text{Electric}_{\text{Gas}}]] \\ &= ((8.45/2.84 * 1) * 259 * 0.003412 * 0.16) - (8.45/5.7 * 259 * 0.003412 * 0.16) \\ &= 0.21 \text{ MMBtu} \end{aligned}$$

$$\begin{aligned} \text{SiteEnergySavings (MMBTUs)} &= 1.11 + 0.21 \\ &= 1.32 \text{ MMBtu} \end{aligned}$$

$$\begin{aligned} \text{If supported by an electric utility: } \Delta kWh &= \Delta \text{SiteEnergySavings} * 1,000,000 / 3,412 \\ &= 1.32 * 1,000,000/3412 \\ &= 386.9 \text{ kWh} \end{aligned}$$

SUMMER COINCIDENT PEAK DEMAND SAVINGS

For non-fuel switch measures:

$$\Delta kW = (((\text{Load}/\text{CEF}_{\text{base}} * \text{IQAdj}) - \text{Load}/\text{CEFF}_{\text{eff}}) * \text{Ncycles} * \% \text{Electric}) / \text{Hours} * \text{CF}$$

For fuel switch measures:

$$\Delta kW = \left(\left[\frac{\text{Load}}{\text{CEff}_{\text{Gas}}} * \text{IQAdj} \right] * \text{Ncycles} * \% \text{Electric}_{\text{Gas}} \right) - \left[\frac{\text{Load}}{\text{CEff}_{\text{Elec}}} * \text{Ncycles} * \% \text{Electric}_{\text{Electric}} \right] / \text{Hours} * \text{CF}$$

Where:

- Hours = Annual run hours of clothes dryer. Use actual data if available. If unknown, use 259 hours per year.¹⁷⁸
- CF = Summer Peak Coincidence Factor for measure
= 3.8%¹⁷⁹

For example, for a non-IQ Time of Sale, standard, vented, electric ENERGY STAR clothes dryer:

$$\begin{aligned} \Delta kW &= \left(\left(\left(\frac{8.45}{3.11} * 1 \right) - \frac{8.45}{3.93} \right) * 259 * 100\% \right) / 259 * 3.8\% \\ &= 0.0215 \text{ kW} \end{aligned}$$

FOSSIL FUEL SAVINGS

Calculation provided together with Electric Energy Savings above.

WATER IMPACT DESCRIPTIONS AND CALCULATION

N/A

DEEMED O&M COST ADJUSTMENT CALCULATION

N/A

COST EFFECTIVENESS SCREENING AND LOAD REDUCTION FORECASTING WHEN FUEL SWITCHING

This measure can involve fuel switching from fossil fuel to electric.

For the purposes of forecasting load reductions due to fuel switch projects per Section 16-111.5B, changes in site energy use at the customer’s meter (using ΔkWh algorithm below) adjusted for utility line losses (at-the-busbar savings), customer switching estimates, NTG, and any other adjustment factors deemed appropriate, should be used.

The inputs to cost effectiveness screening should reflect the actual impacts on the electric and fuel consumption at the customer meter and, for fuel switching measures, this will not match the output of the calculation/allocation methodology presented in the “Electric Energy Savings” and “Fossil Fuel Savings” sections above. Therefore in addition to the calculation of savings claimed, the following values should be used to assess the cost effectiveness of the measure.

$$\begin{aligned} \Delta \text{Therms} &= [\text{Gas Dryer Consumption Replaced}] \\ &= \left[\left(\frac{\text{Load}}{\text{CEF}_{\text{baseGas}}} * \text{IQAdj} \right) * \text{Ncycles} * \text{Therm_convert} * \% \text{Gas}_{\text{Gas}} \right] \\ \Delta kWh &= [\text{Gas Dryer Electric Consumption Replaced}] - [\text{Electric Dryer Consumption Added}] \\ &= \left[\left(\frac{\text{Load}}{\text{CEF}_{\text{baseGas}}} * \text{IQAdj} \right) * \text{Ncycles} * \% \text{Electric}_{\text{Gas}} \right] - \left[\frac{\text{Load}}{\text{CEff}_{\text{Elec}}} * \text{Ncycles} * \% \text{Electric}_{\text{Electric}} \right] \end{aligned}$$

¹⁷⁸ ENERGY STAR qualified dryers have a maximum test cycle time of 80 minutes. Assume one hour per dryer cycle.

¹⁷⁹ Based on coincidence factor of 3.8% for clothes washers.

MEASURE CODE: RS-APL-ESDR-V07-250101

REVIEW DEADLINE: 1/1/2026

5.1.11 ENERGY STAR Water Coolers

DESCRIPTION

Water coolers are a home appliance that offer consumers the ability to enjoy hot and/or cold water on demand. This measure is the characterization of the purchasing and use of an ENERGY STAR certified water cooler in place of a conventional water cooler.

This measure was developed to be applicable to the following program types: TOS, NC. If applied to other program types, the measure savings should be verified.

DEFINITION OF EFFICIENT EQUIPMENT

The high efficiency equipment is an ENERGY STAR certified water cooler meeting the ENERGY STAR 3.0 efficiency criteria.

DEFINITION OF BASELINE EQUIPMENT

The baseline equipment is a standard or conventional, non-ENERGY STAR certified water cooler.

DEEMED LIFETIME OF EFFICIENT EQUIPMENT

The estimated useful life for a water cooler is 10 years.¹⁸⁰

DEEMED MEASURE COST

The incremental cost for this measure is estimated at \$60.¹⁸¹

LOADSHAPE

Loadshape C53: Flat

COINCIDENCE FACTOR

The summer peak coincidence factor is assumed to be 1.0.

Algorithm

CALCULATION OF ENERGY SAVINGS

ELECTRIC ENERGY SAVINGS

$$\Delta kWh = (kWh_{base} - kWh_{ee}) * Days$$

Where:

kWh_{base} = Daily energy use (kWh/day) for baseline water cooler¹⁸²

Type of Water Cooler	kWh _{base}
Hot and Cold Water – Storage	0.875
Hot and Cold Water – On Demand	0.811
Cold Water Only	0.826

kWh_{ee} = Daily energy use (kWh/day) for ENERGY STAR water cooler¹⁸³

¹⁸⁰ Savings Calculator for ENERGY STAR Certified Water Coolers, last updated 2009.

¹⁸¹ VEIC analysis using cost data collected from retail vendor. Supporting calculations in “5.1.11_ES Water Coolers_Analysis_April 2023.xlsx”

¹⁸² CEC Product list accessed April 2023. Supporting calculations in “5.1.11_ES Water Coolers_Analysis_April 2023.xlsx”.

¹⁸³ Energy Star QPL accessed July 2023. Supporting calculations in “5.1.11_ES Water Coolers_Analysis_April 2023.xlsx”.

Type of Water Cooler	kWhe
Hot and Cold Water – Storage	0.689
Hot and Cold Water – On Demand	0.138
Cold Water Only	0.139

Days = Number of days per year that the water cooler is in use
 = 365 days¹⁸⁴

Energy Savings:

Type of Water Cooler	ΔkWh
Hot and Cold Water – Storage	68.2
Hot and Cold Water – On Demand	245.7
Cold Water Only	250.8

DEMAND SAVINGS

$$\Delta kW = \Delta kWh / \text{Hours} * CF$$

Where:

Hours = Number of hours per year water cooler is in use
 = 8760 hours¹⁸⁵

CF = Summer Peak Coincidence Factor for measure
 = 1.0

Demand Savings:

Type of Water Cooler	ΔkW
Hot and Cold Water - Storage	0.0078
Hot and Cold Water – On Demand	0.0280
Cold Water Only	0.0286

FOSSIL FUEL SAVINGS

N/A

WATER AND OTHER NON-ENERGY IMPACT DESCRIPTIONS AND CALCULATION

N/A

DEEMED O&M COST ADJUSTMENT CALCULATION

N/A

MEASURE CODE: RS-APL-WTCL-V02-240101

REVIEW DEADLINE: 1/1/2029

¹⁸⁴ Assumed 365 days per year and 24 hours per day as utilized in daily energy consumption from ENERGY STAR Program Requirements Product Specification 3.0 for Water Coolers Test Method.

¹⁸⁵ Assumed 365 days per year and 24 hours per day as utilized in daily energy consumption from ENERGY STAR Program Requirements Product Specification 3.0 for Water Coolers Test Method.

5.1.12 Ozone Laundry

DESCRIPTION

A new ozone laundry system is added-on to new or existing residential clothes washing machine(s) or washing machines located in multifamily building common areas. The system generates ozone (O₃), a naturally occurring molecule, which helps clean fabrics by chemically reacting with soils in cold water. Adding an ozone laundry system(s) eliminate the use of chemicals, detergents, and hot water by residential washing machine(s).

Energy savings will be achieved at the domestic hot water heater as it will no longer supply hot water to the washing machine. Cold water usage by the clothes washer will increase, but overall water usage will stay constant.

This measure was developed to be applicable to the following program types: TOS, RNC, RF. If applied to other program types, the measure savings should be verified.

DEFINITION OF EFFICIENT EQUIPMENT

A new, single-unit ozone laundry system(s) rated for residential clothes washing machines is added-on to new or existing residential clothes washing machines. The ozone laundry system must be connected to both the hot and cold water inlets of the clothes washing machine so that hot water from the domestic hot water heater is no longer provided to the clothes washer.

The ozone laundry system(s) must transfer ozone into the water through:

- Venturi injection
- Bubble diffusion
- Additional applications may be considered upon program review and approval on a case by case basis

DEFINITION OF BASELINE EQUIPMENT

The base case equipment is a conventional residential washing machine with no ozone generator installed. The washing machine is provided hot water from a domestic hot water heater.

DEEMED LIFETIME OF EFFICIENT EQUIPMENT

The measure equipment effective useful life (EUL) is estimated at 8 years based on the typical lifetime of products currently available in the market.¹⁸⁶

DEEMED MEASURE COST

The deemed measure cost is \$300 for a new single-unit ozone laundry system.¹⁸⁷

LOADSHAPE

Loadshape R01 – Residential Clothes Washer

COINCIDENCE FACTOR

The coincidence factor for this measure is 3.8%.¹⁸⁸

¹⁸⁶ Average based on conversations with manufacturers and distributors of the four residential ozone laundry systems tested in the 2018 GTI Residential Ozone Laundry Field Demonstration (O3 Pure, Pure Wash, Eco Washer, Scent Crusher).

¹⁸⁷ 2018 GTI Residential Ozone Laundry Field Demonstration (May 2018).

¹⁸⁸ Calculated from Itron eShapes, 8760 hourly data by end use for Missouri, as provided by Ameren.

Algorithm

CALCULATION OF ENERGY SAVINGS

ELECTRIC ENERGY SAVINGS

$$\Delta kWh = kWh_{HotWash} * (\%HotWash_{base} - \%HotWash_{Ozone})$$

Where:

$$kWh_{HotWash} = (\%ElectricDHW * Capacity * IWF * \%HotWater * (T_{OUT} - T_{IN}) * 8.33 * 1.0 * N_{cycles}) / (RE_{electric} * 3.412)$$

- $\%ElectricDHW$ = Proportion of water heating supplied by electric heating
= 100 % for Electric
= 0 % for Fossil Fuel

Utility	Location				
	Single Family	Single Family Low Income	Multi Family	Multi Family Low Income	Unknown
Ameren ¹⁸⁹	24%	25%	40%	43%	28%
ComEd ¹⁹⁰	8%		11%		9%
People's Gas ¹⁹¹	2.0%	2.0%	1.7%	2.1%	2.0%
Northshore Gas ¹⁹²	1.3%	1.8%	10.0%	2.4%	2.3%
Nicor Gas ¹⁹³	1.3%	1.8%	10.0%	2.4%	2.3%
All DUs¹⁹⁴					25%

Note: If a measure is supported by a gas and electric utility through a joint program, and it is unknown whether the participant has a gas supply, the electric utility values in the table above should be used. If it is known that the participant has a gas supply, the values from the gas utility above should be applied.

- Capacity = Clothes washer capacity (cubic feet).
= Actual. If unknown, assume 5.0 cubic feet.¹⁹⁵
- IWF = Integrated water factor (gallons/cycle/ft³).
= Actual. If unknown, use the following values

Efficiency Level	IWF (gallons/cycle/ft ³)	
	Top loading > 2.5 Cu ft	Front Loading > 2.5 Cu ft

¹⁸⁹ Provided by AEG from the 2020 Market Potential Study completed for AIC, as well as AIC Income Qualified Initiative: 2021 Participant Survey Results Memo (February 1, 2022) p. 17.

¹⁹⁰ Commonwealth Edison Residential Baseline Study (2020). p.4.4 & 4.19; Section 4-7 Water Heating. Prepared by Itron.

¹⁹¹ Implementation Contractors data from Peoples Gas and North Shore Gas for PY2022-2023.

¹⁹² Ibid.

¹⁹³ Comparable service area & customers to NSG, therefore using their survey data.

¹⁹⁴ For the weighted average calculations, please see the Analysis file. PGL, NSG, Nicor & gas customers were assumed to follow the provided split. ComEd total customers, minus overlap with PGL,NSG & Nicor, therefore electric only homes. Ameren is total customers minus Nicor.

¹⁹⁵ Average data from GTI Residential Ozone Laundry Field Demonstration (May 2018). As an add on to existing equipment it is assumed this is a larger capacity than the assumption for new Clothes Washers as old machines tended to have larger capacities. See 'Residential Ozone Summary Calcs_2019.xlsx' and 'Multifamily Ozone Summary Calcs_2019.xlsx' for more information. If utilities have specific evaluation results providing a more appropriate assumption for homes in a particular market or geographical area then that should be used.

Federal Standard (up to January 1, 2018)	8.4	4.7
Federal Standard (after January 1, 2018) – Use if unit level is unknown.	6.5	4.7
ENERGY STAR (as of February 2018)	4.3	3.2
CEE Tier 2	3.2	3.2

%HotWater = Percentage of water usage that is supplied by the domestic hot water heater when the hot or warm wash cycles are selected.¹⁹⁶

Single-Family Home	Multifamily
0.1759	0.2960

T_{OUT} = Tank temperature
= 125°F

T_{IN} = Incoming water temperature from well or municipal system
= 50.7°F¹⁹⁷

8.33 = Specific weight of water (lbs/gallon)

1.0 = Heat capacity of water (Btu/lb °F)

Ncycles = Number of Cycles per year

Single-Family Home	Multifamily
276 ¹⁹⁸	1,243 ¹⁹⁹

RE_{electric} = Recovery efficiency of electric water heater
= 0.98²⁰⁰ for Electric Resistance
= 3.51²⁰¹ for Electric HPWH

3412 = Btus to kWh conversion (Btu/kWh)

%HotWash_{base} = Average percentage of loads that use hot or warm water with baseline equipment.²⁰²

¹⁹⁶ Averaged data from GTI Residential Ozone Laundry Field Demonstration (May 2018). Hot and warm wash cycles were combined because data from the EIA Residential Energy Consumption Survey (RECS) 2015 East North Central Region show that, of the total hot and warm washes that occur, over 96% are warm washes. See 'Residential Ozone Summary Calcs_2019.xlsx' and 'Multifamily Ozone Summary Calcs_2019.xlsx' for more information.

¹⁹⁷ Table 4 in Chen, et. al., "Calculating Average Hot Water Mixes of Residential Plumbing Fixtures", June 2020, reports a value of 50.7°F for inlet water temperature for U.S. Census Division 3.

¹⁹⁸ Loads per week was estimated by taking the weighted average of the number of loads per week (midpoint used where loads per week is a range and the weights are the share of respondents falling into each number of loads per week response bin). This estimate was scaled to an IL-specific value by applying a ratio developed using the 2009 state specific values for the states in the East North Central portion of the Midwest Region.

If utilities have specific evaluation results providing a more appropriate assumption for single-family or Multifamily homes, in a particular market, or geographical area then that should be used.

¹⁹⁹ DOE Technical Support Document Chapter 6, 2010 <https://www.regulations.gov/contentStreamer?documentId=EERE-2006-STD-0127-0118&attachmentNumber=8&disposition=attachment&contentType=pdf>

²⁰⁰ Review of AHRI database shows that electric water heaters have a recovery efficiency of 98%.

²⁰¹ Review of AHRI database shows that Electric Heat Pump Water Heaters support this recovery efficiency. For the raw data, and calculations, please see AHRI_RES Water Heaters 2022.xlsx.

²⁰² GTI Residential Ozone Laundry Field Demonstration (May 2018). See 'Residential Ozone Summary Calcs_2019.xlsx' and 'Multifamily Ozone Summary Calcs_2019.xlsx' for more information.

Single-Family Home	Multifamily
0.7743	0.7438

$\%HotWash_{Ozone}$ = Percentage of loads that use hot or warm water with efficient equipment.
 = 0.0

For example, a residential ozone laundry system is installed in a single-family home with an electric domestic hot water heater. The capacity and IWF of the baseline equipment is unknown.

$$\Delta kWh = (1 * 5.0 * 6.5 * 0.1759 * (125 - 50.7) * 8.33 * 1.0 * 276) / (0.98 * 3,412) * (0.7743 - 0)$$

$$= 226 \text{ kWh}$$

SUMMER COINCIDENT PEAK DEMAND SAVINGS

$$\Delta kW = \Delta kWh / \text{Hours} * CF$$

Where:

ΔkWh = Energy Savings as calculated above

Hours = Assumed Run hours of Clothes Washer²⁰³

Single-Family Home	Multifamily
276	1,243

CF = Summer Peak Coincidence Factor for measure.
 = 0.038²⁰⁴

For example, a residential ozone laundry system is installed in a single-family home with an electric domestic hot water heater. The capacity and IWF of the baseline equipment is unknown.

$$\Delta kW = 226 / 276 * 0.038$$

$$= 0.0311 \text{ kW}$$

FOSSIL FUEL SAVINGS

$$\Delta Therm = ThermHotWash * (\%HotWash_{base} - \%HotWash_{Ozone})$$

Where:

$$ThermHotWash = (\%FossilDHW * Capacity * IWF * \%HotWater * (T_{OUT} - T_{IN}) * 8.33 * 1.0 * Ncycles) / (RE_{gas} * 100,000)$$

$\%FossilDHW$ = Percentage of DHW savings assumed to be fossil fuel
 = 100 % for Fossil Fuel
 = 0 % for Electric
 = If unknown²⁰⁵, use the following table:

²⁰³ Based on a weighted average of 276 clothes washer cycles per year assuming an average load runs for one hour.

²⁰⁴ Calculated from Itron eShapes, 8760 hourly data by end use for Missouri, as provided by Ameren.

²⁰⁵ Based on the average % electricity used for water heating in Unknown residential structure types across all utilities covered by the IL program. Residence types include: SF, SF LI, MF & MF LI. Utilities included: Ameren, ComEd, People’s Gas, Northshore Gas & Nicor. Please see subsequent table and citations for specific sources.

Utility	Location				
	Single Family	Single Family Low Income	Multi Family	Multi Family Low Income	Unknown
Ameren ²⁰⁶	76%	75%	60%	57%	72%
ComEd ²⁰⁷	92%		89%		91%
People’s Gas ²⁰⁸	97.9%	98.0%	98.3%	97.6%	97.8%
Northshore Gas ²⁰⁹	98.5%	98.2%	90.0%	97.6%	97.6%
Nicor Gas ²¹⁰	98.5%	98.2%	90.0%	97.6%	97.6%
All DUs²¹¹					75%

Note: If a measure is supported by a gas and electric utility through a joint program, and it is unknown whether the participant has a gas supply, the electric utility values in the table above should be used. If it is known that the participant has a gas supply, the values from the gas utility above should be applied.

RE_gas = Recovery efficiency of gas water heater

Single-Family Homes	Multifamily
79% ²¹²	67% ²¹³

100,000 = Btus to Therms conversion (Btu/Therm).

For example, a residential ozone laundry system is installed in a single-family home with a gas domestic hot water heater. The capacity and IWF of the baseline equipment is unknown.

$$\Delta\text{Therms} = (1 * 5.0 * 6.5 * 0.1759 * (125 - 50.7) * 8.33 * 1.0 * 276) / (0.79 * 100,000) * (0.7743 - 0)$$

$$= 9.6 \text{ Therms}$$

WATER IMPACT DESCRIPTIONS AND CALCULATION

N/A

²⁰⁶ Provided by AEG from the 2020 Market Potential Study completed for AIC, as well as AIC Income Qualified Initiative: 2021 Participant Survey Results Memo (February 1, 2022) p. 17.

²⁰⁷ Commonwealth Edison Residential Baseline Study (2020). p.4.4 & 4.19; Section 4-7 Water Heating. Prepared by Itron.

²⁰⁸ Residential Appliance Saturation Survey of natural gas for space heating and water heating (2021). Note, Multifamily customers have a residential billing rate code and responded on the survey that they live in an apartment or condominium in a building that has either 2-4 or 5+ units.

²⁰⁹ Ibid.

²¹⁰ Comparable service area & customers to NSG, therefore using their survey data.

²¹¹ For the weighted average calculations, please see the Analysis file. PGL, NSG, Nicor & gas customers were assumed to follow the provided split. ComEd total customers, minus overlap with PGL,NSG & Nicor, therefore gas only homes. Ameren is total customers minus Nicor.

²¹² DOE Final Rule discusses Recovery Efficiency with an average around 0.76 for Gas Fired Storage Water heaters and 0.78 for standard efficiency gas fired tankless water heaters up to 0.95 for the highest efficiency gas fired condensing tankless water heaters. These numbers represent the range of new units however, not the range of existing units in stock. Review of AHRI Directory suggests range of recovery efficiency ratings for new Gas DHW units of 70-87%. Average of existing units is estimated at 79%.

²¹³ Water heating in Multifamily buildings is often provided by a larger central boiler. This suggests that the average recovery efficiency is somewhere between a typical central boiler efficiency of 0.59 and the 0.75 for single family homes. An average efficiency of 0.67 is used for this analysis as a default for Multifamily buildings.

DEEMED O&M COST ADJUSTMENT CALCULATION

LAUNDRY DETERGENT SAVINGS

Annual savings from not purchasing laundry detergent that are realized by efficient equipment end-user(s) (\$/year).

$$\text{Detergent savings per year} = \text{Detergent_cost} * \text{Ncycles}$$

Where:

$$\begin{aligned} \text{Detergent_cost} &= \text{Average laundry detergent cost per load (\$/load).} \\ &= 0.16^{214} \end{aligned}$$

For example, a residential ozone laundry system is installed in a single-family home.

$$\begin{aligned} \text{Detergent savings per year} &= 0.16 * 276 \\ &= \$44.16 \end{aligned}$$

MEASURE CODE: RS-APL-OZNE-V07-250101

REVIEW DEADLINE: 1/1/2026

²¹⁴ Based on cost analysis of products available on www.Jet.com and www.Amazon.com.

5.1.13 Income Qualified: ENERGY STAR and CEE Tier 2 Room Air Conditioner - Retired 12/31/2014

Measure combined with 5.1.7 ENERGY STAR and CEE Tier 2 Room Air Conditioner.

5.1.14 Residential Induction Cooking Appliances

DESCRIPTION

A fully electric range with an electric oven and an induction cooktop or a freestanding induction cooktop installed in place of an electric range with an electric resistance cooktop, natural gas range, or a freestanding electric resistance cooktop.

This measure was developed to be applicable to the following program types: TOS, NC. If applied to other program types, the measure savings should be verified.

DEFINITION OF EFFICIENT EQUIPMENT

The efficient equipment is defined as a freestanding cooktop that heats cooking vessels using electrical induction or a range with an electric resistance oven and an electric induction cooktop for residential applications.

DEFINITION OF BASELINE EQUIPMENT

The baseline reflects the cooking efficiencies of electric resistance cooktops and gas cooktops. Cooking efficiency is defined as the ratio of energy absorbed by the object being heated (food, water, etc.) and the energy consumed by the appliance.

Cooktop Type	Cooking Efficiency ²¹⁵
Electric Resistance	77%
Natural Gas	32%

DEEMED LIFETIME OF EFFICIENT EQUIPMENT

The assumed lifetime of the measure is 16 years.²¹⁶

DEEMED MEASURE COST

The incremental cost for ovens with induction cooktops compared to a baseline oven with resistance or gas cooktop is assumed to be \$949 and the incremental cost for induction cooktop only over resistance or gas cooktop is \$687²¹⁷. In addition, assume \$100 additional labor from an electric baseline to install additional power/socket requirements, and an additional \$200 labor from a gas baseline to also cap the gas line.²¹⁸

LOADSHAPE

Loadshape R20 – Residential Induction Cooktop

COINCIDENCE FACTOR

The coincidence factor is assumed to be 29%.²¹⁹

²¹⁵ The cooking efficiencies of electric resistance, gas, and induction cooktops are tested and calculated in the *Residential Cooktop Performance and Energy Comparison Study* conducted by Frontier Energy, July 2019.

²¹⁶ The EUL was developed for the U.S. Department of Energy (DOE) Energy Conservation Program, Energy Conservation Standards for Residential Conventional Cooking Products as part of the 2016 supplemental notice of proposed rulemaking (SNOPR).

²¹⁷ Southern California Edison (SCE). 2019. "SWAP015-01 Costs.xlsx". This reference only looked at electric ovens/cooktops, but VEIC compared baseline electric and gas units and found very little difference in cost.

²¹⁸ Additional labor costs are an estimate.

²¹⁹ Calculated from ResStock, 15 minute interval data by end use for Illinois, as provided by NREL.

Algorithm

CALCULATION OF ENERGY SAVINGS

ELECTRIC ENERGY AND FOSSIL FUEL SAVINGS

Non Fuel Switch Measures (baseline is electric cooktop or range)

$$\Delta kWh = \text{CooktopAEC}_{\text{base}} - \text{CooktopIAEC}_{\text{ee}}$$

Fuel switch measure (baseline is natural gas cooktop or range):

Fuel switch / electrification measures must produce positive total energy savings (i.e., reduction in Btus at the premises) in order to qualify. This is determined as follows:

$$\Delta \text{SiteEnergySavings (MMBtu)} = [\Delta \text{CookingSavings}] + [\text{HVACImpacts}]$$

$$\Delta \text{CookingSavings} = \text{FuelSwitchSavings} + \text{NonFuelSwitchSavings}$$

$$\text{FuelSwitchSavings} = [\text{GasConsumptionReplaced}] - [\text{ElectricConsumptionAdded}]$$

$$\text{NonFuelSwitchSavings} = [\text{ElectricConsumptionReplaced}]$$

$$\text{GasConsumptionReplaced} = \text{AEC}_{\text{baseGas}} / 10$$

$$\text{ElectricConsumptionAdded} = \text{IAEC}_{\text{ee}} * 3,412 / 1,000,000$$

$$\text{ElectricConsumptionReplaced} = \text{AEC}_{\text{baseElectric}} * 3,412 / 1,000,000$$

$$\text{HVACImpacts [counted as non-fuel switch savings]} = [\text{CoolingImpact}] - [\text{ElecHeatImpact}] - [\text{FuelHeatImpact}]$$

$$\text{CoolingImpact} = \Delta \text{CookingSavings} * \% \text{Cool} * \text{HCF}_{\text{COOL}} * \text{VentFactor} / \text{COP}_{\text{COOL}}$$

$$\text{ElecHeatImpact} = \Delta \text{CookingSavings} * \% \text{ElectricHeat} * \text{HCF}_{\text{HEAT}} * \text{VentFactor} / \text{COP}_{\text{HEAT}}$$

$$\text{FuelHeatImpact} = \Delta \text{CookingSavings} * \% \text{FossilHeat} * \text{HCF}_{\text{HEAT}} * \text{VentFactor} / \eta_{\text{Heat}}$$

If $\Delta \text{SiteEnergySavings}$ calculated above is positive, the measure is eligible.

The appropriate savings claim is dependent on which utilities are supporting the measure as provided in a table below:

Measure supported by:	Electric Utility claims (kWh):	Gas Utility claims (therms):
Electric utility only	$\Delta \text{SiteEnergySavings} * 1,000,000 / 3,412$	N/A
Electric and gas utility (Note utilities may make alternative agreements to how savings are allocated as long as total MMBtu savings remains the same).	$\% \text{IncentiveElectric} * \Delta \text{SiteEnergySavings} * 1,000,000 / 3,412$	$\% \text{IncentiveGas} * \Delta \text{SiteEnergySavings} * 10$
Gas utility only	N/A	$\Delta \text{SiteEnergySavings} * 10$

Where:

CooktopIAEC _{ee}	= Integrated Annual Energy Consumption of an induction cooktop ²²⁰ in kWh/yr = Actual if IAEC is unknown, if unknown assume 111 kWh/yr ²²¹ .
CooktopAEC _{baseElec}	= Annual Energy Consumption of a baseline electric cooktop in kWh/yr = CooktopIAEC _{ee} * (Eff _{ee} / Eff _{base}) = If values unknown, assume 111 * 0.85/0.77 = 122.5 kWh/yr
Eff _{ee}	= cooking efficiency of the induction cooktop = Actual. If unknown, assume 85% ²²² .
Eff _{base}	= cooking efficiency of baseline cooktop = Actual. If unknown, assume 77% ²²³ for electric resistance cooktop.
IAEC _{ee}	= Integrated Annual Energy Consumption of induction cooking appliance in kWh/yr = CooktopIAEC _{ee} + OvenIAEC _{ee}
OvenIAEC _{ee}	= Annual Energy Consumption of electric oven in kWh/yr = 0 for standalone cooktop appliances For ranges, if actual OvenIAEC _{ee} is unknown, assume a value of 171.6 kWh/yr ²²⁴
AEC _{baseElec}	= Annual Electric Energy Consumption of baseline gas cooking appliance in kWh/yr, for standby and ignition energy = 0 for standalone cooktop appliances For ranges, if AEC _{baseElec} is unknown, assume a value of 54.3 kWh/yr ²²⁵
AEC _{baseGas}	= Annual Energy Consumption of a baseline gas cooking appliance in therms/yr = CooktopAEC _{base} + OvenAEC _{base} For ranges, if unknown, assume 21.3 therms. ²²⁶
CooktopAEC _{baseGas}	= Annual Energy Consumption of baseline gas cooktop in therms/yr If unknown, assume 12.7 therms ²²⁷
OvenAEC _{baseGas}	= Annual Energy Consumption of baseline gas oven in therms/yr = 0 for standalone cooktop appliances For ranges, if actual OvenAEC _{baseGas} is unknown, assume a value of 8.6 therms ²²⁸ .

²²⁰ The energy measurements are performed at an ISO/IEC 17025 accredited lab as specified in the application process for the ENERGY STAR Emerging Technology Award. Approved products on the [ENERGY STAR Qualified Products List](#) have IAEC values listed.

²²¹ Average Integrated Annual Energy Consumption (IAEC) of an induction cooktop on the ENERGY STAR Emerging Technology Award Qualified Products List, accessed June 2022, is 111 kWh.

²²² The cooking efficiencies of electric resistance, gas, and induction cooktops are tested and calculated in the *Residential Cooktop Performance and Energy Comparison Study* conducted by Frontier Energy.

²²³ Ibid

²²⁴ Annual energy consumption for ovens calculated in SWAP013-01 *Residential Cooking Appliances – Fuel Substitution* workpaper.

²²⁵ Ibid

²²⁶ DOE EIA Energy Outlook estimates 21.3 therms per household for fuel cooking.

²²⁷ DOE EIA estimates 21.3 therms per household for fuel cooking, minus estimated 8.6 therms for oven usage.

²²⁸ IAEC for ovens calculated in SWAP013-01 *Residential Cooking Appliances – Fuel Substitution* workpaper

%ElectricHeat = Percentage of homes that have electric heating
 = 100% if electrically heated home, 0% if gas, or
 = If unknown²²⁹, use the following table:

Utility	Location				
	Single Family	Single Family Low Income	Multi Family	Multi Family Low Income	Unknown
Ameren	18%	26%	38%	39%	29%
ComEd	14%	22%	43%	48%	21%
PGL	1.0%	1.5%	4.0%	2.8%	2.2%
NSG	1.3%	0.8%	32.5%	1.2%	3.3%
Nicor	1.3%	0.8%	32.5%	1.2%	3.3%
All DUs²³⁰					26%

Note: If a measure is supported by a gas and electric utility through a joint program, and it is unknown whether the participant has a gas supply, the electric utility values in the table above should be used. If it is known that the participant has a gas supply, the values from the gas utility above should be applied.

%FossilHeat = Percentage of homes that have fossil fuel heating
 = 100% if fossil heated home, 0% if electric, or
 = If unknown²³¹, use the following table:

Utility	Location				
	Single Family	Single Family Low Income	Multi Family	Multi Family Low Income	Unknown
Ameren	82%	74%	62%	61%	71%
ComEd	86%	78%	57%	52%	79%
PGL	98.9%	98.5%	96.0%	96.9%	97.7%
NSG	98.3%	99.2%	67.5%	98.8%	96.6%
Nicor	98.3%	99.2%	67.5%	98.8%	96.6%
All DUs²³²					74%

Note: If a measure is supported by a gas and electric utility through a joint program, and it is unknown whether the participant has a gas supply, the electric utility values in the table above should be used. If it is known that the participant has a gas supply, the values from the gas utility above should be applied.

²²⁹ Based on the average % Natural Gas used for space heating in Unknown residential structure types across all utilities covered by the IL program. Residence types include: SF, SF LI, MF & MF LI. Utilities included: Ameren, ComEd, People’s Gas, Northshore Gas & Nicor. Data provided from 2016 Ameren Illinois Demand Side Management (DSM) Market Potential Study by Applied Energy Group, ComEd’s 2019 Baseline Survey on residential space heating share, and PY2022-2023 Implementation Contractors Data for People’s Gas, Northshore Gas & Nicor .

²³⁰ For the weighted average calculations, please see the Analysis file. PGL, NSG, Nicor & gas customers were assumed to follow the provided split. ComEd total customers, minus overlap with PGL,NSG & Nicor, therefore electric only homes. Ameren is total customers minus Nicor.

²³¹ Based on the average % Natural Gas used for space heating in Unknown residential structure types across all utilities covered by the IL program. Residence types include: SF, SF LI, MF & MF LI. Utilities included: Ameren, ComEd, People’s Gas, Northshore Gas & Nicor. Data provided from 2016 Ameren Illinois Demand Side Management (DSM) Market Potential Study by Applied Energy Group, ComEd’s 2019 Baseline Survey on residential space heating share, and PY2022-2023 Implementation Contractors Data for People’s Gas, Northshore Gas & Nicor .

²³² For the weighted average calculations, please see the Analysis file. PGL, NSG, Nicor & gas customers were assumed to follow the provided split. ComEd total customers, minus overlap with PGL,NSG & Nicor, therefore gas only homes. Ameren is total customers minus Nicor.

- %Cool = Percent of homes that have cooling
= 100% if home has central cooling, 0% if not, or if unknown 66%²³³
- HCF_{COOL} = 21%, Portion of reduced waste heat that is coincident with home cooling load²³⁴
- VentFactor = 50%²³⁵
- COP_{COOL} = COP of central air conditioning
= Assume 3.3 if unknown²³⁶
- HCF_{HEAT} = 34.8%, portion of reduced waste heat that is coincident with home heating load²³⁷
- COP_{HEAT} = COP of electric heating system
= actual. If not available use:²³⁸

System Type	HSPF2 Estimate	COP _{HEAT} (COP Estimate) = (HSPF/3.412)*0.85
Heat Pump	7.5	1.87
Resistance	N/A	1.00
Unknown electric ²³⁹	N/A	1.30

- ηHeat = Efficiency of heating system
= 0.70 ²⁴⁰

²³³ Percentage of homes in Illinois that have central cooling from “Table HC7.9 Air Conditioning in Homes in Midwest Region, Divisions, and States, 2009” from Energy Information Administration, 2009 Residential Energy Consumption Survey

²³⁴ Additional cooling savings from HVAC interactive effects of 21% of appliance savings, estimated using average result from BEOPT simulation modeling comparing two different home configurations and two locations. Ratio compares the changes in home HVAC loads to changes in appliance energy consumption.

²³⁵ This factor approximates the effectiveness of kitchen ventilation systems in exhausting waste heat from the home. Reference reviewed include 1. Kile et al. Environmental Health 2014, 13:71 (<http://www.ehjournal.net/content/13/1/71>) which showed 221 of 445 surveyed used exhaust during cooktop cooking; also 2. Cooking Appliance Use in CA Homes. Victoria L. Klug, Agnes B. Lobscheid, Brett C. Singer Environmental Energy Technologies Division Lawrence Berkeley National Laboratory, Berkeley, California, USA August 2011 which showed 44% of respondents use the range hood during dinner cooking and an additional 37% of respondents open windows during dinner cooking.

²³⁶ To reduce complexity of the measure and since this relates to a small waste heat impact, instead of assuming actual existing unit HVAC efficiency and a mid-life adjustment to account for future replacement efficiency, the code minimum baseline should be applied. Starting from federal baseline of SEER 13 central AC unit, converted to 11.1 EER using algorithm $(-0.02 * SEER2) + (1.12 * SEER)$ (from Wassmer, M. (2003). A Component-Based Model for Residential Air Conditioner and Heat Pump Energy Calculations. Masters Thesis, University of Colorado at Boulder), converted to COP = EER/3.412 = 3.3COP.

²³⁷ Heating penalty of 34.8% of appliance savings, estimated using average result from BEOPT simulation modeling comparing two different home configurations and two locations. Ratio compares the changes in home HVAC loads to changes in appliance energy consumption.

²³⁸ To reduce complexity of the measure and since this relates to a small waste heat impact, instead of assuming actual existing unit HVAC efficiency and a mid-life adjustment to account for future replacement efficiency, the code minimum baseline should be applied. Note efficiency includes duct losses. Defaults provided assume 15% duct loss for heat pumps.

²³⁹ Calculation assumes 35% Heat Pump and 65% Resistance, which is based upon data from Energy Information Administration, 2009 Residential Energy Consumption Survey, see “HC6.9 Space Heating in Midwest Region.xls”, using average for East North Central Region. Program or evaluation data should be used to improve this assumption if available.

²⁴⁰ This has been estimated assuming that natural gas central furnace heating is typical for Illinois residences (66% of Illinois homes have a Natural Gas Furnace (based on Energy Information Administration, 2009 Residential Energy Consumption Survey) In 2000, 24% of furnaces purchased in Illinois were condensing (based on data from GAMA, provided to Department of Energy during the federal standard setting process for residential heating equipment - see Furnace Penetration.xls). Furnaces tend to

Non-fuel switch example, a residential induction cooktop will replace an electric resistance cooktop. The annual energy consumption of the induction cooktop has not been measured. The electric savings are calculated below:

$$\Delta kWh = \text{CooktopAEC}_{\text{base}} - \text{CooktopIAEC}_{\text{ee}}$$

$$\text{CooktopIAEC}_{\text{ee}} = 111 \text{ kWh/yr}$$

$$\text{CooktopAEC}_{\text{base}} = 111 * (0.85 / 0.77)$$

$$= 122.5 \text{ kWh/yr}$$

$$\Delta kWh = 122.5 - 111$$

$$= 11.5 \text{ kWh/yr}$$

last up to 20 years and so units purchased 10 years ago provide a reasonable proxy for the current mix of furnaces in the State. Assuming typical efficiencies for condensing and non-condensing furnaces and duct losses, the average heating system efficiency is estimated as follows:

$$(0.24 * 0.92) + (0.76 * 0.8) * (1 - 0.15) = 0.70$$

Fuel switch example: a residential induction cooktop will replace a natural gas cooktop. The annual energy consumption of the induction cooktop has not been measured and the homes heating fuel and presence of central cooling is unknown. The savings for a measure supported by an electric utility are calculated below:

$$\begin{aligned} \Delta\text{SiteEnergySavings (MMBtu)} &= [\Delta\text{CookingSavings}] + [\text{HVACImpacts}] \\ \Delta\text{CookingSavings} &= [\text{GasConsumptionReplaced}] - [\text{ElectricConsumptionAdded}] \\ &= [\text{CooktopAEC}_{\text{base}}/10] - [\text{CooktopIAEC}_{\text{ee}} * 3,412/1,000,000] \\ &= [12.7/10] - [111 * 3412/1000000] \\ &= 1.27 - 0.379 \\ &= 0.891 \text{ MMBtu} \\ \text{CoolingImpact} &= \Delta\text{CookingSavings} * \%Cool * \text{HCF}_{\text{COOL}} * \text{VentFactor} / \text{COP}_{\text{COOL}} \\ &= 0.891 * 0.66 * 0.21 * 0.5 / 3.3 \\ &= 0.019 \text{ MMBtu} \\ \text{ElecHeatImpact} &= \Delta\text{CookingSavings} * \%ElecHeat * \text{HCF}_{\text{HEAT}} * \text{VentFactor} / \text{COP}_{\text{HEAT}} \\ &= 0.891 * 0.26 * 0.348 * 0.5 / 1.3 \\ &= 0.031 \text{ MMBtu} \\ \text{FuelHeatImpact} &= \Delta\text{CookingSavings} * \%GasHeat * \text{HCF}_{\text{HEAT}} * \text{VentFactor} / \eta_{\text{Heat}} \\ &= 0.891 * 0.74 * 0.348 * 0.5 / 0.7 \\ &= 0.164 \text{ MMBtu} \\ \text{HVAC Impacts} &= [\text{CoolingImpact}] - [\text{ElecHeatImpact}] - [\text{FuelHeatImpact}] \\ &= 0.019 - 0.031 - 0.164 \\ &= -0.176 \text{ MMBtu} \\ \Delta\text{SiteEnergySavings (MMBtu)} &= 0.891 + (- 0.176) \\ &= 0.715 \text{ MMBtu} \end{aligned}$$

SUMMER COINCIDENT PEAK DEMAND SAVINGS

For Non-Fuel Switching measures:

$$\Delta\text{kW} = (\text{CooktopAEC}_{\text{base}} - \text{CooktopIAEC}_{\text{ee}}) / \text{Hours} * \text{WHFd} * \text{CF}$$

For Fuel Switching measures:

$$\Delta\text{kW} = ((\text{AEC}_{\text{baseElectric}} - \text{IAEC}_{\text{ee}} + [\text{CoolingImpact}] - [\text{ElecHeatImpact}]) * 1,000,000/3,412) / \text{Hours} * \text{WHFd} * \text{CF}$$

Where:

$$\text{Hours} = \text{Annual operating hours}^{241}$$

²⁴¹ Assuming 1 hours per cycle and 239 cycles per year therefore 239 operating hours per year. 239 cycles per year is based on a 2016 CASE study for PG&E modeling Plug Loads.

	= 239 hours
WHFd	= Waste heat factor for demand to account for cooling savings from efficient appliance. = 1.11 ²⁴²
CF	= Summer Peak Coincidence Factor = 29% ²⁴³

All other variables as presented above

FOSSIL FUEL SAVINGS

Calculation provided together with Electric Energy Savings above.

WATER AND OTHER NON-ENERGY IMPACT DESCRIPTIONS AND CALCULATION

N/A

DEEMED O&M COST ADJUSTMENT CALCULATION

N/A

COST EFFECTIVENESS SCREENING AND LOAD REDUCTION FORECASTING WHEN FUEL SWITCHING

This measure can involve fuel switching from fossil fuel to electric.

For the purposes of forecasting load reductions due to fuel switch projects per Section 16-111.5B, changes in site energy use at the customer’s meter (using ΔkWh algorithm below) adjusted for utility line losses (at-the-busbar savings), customer switching estimates, NTG, and any other adjustment factors deemed appropriate, should be used.

The inputs to cost effectiveness screening should reflect the actual impacts on the electric and fuel consumption at the customer meter and, for fuel switching measures, this will not match the output of the calculation/allocation methodology presented in the “Electric Energy Savings” and “Fossil Fuel Savings” sections above. Therefore in addition to the calculation of savings claimed, the following values should be used to assess the cost effectiveness of the measure.

$$\Delta\text{Therms} = ([\text{Gas Cooking Consumption Replaced}] - [\text{FuelHeatImpact}]) * 10$$

$$= (\text{AEC}_{\text{baseGas}} - \text{FuelHeatImpact}) * 10$$

$$\Delta\text{kWh} = ([\text{Electric Cooking Replaced}] - [\text{Electric Cooking Consumption Added}] + [\text{CoolingImpact}] - [\text{ElecHeatImpact}]) * 1,000,000/3,412$$

$$= (\text{AEC}_{\text{baseElectric}} - \text{IAEC}_{\text{ee}} + [\text{CoolingImpact}] - [\text{ElecHeatImpact}]) * 1,000,000/3,412$$

MEASURE CODE: RS-MSC-INDC-V03-250101

REVIEW DEADLINE: 1/1/2026

²⁴² The value is estimated at 1.11 (calculated as 1 + (0.66 * 0.466 / 2.8)). See footnote relating to WHFe for details. Note the 46.6% factor represents the average Residential cooling coincidence factor calculated by dividing average load during the peak hours divided by the maximum cooling load.

²⁴³ Calculated from ResStock, 15 minute interval data by end use for Illinois, as provided by NREL.

5.1.15 Residential Bolt-On Smart Dryer Sensor

DESCRIPTION

This measure relates to the installation of a bolt-on smart wifi enabled dryer sensor with cloud data storage access on a residential gas-fired or electric dryer. A smart dryer sensor is an add-on device, which turns any residential dryer into a smart dryer. The device consists of

- 1) a sensor that detects temperature and humidity in the dryer
- 2) a connected hub with a built-in auto shut-off mechanism

The sensor monitors the temperature and humidity inside the clothes dryer to determine when a load is dry. When the humidity levels in the dryer fall below a pre-set cut-off at steady state, the device determines that a load is dry. The sensor then notifies the connected auto shut-off mechanism, cutting off power to the dryer and turning it off.

Residential clothes dryers have not changed significantly in their operation for many years. They typically offer either a time-dry setting (which uses a set timer) or an auto-dry setting (which uses a built-in moisture sensor to determine when the clothes are dry). Most built-in manufacturer moisture sensors do not work well, and users tend to predominantly use the time-dry setting. This measure does not apply to dryers with coin operated mechanical timers, laundromat facilities or commercial clothes dryers. This measure was developed to be applicable to the following program types: TOS, RF, NC, DI and KITS.

If applied to other program types, the measure savings should be verified.

DEFINITION OF EFFICIENT EQUIPMENT

Natural gas-fired or electric resistance dryers with a residential bolt-on smart dryer sensor installed.

DEFINITION OF BASELINE EQUIPMENT

The base case equipment is a conventional gas-fired or electric resistance residential dryer without a bolt-on smart dryer sensor installed. The dryer may have a built-in moisture sensor installed. The gas-fired dryer has a natural gas fuel-fired burner element and an electric powered drum motor.

DEEMED LIFETIME OF EFFICIENT EQUIPMENT

The expected measure life is assumed to be same as that of the clothes dryer, which is 16 years.²⁴⁴

DEEMED MEASURE COST

The deemed measure cost is \$60 for a new residential bolt-on smart dryer sensor when installed on a gas-fired dryer. This applies to a non-intrusive bolt-on sensor installed with a magnetically attachable sensor inside the drum and a wirelessly connected plug with an auto shut-off.²⁴⁵

When attached to an electric dryer the deemed measure cost is \$150²⁴⁶.

Actual costs should be used when available or if the smart sensor setup is different from the above.

LOADSHAPE

Loadshape R17 - Residential Electric Dryer

COINCIDENCE FACTOR

N/A

²⁴⁴ Based on DOE Rulemaking Technical Support Document, LCC Chapter, 2011, as recommended in Navigant 'ComEd Effective Useful Life Research Report', May 2018.

²⁴⁵ Based on Nicor Gas ETP field demonstration of Residential IoT Smart Dryer Sensors.

²⁴⁶ Based on current market cost for TickleStar DryerSaver Model #TS2201.

Algorithm

CALCULATION OF ENERGY SAVINGS

ELECTRIC ENERGY SAVINGS

For all dryers, please use the following equation for calculating energy savings, related to the motor:

$$\Delta kWh_{\text{motor}} = N_{\text{cycles}} * (\text{Motor}_{\text{runtimesavings}}) * \text{Motor}_{\text{kW}}$$

Where:

$$N_{\text{cycles}} = \text{Number of dryer cycles per year. Use actual data if available. If unknown:} \\ = 259 \text{ cycles per year.}^{247}$$

$$\text{Motor}_{\text{runtimesavings}} = \text{Runtime savings for dryer drum motor} \\ = 0.39 \text{ hrs/load}^{248}$$

$$\text{Motor}_{\text{kW}} = \text{Rated electric power draw of drum motor. Use actual nameplate data. If unknown,} \\ = 0.25 \text{ kW.}^{249}$$

For electric resistance dryers, please use the following equation for calculating energy savings, related to the heating element:

$$\Delta kWh_{\text{heating}} = N_{\text{cycles}} * \text{RunTimeSavings} * \text{Dryer Draw Rate} / 1,000$$

Where:

$$\text{RunTimeSavings} = \text{Runtime savings for dryer heating element} \\ = 0.08 \text{ hrs/load}^{250}$$

$$\text{Dryer Draw Rate} = \text{Draw of electric resistance dryer heaters.} \\ = \text{Use actual nameplate data if available. If unknown, 5,250 Watts.}^{251}$$

SUMMER COINCIDENT PEAK DEMAND SAVINGS

$$\Delta kW = \Delta kWh / \text{Hours} * CF$$

Where:

$$\Delta kWh = \text{Electric Energy Savings as calculated above} \\ \text{For gas-fired dryers} = \Delta kWh_{\text{motor}}$$

²⁴⁷ Loads per week was estimated by taking the weighted average of the number of loads per week (midpoint used where loads per week is a range and the weights are the share of respondents falling into each number of loads per week response bin). This estimate was scaled to an IL-specific value by applying a ratio developed using the 2009 state specific values for the states in the East North Central portion of the Midwest Region. Reduced by 6% to maintain prior ratio of dryer to clothes washer loads of 94%.

²⁴⁸ Average data based on Nicor Gas ETP field demonstration of Residential IoT Smart Dryer Sensors. Please see Analysis file.

²⁴⁹ Average Residential dryer drum motors, which typically range between 200 W and 300 W. Please see ENERGY STAR Scoping Reporting for Residential Clothes Dryers file, Table 2, page 3.

²⁵⁰ Average data based on Nicor Gas ETP field demonstration of Residential IoT Smart Dryer Sensors. Based on natural-gas fired dryer data, and assuming similar savings will be seen for electric dryer.

²⁵¹ Average Residential electric resistance heaters typically draw about 5,000 - 5,500 watts. Please see ENERGY STAR Scoping Reporting for Residential Clothes Dryers file, Table 2, page 3.

$$\text{For electric dryers} \quad = \Delta kWh_{\text{motor}} + \Delta kWh_{\text{heating}}$$

Hours = Annual run hours of clothes dryer.

= Use actual data, if available. If unknown, use 259 hours per year.²⁵²

CF = Summer Peak Coincidence Factor for measure

= 3.8%²⁵³

FOSSIL FUEL SAVINGS

For natural gas-fired dryers, please use the following equation for calculating energy savings:

$$\Delta \text{Therm} = N_{\text{cycles}} * \text{Therm}_{\text{convert}} * \text{RunTimeSavings} * \text{Dryer Firing Rate}$$

Where:

N_{cycles} = Number of dryer cycles per year.

= Use actual data, if available. If unknown, use 259 cycles per year.²⁵⁴

$\text{Therm}_{\text{convert}}$ = Conversion factor from Btu to Therm

= 0.00001

RunTimeSavings = Runtime savings for gas dryer burner element

= 0.08 hrs/load²⁵⁵

Dryer Firing Rate = Firing rate of the natural gas-fired dryer burner.

= Use actual nameplate data, if available. If unknown, use 22,500 Btu/hr.²⁵⁶

For example, A single-family home in Chicago is retrofitting a residential bolt-on smart dryer sensor on a 22,500 Btu/hr natural gas-fired dryer with 400 loads annually. The annual savings for the installation would be:

Electric Energy Savings

$$= 400 \times 0.39 \times 0.25$$

$$= 39 \text{ kWh}$$

Natural Gas Savings

$$= 400 \times 0.00001 \times 0.08 \times 22,500$$

$$= 7.2 \text{ therms}$$

²⁵² ENERGY STAR qualified dryers have a maximum test cycle time of 80 minutes. Assume one hour per dryer cycle from existing TRM measure 5.1.10.

²⁵³ Based on coincidence factor of 3.8% for clothes washers from existing Illinois TRM measure 5.1.10.

²⁵⁴ Loads per week was estimated by taking the weighted average of the number of loads per week (midpoint used where loads per week is a range and the weights are the share of respondents falling into each number of loads per week response bin). This estimate was scaled to an IL-specific value by applying a ratio developed using the 2009 state specific values for the states in the East North Central portion of the Midwest Region. Reduced by 6% to maintain prior ratio of dryer to clothes washer loads of 94%..

²⁵⁵ Average data based on Nicor Gas ETP field demonstration of Residential IoT Smart Dryer Sensors. See Analysis file for details.

²⁵⁶ Residential dryer burners typically range between 20,000 Btu/hr – 25,000 Btu/hr. Please see ENERGY STAR Scoping Reporting for Residential Clothes Dryers file, Table 2, page 3.

WATER AND OTHER NON-ENERGY IMPACT DESCRIPTIONS AND CALCULATION

N/A

DEEMED O&M COST ADJUSTMENT CALCULATION

N/A

MEASURE CODE: RS-APL-SCDS-V02-250101

REVIEW DEADLINE: 1/1/2030

5.1.16 Electric Lawn and Garden Equipment

DESCRIPTION

This measure identifies the claimed savings associated with residential lawn equipment electrification. This measure was developed to be applicable to the following program types: TOS.

Time of Sale (TOS):

- The use of an all-electric equipment in place of an equipment with a spark-ignition gasoline-powered engine.
- Note that the baseline in this case is an equivalent replacement system to that which exists currently in the home.

If applied to other program types, the measure savings should be verified.

DEFINITION OF EFFICIENT EQUIPMENT

The efficient condition is an all-electric lawn or garden equipment sized to be equivalent to the baseline equipment.

DEFINITION OF BASELINE EQUIPMENT

The baseline condition is new gasoline-powered lawn or garden equipment.

DEEMED LIFETIME OF EFFICIENT EQUIPMENT

The expected measure life varies based on the equipment type (displayed in the table below).

Equipment Type	Measure Life (years) ²⁵⁷
Riding Lawn Mower	9
Push Lawn Mower	9
Leaf Blower	5
Trimmer	5
Chainsaw	7

DEEMED MEASURE COST

For Time of Sale (TOS) the incremental cost should be used. Actual costs can also be used although care should be taken as costs can vary significantly. Defaults are provided below.

Equipment Type	Incremental Cost ²⁵⁸
Riding Lawn Mower	\$3,890
Push Lawn Mower	\$419
Leaf Blower	\$206
Trimmer	\$272
Chainsaw	\$384

²⁵⁷ CARB (2022). CCI Emission Factor Database, “Fuel-Specific GHG” worksheet, available at [cci_emissionfactordatabase 2022-11-30.xlsx \(live.com\)](#).

²⁵⁸ Vermont Act 56 Tier III Technical Advisory Group 2021 ANNUAL REPORT

LOADSHAPE

Loadshape R08 – Residential Cooling²⁵⁹

COINCIDENCE FACTOR

The summer Peak Coincidence Factor is assumed to be 30%.²⁶⁰

Algorithm

CALCULATION OF ENERGY SAVINGS

ELECTRIC ENERGY AND FOSSIL FUEL SAVINGS

Fuel switch measure (baseline is gas equipment):

Fuel switch / electrification measures must produce positive total energy savings (i.e., reduction in Btus at the premises) in order to qualify. This is determined as follows:

$$\begin{aligned} \Delta \text{SiteEnergySavings (MMBtu)} &= [\text{GasConsumptionReplaced}] - [\text{ElectricConsumptionAdded}] \\ &= [\text{Fuel}_{\text{baseline}} * 120,238/1,000,000] - [\text{Fuel}_{\text{baseline}} * \text{ED}_{\text{gasoline}} / (\text{ED}_{\text{electricity}} * \text{EER}_{\text{G} \rightarrow \text{E}}) * 3,412/1,000,000] \\ \text{Fuel}_{\text{baseline}} &= (\text{BSFC}_{\text{baseline}} * \text{hp}_{\text{baseline}} * \text{LF}_{\text{baseline}} * \text{Hours}) / (\text{Fuel Density}_{\text{gasoline}}) \end{aligned}$$

If SiteEnergySavings calculated above is positive, the measure is eligible.

The appropriate savings claim is dependent on which utilities are supporting the measure as provided in a table below:

Measure supported by:	Electric Utility claims (kWh):	Gas Utility claims (therms):
Electric utility only	SiteEnergySavings * 1,000,000/3,412	N/A
Electric and gas utility (Note utilities may make alternative agreements to how savings are allocated as long as total MMBtu savings remains the same).	%IncentiveElectric * SiteEnergySavings * 1,000,000/3,412	%IncentiveGas * SiteEnergySavings * 10
Gas utility only	N/A	SiteEnergySavings * 10

Where:

- BSFC_{baseline} = Brake Specific Fuel (Gasoline) Consumption Factor (lbs/hp-hr)
= If unknown, use default values in the table below
- hp_{baseline} = Horsepower of the lawn equipment
= If unknown, use default values in the table below
- LF_{baseline} = The load factor is the average operational level of an engine as a fraction or

²⁵⁹ Residential cooling loadshape is used as an estimate of likely usage pattern for electric lawn equipment. This methodology is used in other jurisdictions offering electric lawn care equipment savings.

²⁶⁰ Consistent with coincidence factors found in: RLW Report: Final Report Coincidence Factor Study Residential Room Air Conditioners, June 23, 2008.

percentage of the engine manufacturer’s maximum rated horsepower. Load factor is difficult to characterize since it is a strong function of the equipment use and operation. Load factors for various equipment types are presented in the table below.

- Hours = Annual operating hours of the lawn or garden equipment.
= Values for various equipment types are presented in the table below.
- Fuel Density_{gasoline} = Gasoline fuel density (assume 6.15 lbs/gal)²⁶¹
- ED_{gasoline} = Energy density of gasoline (assume 115.83 MJ/gal)²⁶²
- ED_{electricity} = Energy density of electricity = 3.6 MJ/kWh
- EER_{G→E} = Energy Economy Ratio = 3.4 (for switching from gasoline to electricity)²⁶³
- 120,238 = Btu content in one gallon of finished gasoline²⁶⁴
- 1,000,000 = Btu to MMBtu conversion

Equipment Type	BSFC _{baseline} (lbs/hp-hr) ²⁶⁵	hp _{baseline} ²³⁴	LF _{baseline} ²³⁴	Hours (hrs/year) ²³⁴	ΔkWh	ΔMMBtu	Site Energy Savings (MMBtu)
Riding Lawn Mower	0.779	21.4	38%	36	-350.9	4.5	3.3
Push Lawn Mower	0.830	3.9	33%	25	-41.1	0.5	0.4
Leaf Blower	0.874	2.0	94%	10	-25.3	0.3	0.2
Trimmer	0.922	1.2	91%	9	-13.9	0.2	0.1
Chainsaw	0.770	1.9	70%	13	-20.5	0.3	0.2

SUMMER COINCIDENT PEAK DEMAND SAVINGS

$$\Delta kW = -1 * kW_{\text{battery draw}} * CF$$

Where:

kW_{battery draw} = The electric draw by the battery during charging. This varies based on the battery and charger specifications. If unknown use values in the table below.

Equipment Type	kW _{battery draw}
Riding Lawn Mower	0.57 ²⁶⁶
Push Lawn Mower	0.42 ²⁶⁷
Leaf Blower	0.20 ²³⁶
Trimmer	0.00 ²³⁶
Chainsaw	0.00 ²³⁶

²⁶¹ CARB (2022). CCI Emission Factor Database, “Fuel-Specific GHG” worksheet, available at [cci_emissionfactordatabase_2022-11-30.xlsx \(live.com\)](https://www.cci-emissionfactor.com/2022-11-30.xlsx).

²⁶² Ibid.

²⁶³ Energy Economy Ratio (EER) dimensionless value that represents the efficiency of a fuel as used in a powertrain as compared to a reference fuel used in the same powertrain. Source: CARB (2018), Low Carbon Fuel Standard Regulations: Table 5. EER Values for Fuels Used in Light- and Medium- Duty, and Heavy-Duty Applications. [RESO 18-34 LCFS Attachment A Final Reg Order \(ca.gov\)](https://www.ca.gov/regaffairs/REG-2018-01-01-02-03-04-05-06-07-08-09-10-11-12-13-14-15-16-17-18-19-20-21-22-23-24-25-26-27-28-29-30-31-32-33-34-35-36-37-38-39-40-41-42-43-44-45-46-47-48-49-50-51-52-53-54-55-56-57-58-59-60-61-62-63-64-65-66-67-68-69-70-71-72-73-74-75-76-77-78-79-80-81-82-83-84-85-86-87-88-89-90-91-92-93-94-95-96-97-98-99-100-101-102-103-104-105-106-107-108-109-110-111-112-113-114-115-116-117-118-119-120-121-122-123-124-125-126-127-128-129-130-131-132-133-134-135-136-137-138-139-140-141-142-143-144-145-146-147-148-149-150-151-152-153-154-155-156-157-158-159-160-161-162-163-164-165-166-167-168-169-170-171-172-173-174-175-176-177-178-179-180-181-182-183-184-185-186-187-188-189-190-191-192-193-194-195-196-197-198-199-200-201-202-203-204-205-206-207-208-209-210-211-212-213-214-215-216-217-218-219-220-221-222-223-224-225-226-227-228-229-230-231-232-233-234-235-236-237-238-239-240-241-242-243-244-245-246-247-248-249-250-251-252-253-254-255-256-257-258-259-260-261-262-263-264-265-266-267-268-269-270-271-272-273-274-275-276-277-278-279-280-281-282-283-284-285-286-287-288-289-290-291-292-293-294-295-296-297-298-299-300-301-302-303-304-305-306-307-308-309-310-311-312-313-314-315-316-317-318-319-320-321-322-323-324-325-326-327-328-329-330-331-332-333-334-335-336-337-338-339-340-341-342-343-344-345-346-347-348-349-350-351-352-353-354-355-356-357-358-359-360-361-362-363-364-365-366-367-368-369-370-371-372-373-374-375-376-377-378-379-380-381-382-383-384-385-386-387-388-389-390-391-392-393-394-395-396-397-398-399-400-401-402-403-404-405-406-407-408-409-410-411-412-413-414-415-416-417-418-419-420-421-422-423-424-425-426-427-428-429-430-431-432-433-434-435-436-437-438-439-440-441-442-443-444-445-446-447-448-449-450-451-452-453-454-455-456-457-458-459-460-461-462-463-464-465-466-467-468-469-470-471-472-473-474-475-476-477-478-479-480-481-482-483-484-485-486-487-488-489-490-491-492-493-494-495-496-497-498-499-500-501-502-503-504-505-506-507-508-509-510-511-512-513-514-515-516-517-518-519-520-521-522-523-524-525-526-527-528-529-530-531-532-533-534-535-536-537-538-539-540-541-542-543-544-545-546-547-548-549-550-551-552-553-554-555-556-557-558-559-560-561-562-563-564-565-566-567-568-569-570-571-572-573-574-575-576-577-578-579-580-581-582-583-584-585-586-587-588-589-590-591-592-593-594-595-596-597-598-599-600-601-602-603-604-605-606-607-608-609-610-611-612-613-614-615-616-617-618-619-620-621-622-623-624-625-626-627-628-629-630-631-632-633-634-635-636-637-638-639-640-641-642-643-644-645-646-647-648-649-650-651-652-653-654-655-656-657-658-659-660-661-662-663-664-665-666-667-668-669-670-671-672-673-674-675-676-677-678-679-680-681-682-683-684-685-686-687-688-689-690-691-692-693-694-695-696-697-698-699-700-701-702-703-704-705-706-707-708-709-710-711-712-713-714-715-716-717-718-719-720-721-722-723-724-725-726-727-728-729-730-731-732-733-734-735-736-737-738-739-740-741-742-743-744-745-746-747-748-749-750-751-752-753-754-755-756-757-758-759-760-761-762-763-764-765-766-767-768-769-770-771-772-773-774-775-776-777-778-779-780-781-782-783-784-785-786-787-788-789-790-791-792-793-794-795-796-797-798-799-800-801-802-803-804-805-806-807-808-809-810-811-812-813-814-815-816-817-818-819-820-821-822-823-824-825-826-827-828-829-830-831-832-833-834-835-836-837-838-839-840-841-842-843-844-845-846-847-848-849-850-851-852-853-854-855-856-857-858-859-860-861-862-863-864-865-866-867-868-869-870-871-872-873-874-875-876-877-878-879-880-881-882-883-884-885-886-887-888-889-890-891-892-893-894-895-896-897-898-899-900-901-902-903-904-905-906-907-908-909-910-911-912-913-914-915-916-917-918-919-920-921-922-923-924-925-926-927-928-929-930-931-932-933-934-935-936-937-938-939-940-941-942-943-944-945-946-947-948-949-950-951-952-953-954-955-956-957-958-959-960-961-962-963-964-965-966-967-968-969-970-971-972-973-974-975-976-977-978-979-980-981-982-983-984-985-986-987-988-989-990-991-992-993-994-995-996-997-998-999-1000)

²⁶⁴ [Energy conversion calculators - U.S. Energy Information Administration \(EIA\)](https://www.eia.gov/energy-conversion-calculators)

²⁶⁵ CARB (2022). CCI Emission Factor Database, “Fuel-Specific GHG” worksheet, available at [cci_emissionfactordatabase_2022-11-30.xlsx \(live.com\)](https://www.cci-emissionfactor.com/2022-11-30.xlsx).

²⁶⁶ Vermont Act 56 Tier III Technical Advisory Group 2021 ANNUAL REPORT

²⁶⁷ Massachusetts Residential Baseline Study, Guidehouse, 2020

CF = Summer Peak Coincidence Factor
 = 30%²⁶⁸

WATER AND OTHER NON-ENERGY IMPACT DESCRIPTIONS AND CALCULATION

N/A

DEEMED O&M COST ADJUSTMENT CALCULATION

N/A

COST EFFECTIVENESS SCREENING AND LOAD REDUCTION FORECASTING WHEN FUEL SWITCHING

This measure can involve fuel switching from fossil fuel to electric.

For the purposes of forecasting load reductions due to fuel switch projects per Section 16-111.5B, changes in site energy use at the customer’s meter (using ΔkWh algorithm below) adjusted for utility line losses (at-the-busbar savings), customer switching estimates, NTG, and any other adjustment factors deemed appropriate, should be used.

The inputs to cost effectiveness screening should reflect the actual impacts on the electric and fuel consumption at the customer meter and, for fuel switching measures, this will not match the output of the calculation/allocation methodology presented in the “Electric Energy Savings” and “Fossil Fuel Savings” sections above. Therefore in addition to the calculation of savings claimed, the following values should be used to assess the cost effectiveness of the measure.

$$\Delta\text{Therms} = [\text{Gas Consumption Replaced}]$$

$$= (\text{BSFC}_{\text{baseline}} * \text{hp}_{\text{baseline}} * \text{LF}_{\text{baseline}} * \text{Hours}) / (\text{Fuel Density}_{\text{gasoline}}) * 120,238/100,000$$

$$\Delta\text{kWh} = [\text{Electric Consumption Added}]$$

$$= (\text{BSFC}_{\text{baseline}} * \text{hp}_{\text{baseline}} * \text{LF}_{\text{baseline}} * \text{Hours}) / (\text{Fuel Density}_{\text{gasoline}}) * \text{ED}_{\text{gasoline}} / (\text{ED}_{\text{electricity}} * \text{EER}_{\text{G} \rightarrow \text{E}})$$

MEASURE CODE: RS-APL-ELGE-V01-240101

REVIEW DEADLINE: 1/1/2028

²⁶⁸ Consistent with coincidence factors found in: RLW Report: Final Report Coincidence Factor Study Residential Room Air Conditioners, June 23, 2008.

5.1.17 ENERGY STAR All-in-One Clothes Washer-Dryer

DESCRIPTION

This measure relates to the installation of a residential combination all-in-one clothes washer-dryer meeting the ENERGY STAR criteria. ENERGY STAR qualified combination all-in-one clothes washer-dryers save energy through a combination of more efficient drying and reduced runtime of the drying cycle. More efficient washing and drying is achieved through heat pump technology, modifying operating conditions such as air flow and/or heat input rate, improving air circulation through better drum design, and improving efficiency of motors. ENERGY STAR provides criteria for electric clothes washer-dryers with heat pump technology.

This measure was developed to be applicable to the following program types: Time of Sale, New Construction, Retrofit. If applied to other program types, the measure savings should be verified.

DEFINITION OF EFFICIENT EQUIPMENT

All-in-one clothes washer-dryer must meet the ENERGY STAR or ENERGY STAR Most Efficient criteria, as required by the program. Units utilizing the Heat Pump designation must meet the same ENERGY STAR criteria and be classified as Heat Pump units.

DEFINITION OF BASELINE EQUIPMENT

The baseline condition for a washing cycle is a clothes washer meeting the minimum federal baseline as of January 2018²⁶⁹.

Federal Standard	≥1.57 IMEF, ≤6.5 IWF	≥1.84 IMEF, ≤4.7 IWF
------------------	----------------------	----------------------

The baseline condition used for a washing cycle for this measure is a weighted average of 1.7 IMEF.²⁷⁰

The baseline condition for a drying cycle is a clothes dryer meeting the minimum federal requirements for units manufactured on or after January 1, 2015.

Efficiency Level	Front Loading ≥4.5 Cu ft
Federal Standard for Clothes Dryer	3.11 ²⁷¹ CEF for Vented Electric, 2.84 ²⁷² CEF for Vented Gas

DEEMED LIFETIME OF EFFICIENT EQUIPMENT

The expected measure life is assumed to be 14 years²⁷³.

DEEMED MEASURE COST

The average cost of the ENERGY STAR combination all-in-one clothes washer-dryer \$2,331 with no additional installation cost for a total measure cost of \$2,331.²⁷⁴

²⁶⁹DOE Energy Conservation Standards for Clothes Washers, Appliance and Equipment Standard, 10 CFR Part 430.32(g)

²⁷⁰ Weighted average IMEF of Federal Standard rating for Front Loading and Top Loading units. Weighting is based upon the relative top v front loading percentage of available non-ENERGY STAR product in the CEC database (products accessed on 04/21/2022).

²⁷¹ ENERGY STAR Draft 2 Version 1.0 Clothes Dryers Data and Analysis

²⁷² Federal standards report CEF for gas clothes dryers in terms of lbs/kWh. To determine gas savings, this number is later converted to therms.

²⁷³ Lifetime of 14 years per Residential Clothes Washers Life-Cycle Cost Analysis Spreadsheet posted by the Energy Efficiency and Renewable Energy Office on Sep 23, 2021.

²⁷⁴ The cost of buying a new market available all-in-one clothes washer-dryer with HP technology from Home Depot have been

For a non-IQ participant, the incremental cost is assumed to be \$1,328.²⁷⁵

For an IQ participant, the incremental cost is assumed to be \$1,224.²⁷⁶

LOADSHAPE

Loadshape R17 - Residential Electric Dryer

COINCIDENCE FACTOR

The coincidence factor for this measure is 3.8%.²⁷⁷

Algorithm

CALCULATION OF ENERGY SAVINGS

ELECTRIC ENERGY SAVINGS

Non Fuel Switch Measures

$$\Delta kWh_{total}^{278} = \Delta kWh_{clothes\ washer} + \Delta kWh_{dryer}$$

$$\Delta kWh_{clothes\ washer} = [Capacity * IQAdj_{CW} / IMEF_{base} * Ncycles * (\%CW_{base} + (\%DHW_{base} * \%Electric_DHW))] - [Capacity * 1 / IMEF_{eff} * Ncycles * (\%CWeff + (\%DHW_{eff} * \%Electric_DHW))]$$

$$\Delta kWh_{dryer} = ((Load / CE_{base} * IQAdj_D) - Load / CE_{eff}) * Ncycles * \%Electric$$

Fuel Switch/Electrification Measures

Total Site Energy Savings (MMBTUs) = Site Energy Savings (MMBTUs)_{clothes washer} + Site Energy Savings (MMBTUs)_{dryer}

Break out savings calculated for the washing cycle for a baseline clothes washer with gas DHW replaced with an all-in-one clothes washer-dryer with electric DHW

$$SiteEnergySavings(MMBTUs)_{clothes\ washer} = [(NonFuelConsumption_{Baseline\ clothes\ washer} + GasConsumption_{Baseline\ clothes\ washer}) - EfficientConsumption_{efficient\ clothes\ washer}]$$

$$ElectricConsumption^{279}_{Baseline\ clothes\ washer} = [Capacity * IQAdj_{CW} / IMEF_{base} * Ncycles * \%CW_{base} * MMBtu_convert]$$

$$GasConsumption_{Baseline\ clothes\ washer} = [Capacity * IQAdj_{CW} / IMEF_{base} * Ncycles * (\%DHW_{base} * \%Fossil_DHW * R_{eff}) * MMBtu_convert]$$

averaged for three different manufacturers. These products are ENERGY STAR certified. See “Incremental Cost R&D.xls” for information.

²⁷⁵ The baseline cost is assumed to be the cost of a standard efficiency clothes washer in addition to the cost of a standard efficiency clothes dryer. A standard clothes washer cost (\$763.98) is based on analysis of cost data provided in the Retail Price Data from DOE Analytical Tool (Lifecycle Cost and Payback Period Analysis) for Negotiated Standards, 2017, and weighted by a market share of 49.4% Top-Loading to 50.6% Front-Loading machines. The cost of a standard dryer (\$564) is from “ACEEE Clothes Dryers.pdf.”

²⁷⁶ IQ Incremental costs factor in the assumption that a secondhand unit costs on average 50% of a new baseline unit, and that 1/3 of IQ participants would have purchased a unit on the secondhand market. See “IQ Appliance Calculations.xls” for information.

²⁷⁷ Calculated from Itron eShapes, 8760 hourly data by end use for Missouri, as provided by Ameren.

²⁷⁸ The energy savings algorithm from the clothes dryer and clothes washer has been calculated individually to create the final algorithm for the Energy Star Combination All-in-One Clothes Washer-Dryer. The dryer section from the clothes washer algorithm has been excluded. See “Energy Star Combination All-in-One Clothes Washer-Dryer Calculations.xls” for information.

²⁷⁹ Electric consumption that accounts for the fact that some of the consumption on gas DHW Clothes Washer comes from electricity (motors, controls, etc).

$$\text{ElectricConsumption}_{\text{efficient clothes washer}} = [\text{Capacity} * 1/\text{IMEF}_{\text{eff}} * \text{Ncycles} * (\% \text{CW}_{\text{base}} + (\% \text{DHW}_{\text{base}} * \% \text{Electric_DHW})) * \text{MMBtu_convert}]$$

Break out savings calculated for the drying cycle for a baseline gas dryer replaced with an all-in-one clothes washer-dryer.

$$\text{Site Energy Savings (MMBTUs)}_{\text{dryer}}^{278} = [\text{FuelSwitchSavings}_{\text{dryer}}] + [\text{NonFuelSwitchSavings}_{\text{dryer}}]$$

$$\text{FuelSwitchSavings}_{\text{dryer}} = [\text{Load}/\text{CEF}_{\text{baseGas}} * \text{IQAdj}_D * \text{Ncycles} * \text{MMBtu_convert} * \% \text{Gas}_{\text{Gas}}] - [\text{Load}/\text{CEF}_{\text{effElec}} * \text{Ncycles} * \text{MMBtu_convert} * \% \text{Gas}_{\text{Gas}}]$$

$$\text{NonFuelSwitchSavings}_{\text{dryer}} = [\text{Load}/\text{CEF}_{\text{baseGas}} * \text{IQAdj}_D * \text{Ncycles} * \text{MMBtu_convert} * \% \text{Electric}_{\text{Gas}}] - [\text{Load}/\text{CEF}_{\text{effElec}} * \text{Ncycles} * \text{MMBtu_convert} * \% \text{Electric}_{\text{Gas}}]$$

If Total Site Energy Savings (MMBTUs) calculated above is positive, the measure is eligible.

The appropriate savings claim is dependent on which utilities are supporting the measure as provided in a table below:

Measure supported by:	Electric Utility claims (kWh):	Gas Utility claims (therms):
Electric utility only	SiteEnergySavings * 1,000,000/3,412	N/A
Gas utility only	N/A	SiteEnergySavings * 10

Where:

- Capacity = Unit capacity (cubic feet)
= Actual. If capacity is unknown assume 4.9 cubic feet²⁸⁰
- IMEFbase = Integrated Modified Energy Factor of baseline clothes washer unit
= 1.71²⁸¹
- IQAdj_{cw} = Baseline consumption adjustment for IQ program participants to account for a portion of participants who would have utilized the secondary market.²⁸²
= 1.02 if IQ, 1.0 if non-IQ
- IMEF_{eff} = Integrated Modified Energy Factor of Efficient Combination All-in-One Washer-Dryer unit
= Actual. If unknown assume average values provided below.

²⁸⁰ Average of ENERGY STAR & ENERGY STAR MOST EFFICIENT Residential Combination All-in-One Washer-Dryer. April 2024. <https://www.energystar.gov/productfinder/product/certified-clothes-washers>.

²⁸¹ Weighted average IMEF of Federal Standard rating for Front Loading and Top Loading units. Weighting is based upon the relative top v front loading percentage of available non-ENERGY STAR product in the CEC database (products accessed on 04/21/2022).

²⁸² It is assumed that a second-hand unit is on average 2/3 of a measure’s EUL years old (9 years). The baseline consumption of a unit meeting the pre 03/2015 Federal Standard was increased by an estimate of 0.4% * 9 years (based on review of the refrigerator/freezer regression algorithm used in the 5.1.8 Refrigerator and Freezer Recycling measure) to account for degradation of performance over time. For 2025 on, the post 03/2015 Federal Standard is utilized. This second hand consumption was then weighted 1/3: 2/3 current new baseline to estimate a multiplier for IQ participants. See “IQ Appliance Calculations.xls” for information.

Efficiency Class	IMEF _{eff} ²⁸³
ENERGY STAR	2.76
ENERGY STAR Most Efficient	2.92

Ncycles = Number of cycles per year
 = 276²⁸⁴

%CW = Percentage of total energy consumption for Clothes Washer operation (different for baseline and efficient unit – see table below)

%DHW = Percentage of total energy consumption used for water heating (different for baseline and efficient unit – see table below)

	Percentage of Total Energy Consumption of Clothes Washer ²⁸⁵	
	%CW	%DHW
Baseline	6.7%	15.8%
Efficient	6.6%	13.0%

%Electric_DHW = Percentage of DHW savings assumed to be electric
 = 100 % for Electric
 = 0 % for Fossil Fuel
 = If unknown²⁸⁶, use the following table:

Utility	Location				
	Single Family	Single Family Low Income	Multi Family	Multi Family Low Income	Unknown
Ameren ²⁸⁷	24%	25%	40%	43%	28%
ComED ²⁸⁸	8%		11%		9%
People’s Gas ²⁸⁹	2.0%	2.0%	1.7%	2.1%	2.0%
Northshore Gas ²⁹⁰	1.3%	1.8%	10.0%	2.4%	2.3%

²⁸³ The energy measurements are performed at an ISO/IEC accredited lab as specified in the application process for the ENERGY STAR & ENERGY STAR Most Efficient. Approved products on the [ENERGY STAR Qualified Products List 2024-04-23](#) have IMEF, IWF values listed for clothes washer and CEF values for clothes dryer.

²⁸⁴ Loads per week was estimated by taking the weighted average of the number of loads per week (midpoint used where loads per week is a range and the weights are the share of respondents falling into each number of loads per week response bin). This estimate was scaled to an IL-specific value by applying a ratio developed using the 2009 state specific values for the states in the East North Central portion of the Midwest Region. This value was then scaled to apply to a consistent amount of laundry washed over time.

²⁸⁵ The percentage of total energy consumption that is used for the machine, heating the hot water or by the dryer is different depending on the efficiency of the unit. Values are based on a weighted average of top loading and front loading units based on data from the 2017 DOE Life-Cycle Cost and Payback Period Excel-based analytical tool. See “IL TRM_CW Analysis_082024.xlsx” for the calculation.

²⁸⁶ Based on the average % electricity used for water heating in Unknown residential structure types across all utilities covered by the IL program. Residence types include: SF, SF LI, MF & MF LI. Utilities included: Ameren, ComEd, People’s Gas, Northshore Gas & Nicor. Please see subsequent table and citations for specific sources.

²⁸⁷ Provided by AEG from the 2020 Market Potential Study completed for AIC, as well as AIC Income Qualified Initiative: 2021 Participant Survey Results Memo (February 1, 2022) p. 17.

²⁸⁸ Commonwealth Edison Residential Baseline Study (2020). p.4.4 & 4.19; Section 4-7 Water Heating. Prepared by Itron.

²⁸⁹ Implementation Contractors data from Peoples Gas and North Shore Gas for PY2022-2023.

²⁹⁰ Ibid.

Utility	Location				
	Single Family	Single Family Low Income	Multi Family	Multi Family Low Income	Unknown
Nicor Gas ²⁹¹	1.3%	1.8%	10.0%	2.4%	2.3%
All DUs²⁹²					25%

Note: If a measure is supported by a gas and electric utility through a joint program, and it is unknown whether the participant has a gas supply, the electric utility values in the table above should be used. If it is known that the participant has a gas supply, the values from the gas utility above should be applied.

Load = The average total weight (lbs) of clothes per drying cycle. If unit size is unknown, assume standard.

Unit Size	Load (lbs) ²⁹³
Standard	8.45

CEFBASE = Combined energy factor (CEF) (lbs/kWh) of the baseline unit is based on existing federal standards energy factor as performed in the ENERGY STAR analysis²⁷¹. If product class unknown, assume electric, standard.

Product Class	CEFBASE (lbs/kWh)
Vented Electric, Standard (≥ 4.4 ft3)	3.11
Vented Gas	2.84 ²⁷²

IQAdj_b = Baseline consumption adjustment for IQ program participants to account for a portion of participants who would have utilized the secondary market.²⁹⁴
 = 1.033 if IQ, 1.0 if non-IQ

CEFEff = CEF (lbs/kWh) of ENERGY STAR or ENERGY STAR Most Efficient requirements Combination All-in-One Washer-Dryer.
 = Actual. If unknown assume values provided below.

Efficiency Class	CEFEff (lbs/kWh) ²⁸³
ENERGY STAR	4.97
ENERGY STAR Most Efficient	6.9

%Electric = The percent of overall savings coming from electricity.

²⁹¹ Comparable service area & customers to NSG, therefore using their survey data.

²⁹² For the weighted average calculations, please see the Analysis file. PGL, NSG, Nicor & gas customers were assumed to follow the provided split. ComEd total customers, minus overlap with PGL, NSG & Nicor, therefore electric only homes. Ameren is total customers minus Nicor.

²⁹³ Based on ENERGY STAR test procedures

²⁹⁴ It is assumed that a second-hand unit is on average 2/3 of a measure’s EUL years old (11 years). The current Federal Standard became effective in 2015 so the previous standard is used to estimate base consumption for a second hand unit, and further increased by an estimate of 0.4% * 11 years (based on review of the refrigerator/freezer regression algorithm used in the 5.1.8 Refrigerator and Freezer Recycling measure) to account for degradation of performance over time. This second hand consumption was then weighted 1/3: 2/3 current new baseline to estimate a multiplier for IQ participants. See “IQ Appliance Calculations.xls” for information.

= 100% for electric dryers, 16% for gas dryers²⁹⁵.

%Fossil_DHW

= Percentage of DHW savings assumed to be Fossil Fuel

= 100 % for Fossil fuel

= 0 % for Electric

= If unknown²⁹⁶, use the following table:

Utility	Location				
	Single Family	Single Family Low Income	Multi Family	Multi Family Low Income	Unknown
Ameren ²⁹⁷	76%	75%	60%	57%	72%
ComED ²⁹⁸	92%		89%		91%
People’s Gas ²⁹⁹	97.9%	98.0%	98.3%	97.6%	97.8%
Northshore Gas ³⁰⁰	98.5%	98.2%	90.0%	97.6%	97.6%
Nicor Gas ³⁰¹	98.5%	98.2%	90.0%	97.6%	97.6%
All DUs ³⁰²					75%

Note: If a measure is supported by a gas and electric utility through a joint program, and it is unknown whether the participant has a gas supply, the electric utility values in the table above should be used. If it is known that the participant has a gas supply, the values from the gas utility above should be applied.

R_eff

= Recovery efficiency factor

=1.26³⁰³

MMBtu_convert

= Conversion factor from kWh to MMBtu.

= 0.003412

%Gas

= Percent of overall savings coming from gas.

= 0% for electric dryers and 84% for gas dryers³⁰⁴.

²⁹⁵ %Electric accounts for the fact that some of the savings on gas dryers comes from electricity (motors, controls, etc). 16% was determined using a ratio of the electric to total savings from gas dryers given by ENERGY STAR Draft 2 Version 1.0 Clothes Dryers Data and Analysis.

²⁹⁶ Based on the average % electricity used for water heating in Unknown residential structure types across all utilities covered by the IL program. Residence types include: SF, SF LI, MF & MF LI. Utilities included: Ameren, ComEd, People’s Gas, Northshore Gas & Nicor. Please see subsequent table and citations for specific sources.

²⁹⁷ Provided by AEG from the 2020 Market Potential Study completed for AIC, as well as AIC Income Qualified Initiative: 2021 Participant Survey Results Memo (February 1, 2022) p. 17.

²⁹⁸ Commonwealth Edison Residential Baseline Study (2020). p.4.4 & 4.19; Section 4-7 Water Heating. Prepared by Itron.

²⁹⁹ Implementation Contractors data from Peoples Gas and North Shore Gas for PY2022-2023.

³⁰⁰ Ibid.

³⁰¹ Comparable service area & customers to NSG, therefore using their survey data.

³⁰² For the weighted average calculations, please see the Analysis file. PGL, NSG, Nicor & gas customers were assumed to follow the provided split. ComEd total customers, minus overlap with PGL,NSG & Nicor, therefore gas only homes. Ameren is total customers minus Nicor.

³⁰³ To account for the different efficiency of electric and Natural Gas hot water heaters (gas water heater: recovery efficiencies ranging from 0.74 to 0.85 (0.78 used), and electric water heater with 0.98 recovery efficiency (see ENERGY STAR Waste Water Recovery Guidelines). Therefore a factor of 0.98/0.78 (1.26) is applied.

³⁰⁴ %Gas accounts for the fact that some of the savings on gas dryers comes from electricity (motors, controls, etc). 84% was determined using a ratio of the gas to total savings from gas dryers given by ENERGY STAR Draft 2 Version 1.0 Clothes Dryers Data and Analysis.

For example:

Non Fuel Switch example, for a non- IQ Time of Sale, standard, ventless, ENERGY STAR All-in-One Clothes Washer-Dryer:

$$\Delta kWh_{total} = \Delta kWh_{clothes\ washer} + \Delta kWh_{dryer}$$

$$\Delta kWh_{clothes\ washer} = [Capacity * 1/IMEF_{base} * Ncycles * (\%CW_{base} + (\%DHW_{base} * \%Electric_DHW))] - [Capacity * 1/IMEF_{eff} * Ncycles * (\%CW_{eff} + (\%DHW_{eff} * \%Electric_DHW))]$$

$$\Delta kWh_{dryer} = ((Load/CE_{Fbase} * IQ_{Adj}) - Load/CE_{Feff}) * Ncycles * \%Electric$$

ENERGY STAR

$$\begin{aligned} \Delta kWh_{clothes\ washer} &= (4.9 * 1/1.71 * 276 * (6.7\% + (15.8\% * 100\%))) - (4.9 * 1/2.76 * 276 * (6.6\% + (13\% * 100\%))) \\ &= 81.9\ kWh \end{aligned}$$

$$\begin{aligned} \Delta kWh_{dryer} &= ((8.45/3.11 * 1) - 8.45/4.97) * 276 * 100\% \\ &= 280.6\ kWh \end{aligned}$$

$$\begin{aligned} \Delta kWh_{Total} &= 280.6 + 81.9 \\ &= 363\ kWh \end{aligned}$$

ENERGY STAR Most Efficient/CEE Tier 2

$$\begin{aligned} \Delta kWh_{clothes\ washer} &= (4.9 * 1/1.71 * 276 * (6.7\% + (15.8\% * 100\%))) - (4.9 * 1/2.92 * 276 * (6.6\% + (13\% * 100\%))) \\ &= 87.2\ kWh \end{aligned}$$

$$\begin{aligned} \Delta kWh_{dryer} &= ((8.45/3.11 * 1) - 8.45/6.9) * 276 * 100\% \\ &= 411.9\ kWh \end{aligned}$$

$$\begin{aligned} \Delta kWh_{Total} &= 411.9 + 87.2 \\ &= 499\ kWh \end{aligned}$$

Fuel switch example, for a Time of Sale, an ENERGY STAR All-in-One Clothes Washer-Dryer in place of a clothes washer with gas DHW and vented gas dryer:

$$Total\ SiteEnergySavings\ (MMBTUs) = SiteEnergySavings\ (MMBTUs)_{clothes\ washer} + SiteEnergySavings\ (MMBTUs)_{dryer}$$

$$SiteEnergySavings\ (MMBTUs)_{clothes\ washer} = [(NonFuelConsumption_{Baseline\ clothes\ washer} + GasConsumption_{Baseline\ clothes\ washer}) - EfficientConsumption_{efficient\ clothes\ washer}]$$

$$NonFuelConsumption_{clothes\ washer} = [(Capacity * 1/IMEF_{base} * Ncycles * ((\%CW_{base} + \%Electric_DHW) * MMBtu_convert)]$$

$$= (4.9 * 1/1.71 * 276 * (6.7\% + (15.8\% * 0\%)) * 0.003412)$$

$$= 0.18 \text{ MMBTU}$$

$$\text{GasConsumption}_{\text{Baseline clothes washer}} = [\text{Capacity} * 1/\text{IMEF}_{\text{base}} * \text{Ncycles} * (\% \text{DHW}_{\text{base}} * \% \text{Fossil_DHW} * \text{R_eff}) * \text{MMBtu_convert}]$$

$$= (4.9 * 1/1.71 * 276 * (15.8\% * 1 * 1.26)) * 0.003412$$

$$= 0.54 \text{ MMBTU}$$

$$\text{EfficientConsumption}_{\text{efficient clothes washer}} = [\text{Capacity} * 1/\text{IMEF}_{\text{base}} * \text{Ncycles} * (\% \text{CW}_{\text{base}} + (\% \text{DHW}_{\text{base}} * \% \text{Electric_DHW})) * \text{MMBtu_convert}]$$

$$= (4.9 * 1/2.8 * 276 * (6.6\% + (13\% * 100\%))) * 0.003412$$

$$= 0.32 \text{ MMBTU}$$

$$\text{SiteEnergySavings (MMBTUs)}_{\text{clothes washer}}$$

$$= (0.18 + 0.54) - 0.32$$

$$= 0.40 \text{ MMBTU}$$

$$\text{SiteEnergySavings (MMBTUs)}_{\text{dryer}} = [\text{FuelSwitchSavings}_{\text{dryer}}] + [\text{NonFuelSwitchSavings}_{\text{dryer}}]$$

$$\text{FuelSwitchSavings}_{\text{dryer}} = [\text{Load}/\text{CEF}_{\text{baseGas}} * \text{IQAdj} * \text{Ncycles} * \text{MMBtu_convert} * \% \text{Gas}_{\text{Gas}}] - [\text{Load}/\text{CEFF}_{\text{Elec}} * \text{Ncycles} * \text{MMBtu_convert} * \% \text{Gas}_{\text{Gas}}]$$

$$= (8.45/2.84 * 1 * 276 * 0.003412 * 84\%) - (8.45/4.97 * 276 * 0.003412 * 84\%)$$

$$= 1.01 \text{ MMBTU}$$

$$\text{NonFuelSwitchSavings}_{\text{dryer}} = [\text{Load}/\text{CEF}_{\text{baseGas}} * \text{IQAdj} * \text{Ncycles} * \text{MMBtu_convert} * \% \text{Electric}_{\text{Gas}}] - [\text{Load}/\text{CEFF}_{\text{Elec}} * \text{Ncycles} * \text{MMBtu_convert} * \% \text{Electric}_{\text{Gas}}]$$

$$= (8.45/2.84 * 1 * 276 * 0.003412 * 16\%) - (8.45/4.97 * 276 * 0.003412 * 16\%)$$

$$= 0.19 \text{ MMBTU}$$

$$\text{SiteEnergySavings (MMBTUs)}_{\text{dryer}}$$

$$= 1.01 + 0.19$$

$$= 1.2 \text{ MMBTU}$$

$$\text{Total SiteEnergySavings (MMBTUs)} = \text{SiteEnergySavings (MMBTUs)}_{\text{dryer}} + \text{SiteEnergySavings (MMBTUs)}_{\text{clothes washer}}$$

$$= 0.40 + 1.2$$

$$= 1.6 \text{ MMBTU}$$

If supported by an electric utility: $\Delta \text{kWh} = \Delta \text{Total SiteEnergySavings (MMBTUs)} * 1,000,000 / 3,412$

$$= 1.6 * 1,000,000 / 3,412$$

$$= 469 \text{ kWh}$$

If supported by a gas utility: $\Delta\text{Therms} = \Delta\text{Total SiteEnergySavings(MMBTUs)} * 10$
 $= 1.6 * 10$
 $= 16 \text{ Therms}$

SUMMER COINCIDENT PEAK DEMAND SAVINGS

$$\Delta kW_{\text{Total}}^{305} = ((\Delta kWh_{\text{clothes washer}} + \Delta kWh_{\text{dryer}}) / \text{Hours}) * CF$$

Where:

- $\Delta kWh_{\text{clothes washer}}$ = Energy Savings as calculated above for clothes washer. Note: do not include the secondary savings in this calculation.
- Hours = Assumed run hours of unit
= 630 hours³⁰⁶
- $\Delta kWh_{\text{dryer}}$ = Energy Savings as calculated above for dryer. Note: do not include the secondary savings in this calculation.
- CF = Summer Peak Coincidence Factor for measure.
= 0.038²⁷⁷

For example, for a Time of Sale, an ENERGY STAR All-in-One Clothes Washer-Dryer

ENERGY STAR

$$\Delta kW = ((81.9 + 280.6) / 630) * 0.038$$

$$= 0.02 \text{ kW}$$

FOSSIL FUEL SAVINGS

Calculation provided together with Electric Energy Savings above.

WATER AND OTHER NON-ENERGY IMPACT DESCRIPTIONS AND CALCULATION

$$\Delta\text{Water (gallons)} = \text{Capacity} * ((IWF_{\text{base}} * IQ_{\text{AdjWater}}) - IWF_{\text{eff}}) * \text{Ncycles}$$

Where:

- $\Delta\text{Water (gallons)}$ = Water saved, in gallons
- IWFbase = Integrated Water Factor of baseline clothes washer
= 5.59³⁰⁷
- IQ_{AdjWater} = Baseline water consumption adjustment for IQ program participants to account for a portion of participants who would have utilized the secondary

³⁰⁵ The peak energy savings algorithm from the clothes dryer and clothes washer has been calculated individually to create the final algorithm for the Energy Star Combination All-in-One Clothes Washer-Dryer. The dryer section from the clothes washer algorithm has been excluded. See “Energy Star Combination All-in-One Clothes Washer-Dryer Calculations.xls” for information.

³⁰⁶ Based on an average of reported cycle times for a normal load of models on the ENERGY STAR QPL.

³⁰⁷ Weighted average IWF of Federal Standard rating for Front Loading and Top Loading units. Weighting is based upon the relative top v front loading percentage of available non-ENERGY STAR product in the CEC database (products accessed on 04/21/2022).

market.³⁰⁸
 =1.02 if IQ, 1.0 if non-IQ
 IWFeff = Water Factor of Efficient Combination All-in-One Washer-Dryer unit
 = Actual. If unknown assume average values provided below

Using the default assumptions provided above, the prescriptive water savings for each efficiency level are presented below:

Efficiency Class	IWFeff ²⁸³	ΔWater ³⁰⁹ (gallons per year)
ENERGY STAR	3.1	3,367.5
ENERGY STAR Most Efficient	2.9	3,638.0

Other factors as defined above.

For example, for a non- IQ Time of Sale, standard, ventless, ENERGY STAR All-in-One Clothes Washer-Dryer:

ENERGY STAR

$$\Delta\text{Water} = 4.9 * ((5.59 * 1) - 3.10) * 276$$

$$= 3,367.5 \text{ Gallons per year}$$

ENERGY STAR Most Efficient/CEE Tier 2

$$\Delta\text{Water} = 4.9 * ((5.59 * 1) - 2.9) * 276$$

$$= 3,638.0 \text{ Gallons per year}$$

Secondary kWh Savings for Clothes Washer Water Supply and Wastewater Treatment

The following savings should be included in the total savings for this measure but should not be included in TRC tests to avoid double counting the economic benefit of water savings.

$$\Delta\text{kWh}_{\text{water}} = \Delta\text{Water (gallons)} / 1,000,000 * E_{\text{water total}}$$

Where:

ΔWater (gallons) = Water saved, in gallons – as calculated below.

$$E_{\text{water total}} = \text{IL Total Water Energy Factor (kWh/Million Gallons)}$$

$$= 5010^{310}$$

³⁰⁸ It is assumed that a second-hand unit is on average 2/3 of a measure’s EUL years old (9 years). The baseline consumption from the TRM in 2015 is assumed the second hand water consumption (note we do not assume a degradation over time for water consumption) was then weighted 1/3: 2/3 current new baseline to estimate a multiplier for IQ participants. See “IQ Appliance Calculations.xls” for information.

³⁰⁹ Baseline clothes washer capacity is assumed to have 4.9 cu.ft. with 233 wash cycles for clothes washer.

³¹⁰ This factor includes 2571 kWh/MG for water supply based on Illinois energy intensity data from a 2012 ISAWWA study and 2439 kWh/MG for wastewater treatment based on national energy intensity use estimates. For more information, please review Elevate Energy’s ‘IL TRM: Energy per Gallon Factor, May 2018 paper’.

For example, for a non- IQ Time of Sale, standard, ventless, ENERGY STAR All-in-One Clothes Washer-Dryer:

ENERGY STAR

$$\begin{aligned} \Delta kWh_{water} &= 3367.5/1,000,000 * 5,010 \\ &= 16.9 \text{ kWh} \end{aligned}$$

ENERGY STAR Most Efficient/CEE Tier 2

$$\begin{aligned} \Delta kWh_{water} &= 3638.0/1,000,000 * 5,010 \\ &= 18.2 \text{ kWh} \end{aligned}$$

DEEMED O&M COST ADJUSTMENT CALCULATION

N/A

COST EFFECTIVENESS SCREENING AND LOAD REDUCTION FORECASTING WHEN FUEL SWITCHING

This measure can involve fuel switching from fossil fuel to electric.

For the purposes of forecasting load reductions due to fuel switch projects per Section 16-111.5B, changes in site energy use at the customer’s meter (using ΔkWh algorithm below) adjusted for utility line losses (at-the-busbar savings), customer switching estimates, NTG, and any other adjustment factors deemed appropriate, should be used.

The inputs to cost effectiveness screening should reflect the actual impacts on the electric and fuel consumption at the customer meter and, for fuel switching measures, this will not match the output of the calculation/allocation methodology presented in the “Electric Energy Savings” and “Fossil Fuel Savings” sections above. Therefore, in addition to the calculation of savings claimed, the following values should be used to assess the cost effectiveness of the measure.

$$\Delta \text{Therms} = [\text{Clothes Washer with Gas DHW Consumption Replaced} + \text{Gas Dryer Consumption Replaced}] - [\text{All-in-One Clothes Washer-Dryer Consumption Added}]$$

$$= [(\text{Capacity} * \text{IQAdj} / \text{IMEFbase} * \text{Ncycles} * (\% \text{DHWbase} * \% \text{Fossil_DHW} * R_{\text{eff}})) + ((\text{Load} / \text{CEFbase}_{\text{Gas}} * \text{IQAdj}) * \text{Ncycles} * \text{Therm_convert} * \% \text{Gas}_{\text{Gas}}) + ((\text{Load} / \text{CEFeff}_{\text{Elec}} * \text{IQAdj}) * \text{Ncycles} * \text{Therm_convert} * \% \text{Gas}_{\text{Gas}}))] - [(\text{Capacity} * 1 / \text{IMEFeff} * \text{Ncycles} * (\% \text{CWeff} + (\% \text{DHWeff} * \% \text{Electric_DHW})) * \text{Therm_convert}) + (\text{Load} / \text{CEFeff} * \text{Ncycles} * \% \text{Gas}_{\text{gas}} * \text{Therm_convert})]$$

$$\Delta kWh = [\text{Clothes Washer with Gas DHW Electric Consumption Replaced} + \text{Gas Dryer Electric Consumption Replaced}] - [\text{All-in-One Clothes Washer-Dryer Consumption Added}]$$

$$= [((\text{Load} / \text{CEFbase}_{\text{Gas}} * \text{IQAdj}) * \text{Ncycles} * \% \text{Electric}_{\text{Gas}}) + (\text{Capacity} * 1 / \text{IMEFbase} * \text{Ncycles} * (\% \text{CWbase} + (\% \text{DHWbase} * \% \text{Electric_DHW}_{\text{base}}))] - [((\text{Load} / \text{CEFeff} * \text{Ncycles} * \% \text{Gas}_{\text{gas}}) + (\text{Load} / \text{CEFeff} * \text{Ncycles} * \% \text{Electric}_{\text{gas}})) + (\text{Capacity} * 1 / \text{IMEFeff} * \text{Ncycles} * (\% \text{CWeff} + (\% \text{DHWeff} * \% \text{Electric_DHW}_{\text{efficient}}))]$$

MEASURE CODE: RS-APL-ACWD-V01-250101

REVIEW DEADLINE: 1/1/2028

5.2 Consumer Electronics End Use

5.2.1 Advanced Power Strip – Tier 1

DESCRIPTION

This measure relates to Advanced Power Strips – Tier 1 which are multi-plug surge protector power strips with the ability to automatically disconnect specific connected loads depending upon the power draw of a control load, also plugged into the strip. Power is disconnected from the switched (controlled) outlets when the control load power draw is reduced below a certain adjustable threshold, thus turning off the appliances plugged into the switched outlets. By disconnecting the standby load of the controlled devices, the overall load of a centralized group of equipment (i.e. entertainment centers and home office) can be reduced. Uncontrolled outlets are also provided that are not affected by the control device and so are always providing power to any device plugged into it. This measure characterization provides savings for a 5-plug strip and a 7-plug strip.

This measure was developed to be applicable to the following program types: TOS, NC, DI, KITS. If applied to other program types, the measure savings should be verified.

DEFINITION OF EFFICIENT EQUIPMENT

The efficient case is the use of a 5 or 7-plug advanced power strip.

DEFINITION OF BASELINE EQUIPMENT

For time of sale or new construction applications, the assumed baseline is a standard power strip that does not control connected loads.

For direct install and kits, the baseline is the existing equipment utilized in the home.

DEEMED LIFETIME OF EFFICIENT EQUIPMENT

The assumed lifetime of the advanced power strip is 7 years.³¹¹

DEEMED MEASURE COST

For time of sale or new construction the incremental cost of an advanced Tier 1 power strip over a standard power strip with surge protection is assumed to be \$10.³¹²

For direct install the actual full equipment and installation cost (including labor) and for kits the actual full equipment cost should be used.

Equipment cost if unknown³¹³:

Baseline Cost	Efficient Cost	Incremental Equipment Cost
\$20	\$30	\$10

LOADSHAPE

Loadshape R13 - Residential Standby Losses – Entertainment

Loadshape R14 - Residential Standby Losses - Home Office

³¹¹ This is a consistent assumption with 5.2.2 Advanced Power Strip – Tier 2.

³¹² Price survey performed by Illume Advising LLC for IL TRM workpaper, see “Current Surge Protector Costs and Comparison 7-2016” spreadsheet.

³¹³ Price survey performed by Illume Advising LLC for IL TRM workpaper, see “Current Surge Protector Costs and Comparison 7-2016” spreadsheet.

COINCIDENCE FACTOR

The summer peak coincidence factor for this measure is assumed to be 80%.³¹⁴

Algorithm

CALCULATION OF SAVINGS ELECTRIC ENERGY SAVINGS

$$\Delta\text{kWh} = \text{kWh} * \text{ISR}$$

Where:

- kWh = Assumed annual kWh savings per unit
= 56.5 kWh for 5-plug units or 103 kWh for 7-plug units³¹⁵
- ISR = In Service Rate, dependent on delivery mechanism

³¹⁴ Efficiency Vermont 2016 TRM coincidence factor for advanced power strip measure –in the absence of empirical evaluation data, this was based on assumptions of the typical run pattern for televisions and computers in homes.

³¹⁵ NYSERDA Measure Characterization for Advanced Power Strips. Study based on review of:

Smart Strip Electrical Savings and Usability, Power Smart Engineering, October 27, 2008.

Final Field Research Report, Ecos Consulting, October 31, 2006. Prepared for California Energy Commission's PIER Program.

Developing and Testing Low Power Mode Measurement Methods, Lawrence Berkeley National Laboratory (LBNL), September 2004. Prepared for California Energy Commission's Public Interest Energy Research (PIER) Program.

2005 Intrusive Residential Standby Survey Report, Energy Efficient Strategies, March 2006.

Smart Strip Portfolio of the Future, Navigant Consulting for San Diego G&E, March 31, 2009.

"Smart strip" in this context refers to the category of Advanced Power Strips, does not specifically signify Smart Strip® from BITS Limited, and was used without permission. Smart Strip® is a registered trademark of BITS Smart Strip, LLC.

An additional more recent study in Massachusetts by NMR Group, Inc., "RLPNC 17-3: Advanced Power Strip Metering Study", March 19, 2019 provides a consistent result to the final savings presented here. On p77 the average savings found was 78 kWh which includes accounting for In Service Rate, Short Term Retention Rate and Realization Rate.

Delivery Mechanism	ISR
Multifamily Energy Efficiency Kit, Leave behind	47% ³¹⁶
Single Family Energy Efficiency Kit, Leave behind	55% ³¹⁷
Income Qualified Energy Efficiency Kit, Mailed	69% ³¹⁸
Community Distributed Kit	91% ³¹⁹
Direct Install (installations should be limited to high use locations such as office or entertainment centers)	100%
Time of Sale	71% ³²⁰

Using assumptions above:

# Plugs	Delivery Mechanism	ΔkWh
5- plug	Multifamily Energy Efficiency Kit, Leave behind	22.6
	Single family Energy Efficiency Kit, Leave behind	31.1
	Income Qualified Energy Efficiency Kit, Mailed	39.0
	Community Distributed Kit	51.4
	Direct Install	56.5
	Time of Sale	40.1
7-plug	Multifamily Energy Efficiency Kit, Leave behind	41.2
	Single family Energy Efficiency Kit, Leave behind	56.7
	Income Qualified Energy Efficiency Kit, Mailed	71.1
	Community Distributed Kit	93.8
	Direct Install	103.0
	Time of Sale	73.1
Unknown ³²¹	Multifamily Energy Efficiency Kit, Leave behind	31.9

³¹⁶ Opinion Dynamics and Navigant. Impact Evaluation for ComEd 2018 site visit efforts for leave-behind measures in public housing multi-family units. The Evaluation Team completed site visits for 72 apartment units across seven of the ten participating properties in which advanced power strips were installed. The Evaluation Team attempted a census using all data provided at the time of site visit planning (Fall 2018). The program distributed a total of 476 advanced power strips, with 471 distributed amongst the seven properties with completed site visits. The Team performed intrasite sampling within each property and verified a total of 37 advanced power strips of the 92 within the sample. Opinion Dynamics conducted primary research with tenants of participating multifamily buildings in 2023 to study their usage behavior after Program Allies left advanced power strips in their units. Opinion Dynamics, “2023 AIC Multifamily Initiatives Tenant Survey Findings Memo,” Ameren Illinois, Multifamily Initiatives, April 24, 2024. 54% of survey respondents reported that the Advanced Power Strip was properly installed and in use properly. An average of these two sources results in an overall ISR of 47%.

³¹⁷ Research from 2018 ComEd Home Energy Assessment participant survey.

³¹⁸ Research from 2021 Ameren Illinois Income Qualified participant survey (customer self-report), available on IL SAG website: <https://ilsag.s3.amazonaws.com/AIC-Income-Qualified-Initiative-Participant-Survey-Results-Memo-FINAL-2022-02-01.pdf>

³¹⁹ Research from 2018 Ameren Illinois Income Qualified participant survey.

³²⁰ Research from 2019 ComEd Appliance Rebate Program- Online Marketplace participant survey

³²¹ Calculated as average of 5 and 7 plug savings assumptions.

# Plugs	Delivery Mechanism	ΔkWh
	Single family Energy Efficiency Kit, Leave behind	43.9
	Income Qualified Energy Efficiency Kit, Mailed	55.0
	Community Distributed Kit	72.6
	Direct Install	80.0
	Time of Sale	56.6

SUMMER COINCIDENT PEAK DEMAND SAVINGS

$$\Delta kW = \Delta kWh / \text{Hours} * CF$$

Where:

Hours = Annual number of hours during which the controlled standby loads are turned off by the Tier 1 Advanced power Strip.

$$= 7,129^{322}$$

CF = Summer Peak Coincidence Factor for measure

$$= 0.8^{323}$$

# Plugs	Delivery Mechanism	ΔkW
5- plug	Multifamily Energy Efficiency Kit, Leave behind	0.0025
	Single family Energy Efficiency Kit, Leave behind	0.0035
	Income Qualified Energy Efficiency Kit, Mailed	0.0044
	Community Distributed Kit	0.0058
	Direct Install	0.0063
	Time of Sale	0.0045
7-plug	Multifamily Energy Efficiency Kit, Leave behind	0.0046
	Single family Energy Efficiency Kit, Leave behind	0.0064
	Income Qualified Energy Efficiency Kit, Mailed	0.0080
	Community Distributed Kit	0.0105
	Direct Install	0.0116
	Time of Sale	0.0082
Unknown ³²⁴	Multifamily Energy Efficiency Kit, Leave behind	0.0036
	Single family Energy Efficiency Kit, Leave behind	0.0049
	Income Qualified Energy Efficiency	0.0062

³²² Average of hours for controlled TV and computer from; NYSERDA Measure Characterization for Advanced Power Strips

³²³ Efficiency Vermont 2016 TRM coincidence factor for advanced power strip measure –in the absence of empirical evaluation data, this was based on assumptions of the typical run pattern for televisions and computers in homes.

³²⁴ Calculated as average of 5 and 7 plug savings assumptions.

# Plugs	Delivery Mechanism	ΔkW
	Kit, Mailed	
	Community Distributed Kit	0.0081
	Direct Install	0.0090
	Time of Sale	0.0064

FOSSIL FUEL SAVINGS

N/A

WATER IMPACT DESCRIPTIONS AND CALCULATION

N/A

DEEMED O&M COST ADJUSTMENT CALCULATION

N/A

MEASURE CODE: RS-CEL-SSTR-V10-250101

REVIEW DEADLINE: 1/1/2029

5.2.2 Tier 2 Advanced Power Strips (APS) – Residential Audio Visual

DESCRIPTION

This measure relates to the installation of a Tier 2 Advanced Power Strip / surge protector for household audio visual environments (Tier 2 AV APS). Tier 2 AV APS are multi-plug power strips that remove power from audio visual equipment through intelligent control and monitoring strategies.

By utilizing advanced control strategies such as a countdown timer, external sensors (e.g. of infra-red remote usage and/or occupancy sensors, true RMS (Root Mean Square) power sensing; both active power loads and standby power loads of controlled devices are managed by Tier 2 AV APS devices.³²⁵ Monitoring and controlling both active and standby power loads of controlled devices will reduce the overall load of a centralized group of electrical equipment (i.e. the home entertainment center). This more intelligent sensing and control process has been demonstrated to deliver increased energy savings and demand reduction compared with ‘Tier 1 Advanced Power Strips’.

This measure was developed to be applicable to the following program types: DI. If applied to other program delivery types, the installation characteristics including the number of AV devices under control and an appropriate in service rate should be verified through evaluation.

Current evaluation is limited to Direct Install applications. Through a Direct Install program it can be assured that the APS is appropriately set up and the customer is knowledgeable about its function and benefit. It is encouraged that additional implementation strategies are evaluated to provide an indication of whether the units are appropriately set up, used with AV equipment and that the customer is knowledgeable about its function and benefit. This will then facilitate a basis for broadening out the deployment methods of the APS technology category beyond Direct Install.

DEFINITION OF EFFICIENT EQUIPMENT

The efficient case is the use of a Tier 2 AV APS in a residential AV (home entertainment) environment that includes control of at least 2 AV devices with one being the television.³²⁶

The minimum product specifications for Tier 2 AV APS are:

Safety & longevity

- Product and installation instructions shall comply with 2012 International Fire Code and 2000 NFPA 101 Life Safety Code (IL Fire Code).
- Third party tested to all applicable UL Standards.
- Contains a resettable circuit breaker
- Incorporates power switching electromechanical relays rated for 100,000 switching cycles at full 15 amp load (equivalent to more than 10 years of use).

Energy efficiency functionality

- Calculates real power as the time average of the instantaneous power, where instantaneous power is the product of instantaneous voltage and current.
- Delivers a warning when the countdown timer begins before an active power down event and maintains the warning until countdown is concluded or reset by use of the remote or other specified signal
- Uses an automatically adjustable power switching threshold.

³²⁵ Tier 2 AV APS identify when people are not engaged with their AV equipment and then remove power, for example a TV and its peripheral devices that are unintentionally left on when a person leaves the house or for instance where someone falls asleep while watching television.

³²⁶ Given this requirement, an AV environment consisting of a television and DVD player or a TV and home theater would be eligible for a Tier 2 AV APS installation.

DEFINITION OF BASELINE EQUIPMENT

The assumed baseline equipment is the existing equipment being used in the home (e.g. a standard power strip or wall socket) that does not control loads of connected AV equipment.

DEEMED LIFETIME OF EFFICIENT EQUIPMENT

The default deemed lifetime value for Tier 2 AV APS is assumed to be 7 years.³²⁷

DEEMED MEASURE COST

Direct Installation: The actual installed cost (including labor) of the new Tier 2 AV APS equipment should be used.

Baseline equipment cost if unknown is assumed to be \$20³²⁸.

LOADSHAPE

Loadshape R13 - Residential Standby Losses – Entertainment

COINCIDENCE FACTOR

The summer peak coincidence factor for this measure is assumed to be 80%.³²⁹

³²⁷ There is little evaluation to base a lifetime estimate upon. Based on review of assumptions from other jurisdictions and the relative treatment of In Service Rates and persistence, an estimate of 7 years was agreed by the Technical Advisory Committee, but further evaluation is recommended.

³²⁸ Price survey performed by Illume Advising LLC for IL TRM workpaper, see “Current Surge Protector Costs and Comparison 7-2016” spreadsheet.

³²⁹ In the absence of empirical evaluation data, this was based on assumptions of the typical run pattern for televisions and computers in homes.

Algorithm

CALCULATION OF ENERGY SAVINGS

ELECTRIC ENERGY SAVINGS

$$\Delta kWh = ERP * BaselineEnergy_{AV} * ISR$$

Where:

ERP = Energy Reduction Percentage of qualifying Tier2 AV APS product range as provided below. Savings are based upon independent field trials of two product manufacturers and the savings differences are assumed to relate to the product classifications provided below. Additional evaluation will be reviewed in future cycles to confirm if additional classification categories are appropriate.

Product Type	ERP used
Infrared Only	40% ³³⁰
Infrared and Occupancy Sensor	25% ³³¹

$$BaselineEnergy_{AV} = 466 \text{ kWh}^{332}$$

ISR = In Service Rate.

Product Type	ISR ³³³
Infrared Only	73%
Infrared and Occupancy Sensor	83%

Deemed savings for each product type are provided below:

³³⁰ Representative savings assumption based on the following independent field tests on Embertec’s IR-only product. This includes both simulated saving results (based on recording what action the APS would have taken, but where equipment is not actually switched off allowing evaluation of the expected length of savings), and pre/post metering studies.

- AESC (page 30) - Valmiki, MM., Corradini, Antonio PE. 2015. *Tier 2 Advanced Power Strips in Residential and Commercial Applications*. Prepared for San Diego Gas & Electric by Alternative Energy Systems Consulting, Inc. (Simulated 50%, pre/post 32%).
- AESC- Valmiki, MM., Corradini, Antonio PE., Feb 2016. *Energy Savings of Tier 2 Advanced Power Strips in Residential AV Systems*. (Simulated 50%, pre/post 29%)
- CalPlug research (Page 12) - Wang, M. e. 2014. “*Tier 2 Advanced Power Strip Evaluation for Energy Saving Incentive*”. California Plug Load Research Center (CalPlug), UC Irvine. (Simulated 51%)
- NMR Group Inc., *RLPNC 17-3: Advanced Power Strip Metering Study*, Revised March 18, 2019, submitted to Massachusetts Program Administrators and EEAC. (Pre/post with regression 50%, Pre/post only 20%).

³³¹ Representative savings assumption based on the following independent field tests on TrickeStar IR-OS product and reflect both simulated and pre/post meter study results.

- AESC- Valmiki, MM., Corradini, Antonio PE., Feb 2016. *Energy Savings of Tier 2 Advanced Power Strips in Residential AV Systems*. (Simulated 27%, pre/post 25%)
- NMR Group Inc., *RLPNC 17-3: Advanced Power Strip Metering Study*, Revised March 18, 2019, submitted to Massachusetts Program Administrators and EEAC. (Pre/post with regression 37%, Pre/post only 11%)

³³² Average of baseline energy in Regional Technical Form survey of Tier 2 APS pre-post methodology studies, see ‘RTF_T2_APS.ppt’.

³³³ Weighted average of evaluation results from AESC, Inc, “Energy Savings of Tier 2 Advanced Power Strips in Residential AC Systems”, p35. These assumptions include “adjustments in weighting based on the persistence sensitivity to demographics” and NMR Group Inc., *RLPNC 17-3: Advanced Power Strip Metering Study*, Revised March 18, 2019.

Product Type	ΔkWh
Infrared Only	136.1
Infrared and Occupancy Sensor	96.7

SUMMER COINCIDENT PEAK DEMAND SAVINGS

$$\Delta kW = \Delta kWh / \text{Hours} * CF$$

Where:

ΔkWh = Energy savings as calculated above

Hours = Annual number of hours during which the APS provides savings.
= 4,380³³⁴

CF = Summer Peak Coincidence Factor for measure
= 0.8³³⁵

Deemed savings for each product type are provided below:

Product Type	ΔkW
Infrared Only	0.0249
Infrared and Occupancy Sensor	0.0177

FOSSIL FUEL SAVINGS

N/A³³⁶

WATER AND OTHER NON-ENERGY IMPACT DESCRIPTIONS AND CALCULATION

N/A

DEEMED O&M COST ADJUSTMENT CALCULATION

N/A

MEASURE CODE: RS-CEL-APS2-V06-240101

REVIEW DEADLINE: 1/1/2029

³³⁴ This is estimate based on assumption that approximately half of savings are during active hours (supported by AESC study) (assumed to be 5.3 hrs/day, 1936 per year (NYSERDA 2011. “Advanced Power Strip Research Report”)) and half during standby hours (8760-1936 = 6824 hours). The weighted average is 4380.

³³⁵ In the absence of empirical evaluation data, this was based on assumptions of the typical run pattern for televisions and computers in homes. This appears to be supported by the Average Weekday AV Demand Profile and Reduction charts in the AESC study (p33-34). These show that the average demand reduction is relatively flat.

³³⁶ Interactive effects of Tier 2 APS on space conditioning loads has not yet been adequately studied.

5.2.3 ENERGY STAR Television

DESCRIPTION

An ENERGY STAR Certified television installed in place of a standard television.

This measure was developed to be applicable to the following program types: [TOS]. If applied to other program types, the measure savings should be verified.

DEFINITION OF EFFICIENT EQUIPMENT

The efficient equipment is defined as a television meeting the ENERGY STAR Version 9.0.

DEFINITION OF BASELINE EQUIPMENT

The baseline equipment is defined as a non ENERGY STAR certified television.

DEEMED LIFETIME OF EFFICIENT EQUIPMENT

The assumed lifetime of this measure is 5 years.³³⁷

DEEMED MEASURE COST

The incremental cost for this measure is \$60.³³⁸

LOADSHAPE

R13: Residential Standby Losses - Entertainment

COINCIDENCE FACTOR

The coincidence factor for this measure is assumed to be 22%.³³⁹

Algorithm

CALCULATION OF ENERGY SAVINGS

ELECTRIC ENERGY SAVINGS

ENERGY STAR savings summarized in table below:³⁴⁰

Equipment Size Bin	ΔkWh
≤47.5"	93.2
47.5" < x ≤ 52.5"	91.3
52.5" < x ≤ 59.5"	71.6
59.5" < x ≤ 69.5"	75.3
69.5" < x ≤ 80"	31.7

³³⁷ 'ENERGY STAR Version 9.0 TVs Data Package.xls'.

³³⁸ Estimate from 'Savings Estimation Technical Reference Manual, 2017'. Highest cost estimate due to majority of TVs now being the larger bin sizes. This estimate is an old reference and would benefit a new study to improve the assumption.

³³⁹ Based upon Hawai'i Energy, Technical Reference Manual, 2018

³⁴⁰ 'ENERGY STAR Version 9.0 TVs Data Package.xls'.

SUMMER COINCIDENT PEAK DEMAND SAVINGS

$$\Delta kW = \Delta kWh / \text{Hours} * CF$$

Where:

Hours = Estimate of hours savings achieved.

$$= 1759^{341}$$

CF = Coincidence Factor

$$= 0.22^2$$

Equipment Size Bin	ΔkW
$\leq 47.5''$	0.01166
$47.5'' < x \leq 52.5''$	0.01142
$52.5'' < x \leq 59.5''$	0.00896
$59.5'' < x \leq 69.5''$	0.00942
$69.5'' < x \leq 80''$	0.00396

FOSSIL FUEL SAVINGS

n/a

WATER AND OTHER NON-ENERGY IMPACT DESCRIPTIONS AND CALCULATION

n/a

DEEMED O&M COST ADJUSTMENT CALCULATION

n/a

MEASURE CODE: RS-CEL-TVS-V02-250101

REVIEW DEADLINE: 1/1/2028

³⁴¹ Most savings are achieved during “automatic brightness control” during active viewing. Recent study Nielsen “State of Play” found average viewing of 4.82 hours per day = 1759 hours per year.

5.2.4 Smart Sockets

DESCRIPTION

Smart sockets achieve savings through the reduction of the standby load of the controlled appliance, as well as eliminating the operation of an appliance during unoccupied hours. The standby power consumption of home appliances can be significantly reduced.

Smart Sockets in homes can be used for all types of appliances and significant saving opportunities exist for devices which are rarely unplugged like televisions, lamps, and speakers. The savings are derived from the times when the devices are not in use. Devices plugged in, even when off, consume electricity and smart sockets will reduce this standby load. In addition, smart sockets can be used to schedule equipment, so the load is less during hours which the devices are not in use.

This measure was developed to be applicable to the following program types: DI, KITS

DEFINITION OF EFFICIENT EQUIPMENT

The efficient case is the use of a smart plug with a standby power wattage of 2W or less. Should be UL listed. (Simply Conserve Smart Socket SS-15A1-WiFi has a standby power of less than or equal to 0.7).

DEFINITION OF BASELINE EQUIPMENT

The assumed baseline is an appliance plugged into an outlet or into a standard power strip with surge protection that does not control connected loads. Note many ENERGY STAR appliances require power saving settings which will partially offset the savings potential of this measure. Where possible non-ENERGY STAR equipment should be plugged in to the socket to ensure savings are realized.

DEEMED LIFETIME OF EFFICIENT EQUIPMENT

The assumed lifetime of the smart socket is 7 years.

DEEMED MEASURE COST

For direct install, the actual full equipment and installation cost (including labor) and for kits the actual full equipment cost should be used. If unknown for kits, use \$9.00/each³⁴².

LOADSHAPE

Loadshape R13 – Standby Losses – Entertainment Center

COINCIDENCE FACTOR

The summer peak coincidence factor for this measure is assumed to be 80%.³⁴³

³⁴² Based on cost from vendor of typical smart socket on the market, Simply Conserve Smart Socket by AM Conservation Group. 10 amp smart socket: \$8.92/each; 15 amp smart socket: \$9.00/each.

³⁴³ Efficiency Vermont 2016 TRM coincidence factor for advanced power strip measure –in the absence of empirical evaluation data, this was based on assumptions of the typical run pattern for televisions and computers in homes.

Algorithm

CALCULATION OF ENERGY SAVINGS

ELECTRIC ENERGY SAVINGS

$$\Delta kWh = ((W_{Base} * OnAdj) - W_{Eff}) * Hours / 1000 * ISR$$

Where:

W_{Base}^{344} = Standby power or On power consumption of connected appliance.

Use actual if known, or refer to tables below. If unknown, e.g. via kits, assume 9.4W

Appliances assumed to be in standby mode:

Controlled Equipment ³⁴⁵	Standby Power (W)
Coffee Maker	1.14
Television, CRT	3.06
Television, Rear Projection	6.97
Television, LCD ³⁴⁶	8.00
Set-top Box, DVR	36.68
Set-top Box, Digital Cable	17.83
Set-top Box, Satellite	15.66
Television/VCR	5.99
VCR	4.68
Computer, Desktop	2.84
Computer Notebook	8.90
Multifunction Device, Inkjet	5.26
Multifunction Device, Laser	3.12
Scanner, Flatbed	2.48

Appliances assumed to be in on mode:

Controlled Equipment ³⁴⁷	On Power (W)
Light	10.4
Fan	70
Space Heater	450

$OnAdj^{348}$ = Adjustment for wattages of appliances that are powered on during unoccupied hours

³⁴⁴ Average connected wattage found in Guidehouse, 'ComEd Small Business Kits CY2020 Impact Evaluation Report 2021-04-01 Final.pdf'.

³⁴⁵ See Standby Power Summary Table contained in "Standby Power", Lawrence Berkeley National Laboratory, Building Technology and Urban Systems Division, <https://standby.lbl.gov/data/summary-table/>

³⁴⁶ From "iTECH evaluation on the SmartSocket," ITECH Electronic Co., LTD, 1/28/19. IoT – Related Technical Articles. <https://www.itechate.com/uploadfiles/2019/01/201901281143214321.pdf>.

³⁴⁷ See Standby Power Summary Table contained in "Standby Power", Lawrence Berkeley National Laboratory, Building Technology and Urban Systems Division, <https://standby.lbl.gov/data/summary-table/>

³⁴⁸ "4.8.22 Smart Sockets," in Illinois Statewide Technical Reference Manual – Volume 2: Commercial and Industrial Measures, v.11.0, 2023

- = 50% for appliances in on mode
- =100% for appliances in standby mode and for unknown
- W_{Eff} = Standby power consumption of smart socket. If unknown, assume 0.7W.
- Hours = Unused hours per year. If unknown, use 5,794.2 Hours/year

Assumptions	Weekly Hours	Annual Hours
Total Hours per week	168	8,769.6
Hours at work	40	2,088
Hours commuting	5	261
Errands/Social/etc.	10	522
Sleep	56	2,923.2
Hours appliances are unused	111	5,794.2

- ISR = In Service Rate, dependent on delivery mechanism³⁴⁹

Delivery Mechanism	ISR
Direct Install	97.3%
Single Family Energy Efficiency Kit, Leave behind	74%
Income Qualified Energy Efficiency Kit, Mailed	82%
Community Distributed Kit	93%
Multifamily Energy Efficiency Kit, Leave behind	40%
Virtual Single Family	85.6%
Virtual Multi Family	68.6%

SUMMER COINCIDENT PEAK DEMAND SAVINGS

$$\Delta kW = \Delta kWh / \text{Hours} * CF$$

Where:

- CF = Summer Peak Coincidence Factor for measure
- = 0.8³⁵⁰

FOSSIL FUEL SAVINGS

N/A

WATER AND OTHER NON-ENERGY IMPACT DESCRIPTIONS AND CALCULATION

N/A

DEEMED O&M COST ADJUSTMENT CALCULATION

N/A

³⁴⁹ Using averages of Advanced Power Strip – Tier 1 and Connected LED Lamps from Volume 3 Residential Measures V11.0. See ‘Smart Sockets Working ISRs’ workbook for additional details.

³⁵⁰ Efficiency Vermont 2016 TRM coincidence factor for advanced power strip measure –in the absence of empirical evaluation data, this was based on assumptions of the typical run pattern for televisions and computers in homes.

MEASURE CODE: RS-CEL-SSOC-V01-240101

REVIEW DEADLINE: 1/1/2026

5.3 HVAC End Use

5.3.1 Air Source Heat Pumps (Centrally Ducted, Ductless and Portable)

DESCRIPTION

A heat pump provides heating or cooling by moving heat between indoor and outdoor air. This measure relates to:

- a unitary central heat pump (split or packaged) with conditioned air delivered to the home via ductwork
- a ductless minisplit system
- “hybrid” systems that work in conjunction with fuel-fired heating systems, and
- a portable heat pump (mounted within a wall, within a window, or floor-mounted with intake and/or exhaust duct(s) directed through a window).

This measure characterizes:

a) New Construction:

- The installation of a new residential sized ($\leq 65,000$ Btu/hr) Air Source Heat Pump meeting minimum requirements determined by the program in a new home.
- Note the baseline in this case should be determined via EM&V and the algorithms are provided to allow savings to be calculated from any baseline condition.

b) Time of Sale:

- The installation of a new residential sized ($\leq 65,000$ Btu/hr) Air Source Heat Pump meeting minimum requirements determined by the program. This relates to the replacement of an existing unit at the end of its useful life.
- Note the baseline in this case is an equivalent replacement system to that which exists currently in the home. Where unknown, the baseline should be determined via EM&V and the algorithms are provided to allow savings to be calculated from any baseline condition.
- The allocation of savings is dependent on whether an incentive for the installation has been provided by both a gas and electric utility, just an electric utility or just a gas utility.

c) Early Replacement:

The early removal of functioning components of the electric or gas heating and/or cooling systems from service, prior to its natural end of life, and replacement with a new high efficiency air source heat pump unit.

Note the baseline in this case is the existing equipment being replaced. The allocation of savings is dependent on whether an incentive for the installation has been provided by both a gas and electric utility, just an electric utility or just a gas utility.

Early Replacement determination will be based on meeting the following conditions:

- The existing unit is operational when replaced, or
- The existing unit requires minor repairs ($< \$276$ per ton).³⁵¹
- All other conditions will be considered Time of Sale.

The Baseline SEER2 of the existing unit replaced:

- Is the actual SEER (converted to SEER2) value of the unit replaced.
- If the SEER of the existing unit is unknown use assumptions in variable list below (SEER2_exist and HSPF2_exist).

³⁵¹ The Technical Advisory Committee agreed that if the cost of repair is less than 20% of the new baseline replacement cost it can be considered early replacement. Note the non-inflated cost is used as this would be a cost consideration in the program year.

- If the operational status or repair cost of the existing unit is unknown, use time of sale assumptions or average weighted factors determined via evaluation and the algorithms below.

A weighted average early replacement rate is provided for use in programs when the actual baseline early replacement rates are unknown.

Deemed Early Replacement Rates For ASHP³⁵²

Equipment Type	Full System Displacement	Partial System Displacement
Cooling	30%	30%
Heating	30%	100%

Note to apply these deemed early replacement rates, an assumption of the percentage of replacements that are full displacement v partial displacement is required. This should be determined through evaluation, or a deemed ratio of 100% Full Displacement for ducted ASHPs and 50% Full: 50% Partial for Ductless ASHPs can be used³⁵³. Savings should be calculated following both the full and partial displacement methodology and then this ratio should be used to weight the savings accordingly.

Quality Installation:

Additional savings are attributed to the Quality Installation (QI) of the system. QI programs should follow industry standards such as those described in ENERGY STAR Verified HVAC Installation Program (ESVI), ANSI ACCA QI5 and QI9vp. This must include considerations of system design (including sizing, matching, ventilation calculations) and equipment installation (including static pressure, airflow, refrigerant charge) and may also consider distribution.

This measure was developed to be applicable to the following program types: TOS, NC, EREP. If applied to other program types, the measure savings should be verified.

DEFINITION OF EFFICIENT EQUIPMENT

A new residential sized (<= 65,000 Btu/hr) air source heat pump with specifications to be determined by program.

The following conversion factors are recommended for use if the efficient equipment is not rated under the new testing procedure:³⁵⁴

$$\begin{aligned} \text{SEER2} &= \text{SEER} * X \\ \text{EER2} &= \text{EER} * X \\ \text{HSPF2} &= \text{HSPF} * X \end{aligned}$$

Where:

³⁵² Program tracking data from ComEd and Ameren between 2018 and 2020 was used to develop these assumptions. During this period the air source heat pump programs operated downstream and projects were classified as Time of Sale or Early Replacement. Note that any fuel switch scenario at the time would have been classified as Time of Sale and therefore the rates provided likely represent a low estimate of the true early replacement rates. In the absence of alternative data, the TAC agreed to apply these rates and the deemed full v partial displacement assumptions listed, but these assumptions should be revisited through future evaluation.

³⁵³ For ductless ASHPs with a capacity less than 18kBtu, the Full Displacement calculation should use the lower ‘Supplemental’ EFLHs provided, and the Partial Displacement calculation use the Standard hours. All other calculations should use the Standard hours. We assume that smaller systems are typically used to (1) provide all of the heating/cooling for zones outside of central living zones or (2) as partial displacement of existing systems in central living zones.

³⁵⁴ Consortium for Energy Efficiency (CEE), Testing, Testing, M1, 2, 3, Transitioning to New Federal Minimum Standards, CEE Summer Program Meeting, August, 2022.

X	SEER	EER	HSPF
Ducted	0.95	0.95	0.85
Non-Ducted	1.00	1.00	0.90
Packaged/Portable	0.95	0.95	0.84

DEFINITION OF BASELINE EQUIPMENT

The baseline designation can be assigned differently for heating and cooling for the same installation, but the designation must remain consistent when applying the TRM calculations (e.g., for energy savings, measure cost, and demand savings). For example, customers may choose to replace an AC at the end of its useful life yet continue using their existing furnace. In this case, the cooling replacement could represent a time of sale baseline while the heating replacement could reflect an early replacement baseline.

New Construction: To calculate savings with an electric baseline, the baseline equipment is assumed to be an Air Source Heat Pump meeting the Federal Standard efficiency level:³⁵⁵

- Split system ducted heat pump standard sized units – 14.3 SEER2, 7.5 HSPF2, 9.4 EER2
- Split system ductless heat pump standard sized units – 14.3 SEER2, 7.5 HSPF2, 8.5 EER2
- Space constrained heat pump units – 11.9 SEER2, 7.8 EER2 and 6.3 HSPF2

Note, the space constrained product baseline should only be used when the efficient unit is classified as space constrained (labelled as SCP on AHRI database).

To calculate savings with a furnace/central AC baseline, the baseline equipment is assumed to be an 80% AFUE Furnace and central AC meeting the Federal Standard efficiency level; 13.4 SEER2, 10.6 EER2 for standard sized units, or 11.7SEER, 9.2 EER2 for space constrained product.

Time of Sale: The baseline for this measure is a new replacement unit of the same system type as the existing unit, meeting the baselines provided below³⁵⁶.

Unit Type	Efficiency Standard
Standard sized Ducted ASHP	14.3 SEER2, 9.4 EER2, 7.5 HSPF2
Standard sized Ductless ASHP	14.3 SEER2, 8.5 EER2, 7.5 HSPF2
Space constrained ASHP	11.9 SEER2, 7.8 EER2, 6.3 HSPF2
Room AC (baseline for portable HP only)	Select appropriate baseline from measure 5.1.7. Assume same capacity as efficient.
Electric Resistance (default for portable HP)	3.412 HSPF2
Natural Gas or LP Furnace	80% AFUE
Natural Gas or LP Boiler	84% AFUE
Oil Furnace	83% AFUE
Oil Boiler	86% AFUE
Standard sized Central AC	13.4 SEER2, 10.6 EER2
Space constrained Central AC	11.7 SEER2, 9.2 EER2

³⁵⁵ The federal Standard does not currently include an EER2 component for northern states. The value provided is based on scaling CEE Tier 1 ratings for North and Canada (12EER2 for CAC, 10EER2 for ducted HP and 9.0EER2 for ductless HP) proportionally down compared to the Federal baseline SEER2 compared to CEE Tier 1 SEER2 ratings.

³⁵⁶ Federal Standard as provided in DOE 10 CFR 430.32.

Unit Type	Efficiency Standard
Unknown, installing ducted ³⁵⁷	13.9 SEER2, 9.4 EER2, 5.9HSPF2, 80.1% AFUE
Unknown, installing ductless	13.7 SEER2, 8.5 EER2, 5.3HSPF2, 81.1% AFUE

Early replacement / Retrofit: The baseline for this measure is the efficiency of the *existing* heating and cooling equipment for the assumed remaining useful life of the existing unit and a new baseline heating and cooling system for the remainder of the measure life (as provided in table above).

When unknown, default early replacement efficiency assumptions are 9.2 SEER2, 7.4 EER2, 4.5 HSPF2 and 80% AFUE when installing ducted ASHP and 9.5 SEER2, 7.4 EER2, 4.4 HSPF2 and 63% AFUE when installing ductless³⁵⁸. Consistent with TRM Volume 1 Section 2.3.1 for midstream programs or other cases where the existing condition is unknown, it may be appropriate to apply a deemed percent split of Time of Sale and Early Replacement assumptions based on evaluation results.

DEEMED LIFETIME OF EFFICIENT EQUIPMENT

The expected measure life is assumed to be 16 years for ducted and ductless ASHP³⁵⁹ and 12 years for portable HP³⁶⁰.

Remaining life of existing equipment is assumed to be 6 years for ASHP and Central AC, 7 years for furnace, 8 years for boilers³⁶¹ and 16 years for electric resistance.³⁶²

DEEMED MEASURE COST

Centrally Ducted Air Source Heat Pumps:

New Construction and Time of Sale: The actual installed cost of the Air Source Heat Pump (including any necessary electrical or distribution upgrades required) should be used minus the assumed installation cost of the baseline equipment (\$6865 + \$600 per ton for a new baseline ASHP³⁶³, \$2,011 for a new baseline 80% AFUE furnace or \$4,053 for a new 84% AFUE boiler³⁶⁴ and \$952 per ton for new baseline Central AC replacement³⁶⁵).

Early Replacement: The actual full installation cost of the Air Source Heat Pump (including any necessary electrical or distribution upgrades required) should be used. The assumed deferred cost (after the appropriate number of years described above in the ‘Deemed Lifetime of Efficient Equipment’ section) of replacing existing equipment with

³⁵⁷ Unknown time of sale baseline values represent the weighted average baseline values (in SEER2/HSPF2/AFUE) reflecting the assumed shares of installed ASHP replacing given baseline technologies (e.g. ASHP/electric resistance or furnace/boiler) by fuel type. Assumed shares are based on Opinion Dynamics and Guidehouse analysis of 2018-2021 Ameren and ComEd HVAC (downstream) program tracking data, converted to SEER2/EER2/HSPF2 using conversion factors provided. For further details, see ‘2018-2021 AIC Res HVAC Data ASHP Baseline TRM Update 2023-6-20.xls’.

³⁵⁸ Unknown early replacement baseline values represent the weighted average existing system efficiency values (converted to SEER2/HSPF2 using conversion factors provided) reflecting the assumed shares of installed ASHP replacing given baseline technologies (e.g. ASHP/electric resistance or furnace/boiler) by fuel type. Assumed shares are based on Opinion Dynamics and Guidehouse analysis of 2018-2021 Ameren and ComEd HVAC (downstream) program tracking data. For further details, see ‘2018-2021 AIC Res HVAC Data ASHP Baseline TRM Update 2023-6-20.xls’.

³⁵⁹ Based on 2016 DOE Rulemaking Technical Support document, as recommended in Guidehouse ‘ComEd Effective Useful Life Research Report’, May 2018.

³⁶⁰ Assumed the same as 5.1.7 Window Air Conditioners: Measure Life Report, Residential and Commercial/Industrial Lighting and HVAC Measures, GDS Associates, June 2007.

³⁶¹ Assumed to be one third of effective useful life of replaced equipment.

³⁶² Assume full measure life (16 years) for replacing electric resistance as we would not expect that resistance heat would fail during the lifetime of the efficient measure.

³⁶³ Full install ASHP costs are based upon data provided by Ameren. See ‘ASHP Costs_06242022’. Efficiency cost increment consistent with Cadmus “HVAC Program: Incremental Cost Analysis Update”, December 19, 2016 study results.

³⁶⁴ Furnace and boiler costs are based on data provided in Appendix E of the Appliance Standards Technical Support Documents including equipment cost and installation labor.

³⁶⁵ Based on 3 ton initial cost estimate for a conventional unit from ENERGY STAR Central AC calculator.

a new baseline unit is assumed to be \$7,722 + \$674 per ton for a new baseline Air Source Heat Pump, or \$2,296 for a new baseline 80% AFUE furnace or \$4,627 for a new 84% AFUE boiler and \$1,092 per ton for new baseline Central AC replacement.³⁶⁶ This future cost should be discounted to present value using the nominal societal discount rate.

If the install cost of the efficient Air Source Heat Pump is unknown, assume the following (note these costs are per ton of unit capacity);³⁶⁷

Efficiency (SEER2)	Full Efficient ASHP Cost (including labor)
15.2	\$7,000 + \$600/ ton
16.2	\$7,286 + \$600/ ton
17.1	\$7,495 + \$600/ ton
18.1	\$7,720 + \$600/ ton
19.0	\$7,946 + \$600/ ton

Ductless Minisplit Heat Pumps:

New Construction and Time of Sale: The actual installed cost of the DMSHP (including any necessary electrical or distribution upgrades required) should be used (defaults are provided below), minus the assumed installation cost of the baseline equipment (\$6865 + \$600 per ton for ASHP,³⁶⁸ or \$2,011 for a new baseline 80% AFUE furnace, or \$4,053 for a new 84% AFUE boiler,³⁶⁹ and \$952 per ton for new baseline Central AC replacement³⁷⁰).

Default full cost of the DMSHP is provided below. Note, for smaller units a minimum cost of \$2,000 should be applied;³⁷¹

Unit HSPF2	Full Install Cost (\$/ton) ³⁷²
8.1-8.9	\$1,443
9-9.8	\$1,605
9.9-11.6	\$1,715
11.7+	\$2,041

The incremental cost of the DSMHP compared to a baseline minimum efficiency DSMHP is provided in the table below;³⁷³

Efficiency (HSPF2)	Incremental Cost (\$/ton) over an HSPF2 7.5 DHP
8.1-8.9	\$62
9-9.8	\$224
9.9-11.6	\$334
11.7+	\$660

³⁶⁶ All baseline replacement costs are consistent with their respective measures and include inflation rate of 1.98%.

³⁶⁷ Full install ASHP costs are based upon data provided by Ameren. See 'ASHP Costs_06242022'. Efficiency cost increment consistent with Cadmus "HVAC Program: Incremental Cost Analysis Update", December 19, 2016 study results.

³⁶⁸ Full install ASHP costs are based upon data provided by Ameren. See 'ASHP Costs_06242022'.

³⁶⁹ Furnace and boiler costs are based on data provided in Appendix E of the Appliance Standards Technical Support Documents including equipment cost and installation labor. Where efficiency ratings are not provided, the values are interpolated from those that are.

³⁷⁰ Based on 3 ton initial cost estimate for a conventional unit from ENERGY STAR Central AC calculator

³⁷¹ The cost per ton table provides reasonable estimates for installation costs of DMSHP, which can vary significantly due to requirements of the home. It is estimated that all units, even units 1 ton or less will be at least \$2000 to install.

³⁷² Full costs based upon full install cost of an ASHP plus incremental costs provided in Memo from Opinion Dynamics Evaluation Team, Ductless Mini-Split Heat Pumps: Incremental Cost Analysis, April 27, 2017.

³⁷³ Memo from Opinion Dynamics Evaluation Team, Ductless Mini-Split Heat Pumps: Incremental Cost Analysis, April 27, 2017

Early Replacement/retrofit (replacing existing equipment): The actual full installation cost of the DMSHP (including any necessary electrical or distribution upgrades required) should be used. The assumed deferred cost (after 8 years) of replacing existing equipment with a new baseline unit is assumed to be \$7,722 + \$674 per ton for a new baseline Air Source Heat Pump, or \$2,296 for a new baseline 80% AFUE furnace or \$4,627 for a new 84% AFUE boiler and \$1,047 per ton for new baseline Central AC replacement.³⁷⁴ If replacing electric resistance heat, there is no deferred replacement cost. This future cost should be discounted to present value using the nominal societal discount rate.

Where the DMSHP is a supplemental HVAC system, the full installation cost of the DMSHP (including any necessary electrical or distribution upgrades required) should be used without a deferred replacement cost.

Portable Heat Pumps:

The actual installed cost of the portable heat pump (including any necessary electrical or distribution upgrades required) should be used, minus the assumed installation cost of the baseline cooling and heating system. If portable heat pump cost is unknown assume \$645 per unit.³⁷⁵ The cost of a baseline replacement room AC unit is \$408.³⁷⁶

Fuel switch scenarios are likely to require additional installation work which may include adding new electrical circuits, capping existing gas lines and upgrading electrical panels. These costs are likely to range significantly and actual values should be used wherever possible. If unknown, assume an additional \$2,000 for full displacement fuel switch installations and \$300 for partial displacement installations.

Quality Installation: The additional design and installation work associated with quality installation has been estimated to cost an additional \$150.³⁷⁷

LOADSHAPE

Loadshape R10 - Residential Electric Heating and Cooling

COINCIDENCE FACTOR

The summer peak coincidence factor for cooling is provided in two different ways below. The first is used to estimate peak savings during the utility peak hour and is most indicative of actual peak benefits, and the second represents the *average* savings over the defined summer peak period and is presented so that savings can be bid into PJM's Forward Capacity Market.

CF _{SSP SF}	= Summer System Peak Coincidence Factor for Heat Pumps in single-family homes (during utility peak hour) = 72% ³⁷⁸
CF _{PJM SF}	= PJM Summer Peak Coincidence Factor for Heat Pumps in single-family homes (average during PJM peak period) = 46.6% ³⁷⁹
CF _{SSP, MF}	= Summer System Peak Coincidence Factor for Heat Pumps in multi-family homes (during

³⁷⁴ All baseline replacement costs are consistent with their respective measures and include inflation rate of 1.91%.

³⁷⁵ Average retail cost of ENERGY STAR certified portable heat pumps, as of 6/2024 and collected by Ameren. See 'PHP Cost and Efficiencies 20240605.xls'.

³⁷⁶ Based upon costs provided in 5.1.7 ENERGY STAR and CEE Tier 2 Room Air Conditioner.

³⁷⁷ Based on data provided by MidAmerican in April 2018 summarizing survey results from 11 HVAC suppliers in Iowa.

³⁷⁸ Based on analysis of metering results from 24 heat pumps in Ameren Illinois service territory in PY5 coincident with AIC's 2010 system peak; 'Impact and Process Evaluation of Ameren Illinois Company's Residential HVAC Program (PY5)'.

³⁷⁹ Based on analysis of Itron eShape data for Missouri, calibrated to Illinois loads, supplied by Ameren. The average AC load over the PJM peak period (1-5pm, M-F, June through August) is divided by the maximum AC load during the year.

$$\begin{aligned}
 & \text{system peak hour)} \\
 & = 67\%^{380} \\
 CF_{PJM, MF} & = \text{PJM Summer Peak Coincidence Factor for Heat Pumps in multi-family homes (average during peak period)} \\
 & = 28.5\%
 \end{aligned}$$

Algorithm

CALCULATION OF SAVINGS

ELECTRIC ENERGY SAVINGS AND FOSSIL FUEL SAVINGS

Non fuel switch measures (if heat pump is being installed for cooling only, only calculate the cooling impact below):

$$\Delta kWh_{\text{Non Fuel Switch}} = \text{ASHPSiteCoolingImpact} + \text{ASHPSiteHeatingImpact}$$

Where:

$$\begin{aligned}
 \text{ASHPSiteCoolingImpact} & = ((\text{CoolingLoad}/\text{DuctlessSave} * (1/(\text{SEER2_base} * (1 - \text{DeratingCool}_{\text{Base}})))) - (\text{CoolingLoad} * 1/(\text{SEER2_ee} * (1 - \text{DeratingCool}_{\text{Eff}}))))/1000 \\
 \text{ASHPSiteHeatingImpact} & = ((\text{HeatLoad_Disp}/\text{DuctlessSave} * (1/(\text{HSPF2_base} * \text{HSPF2_ClimateAdj} * (1 - \text{DeratingHeat}_{\text{Base}})))) - (\text{HeatLoad_Disp} * 1/(\text{HSPF2_ee} * \text{HSPF2_ClimateAdj} * (1 - \text{DeratingHeat}_{\text{Eff}})))) / 1000
 \end{aligned}$$

Fuel switch measures:

Fuel switch measures must produce positive total lifecycle energy savings (i.e., reduction in Btus at the premises) in order to qualify. This is determined as follows:

$$\begin{aligned}
 \text{SiteEnergySavings (MMBTUs)} & = \text{FuelSwitchSavings} + \text{NonFuelSwitchSavings} \\
 \text{FuelSwitchSavings} & = \text{GasHeatReplaced} - \text{ASHPSiteHeatConsumed} \\
 \text{NonFuelSwitchSavings} & = \text{FurnaceFanSavings} + \text{ASHPSiteCoolingImpact}
 \end{aligned}$$

Where:

$$\begin{aligned}
 \text{GasHeatReplaced} & = (\text{HeatLoad_Disp}/\text{DuctlessSave} * 1/\text{AFUE}_{\text{base}}) / 1,000,000 \\
 \text{FurnaceFanSavings} & = (\text{FurnaceFlag} * \text{HeatLoad_Disp}/\text{DuctlessSave} * 1/\text{AFUE}_{\text{base}} * F_e) / 1,000,000 \\
 \text{ASHPSiteHeatConsumed} & = ((\text{HeatLoad_Disp} * (1/(\text{HSPF2_ee} * \text{HSPF2_ClimateAdj} * \text{PD_Adj} * (1 - \text{DeratingHeat}_{\text{Eff}})))) / 1000 * 3412) / 1,000,000 \\
 \text{ASHPSiteCoolingImpact} & = ((\text{CoolingLoad}/\text{DuctlessSave} * (1/(\text{SEER2_base} * (1 - \text{DeratingCool}_{\text{Base}})))) - ((\text{CoolingLoad} * 1/(\text{SEER2_ee} * (1 - \text{DeratingCool}_{\text{Eff}}))))/1000 * 3412) / 1,000,000
 \end{aligned}$$

If SiteEnergySavings calculated above is positive, the measure is eligible.

The appropriate savings claim is dependent on which utilities are supporting the measure as provided in a table below:

³⁸⁰ Multifamily coincidence factors both from; *All-Electric Homes PY6 Metering Results: Multifamily HVAC Systems*, Cadmus, October 2015

Measure supported by:	Electric Utility claims (kWh):	Gas Utility claims (therms):
Electric utility only	SiteEnergySavings * 1,000,000/3,412	N/A
Electric and gas utility (Note utilities may make alternative agreements to how savings are allocated as long as total MMBtu savings remains the same).	%IncentiveElectric * SiteEnergySavings * 1,000,000/3,412	%IncentiveGas * SiteEnergySavings * 10
Gas utility only	N/A	SiteEnergySavings * 10

Note for Early Replacement measures, the efficiency (SEER, EER and HSPF) and furnace fan energy consumption (F_e) terms of the existing unit should be used for the remaining useful life of the existing equipment (6 years for ASHP and Central AC, 7 years for furnace, 8 years for boilers, 16 years for electric resistance), and the efficiency and F_e terms for a new baseline unit should be used for the remaining years of the measure. See assumptions below.

Programs where existing system is unknown

In programs where the existing fuel or system type is unknown, savings should be apportioned between the Fuel Switch and Non- Fuel Switch scenarios, as follows:

$$\text{Savings from Non-Fuel Switch (kWh)} = (1 - \%FuelSwitch) * \Delta kWh_{\text{Non Fuel Switch}}$$

Plus

$$\begin{aligned} \text{Savings from Fuel Switch (MMBtu converted to appropriate fuel as table above)} \\ = \%FuelSwitch * SiteEnergySavings \text{ (MMBTUs)} \end{aligned}$$

Where:

$\%FuelSwitch$ = The percentage of replacements resulting in fuel-switching.
 = 1 when fuel switching is known, 0 if non fuel switch
 = when unknown, e.g. midstream program, determine via evaluation

CoolingLoad = Annual cooling load for the building
 = $FLH_{cooling} * Capacity_{ASHPCool}$

$FLH_{cooling}$ = Full load hours of air conditioning
 = dependent on location:

Climate Zone (City based upon)	FLH_cooling (single family) ³⁸¹	FLH_cooling (multifamily) ³⁸²	FLH_cooling ³⁸³ (Ductless Minisplit HP providing supplemental cooling or Portable HP in IQ homes) ³⁸⁴	FLH_cooling (Portable HP in non-IQ homes) ³⁸⁵
1 (Rockford)	547	499	331	235
2 (Chicago)	709	629	429	261
3 (Springfield)	779	707	472	340
4 (Belleville)	1082	982	655	447
5 (Marion)	956	868	579	396
Weighted Average ³⁸⁶				
ComEd	676	603	409	256
Ameren	875	791	530	364
Statewide	731	655	443	286

Use Multifamily if: Building has meets utility’s definition for multifamily and system serves single unit. For residential sized systems serving 2 or more units, assume single family hours. For central systems use Volume 2 Commercial and Industrial Measures.

Capacity_ASHPool = Cooling Output Capacity of Air Source Heat Pump (Btu/hr)
= Actual (1 ton = 12,000Btu/hr)

DuctlessSave = Factor used to adjust ducted heating or cooling load displaced by ductless or portable HP systems that are not subject to losses from existing ductwork.
= 1-0.15 = 0.85 for ducted system displaced by ductless or portable HP system
= 1.00 for ducted system displaced by ducted system or ductless system displaced by ductless or portable HP system

SEER2_base = Seasonal Energy Efficiency Ratio of baseline unit (kBtu/kWh), converted to SEER2 if rating is in SEER. For early replacment measures, the actual SEER2 rating where it is possible to measure or reasonably estimate should be used for the remaining useful life of the existing equipment (6 years for ASHP and Central AC). If using rated efficiencies, derate efficiency value by 1% per year (maximum of 30 years) to account for degradation over time,³⁸⁷ or if unknown assume default provided below. If unknown value is used, it should not be derated by age.

³⁸¹ Full load hours for Chicago, Moline and Rockford are provided in “Final Evaluation Report: Central Air Conditioning Efficiency Services (CACES), 2010, Navigant Consulting”, p.33. An average FLH/Cooling Degree Day (from NCDC) ratio was calculated for these locations and applied to the CDD of the other locations in order to estimate FLH. There is a county mapping table in Volume 1, Section 3.7 providing the appropriate city to use for each county of Illinois. During update cycle for version v.12, applied percent change of CDD65, NCEI Annual Normals from 30 yr data set (1981-2010) to more recent 15 yr data (2006-2020) to all FLHcool values

³⁸² Ibid.

³⁸³ Full load hours for a ductless minisplit HP providing supplemental cooling to a limited space previously unserved or underserved by existing equipment, is based on the ratio of the EFLH for conventional cooling systems to the EFLH of DMSHPs provided in the "Ductless Mini Split Heat Pump Impact Evaluation" 2016, The Cadmus Group, pg. 6 (61%).

³⁸⁴ If unknown, assume supplemental if ductless minisplit heat pump <18,000 Btu/h.

³⁸⁵ Full load hours for non-IQ portable heat pumps is assumed to be consistent with Room AC EFLHs.

³⁸⁶ Weighting for Ameren is based on electric accounts in each of the cooling zones. Weighting for ComEd and Statewide average is based on number of occupied residential housing units in each zone. ComEd is weighted average of Zones 1-2. Alternative program-weighted assumptions can be used if appropriate.

³⁸⁷ Justification for degradation factors can be found on page 14 of ‘AIC HVAC Metering Study Memo FINAL 2_28_2018’. Estimate efficiency as (Rated Efficiency * (1-0.01)^Equipment Age).

Baseline/Existing Cooling System	SEER2_base		
	Early Replacement (Remaining useful life of existing equipment)	Early Replacement (Remaining measure life)	Time of Sale or New Construction
Air Source Heat Pump – Standard sized	9.2 SEER2 ³⁸⁸	14.3 SEER2 ³⁸⁹	
Air Source Heat Pump – Space constrained	9.2 SEER2	11.9 SEER2	
Central AC – Standard sized	9.2 SEER2 ³⁹⁰	13.4 SEER2 ³⁹¹	
Central AC – Space constrained	9.2 SEER2	11.7 SEER2	
Room AC	7.7 CEER ³⁹²	Select appropriate baseline from measure 5.1.7. Assume same capacity as efficient. If unknown assume 10.9 CEER.	
No central cooling	Make '1/SEER2_exist' = 0 ³⁹³	13.4 SEER2 ³⁹⁴	
Unknown, installing ducted ³⁹⁵	9.2 SEER2	13.9 SEER2	
Unknown, installing ductless	9.5 SEER2	13.7 SEER2	

SEER2_ee = Rated Seasonal Energy Efficiency Ratio of ENERGY STAR unit (kBtu/kWh), converted to SEER2 if rating is in SEER (or CEER for portable heat pumps)

= Actual or program-defined minimum if unknown.

DeratingCool_{Eff} = Efficient ASHP Cooling derating

= 0% if Quality Installation is performed

= 10% if Quality Installation is not performed or unknown³⁹⁶

DeratingCool_{Base} = Baseline Cooling derating

= 10%

HeatLoad_Displ = Annual heat load for the building displaced by the ASHP (Btus)

= FLH_ASHPh_{heat} * Capacity_ASHPh_{heat} * HeatLoadFactor

³⁸⁸ Based on Opinion Dynamics and Cadmus metering study of Ameren HVAC program participants; See 'AIC HVAC Metering Study Memo FINAL 2_28_2018', converted to SEER2.

³⁸⁹ Minimum Federal Standard as of 1/1/2023

³⁹⁰ Based on Opinion Dynamics and Cadmus metering study of Ameren HVAC program participants; See 'AIC HVAC Metering Study Memo FINAL 2_28_2018' Converted to SEER2.

³⁹¹ Minimum Federal Standard; Federal Register, Vol. 66, No. 14, Monday, January 22, 2001/Rules and Regulations, p. 7170-7200.

³⁹² Based on Nexus Market Research Inc, RLW Analytics, December 2005; "Impact, Process, and Market Study of the Connecticut Appliance Retirement Program: Overall Report."

³⁹³ If there is no central cooling in place but the incentive encourages installation of a new ASHP with cooling, the added cooling load should be subtracted from any heating benefit.

³⁹⁴ Assumes that the decision to replace existing systems includes desire to add cooling.

³⁹⁵ Values represent the weighted average SEER baseline values (converted to SEER2) reflecting the assumed shares of installed ASHP replacing given baseline technologies (e.g. ASHP/electric resistance or furnace/boiler) by fuel type. Assumed shares are based on Opinion Dynamics and Guidehouse analysis of 2018-2021 Ameren and ComEd HVAC (downstream) program tracking data. For further details, see '2018-2021 AIC Res HVAC Data ASHP Baseline TRM Update 2023-06-20.xls'.

³⁹⁶ Based on Cadmus assumption provided in preparation of the 2014 Interstate Power and Light TRM based upon proper refrigerant charge, evaporator airflow, and unit sizing. Appears conservative in comparison to ENERGY STAR statements (see 'Sponsoring an ENERGY STAR Verified HVAC Installation (ESVI) Program') and so could be considered for future evaluation.

FLH_ASHPheat = Full load hours of heat pump heating
 = Dependent on location and home type:

Climate Zone (City based upon)	FLH_ASHPheat (single family and multifamily) ³⁹⁷	FLH_ASHPheat ³⁹⁸ (Ductless Minisplit HP providing supplemental heating or Portable HP) ³⁹⁹
1 (Rockford)	1924	716
2 (Chicago)	1726	642
3 (Springfield)	1708	636
4 (Belleville)	1195	445
5 (Marion/Murphysboro)	1270	473
Weighted Average ⁴⁰⁰		
ComEd	1766	657
Ameren	1547	576
Statewide	1700	633

Capacity_ASHPheat = Heating Output Capacity of Air Source Heat Pump at 47° F (Btu/hr)
 = Actual (1 ton = 12,000Btu/hr)

HeatLoadFactor = Portion of HeatLoad displaced by ASHP in partial displacement applications. Varies by Switchover Temperature and Climate Region. If Switchover Temperature is unknown, use 32F. For portable heat pumps, unless it can be confirmed that the unit will be used through the heating season, use 47F to reflect likely behavior of unit being removed when temperature falls below this temperature.
 = 1.0 if full displacement (e.g. cold climate heat pumps) or if switchover temperature is lower than 17F, if Partial Displacement with simultaneous operation.

Climate Zone (City based upon)	HeatLoadFactor (by Switchover Temperature)										
	47F	44F	41F	38F	35F	32F	29F	26F	23F	20F	17F
1 (Rockford)	8%	14%	18%	22%	32%	42%	50%	63%	70%	74%	81%
2 (Chicago)	8%	14%	20%	26%	37%	48%	56%	70%	77%	80%	86%
3 (Springfield)	8%	15%	21%	27%	43%	57%	63%	73%	79%	82%	87%

³⁹⁷ Full load heating hours for heat pumps are provided for Rockford, Chicago and Springfield in the ENERGY STAR Calculator. Estimates for the other locations were calculated based on the FLH to Heating Degree Day (from NCDC) ratio. VEIC consider ENERGY STAR estimates to be high due to oversizing not being adequately addressed. Using average Illinois billing data (from ICC Commerce Commission) VEIC estimated the average gas heating load and used this to estimate the average home heating output (using 83% average gas heat efficiency). Dividing this by a typical 36,000 Btu/hr ASHP gives an estimate of average ASHP FLH_heat of 1821 hours. We used the ratio of this value to the average of the locations using the ENERGY STAR data (1994 hours) to scale down the ENERGY STAR estimates. There is a county mapping table in Volume 1, Section 3.7 providing the appropriate city to use for each county of Illinois. During update cycle for version v.12, applied percent change of HDD60, NCEI Annual Normals from 30 yr data set (1981-2010) to more recent 15 yr data (2006-2020) to all FLHheat values

³⁹⁸ Full load hours for a ductless minisplit HP providing supplemental heating to a limited space previously unserved or underserved by existing equipment, is based on the ratio of the EFLH for conventional heating systems to the EFLH of DMSHPs provided in the "Ductless Mini Split Heat Pump Impact Evaluation" 2016, The Cadmus Group, pg. 6 (37%).

³⁹⁹ If unknown, assume supplemental if ductless minisplit heat pump <18,000 Btu/h.

⁴⁰⁰ Weighting for Ameren is based on electric heat accounts in each of the heating zones. Weighting for ComEd and Statewide average is based on number of occupied residential housing units in each zone. ComEd is weighted average of Zones 1-2. Alternative program-weighted assumptions can be used if appropriate.

Climate Zone (City based upon)	HeatLoadFactor (by Switchover Temperature)										
	47F	44F	41F	38F	35F	32F	29F	26F	23F	20F	17F
4 (Belleville)	13%	21%	30%	37%	48%	61%	71%	80%	88%	92%	95%
5 (Marion)	14%	23%	33%	41%	59%	72%	79%	88%	92%	95%	97%
Weighted Average ⁴⁰¹											
ComEd	8%	14%	20%	26%	37%	48%	56%	70%	77%	80%	86%
Ameren	10%	16%	24%	30%	44%	57%	64%	75%	81%	85%	90%
Statewide	8%	15%	21%	27%	39%	50%	58%	71%	78%	81%	87%

HSPF2_base = Heating Seasonal Performance Factor 2 of baseline heating system (kBtu/kWh), converted to HSPF2 if rating is in HSPF. For early replacement measures, use actual HSPF2 rating where it is possible to measure or reasonably estimate for the remaining useful life of the existing equipment (6 years for ASHP, 16 years for electric resistance). If using rated efficiencies, derate efficiency value by 1% per year (maximum of 30 years) to account for degradation over time,⁴⁰² or if unknown assume default. If unknown value is used, it should not be derated by age.

Baseline/ Existing Heating System	HSPF2_base		
	Early Replacement (Remaining useful life of existing equipment)	Early Replacement (Remaining measure life)	Time of Sale or New Construction
Air Source Heat Pump – standard sized	4.91 HSPF2 ⁴⁰³	7.5 HSPF2 ⁴⁰⁴	
Air Source Heat Pump – space constrained	4.91 HSPF2	6.3 HSPF2	
Electric Resistance	3.41 HSPF2 ⁴⁰⁵		
Unknown, installing ducted ⁴⁰⁶	4.5 HSPF2	5.9 HSPF2	
Unknown, installing ductless	4.4 HSPF2	5.3 HSPF2	

HSPF2_ee = Heating Seasonal Performance Factor 2 of efficient Air Source Heat Pump, converted to HSPF2 if rating is in HSPF (kBtu/kWh)
 = Actual or program-defined minimum if unknown⁴⁰⁷

DeratingHeat_{Eff} = Efficient ASHP Heating derating
 = 0% if Quality Installation is performed

⁴⁰¹ Weighting for Ameren is based on electric heat accounts in each of the heating zones. Weighting for ComEd and Statewide average is based on number of occupied residential housing units in each zone. ComEd is weighted average of Zones 1-2. Alternative program-weighted assumptions can be used if appropriate.

⁴⁰² Justification for degradation factors can be found on page 14 of ‘AIC HVAC Metering Study Memo FINAL 2_28_2018’. Estimate efficiency as (Rated Efficiency * (1-0.01)^{Equipment Age}).

⁴⁰³ Based on Opinion Dynamics and Cadmus metering study of Ameren HVAC program participants; See ‘AIC HVAC Metering Study Memo FINAL 2_28_2018’ Converted to HSPF2.

⁴⁰⁴ Based on Minimum Federal Standard effective 1/1/2023.

⁴⁰⁵ Electric resistance has a COP of 1.0 which equals 1/0.293 = 3.41 HSPF.

⁴⁰⁶ Values represent the weighted average HSPF (converted to HSPF2) baseline values reflecting the assumed shares of installed ASHP replacing given baseline technologies (e.g. ASHP/electric resistance or furnace/boiler) by fuel type. Assumed shares are based on Opinion Dynamics and Guidehouse analysis of 2018-2021 Ameren and ComEd HVAC (downstream) program tracking data. For further details, see ‘2018-2021 AIC Res HVAC Data ASHP Baseline TRM Update 2023-06-20.xls’.

⁴⁰⁷ ENERGY STAR minimum.

= 10% if Quality Installation is not performed⁴⁰⁸

DeratingHeat_{Base} = Baseline Heating derating

= 10%

HSPF2_ClimateAdj= Adjustment factor to account for observed discrepancy between seasonal heating performance relative to rated HSPF2 as provided by standard AHRI 210/240 rating conditions.⁴⁰⁹

= 100% if Partial Displacement and switchover temperature greater than 17F, otherwise:

City (county based upon)	HSPF2_ClimateAdj
1 (Rockford)	77%
2 (Chicago)	77%
3 (Springfield)	91%
4 (Belleville)	91%
5 (Marion)	91%
Weighted Average ⁴¹⁰	
ComEd	77%
Ameren	89%
Statewide	80%

PD_Adj

= Adjustment multiplier to account for increased heat pump efficiency in Partial Displacement applications when there is no electric resistance backup and switchover temperature is higher than 17F. Varies by Switchover Temperature and Climate Region. If Switchover Temperature is unknown, use 32F.

= 1.0 if full displacement (e.g. cold climate heat pumps) or if switchover temperature is lower than 17F, or if Partial Displacement with simultaneous operation, or if Portable HP.

Climate Zone (City based upon)	PD_Adj (by Switchover Temperature)										
	47F	44F	41F	38F	35F	32F	29F	26F	23F	20F	17F
1 (Rockford)	155%	151%	148%	146%	141%	137%	134%	131%	128%	127%	125%
2 (Chicago)	155%	151%	147%	144%	140%	137%	134%	131%	129%	128%	126%

⁴⁰⁸ Based on Cadmus assumption provided in preparation of the 2014 Interstate Power and Light TRM based upon proper refrigerant charge, evaporator airflow, and unit sizing, Assumed consistent for heating and cooling. Appears conservative in comparison to ENERGY STAR statements (see 'Sponsoring an ENERGY STAR Verified HVAC Installation (ESVI) Program') and so could be considered for future evaluation.

⁴⁰⁹ Adjustment factors are based on findings from NEEA, July 2020 'EXP07:19 Load-based and Climate-Specific Testing and Rating Procedures for Heat Pumps and Air Conditioners'. See 'NEEA HP data' for calculation. Findings were consistent with other reviewed sources including ASHRAE, 2020 'Right-Sizing Electric Heat Pump and Auxiliary Heating for Residential Heating Systems Based on Actual Performance Associated with Climate Zone' and Cadmus, 2022 'Residential ccASHP Building Electrification Study'. The difference between HSPF and HSPF2 ratings is based on the change in testing procedure that will correct for some of this effect where ducted systems will have an approximately 9% lower HSPF2 rating as compared to HSPF, based on CEE presentation, July 2022, 'Testing Testing, M1, 2, 3: Transitioning to New Federal Minimum Standards'.

⁴¹⁰ Weighting for Ameren is based on electric heat accounts in each of the heating zones. Weighting for ComEd and Statewide average is based on number of occupied residential housing units in each zone. ComEd is weighted average of Zones 1-2. Alternative program-weighted assumptions can be used if appropriate.

Climate Zone (City based upon)	PD_Adj (by Switchover Temperature)										
	47F	44F	41F	38F	35F	32F	29F	26F	23F	20F	17F
3 (Springfield)	155%	151%	147%	145%	139%	136%	134%	132%	130%	129%	127%
4 (Belleville)	155%	151%	148%	145%	142%	138%	136%	133%	131%	130%	129%
5 (Marion)	155%	151%	147%	145%	140%	138%	136%	134%	133%	132%	131%
Weighted Average ⁴¹¹											
ComEd	155%	151%	147%	144%	140%	137%	134%	131%	129%	128%	126%
Ameren	155%	151%	147%	145%	140%	137%	135%	132%	130%	129%	128%
Statewide	155%	151%	147%	144%	140%	137%	134%	131%	129%	128%	126%

AFUE_{base} = Baseline Annual Fuel Utilization Efficiency Rating. For early replacement measures, use actual AFUE rating where it is possible to measure or reasonably estimate for the remaining useful life of the existing equipment (6 years for furnace, 8 years for boilers). If using rated efficiencies, derate efficiency value by 1% per year (maximum of 30 years) to account for degradation over time,⁴¹² or if unknown assume default. If unknown value is used, it should not be derated by age.

Baseline/ Existing Heating System	AFUE _{base}		
	Early Replacement (Remaining useful life of existing equipment) ⁴¹³	Early Replacement (Remaining measure life)	Time of Sale or New Construction
Furnace	64.4%	80%	80%
Boiler	61.6%	84%	84%
Unknown ⁴¹⁴	80%	80.1%	80.1%

FurnaceFlag = 1 if system replaced is a fossil fuel furnace, 0 if not.

F_e = Furnace Fan energy consumption as a percentage of annual fuel consumption

For Early Replacement (1st 6 years) F_{e_Exist} = 3.14%⁴¹⁵

For New Construction, Time of Sale and early replacement (remaining 10 years)

F_{e_New} = 1.88%⁴¹⁶

3412 = Btu per kWh

%IncentiveElectric = % of total incentive paid by electric utility

⁴¹¹ Weighting for Ameren is based on electric heat accounts in each of the heating zones. Weighting for ComEd and Statewide average is based on number of occupied residential housing units in each zone. ComEd is weighted average of Zones 1-2. Alternative program-weighted assumptions can be used if appropriate.

⁴¹² Justification for degradation factors can be found on page 14 of 'AIC HVAC Metering Study Memo FINAL 2_28_2018'. Estimate efficiency as (Rated Efficiency * (1-0.01)^{Equipment Age}).

⁴¹³ Average nameplate efficiencies of all Early Replacement qualifying equipment in Ameren PY3-PY4.

⁴¹⁴ Values represent the weighted average AFUE baseline values reflecting the assumed shares of installed ASHP replacing given baseline technologies (e.g. ASHP/electric resistance or furnace/boiler) by fuel type. Assumed shares are based on Opinion Dynamics and Guidehouse analysis of 2018-2021 Ameren and ComEd HVAC (downstream) program tracking data. For further details, see '2018-2021 AIC Res HVAC Data ASHP Baseline TRM Update 2022-07-11.xls'.

⁴¹⁵ F_e is not one of the AHRI certified ratings provided for residential furnaces, but can be reasonably estimated from a calculation based on the certified values for fuel energy (E_f in MMBtu/yr) and E_{ae} (kWh/yr). An average of a 300 record sample (non-random) out of 1495 was 3.14%. This is, appropriately, ~50% greater than the ENERGY STAR version 3 criteria for 2% F_e. See "Programmable Thermostats Furnace Fan Analysis.xlsx" for reference.

⁴¹⁶ New furnaces are required to have ECM fan motors installed. Comparing E_{ae} to E_f for furnaces on the AHRI directory as above, indicates that F_e for new furnaces is on average 1.88%.

= Actual
%IncentiveGas = % of total incentive paid by gas utility
= Actual

Non Fuel Switch Illustrative Examples

Time of Sale using ASHP baseline:

For example, an ASHP is installed in a single-family home in Marion with the following nameplate information: 15.2 SEER2, 12.4 EER2, 9 HSPF2; Cooling capacity: 34,800 Btuh; Heating capacity at 47°F: 33,000 Btuh; Heating capacity at 17°F: 21,200 Btuh with Quality Installation;

$$\Delta kWh_{\text{Non Fuel Switch}} = \text{ASHPSiteCoolingImpact} + \text{ASHPSiteHeatingImpact}$$

$$\begin{aligned} \text{ASHPSiteCoolingImpact} &= (((956 * 34,800)/1 * 1/(14.3 * (1 - 0.1))) - (956 * 34,800 * 1/(15.2 * (1 - 0)))) / 1000 \\ &= 396 \text{ kWh} \end{aligned}$$

$$\begin{aligned} \text{ASHPSiteHeatingImpact} &= (((1,270 * 33,000 * 1)/1 * 1/(7.5 * 0.91 * (1 - 0.1)) - 1/(9 * 0.91 * (1-0)))) / 1000 \\ &= 1,706 \text{ kWh} \end{aligned}$$

$$\Delta kWh_{\text{Non Fuel Switch}} = 396 + 1706 = 2,102 \text{ kWh}$$

Early Replacement:

For example, a 15.2 SEER2, 12.4 EER2, 9 HSPF2 Air Source Heat Pump with nameplate information as above replaces an existing working Air Source Heat Pump with unknown efficiency ratings in a single family home in Marion:

ΔkWh for remaining life of existing unit (1st 6 years):

$$\begin{aligned} \text{ASHPSiteCoolingImpact} &= (((956 * 34,800)/1 * 1/(9.3 * (1 - 0.1))) - (956 * 34,800 * 1/(15.2 * (1 - 0)))) / 1000 \\ &= 1786 \text{ kWh} \end{aligned}$$

$$\begin{aligned} \text{ASHPSiteHeatingImpact} &= (((1,270 * 33,000 * 1)/1 * 1/(5.54 * 0.91 * (1 - 0.1)) - 1/(9 * 0.91 * (1-0)))) / 1000 \\ &= 4120 \text{ kWh} \end{aligned}$$

$$\Delta kWh_{\text{Non Fuel Switch}} = 1786 + 4102 = 5,888 \text{ kWh}$$

ΔkWh for remaining measure life (next 12 years):

$$= 2,102 \text{ kWh (as example above)}$$

Fuel Switch Illustrative Examples

[for illustrative purposes, 50:50 Incentive is used for joint programs]

New construction using gas furnace and central AC baseline:

For example a 3-ton (Cooling capacity of 34,800Btuh and Heating capacity of 33,000 Btuh), 15.2 SEER2, 12.4 EER2, 9 HSPF2 ducted Air Source Heat Pump installed in single-family home in Marion with Quality Installation, in place of a 81,000 Btuh natural gas furnace and 3 ton Central AC unit:

$$\begin{aligned} \text{SiteEnergySavings (MMBTUs)} &= \text{GasHeatReplaced} + \text{FurnaceFanSavings} - \text{ASHPSiteHeatConsumed} + \\ &\quad \text{ASHPSiteCoolingImpact} \end{aligned}$$

$$\begin{aligned} \text{GasHeatReplaced} &= ((\text{HeatLoad_Disp/DuctlessSave} * 1/\text{AFUE}_{\text{base}}) / 1,000,000) \\ &= (((1270 * 33,000 * 1)/1 * 1/0.8) / 1000000) \\ &= 52.4 \text{ MMBtu} \end{aligned}$$

$$\begin{aligned} \text{FurnaceFanSavings} &= (\text{FurnaceFlag} * \text{HeatLoad_Disp/DuctlessSave} * 1/\text{AFUE}_{\text{base}} * \text{Fe_New}) / 1,000,000 \\ &= (1 * (1270 * 33,000 * 1)/1 * 1/0.8 * 0.0188) / 1,000,000 \\ &= 1.0 \text{ MMBtu} \end{aligned}$$

$$\begin{aligned} \text{ASHPSiteHeatConsumed} &= ((\text{HeatLoad_Disp} * (1/(\text{HSPF2_ee} * \text{HSPF2_ClimateAdj} * \text{PDAj} * (1 - \text{DeratingHeat}_{\text{Eff}})))) / 1000 * 3412) / 1,000,000 \\ &= (((1,270 * 33,000 * 1)/1 * 1/(9 * 0.91 * 1 * (1-0)))) / 1000 * 3412 / 1,000,000 \\ &= 17.5 \text{ MMBtu} \end{aligned}$$

Fuel Switch Illustrative Example continued

$$\begin{aligned} \text{ASHPSiteCoolingImpact} &= ((\text{CoolingLoad}/\text{DuctlessSave} * (1/(\text{SEER2_base} * (1 - \text{DeratingCool}_{\text{Base}})) - 1/(\text{SEER2_ee} * (1 - \text{DeratingCool}_{\text{Eff}}))))/1000) * 3412) / 1,000,000 \\ &= (((956 * 34,800 * 1)/1 * (1/(13.4 * (1-0.1)) - 1/(15.2 * (1-0)))) / 1000 * 3412)/1,000,000 \\ &= 1.9 \text{ MMBtu} \end{aligned}$$

$$\text{SiteEnergySavings (MMBTUs)} = 52.4 + 1.0 - 17.5 + 1.9 = 37.8 \text{ MMBtu [Measure is eligible]}$$

Savings would be claimed as follows:

Measure supported by:	Electric Utility claims:	Gas Utility claims:
Electric utility only	37.8 * 1,000,000/3412 = 11,079 kWh	N/A
Electric and gas utility	0.5 * 37.8 * 1,000,000/3412 = 5,539 kWh	0.5 * 37.8 * 10 = 189 Therms
Gas utility only	N/A	37.8 * 10 = 378 Therms

Early Replacement fuel switch:

For example a three ton (Cooling capacity of 34,800Btuh and Heating capacity of 33,000 Btuh), 15.2 SEER2, 12.4 EER2, 9 HSPF2 Air Source Heat Pump installed in single-family home in Marion with Quality Installation, replaces an existing working natural gas furnace and 3-ton Central AC unit with unknown efficiency ratings:

$$\text{LifetimeSiteEnergySavings (MMBTUs)} = \text{LifetimeGasHeatReplaced} + \text{LifetimeFurnaceFanSavings} - \text{LifetimeASHPSiteHeatConsumed} + \text{LifetimeASHPSiteCoolingImpact}$$

$$\begin{aligned} \text{LifetimeGasHeatReplaced} &= [(\text{HeatLoad_Disp}/\text{DuctlessSave} * 1/\text{AFUE}_{\text{exist}}) / 1,000,000] * 6 \text{ years} + [(\text{HeatLoad_Disp}/\text{DuctlessSave} * 1/\text{AFUE}_{\text{base}}) / 1,000,000] * 10 \text{ years} \\ &= (((1270 * 33000 * 1)/1 * 1/0.644) / 1000000) * 6 + (((1270 * 33000 * 1)/1 * 1/0.8) / 1000000) * 10 \\ &= 914.3 \text{ MMBtu} \end{aligned}$$

$$\begin{aligned} \text{LifetimeFurnaceFanSavings} &= ((\text{FurnaceFlag} * \text{HeatLoad_Disp}/\text{DuctlessSave} * 1/\text{AFUE}_{\text{exist}} * \text{F}_{\text{e_Exist}}) / 1,000,000) * 6 \text{ years} + ((\text{FurnaceFlag} * \text{HeatLoad_Disp}/\text{DuctlessSave} * 1/\text{AFUE}_{\text{base}} * \text{F}_{\text{e_New}}) / 1,000,000) * 10 \text{ years} \\ &= ((1 * (1270 * 33,000 * 1)/1 * 1/0.644 * 0.0314) / 1,000,000) * 6 + ((1 * (1270 * 33,000 * 1)/1 * 1/0.8 * 0.0188) / 1,000,000) * 10 \\ &= 22.1 \text{ MMBtu} \end{aligned}$$

$$\begin{aligned} \text{LifetimeASHPSiteHeatConsumed} &= ((\text{HeatLoad_Disp}/\text{DuctlessSave} * (1/(\text{HSPF2_ee} * \text{HSPF2_ClimateAdj} * \text{PD_Adj} * (1 - \text{DeratingHeat}_{\text{Eff}})))) / 1000 * 3412) / 1,000,000 * 16 \text{ years} \\ &= (((1,270 * 33,000 * 1)/1 * (1/(9 * 0.91 * 1.001 * 1 * (1-0)))) / 1000 * 3412)/1,000,000 * 16 \\ &= 279 \text{ MMBtu} \end{aligned}$$

Fuel Switch Illustrative Example continued

$$\begin{aligned} \text{LifetimeASHPSiteCoolingImpact} &= (((\text{CoolingLoad}/\text{DuctlessSave} * (1/(\text{SEER2_exist} * (1 - \text{DeratingCool}_{\text{Base}})) - \\ & 1/(\text{SEER2_ee} * \text{SEER2adj} * (1 - \text{DeratingCool}_{\text{Eff}}))))/1000 * 3412)/1,000,000 * 6 \text{ years}) + \\ & (((\text{CoolingLoad}/\text{DuctlessSave} * (1/(\text{SEER2_base} * (1 - \text{DeratingCool}_{\text{Base}})) - 1/(\text{SEER2_ee} * \text{SEER2adj} * (1 - \\ & \text{DeratingCool}_{\text{Eff}}))))/1000 * 3412)/1,000,000 * 10 \text{ years}) \\ &= (((956 * 34,800)/1 * (1/(9.3 * (1-0.1)) - 1/(15.2 * (1-0)))) / 1000 * 3412)/1,000,000 * 6) + (((956 * 34,800)/1 \\ & * (1/(13.4 * (1-0.1)) - 1/(15.2 * (1-0)))) / 1000 * 3412)/1,000,000 * 10) \\ &= 56.0 \text{ MMBtu} \end{aligned}$$

$$\text{LifetimeSiteEnergySavings (MMBTUs)} = 914.3 + 22.1 - 279 + 56.0 = 713.4 \text{ MMBtu [Measure is eligible]}$$

First 6 years:

$$\text{SiteEnergySavings_FirstYear (MMBTUs)} = \text{GasHeatReplaced} + \text{FurnaceFanSavings} - \text{ASHPSiteHeatConsumed} + \text{ASHPSiteCoolingImpact}$$

$$\begin{aligned} \text{GasHeatReplaced} &= [(\text{HeatLoad_Disp}/\text{DuctlessSave} * 1/\text{AFUE}_{\text{Exist}}) / 1,000,000] \\ &= (((1270 * 33,000 * 1)/1 * 1/0.644) / 1000000) \\ &= 65.1 \text{ MMBtu} \end{aligned}$$

$$\begin{aligned} \text{FurnaceFanSavings} &= (\text{FurnaceFlag} * \text{HeatLoad_Disp}/\text{DuctlessSave} * 1/\text{AFUE}_{\text{Exist}} * \text{Fe_Exist}) / \\ & 1,000,000 \\ &= (1 * (1270 * 33,000 * 1)/1 * 1/0.644 * 0.0314) / 1,000,000 \\ &= 2.0 \text{ MMBtu} \end{aligned}$$

$$\begin{aligned} \text{ASHPSiteHeatConsumed} &= ((\text{HeatLoad_Disp}/\text{DuctlessSave} * (1/(\text{HSPF2_ee} * \text{HSPF2_ClimateAdj} * \text{PD_Adj} \\ & * (1 - \text{DeratingHeat}_{\text{Eff}})))) / 1000 * 3412) / 1,000,000 \\ &= (((1,270 * 33,000 * 1)/1 * (1/(9 * 0.91 * 1 * (1-0)))) / 1000 * 3412) / 1,000,000 \\ &= 17.5 \text{ MMBtu} \end{aligned}$$

$$\begin{aligned} \text{ASHPSiteCoolingImpact} &= ((\text{CoolingLoad}/\text{DuctlessSave} * (1/(\text{SEER2_exist} * (1 - \text{DeratingCool}_{\text{Base}})) - \\ & 1/(\text{SEER2_ee} * (1 - \text{DeratingCool}_{\text{Eff}}))))/1000 * 3412) / 1,000,000 \\ &= (((956 * 34,800)/1 * (1/(9.3 * (1-0.1)) - 1/(15.2 * (1-0)))) / 1000 * 3412)/1,000,000 \\ &= 6.1 \text{ MMBtu} \end{aligned}$$

$$\text{SiteEnergySavings_FirstYear (MMBTUs)} = 65.1 + 2.0 - 17.5 + 6.1 = 55.7 \text{ MMBtu}$$

Remaining 10 years:

$$\text{SiteEnergySavings_PostAdj (MMBTUs)} = \text{GasHeatReplaced} + \text{FurnaceFanSavings} - \text{ASHPSiteHeatConsumed} + \text{ASHPSiteCoolingImpact}$$

$$\begin{aligned} \text{GasHeatReplaced} &= (((1270 * 33,000 * 1)/1 * 1/0.8) / 1000000) \\ &= 52.4 \text{ MMBtu} \end{aligned}$$

$$\begin{aligned} \text{FurnaceFanSavings} &= (1 * (1270 * 33,000 * 1)/1 * 1/0.8 * 0.0188) / 1,000,000 \\ &= 1.0 \text{ MMBtu} \end{aligned}$$

Fuel Switch Illustrative Example continued

$$\begin{aligned} \text{ASHPSiteHeatConsumed} &= (((1,270 * 33,000 * 1) / 1 * (1 / (9 * 0.91 * 1 * (1-0)))) / 1000 * 3412) / 1,000,000 \\ &= 17.5 \text{ MMBtu} \end{aligned}$$

$$\begin{aligned} \text{ASHPSiteCoolingImpact} &= (((956 * 34,800) / 1 * (1 / (13.4 * (1-0.1)) - 1 / (15.2 * (1-0)))) / 1000 * 3412) / 1,000,000 \\ &= 1.9 \text{ MMBtu} \end{aligned}$$

$$\text{SiteEnergySavings_PostAdj (MMBTUs)} = 52.4 + 1.0 - 17.5 + 1.9 = 37.8 \text{ MMBtu}$$

Savings would be claimed as follows:

Measure supported by:	Electric Utility claims:	Gas Utility claims:
Electric utility only	First 6 years: $55.7 * 1,000,000 / 3412$ = 16,235 kWh Remaining 10 years: $37.8 * 1,000,000 / 3412$ = 11,079 kWh	N/A
Electric and gas utility	First 6 years: $0.5 * 55.7 * 1,000,000 / 3412$ = 8,162 kWh Remaining 10 years: $0.5 * 37.8 * 1,000,000 / 3412$ = 5,539 kWh	First 6 years: $0.5 * 55.7 * 10$ = 279 Therms Remaining 10 years: $0.5 * 37.8 * 10$ = 189 Therms
Gas utility only	N/A	First 6 years: $55.7 * 10$ = 557 Therms Remaining 10 years: $37.8 * 10$ = 378 Therms

SUMMER COINCIDENT PEAK DEMAND SAVINGS

$$\Delta kW = ((\text{Capacity_cooling} / \text{DuctlessSave} * (1 / (\text{EER2_base} * (1 - \text{DeratingCool}_{\text{Base}})))) - (\text{Capacity_cooling} * 1 / (\text{EER2_ee} * (1 - \text{DeratingCool}_{\text{Eff}})))) / 1000 * \text{CF}$$

Where:

EER2_base = Energy Efficiency Ratio 2 of baseline unit (kBtu/kWh). For early replacement measures, the actual EER2 rating where it is possible to measure or reasonably estimate should be used for the remaining useful life of the existing equipment (6 years for ASHP and Central AC). If using rated efficiencies, derate efficiency value by 1% per year (maximum of 30 years) to account for degradation over time.⁴¹⁷ If unknown, assume default provided below. If unknown value is used, it should not be derated by age.

⁴¹⁷ Justification for degradation factors can be found on page 14 of 'AIC HVAC Metering Study Memo FINAL 2_28_2018'. Estimate efficiency as (Rated Efficiency * (1-0.01)^Equipment Age).

Baseline/Existing Cooling System	EER2_base		
	Early Replacement (Remaining useful life of existing equipment)	Early Replacement (Remaining measure life)	Time of Sale or New Construction
Ducted Air Source Heat Pump – standard sized	7.4 EER2 ⁴¹⁸	9.4 EER2 ⁴¹⁹	
Ductless Air Source Heat Pump – standard sized	7.4 EER2	8.5 EER2	
Air Source Heat Pump – space constrained	7.4 EER2	7.8 EER2	
Central AC – standard sized	7.4 EER2	10.6 EER2	
Central AC – space constrained	7.4 EER2	9.2 EER2	
No central cooling	Make '1/EER2_exist' = 0 ⁴²⁰	10.6 EER2 ⁴²¹	
Unknown ⁴²²	7.4 EER2	9.4 EER2	

EER2_ee = Energy Efficiency Ratio of efficient Air Source Heat Pump (kBtu/hr / kW)
= Actual. If unknown, assume 12.4 EER2.⁴²³

CF_{SSP, SF} = Summer System Peak Coincidence Factor for Heat Pumps in single-family homes (during system peak hour)
= 72%⁴²⁴

CF_{PJM, SF} = PJM Summer Peak Coincidence Factor for Heat Pumps in single-family homes (average during peak period)
= 46.6%⁴²⁵

CF_{SSP, MF} = Summer System Peak Coincidence Factor for Heat Pumps in multi-family homes (during system peak hour)
= 67%⁴²⁶

CF_{PJM, MF} = PJM Summer Peak Coincidence Factor for Heat Pumps in multi-family homes (average during peak period)
= 28.5%

Use Multifamily if: Building meets utility’s definition for multifamily and system serves single unit. For

⁴¹⁸ Based on Opinion Dynamics and Cadmus metering study of Ameren HVAC program participants; See ‘AIC HVAC Metering Study Memo FINAL 2_28_2018’ Converted to EER2.

⁴¹⁹ Assumed consistent with the EER2 requirements in the Federal Standard for Southwest standards (in the absence of standards for Northern states).

⁴²⁰ If there is no central cooling in place but the incentive encourages installation of a new ASHP with cooling, the added cooling load should be subtracted from any heating benefit.

⁴²¹ Assumes that the decision to replace existing systems includes desire to add cooling.

⁴²² Program tracking data does not provide an EER2 value. These are estimated based on the other values in the table.

⁴²³ ENERGY STAR minimum.

⁴²⁴ Based on analysis of metering results from 24 heat pumps in Ameren Illinois service territory in PY5 coincident with AIC’s 2010 system peak; ‘Impact and Process Evaluation of Ameren Illinois Company’s Residential HVAC Program (PY5)’.

⁴²⁵ Based on analysis of Itron eShape data for Missouri, calibrated to Illinois loads, supplied by Ameren. The average AC load over the PJM peak period (1-5pm, M-F, June through August) is divided by the maximum AC load during the year.

⁴²⁶ All-Electric Homes PY6 Metering Results: Multifamily HVAC Systems, Cadmus, October 2015

residential sized systems serving 2 or more units, assume single family. For central systems use Volume 2 Commercial and Industrial Measures.

Time of Sale:

For example, a three ton, 15.2 SEER2, 12.4 EER2, 9 HSPF2 Air Source Heat Pump installed in single-family home in Marion with Quality Installation:

$$\begin{aligned}\Delta kW_{SSP} &= (36,000/1 * (1/(9.4 * (1-0.1)) - 1/(12.4 * (1-0)))) / 1000 * 0.72 \\ &= 0.9735 \text{ kW}\end{aligned}$$

$$\begin{aligned}\Delta kW_{PJM} &= (36,000/1 * (1/(9.4 * (1-0.1)) - 1/(12.4 * (1-0)))) / 1000 * 0.466 \\ &= 0.6301 \text{ kW}\end{aligned}$$

Early Replacement:

For example, a 3-ton, 15.2 SEER2, 12.4 EER2, 9 HSPF2 Air Source Heat Pump replaces an existing working Air Source Heat Pump with unknown efficiency ratings in single-family home in Marion with Quality Installation:

$$\begin{aligned}\Delta kW_{SSP} \text{ for remaining life of existing unit (1st 6 years):} \\ &= (36,000/1 * (1/(7.5 * (1-0.1)) - 1/(12.4 * (1-0)))) / 1000 * 0.72 \\ &= 1.68 \text{ kW}\end{aligned}$$

$$\begin{aligned}\Delta kW_{SSP} \text{ for remaining measure life (next 10 years):} \\ &= (36,000/1 * (1/(9.4 * (1-0.1)) - 1/(12.4 * (1-0)))) / 1000 * 0.72 \\ &= 0.9735 \text{ kW}\end{aligned}$$

$$\begin{aligned}\Delta kW_{PJM} \text{ for remaining life of existing unit (1st 6 years):} \\ &= (36,000/1 * (1/(7.5 * (1-0.1)) - 1/(12.4 * (1-0)))) / 1000 * 0.466 \\ &= 1.087 \text{ kW}\end{aligned}$$

$$\begin{aligned}\Delta kW_{PJM} \text{ for remaining measure life (next 10 years):} \\ &= (36,000/1 * (1/(9.4 * (1-0.1)) - 1/(12.4 * (1-0)))) / 1000 * 0.466 \\ &= 0.6301 \text{ kW}\end{aligned}$$

FOSSIL FUEL SAVINGS

Calculation provided together with Electric Energy Savings above.

WATER IMPACT DESCRIPTIONS AND CALCULATION

N/A

DEEMED O&M COST ADJUSTMENT CALCULATION

N/A

COST EFFECTIVENESS SCREENING AND LOAD REDUCTION FORECASTING WHEN FUEL SWITCHING

This measure can involve fuel switching from fossil fuel to electric.

For the purposes of forecasting load reductions due to fuel switch ASHP projects per Section 16-111.5B, changes in site energy use at the customer’s meter (using ΔkWh algorithm below), customer switching estimates, NTG, and any other adjustment factors deemed appropriate, should be used.

The inputs to cost effectiveness screening should reflect the actual impacts on the electric and fuel consumption at the customer meter and, for fuel switching measures, should therefore reflect the decrease in one fuel and increase in another, as opposed to the single savings value calculated in the “Electric and Fossil Fuel Energy Savings” section above. Therefore in addition to the calculation of savings claimed, the following values should be used to assess the

cost effectiveness of the measure. For Early Replacement measures, the efficiency and Fe terms of the existing unit should be used for the remaining useful life of the existing equipment (6 years for ASHP and Central AC, 7 years for furnace, 8 years for boilers or GSHP, 16 years for electric resistance), and the efficiency and Fe terms for a new baseline unit should be used for the remaining years of the measure.

$$\begin{aligned}\Delta\text{Therms} &= [\text{Heating Consumption Replaced}] \\ &= [(\% \text{FuelSwitch} * \text{HeatLoad_Disp} / \text{DuctlessSave} * 1 / \text{AFUE}_{\text{base}}) / 100,000] \\ \Delta\text{kWh} &= [\text{FurnaceFanSavings}] - [\text{ASHP heating consumption}] + [\text{Cooling savings}] \\ &= \% \text{FuelSwitch} * [[\text{FurnaceFlag} * \text{HeatLoad_Disp} / \text{DuctlessSave} * 1 / \text{AFUE}_{\text{base}} * F_e * \\ &0.000293] - [(\text{HeatLoad_Disp} * (1 / (\text{HSPF2_ee} * \text{HSPF2_ClimateAdj} * \text{PD_Adj} * (1 - \\ \text{DeratingHeat}_{\text{Eff}})))) / 1000] + [((\text{CoolingLoad} / \text{DuctlessSave} * (1 / (\text{SEER2_base} * (1 - \\ \text{DeratingCool}_{\text{Base}})))) - ((\text{CoolingLoad} * 1 / (\text{SEER2_ee} * (1 - \text{DeratingCool}_{\text{Eff}})))) / 1000]\end{aligned}$$

MEASURE CODE: RS-HVC-ASHP-V15-250101

REVIEW DEADLINE: 1/1/2028

5.3.2 Boiler Pipe Insulation

DESCRIPTION

This measure describes adding insulation to un-insulated boiler pipes in un-conditioned basements or crawlspaces.

This measure was developed to be applicable to the following program types: TOS, RNC, RF, DI.

If applied to other program types, the measure savings should be verified.

DEFINITION OF EFFICIENT EQUIPMENT

The efficient case is installing pipe wrap insulation to a length of boiler pipe.

DEFINITION OF BASELINE EQUIPMENT

The baseline is an un-insulated boiler pipe.

DEEMED LIFETIME OF EFFICIENT EQUIPMENT

The measure life is assumed to be 11 years.⁴²⁷

Note a mid-life adjustment to account for replacement of HVAC equipment during the measure life should be applied after 9 years.⁴²⁸ See section below for detail.

DEEMED MEASURE COST

The actual installation cost should be used if known. If unknown, the measure cost including material and installation is assumed to be \$3 per linear foot.⁴²⁹ For foam pipe insulation assume a measure cost of \$0.56/ft for ½” insulation and \$0.90/ft for ¾” insulation.⁴³⁰

LOADSHAPE

N/A

COINCIDENCE FACTOR

N/A

Algorithm

CALCULATION OF SAVINGS

ELECTRIC ENERGY SAVINGS

N/A

SUMMER COINCIDENT PEAK DEMAND SAVINGS

N/A

FOSSIL FUEL SAVINGS

$$\Delta\text{Therm} = (((1/R_{\text{exist}} - 1/R_{\text{new}}) * C_{\text{inside}} * L_{\text{effective}} * \text{FLH}_{\text{heat}} * \Delta T) / \eta_{\text{Boiler}}) / 100,000$$

⁴²⁷ DEER 2014

⁴²⁸ This is intentionally longer than the assumptions found in the early replacement measures as the application of this measure will occur in a variety of homes that will not be targeted for early replacement HVAC systems.

⁴²⁹ Consistent with DEER 2008 Database Technology and Measure Cost Data.

⁴³⁰ Review of website cost data for Homedepot.com, Lowes.com, and Menards.com for locations in Peoria, IL. Websites accessed 5/6/24.

Where:

- R_{exist} = Pipe heat loss coefficient of uninsulated pipe (existing) [(hr-°F-ft²)/Btu]
= Varies based on pipe size and material. See table below for values.
- R_{new} = Pipe heat loss coefficient of insulated pipe (new) [(hr-°F-ft²)/Btu]
= Actual (R_{exist} + R value of insulation⁴³¹)
- C_{inside} = Inside circumference of the pipe [ft]
= Actual (0.5" pipe = 0.1427 ft, 0.75" pipe = 0.2055 ft); See table below for values.
- $L_{effective}$ = Effective Length of pipe from boiler covered by pipe insulation (ft)⁴³²
= $L_{Horizontal} + \alpha L_{Vertical}$
= Actual; See table below for α values. If unknown, assume 3ft of vertical and remaining horizontal.
- FLH_{heat} = Full load hours of heating
= Dependent on location:⁴³³

Climate Zone (City based upon)	FLH _{heat}
1 (Rockford)	1924
2 (Chicago)	1726
3 (Springfield)	1708
4 (Belleville)	1195
5 (Marion)	1270
Weighted Average ⁴³⁴	
ComEd	1766
Ameren	1543
Statewide	1700

- ΔT = Average temperature difference between circulated heated water and unconditioned space air temperature (°F)⁴³⁵

⁴³¹ Where possible it should be ensured that the R-value of the insulation is at the appropriate mean rating temperature (125F).

⁴³² In cases with zero wind, heat loss (and therefore) savings is larger from horizontal pipe configurations than vertical pipe configurations due, perhaps to the way in which convective losses are handled. An analysis of the 3E PLUS tool by NAIMA (<https://insulationinstitute.org/tools-resources/free-3e-plus/>) yielded adjustment factors for horizontal to vertical loss and savings values. See DHW_PipeInsulationCalcs_062121.xlsx for details of the analysis and comparisons.

⁴³³ Full load heating hours for heat pumps are provided for Rockford, Chicago and Springfield in the ENERGY STAR Calculator. Estimates for the other locations were calculated based on the FLH to Heating Degree Day (from NCDC) ratio. VEIC consider ENERGY STAR estimates to be high due to oversizing not being adequately addressed. Using average Illinois billing data (from Illinois Commerce Commission) VEIC estimated the average gas heating load and used this to estimate the average home heating output (using 83% average gas heat efficiency). Dividing this by a typical 36,000 Btu/hr ASHP gives an estimate of average ASHP FLH_{heat} of 1821 hours. We used the ratio of this value to the average of the locations using the ENERGY STAR data (1994 hours) to scale down the ENERGY STAR estimates. There is a county mapping table in Volume 1, Section 3.7 providing the appropriate city to use for each county of Illinois. During update cycle for version v.12, applied percent change of HDD60, NCEI Annual Normals from 30 yr data set (1981-2010) to more recent 15 yr data (2006-2020) to all FLH_{heat} values

⁴³⁴ Weighting for Ameren is based on electric heat accounts in each of the heating zones. Weighting for ComEd and Statewide average is based on number of occupied residential housing units in each zone. ComEd is weighted average of Zones 1-2. Alternative program-weighted assumptions can be used if appropriate.

⁴³⁵ Assumes 160°F water temp for a boiler without reset control, 120°F for a boiler with reset control, and 50°F air temperature

Pipes in unconditioned basement:

Outdoor reset controls	ΔT (°F)
Boiler without reset control	110
Boiler with reset control	70

Pipes in crawl space:

Climate Zone (City based upon)	ΔT (°F)	
	Boiler without reset control	Boiler with reset control
1 (Rockford)	127	87
2 (Chicago)	126	86
3 (Springfield)	122	82
4 (Belleville)	120	80
5 (Marion)	120	80
Weighted Average ⁴³⁶	125	85

η_{Boiler} = Efficiency of boiler
= 0.819⁴³⁷

Parameter assumptions for various pipe sizes and materials:

Type and Size	C _{Inside} ⁴³⁸ (I.D.*π/12) (ft)	Product of Overall Heat Transfer Coefficient and Pipe Area (UA) per foot ⁴³⁹ from bare pipe (BTU/hr·ft·°F)	Pipe Area per linear foot (ft ²) ⁴⁴⁰	R _{exist} ((hr·ft·°F)/BTU)	Horizontal to Vertical Adjustment Factor (α)
½" Copper Pipe	0.1427	0.345	0.153	0.444	0.67
¾" Copper Pipe	0.2055	0.417	0.217	0.521	0.72
½" PEX	0.1270	0.438	0.145	0.332	0.73
¾" PEX	0.1783	0.545	0.204	0.374	0.77

For example, insulating 10 feet of 0.75" copper pipe (4ft vertical and 6 ft horizontal) with R-3 insulation in a crawl space of a Marion home with a boiler without reset control:

$$\Delta_{Therm} = (((1/0.521 - 1/3.521) * 0.2055 * (6 + 4*0.72) * 110 * 1270) / 0.819) / 100,067$$

$$= 5.09 \text{ therms}$$

Mid-Life adjustment

for pipes in unconditioned basements and the following average heating season outdoor temperatures as the air temperature in crawl spaces: Zone 1 – 33.1, Zone 2 – 34.4, Zone 3 – 37.7, Zone 4 – 40.0, Zone 5 – 39.8, Weighted Average – 35.3 (NCDC 1881-2010 Normals, average of monthly averages Nov – Apr for zones 1-3 and Nov-March for zones 4 and 5).

⁴³⁶ Weighted based on number of occupied residential housing units in each zone.

⁴³⁷ Average efficiency of boiler units found in Ameren PY3-PY4 data.

⁴³⁸ See: <https://energy-models.com/pipe-sizing-charts-tables> (last accessed 5/7/21) for copper pipe sizes and <https://www.garagesanctum.com/size-chart/pex-tubing-size-chart/> (last accessed 5/7/21) for PEX pipe sizes.

⁴³⁹ Laboratory measured values from Hoeschele and Weitzel (2012), Figure 1.

⁴⁴⁰ Calculated using the average pipe thickness (I.D. + O.D.)*0.5.

In order to account for the likely replacement of existing heating equipment during the lifetime of this measure, a mid-life adjustment should be applied. To calculate the adjustment, re-calculate the savings above using the following new baseline system efficiency assumptions:

Efficiency Assumption	System Type	New Baseline Efficiency
η_{Heat}	Boiler	84% AFUE

This reduced annual savings should be applied following the assumed remaining useful life of the existing equipment, estimate to be 13 years.⁴⁴¹ Note if the existing equipment efficiency is greater than the new baseline efficiency listed above, do not apply a mid-life adjustment.

WATER IMPACT DESCRIPTIONS AND CALCULATION

N/A

DEEMED O&M COST ADJUSTMENT CALCULATION

N/A

MEASURE CODE: RS-HVC-PINS-V08-250101

REVIEW DEADLINE: 1/1/2027

⁴⁴¹ This is intentionally longer than the assumption found in the early replacement measures as the application of this measure will occur in a variety of homes and will not be targeting those homes appropriate for early replacement HVAC systems.

5.3.3 Central Air Conditioning

DESCRIPTION

This measure characterizes:

- a) Time of Sale:
 - a. The installation of a new residential sized ($\leq 65,000$ Btu/hr) Central Air Conditioning ducted split system meeting specifications determined by the program. This could relate to the replacement of an existing unit at the end of its useful life, or the installation of a new system in a new home.
- b) Early Replacement:

Early Replacement determination will be based on meeting the following conditions:

- The existing unit is operational when replaced, or
- The existing unit requires minor repairs ($< \$190$ per ton).⁴⁴²
- All other conditions will be considered Time of Sale.

The Baseline SEER2 of the existing Central Air Conditioning unit replaced:

- If the SEER of the existing unit is known use the actual SEER (converted to SEER2) value of the unit replaced.
- If the SEER of the existing unit is unknown, use assumptions in variable list below (SEER2_exist).
- If the operational status or repair cost of the existing unit is unknown, use time of sale assumptions.

A weighted average early replacement rate is provided when the actual baseline early replacement rate is unknown.⁴⁴³

Deemed Early Replacement Rates for CAC Units in Combined System Replacement (CSR) Projects

Replacement Scenario for the CAC Unit	Deemed Early Replacement Rate
Early Replacement Rate for participants when a CAC unit when the CAC unit is the Primary unit in a CSR project	14%
Early Replacement Rate for participants when a CAC unit when the CAC unit is the Secondary unit in a CSR project	40%

Note: it is not appropriate to claim additional ECM fan savings (from 5.3.5 Furnace Blower Motor) due to installing new CAC units with an ECM, since the SEER2/EER2 ratings already account for this electrical load.

Quality Installation:

Additional savings are attributed to the Quality Installation (QI) of the system. QI programs should follow industry standards such as those described in ENERGY STAR Verified HVAC Installation Program (ESVI), ANSI ACCA QI5 and QI9vp. This must include considerations of system design (including sizing, matching, ventilation calculations) and

⁴⁴² The Technical Advisory Committee agreed that if the cost of repair is less than 20% of the new baseline replacement cost it can be considered early replacement. Note the non-inflated cost is used as this would be a cost consideration in the program year.

⁴⁴³ Based upon research from “Home Energy Efficiency Rebate Program GPY2 Evaluation Report” which outlines early replacement rates for both primary and secondary central air cooling (CAC) and residential furnaces. The unit (furnace or CAC unit) that initially caused the customer to contact a trade ally is defined as the “primary unit”. The furnace or CAC unit that was also replaced but did not initially prompt the customer to contact a trade ally is defined as the “secondary unit”. This evaluation used different criteria for early replacement due to the availability of data after the fact; cost of any repairs $< \$550$ and age of unit < 20 years. Report presented to Nicor Gas Company February 27, 2014.

equipment installation (including static pressure, airflow, refrigerant charge) and may also consider distribution.

This measure was developed to be applicable to the following program types: TOS, NC, EREP. If applied to other program types, the measure savings should be verified.

DEFINITION OF EFFICIENT EQUIPMENT

In order for this characterization to apply, the efficient equipment is assumed to be a ducted split central air conditioning unit meeting specifications determined by the program. For reference, the minimum ENERGY STAR version 6.1 efficiency level standards are provided below⁴⁴⁴:

- Split system central air conditioners – 15.2 SEER2 and 12.0 EER2
- Single package central air conditioners – 15.2 SEER2 and 11.5 EER2
- Space constrained units – 13.4 SEER2⁴⁴⁵

The measure characterization recommends sourcing the efficiency specifications from the actually installed equipment. If those values are not known, the default equipment efficiency recommendations are conservatively based on ENERGY STAR version 6.1 specifications.

The following conversion factors are recommended for use if the efficient equipment is not rated under the new testing procedure:⁴⁴⁶

$$\text{SEER2} = \text{SEER} * X$$

$$\text{EER2} = \text{EER} * X$$

Where:

X	SEER	EER
Ducted	0.95	0.95
Packaged	0.95	0.95

DEFINITION OF BASELINE EQUIPMENT

The baseline for the Time of Sale measure is based on the current Federal Standard efficiency level⁴⁴⁷:

- Standard sized Split system air conditioners – 13.4 SEER2

⁴⁴⁴ ENERGY STAR Program Requirements Product Specification for Central Air Conditioner and Heat Pump Equipment, v6.1, effective January 1, 2023, are in terms of an updated metric, depicted as SEER2 and EER2. The updated test method as well as the updated ENERGY STAR specifications mimic the updated federal appliance standards. An equivalent stringency of these new standards for split system air conditioners are 16 SEER and 13 EER and for single-package air conditioners are 16 SEER and EER 12, as detailed in: Consortium for Energy Efficiency (CEE) Residential HVAC Specifications, Estimated Appendix M1 Equivalents, January 15 2021

⁴⁴⁵ The ENERGY STAR specification does not provide an efficiency level for space constrained products but this is a proposed level for this product type that the marketplace has developed solutions to meet.

⁴⁴⁶ Consortium for Energy Efficiency (CEE), Testing, Testing, M1, 2, 3, Transitioning to New Federal Minimum Standards, CEE Summer Program Meeting, June 10, 2022.

⁴⁴⁷ The 2023 federal standards (10 CFR 430.32(c)(5)) are in terms of an updated metric, depicted as SEER2 and manufacturers must certify their products meet the standard according to the new test procedure and new metrics. The updated test method as well as the updated energy conservation standards were negotiated under the appliance standards and rulemaking federal advisory committee (ASRAC) in accordance with the Federal Advisory Committee Act (FACA) and the negotiated rulemaking act. An equivalent stringency of these new standards for split system air conditioners are 14 SEER and for single-package air conditioners are 14 SEER, as detailed in: Federal Code of Regulations, Energy Conservation Program: Energy Conservation Standards for residential Central Air Conditioners and Heat Pumps; Confirmation of effective date and compliance date for direct final rule, May 26, 2017, Docket: EERE-2014-BT-STD-0048 (<https://www.regulations.gov/document/EERE-2014-BT-STD-0048-0200>)

- Standard sized Single-package air conditioners – 13.4 SEER2
- Space constrained air conditioners – 11.7 SEER2
- Room AC for mobile homes – 7.7 EER

Note, the space constrained product baseline should only be used when the efficient unit is classified as space constrained. It is assumed that ‘Quality Installation’ did not occur.

For mobile homes, replacing central AC presents a series of challenges, not least due to structural limitations. It is assumed that in the absence of program support, units would not be replaced with a new central AC unit but instead be replaced with multiple room AC units.

The baseline for the early replacement measure is the efficiency of the existing equipment for the assumed remaining useful life of the unit and the new baseline as defined above for the remainder of the measure life.⁴⁴⁸ Consistent with TRM Volume 1 Section 2.3.1 for midstream programs or other cases where the existing condition is unknown, it may be appropriate to apply a deemed percent split of Time of Sale and Early Replacement assumptions based on evaluation results

DEEMED LIFETIME OF EFFICIENT EQUIPMENT

The expected measure life is assumed to be 18 years.⁴⁴⁹

Remaining life of existing equipment is assumed to be 6 years.⁴⁵⁰

DEEMED MEASURE COST

Time of sale (non-mobile homes): The incremental capital cost for this measure is dependent on efficiency. Assumed incremental costs are provided below:⁴⁵¹

Efficiency Level (SEER2)	Incremental Cost
13.4	\$0
15.2	\$1070
16.2	\$1270

Time of sale (mobile homes):

For mobile homes, this measure assumes a baseline of three 8,500 BTU/hr room AC units purchased via the secondary market and assumed to cost \$50 each – for a total of \$150. This should be compared to a typical retail cost for an ENERGY STAR 3-ton unit of \$3,750⁴⁵² for an incremental cost estimate of \$3,600.

An additional \$150 every 6 years should be included to account for the replacement of the secondhand room AC units.

Early replacement: The full install cost for this measure is the actual cost of removing the existing unit and installing the new one. If this is unknown, assume defaults below.⁴⁵³

⁴⁴⁸ Baseline SEER and EER should be updated when new minimum federal standards become effective.

⁴⁴⁹ Measure Life Report, Residential and Commercial/Industrial Lighting and HVAC Measures, GDS Associates, June 2007.

⁴⁵⁰ Assumed to be one third of effective useful life.

⁴⁵¹ Based on EIS report “Updated Buildings Sector Appliance and Equipment Costs and Efficiencies”, March 2023.

⁴⁵² Ibid.

⁴⁵³ Based on 3 ton initial cost estimate for a conventional unit from ENERGY STAR Central AC calculator, \$2,857. Efficiency cost increment consistent with Cadmus study results.

Efficiency Level (SEER2)	Full Retrofit Cost (including labor)
15.2	\$952 / ton + \$1,070
16.2	\$952 / ton + \$1,270

Assumed deferred cost (after 6 years) of replacing existing equipment with new baseline unit is assumed to be \$3,140⁴⁵⁴ for non-mobile homes and \$150 for mobile homes. This cost should be discounted to present value using the nominal societal discount rate.

Quality Installation: The additional design and installation work associated with quality installation has been estimated to cost an additional \$150.⁴⁵⁵

LOADSHAPE

Loadshape R08 - Residential Cooling

COINCIDENCE FACTOR

The summer peak coincidence factor for cooling is provided in two different ways below. The first is used to estimate peak savings during the utility peak hour and is most indicative of actual peak benefits, and the second represents the *average* savings over the defined summer peak period and is presented so that savings can be bid into PJM’s capacity market.

CF_{SSP} = Summer System Peak Coincidence Factor for Central A/C (during system peak hour)
 = 68%⁴⁵⁶

CF_{PJM} = PJM Summer Peak Coincidence Factor for Central A/C (average during PJM peak period)
 = 46.6%⁴⁵⁷

Algorithm

CALCULATION OF SAVINGS

ELECTRIC ENERGY SAVINGS

Time of sale (non-mobile homes):

$$\Delta \text{kWh} = (\text{FLHcool} * \text{Capacity} * (1/(\text{SEER2base} * (1 - \text{DeratingCool}_{\text{Base}})) - 1/(\text{SEER2ee} (1 - \text{DeratingCool}_{\text{Eff}}))))/1000$$

Time of sale (mobile homes):

$$\Delta \text{kWh} = \text{kWhBaseRAC} - \text{kWhEffCAC}$$

$$\text{kWhBaseRAC} = (\#\text{RACUnits} * \text{FLHcool} * \text{CapacityRAC} * (1/(\text{EERbase}/1.01)))/1,000$$

$$\text{kWhEffCAC} = (\text{FLHcool} * \text{Capacity} * (1/(\text{SEER2ee} (1 - \text{DeratingCool}_{\text{Eff}}))))/1,000$$

⁴⁵⁴ Based on 3 ton initial cost estimate for a conventional unit from ENERGY STAR Central AC calculator, \$2,857, and applying inflation rate of 1.91%. While baselines are likely to shift in the future, there is currently no good indication of what the cost of a new baseline unit will be in 6 years. In the absence of this information, assuming a constant federal baseline cost is within the range of error for this prescriptive measure.

⁴⁵⁵ Based on data provided by MidAmerican in April 2018 summarizing survey results from 11 HVAC suppliers in Iowa.

⁴⁵⁶ Based on metering of 24 homes with central AC during PY4 and PY5 in Ameren Illinois service territory.

⁴⁵⁷ Based on analysis of Itron eShape data for Missouri, calibrated to Illinois loads, supplied by Ameren. The average AC load over the PJM peak period (1-5pm, M-F, June through August) is divided by the maximum AC load during the year.

Early replacement:⁴⁵⁸

ΔkWh for remaining life of existing unit (1st 6 years):

$$= (\text{FLHcool} * \text{Capacity} * (1 / (\text{SEER2exist} * (1 - \text{DeratingCool}_{\text{Base}})) - 1 / (\text{SEER2ee} * (1 - \text{DeratingCool}_{\text{Eff}})))) / 1,000$$

ΔkWh for remaining measure life (next 12 years) – non mobile-homes:

$$= (\text{FLHcool} * \text{Capacity} * (1 / (\text{SEER2base} * (1 - \text{DeratingCool}_{\text{Base}})) - 1 / (\text{SEER2ee} * (1 - \text{DeratingCool}_{\text{Eff}})))) / 1,000$$

ΔkWh for remaining measure life (next 12 years) – mobile-homes:

$$= \text{kWhBaseRAC} - \text{kWhEffCAC}$$

$$\text{kWhBaseRAC} = (\# \text{RACUnits} * \text{FLHcool} * \text{CapacityRAC} * (1 / (\text{EERbase} / 1.01))) / 1,000$$

$$\text{kWhEffCAC} = (\text{FLHcool} * \text{Capacity} * (1 / (\text{SEER2ee} * (1 - \text{DeratingCool}_{\text{Eff}})))) / 1,000$$

Where:

FLHcool = Full load cooling hours

= dependent on location and building type:⁴⁵⁹

Climate Zone (City based upon)	FLHcool (single family)	FLHcool (multifamily)	FLH_cooling (weatherized multifamily) ⁴⁶⁰
1 (Rockford)	547	499	320
2 (Chicago)	709	629	403
3 (Springfield)	779	707	453
4 (Belleville)	1,082	982	630
5 (Marion)	956	868	557
Weighted Average ⁴⁶¹			
ComEd	676	603	386
Ameren	875	791	507
Statewide	731	655	420

Use Multifamily if the Building meets the utility’s definition for multifamily and system serves single unit. For residential sized systems serving 2 or more units, assume single family hours. For central systems use Volume 2 Commercial and Industrial Measures.

⁴⁵⁸ The two equations are provided to show how savings are determined during the initial phase of the measure (existing to efficient) and the remaining phase (new baseline to efficient). In practice, the screening tools used may either require a First Year savings (using the first equation) and then a “number of years to adjustment” and “savings adjustment” input which would be the (new base to efficient savings)/(existing to efficient savings).

⁴⁵⁹ Full load hours for Chicago, Moline and Rockford are provided in “Final Evaluation Report: Central Air Conditioning Efficiency Services (CACES), 2010, Navigant Consulting”, p.33. An average FLH/Cooling Degree Day (from NCDC) ratio was calculated for these locations and applied to the CDD of the other locations in order to estimate FLH. There is a county mapping table in Volume 1, Section 3.7 providing the appropriate city to use for each county of Illinois.

⁴⁶⁰ All-Electric Homes PY6 Metering Results: Multifamily HVAC Systems, Cadmus, October 2015. The multifamily units within this study had undergone significant shell improvements (air sealing and insulation) and therefore this set of assumptions is only appropriate for units that have recently participated in a weatherization or other shell program. Note that the FLHcool where recalculated based on existing efficiencies consistent with the TRM rather than from the metering study. During update cycle for version v.12, applied percent change of CDD65, NCEI Annual Normals from 30 yr data set (1981-2010) to more recent 15 yr data (2006-2020) to all FLHcool values.

⁴⁶¹ Weighting for Ameren is based on electric accounts in each of the cooling zones. Weighting for ComEd and Statewide average is based on number of occupied residential housing units in each zone. ComEd is weighted average of Zones 1-2. Alternative program-weighted assumptions can be used if appropriate.

Capacity	= Size of new equipment in Btu/hr (note 1 ton = 12,000Btu/hr) = Use actual when program delivery allows size of AC unit to be known. If unknown, assume 33,600 Btu/hr for single family homes, 28,000 Btu/hr for multifamily, or 24,000 Btu/hr for mobile homes. ⁴⁶² If building type is unknown, assume 31,864Btu/hr. ⁴⁶³
SEER2base	= Seasonal Energy Efficiency Ratio of baseline unit (kBtu/kWh) = 13.4 SEER2 for standard sized units or 11.7 SEER2 for space constrained units ⁴⁶⁴
SEER2exist	= Seasonal Energy Efficiency Ratio 2 of existing unit (kBtu/kWh) = Use actual SEER2 rating where it is possible to measure or reasonably estimate. If using rated efficiencies, derate efficiency value by 1% per year (maximum of 30 years) to account for degradation over time, ⁴⁶⁵ or, if unknown, assume 9.2 SEER2. ⁴⁶⁶ If unknown value is used, it should not be derated by age.
SEER2ee	= Rated Seasonal Energy Efficiency Ratio 2 of ENERGY STAR unit (kBtu/kWh) = Actual, or 15.2 SEER2 (15.9 SEER) if unknown.
DeratingCool _{Eff}	= Efficient Central Air Conditioner Cooling derating = 0% if Quality Installation is performed = 10% if Quality Installation is not performed or unknown ⁴⁶⁷
DeratingCool _{Base}	= Baseline Central Air Conditioner Cooling derating = 10%
#RACUnits	= Number of Room AC units assumed to have been installed in mobile home instead of a replacement CAC unit = Actual, if unknown assume 3
CapacityRAC	= Capacity of assumed Room AC unit = Actual, if unknown assume 8500 Btu/hr ⁴⁶⁸
EERbase	= Efficiency of baseline Room AC unit, assumed to be purchased through the secondary market

⁴⁶² Single family cooling capacity based on Final Evaluation Report: Central Air Conditioning Efficiency Services (CACES), October 19, 2010, ComEd, Navigant Consulting. Multifamily capacity based on weighted average of PY9 Ameren and ComEd MF cooling capacities. Mobile home capacity based on ENERGY STAR’s Manufactured Home Cooling Equipment Sizing Guidelines which vary by climate zone and home size. The average size of a mobile home in the East North Central region (1,120 square feet) from the 2015 RECS data is used to calculate appropriate size.

⁴⁶³ Unknown is based on statewide weighted average of 69% single family and 31% multifamily, based on IL data from 2009 RECS Table HC2.9 Structural and Geographic Characteristics of Homes in Midwest Region, Divisions and States, 2009.

⁴⁶⁴ Based on Minimum Federal Standard.

⁴⁶⁵ Justification for degradation factors can be found on page 14 of ‘AIC HVAC Metering Study Memo FINAL 2_28_2018’. Estimate efficiency as (Rated Efficiency * (1-0.01)^{Equipment Age}).

⁴⁶⁶ Based on Opinion Dynamics and Cadmus metering study of Ameren HVAC program participants, assumption provided for 2020; See ‘AIC HVAC Metering Study Memo FINAL 2_28_2018’ Converted to SEER2.

⁴⁶⁷ Based on Cadmus assumption provided in preparation of the 2014 Interstate Power and Light TRM based upon proper refrigerant charge, evaporator airflow, and unit sizing, Appears conservative in comparison to ENERGY STAR statements (see ‘Sponsoring an ENERGY STAR Verified HVAC Installation (ESVI) Program’).

⁴⁶⁸ Based on maximum capacity average from the RLW Report: Final Report Coincidence Factor Study Residential Room Air Conditioners, June 23, 2008

= Actual, if unknown assume 7.7⁴⁶⁹

1.01 = Factor to convert EER to CEER (CEER includes standby and off power consumption)⁴⁷⁰

Time of sale non mobile-home example: a 3 ton unit with SEER2 rating of 17, EER2 rating of 12.5 in unknown location without Quality Install:

$$\begin{aligned} \Delta\text{kWh} &= (731 * 36,000 * (1/(13.4 * (1-0.1)) - 1 / (17 * (1-0.1)))) / 1,000 \\ &= 462 \text{ kWh} \end{aligned}$$

Time of sale example: a 3-ton unit with SEER2 rating of 17, EER2 rating of 12.5 in unknown location with Quality Install:

$$\begin{aligned} \Delta\text{kWh} &= (731 * 36,000 * (1/(13.4 * (1-0.1)) - 1 / (17 * (1-0)))) / 1,000 \\ &= 634 \text{ kWh} \end{aligned}$$

Time of sale mobile-home example: a 3-ton unit with SEER2 rating of 17, EER2 rating of 12.5 is installed with Quality Install in a mobile home in Belleville, in place of 3 Room AC units:

$$\begin{aligned} \Delta\text{kWh} &= \text{kWhBaseRAC} - \text{kWhEffCAC} \\ \text{kWhBaseRAC} &= (3 * 1,082 * 8,500 * (1/(7.7/1.01)))/1,000 \\ &= 3,619 \text{ kWh} \\ \text{kWhEffCAC} &= (1,082 * 36,000 * (1/(17 * (1 - 0))))/1,000 \\ &= 2,291 \text{ kWh} \\ \Delta\text{kWh} &= 3,619 - 2,291 \\ &= 1,328 \text{ kWh} \end{aligned}$$

Early replacement example: a 3-ton unit, with SEER2 rating of 17, EER2 rating of 12.5 replaces an existing unit in unknown location with quality installation:

$$\begin{aligned} \Delta\text{kWh}(\text{for first 6 years}) &= (731 * 36,000 * (1/(9.2 * (1-0.1)) - 1/(17 * (1-0))))/1,000 \\ &= 1,630 \text{ kWh} \\ \Delta\text{kWh}(\text{for next 12 years}) &= (731 * 36,000 * (1/(13.4 * (1-0.1)) - 1/(17 * (1-0))))/1,000 \\ &= 634 \text{ kWh} \end{aligned}$$

Therefore, savings adjustment of 39% (634/1,630) after 6 years.

SUMMER COINCIDENT PEAK DEMAND SAVINGS

Time of sale (non mobile-homes):

$$\Delta\text{kW} = (\text{Capacity} * (1/(\text{EER2base} * (1 - \text{DeratingCool}_{\text{Base}})) - 1/(\text{EER2ee} * (1 - \text{DeratingCool}_{\text{Eff}}))))/1,000 * \text{CF}$$

⁴⁶⁹ Based on Nexus Market Research Inc, RLW Analytics, December 2005; "Impact, Process, and Market Study of the Connecticut Appliance Retirement Program: Overall Report."

⁴⁷⁰ Version 3.0 of the ENERGY STAR specification provided equivalent EER and CEER ratings and for the most popular size band the EER rating is approximately 1% higher than the CEER. See 'ENERGY STAR Version 3.0 Room Air Conditioners Program Requirements'.

Time of sale (mobile-homes):

$$\begin{aligned} \Delta kW &= (kW_{BaseRAC} - kW_{EffCAC}) * CF \\ kW_{BaseRAC} &= (\#RACUnits * Capacity_{RAC} * (1/(EER_{base}/1.01)))/1,000 \\ kW_{EffCAC} &= (Capacity * (1/(EER_{2ee} (1 - DeratingCool_{Eff}))))/1,000 \end{aligned}$$

Early replacement:⁴⁷¹

$$\begin{aligned} \Delta kW \text{ for remaining life of existing unit (1st 6 years):} \\ &= (Capacity * (1/(EER_{2exist} * (1 - DeratingCool_{Base})) - 1/(EER_{2ee} * (1 - DeratingCool_{Eff}))))/1,000 * CF \end{aligned}$$

$$\begin{aligned} \Delta kW \text{ for remaining measure life (next 12 years) – non mobile-homes:} \\ &= (Capacity * (1/(EER_{2base} * (1 - DeratingCool_{Base})) - 1/(EER_{2ee} * (1 - DeratingCool_{Eff}))))/1,000 * CF \end{aligned}$$

$$\begin{aligned} \Delta kW \text{ for remaining measure life (next 12 years) –mobile-homes:} \\ &= (kW_{BaseRAC} - kW_{EffCAC}) * CF \\ kW_{BaseRAC} &= (\#RACUnits * Capacity_{RAC} * (1/(EER_{base}/1.01)))/1,000 \\ kW_{EffCAC} &= (Capacity * (1/(EER_{2ee} (1 - DeratingCool_{Eff}))))/1,000 \end{aligned}$$

Where:

EER _{2base}	= EER2 Efficiency of baseline unit = 10.6 EER2 for standard sized units ⁴⁷² = 9.2 EER2 for space constrained units
EER _{2exist}	= EER2 Efficiency of existing unit = Use actual EER2 rating where it is possible to measure or reasonably estimate. If using rated efficiencies, derate efficiency value by 1% per year (maximum of 30 years) to account for degradation over time. ⁴⁷³ If unknown, assume 7.4 EER2. ⁴⁷⁴ If unknown value is used, it should not be derated by age.
EER _{2ee}	= EER2 Efficiency of ENERGY STAR unit = Actual installed or 12.4 EER2 if unknown
CF _{SSP}	= Summer System Peak Coincidence Factor for Central A/C (during system peak hour) = 68% ⁴⁷⁵

⁴⁷¹ The two equations are provided to show how savings are determined during the initial phase of the measure (existing to efficient) and the remaining phase (new baseline to efficient). In practice, the screening tools used may either require a First Year savings (using the first equation) and then a “number of years to adjustment” and “savings adjustment” input which would be the (new base to efficient savings)/(existing to efficient savings).

⁴⁷² The federal Standard does not currently include an EER2 component. The value provided is based on Opinion Dynamics and Cadmus metering study of Ameren HVAC program participants; See ‘AIC HVAC Metering Study Memo FINAL 2_28_2018’. Converted to EER2.

⁴⁷³ Justification for degradation factors can be found on page 14 of ‘AIC HVAC Metering Study Memo FINAL 2_28_2018’. Estimate efficiency as (Rated Efficiency * (1-0.01)^{Equipment Age}).

⁴⁷⁴ Based on Opinion Dynamics and Cadmus metering study of Ameren HVAC program participants; See ‘AIC HVAC Metering Study Memo FINAL 2_28_2018’. Converted to EER2.

⁴⁷⁵ Based on metering of 24 homes with central AC during PY4 and PY5 in Ameren Illinois service territory.

$$CF_{PJM} = \text{PJM Summer Peak Coincidence Factor for Central A/C (average during peak period)}$$

$$= 46.6\%^{476}$$

Time of sale non mobile-home example: a 3 ton unit with EER2 rating of 12 with Quality Install:

$$\Delta kW_{SSP} = (36,000 * (1/(10.6 * (1-0.1)) - 1/(12 * (1-0)))) / 1,000 * 0.68$$

$$= 0.5260 \text{ kW}$$

$$\Delta kW_{PJM} = (36,000 * (1/(10.6 * (1-0.1)) - 1/(12 * (1-0)))) / 1,000 * 0.466$$

$$= 0.3605 \text{ kW}$$

Time of sale mobile-home example: a 3 ton unit with EER2 rating of 12.5 is installed with Quality Install in a mobile home, in place of 3 Room AC units:

$$\Delta kW = (kW_{BaseRAC} - kW_{EffCAC}) * CF$$

$$kW_{BaseRAC} = (3 * 8,500 * (1/(7.7/1.01)))/1,000$$

$$= 3.3448 \text{ kW}$$

$$kW_{EffCAC} = (36,000 * (1/(12.5 * (1 - 0))))/1,000$$

$$= 2.8800 \text{ kW}$$

$$\Delta kW_{SSP} = (3.3448 - 2.880) * 0.68$$

$$= 0.3161 \text{ kW}$$

$$\Delta kW_{PJM} = (3.3448 - 2.880) * 0.466$$

$$= 0.2166 \text{ kW}$$

Early replacement example: a 3 ton unit with EER2 rating of 12 replaces an existing unit with Quality Install:

$$\Delta kW_{SSP} \text{ (for first 6 years)} = (36,000 * (1/(7.4 * (1-0.1)) - 1/(12 * (1-0)))) / 1,000 * 0.68$$

$$= 1.636 \text{ kW}$$

$$\Delta kW_{SSP} \text{ (for next 12 years)} = (36,000 * (1/(10.1 * (1-0.1)) - 1/(12 * (1-0)))) / 1,000 * 0.68$$

$$= 0.653 \text{ kW}$$

$$\Delta kW_{PJM} \text{ (for first 6 years)} = (36,000 * (1/(7.4 * (1-0.1)) - 1/(12 * (1-0)))) / 1,000 * 0.466$$

$$= 1.121 \text{ kW}$$

$$\Delta kW_{PJM} \text{ (for next 12 years)} = (36,000 * (1/(10.1 * (1-0.1)) - 1/(12 * (1-0)))) / 1,000 * 0.466$$

$$= 0.448 \text{ kW}$$

FOSSIL FUEL SAVINGS

N/A

WATER IMPACT DESCRIPTIONS AND CALCULATION

N/A

⁴⁷⁶ Based on analysis of Itron eShape data for Missouri, calibrated to Illinois loads, supplied by Ameren. The average AC load over the PJM peak period (1-5pm, M-F, June through August) is divided by the maximum AC load during the year.

DEEMED O&M COST ADJUSTMENT CALCULATION

N/A

MEASURE CODE: RS-HVC-CAC1-V13-250101

REVIEW DEADLINE: 1/1/2027

5.3.4 Duct Insulation and Sealing

DESCRIPTION

This measure describes evaluating the savings associated with adding duct insulation or performing duct sealing using mastic sealant, metal tape, or injection of UL certified and low VOC for sealant to the distribution system of homes with either central air conditioning or a ducted heating system.

Three methodologies for estimating the savings associate from sealing the ducts are provided, one of which can also be used to estimate duct insulation savings. The first preferred method requires the use of a blower door, the second method requires a pressurized duct test, and the third requires careful inspection of the duct work.

1. **Modified Blower Door Subtraction** – this technique is described in detail on the Energy Conservatory website. See ‘The Energy Conservatory_Blower-Door-Subtraction-Method.pdf’.
2. **Pressurized Duct Test** – this technique includes direct measurement of air leaks in the duct system.
3. **Evaluation of Distribution Efficiency** – this methodology can be used to estimate duct insulation or duct sealing savings, and requires the evaluation of three duct characteristics below, and use of the Building Performance Institutes ‘Distribution Efficiency Look-Up Table’⁴⁷⁷.
 - a. Percentage of duct work found within the conditioned space
 - b. Duct leakage evaluation
 - c. Duct insulation evaluation

This measure was developed to be applicable to the following program types: RF. If applied to other program types, the measure savings should be verified.

For duct insulation and sealing of central systems in multifamily buildings, use Volume 2 Commercial and Industrial Measures.

DEFINITION OF EFFICIENT EQUIPMENT

For duct sealing, the efficient condition is sealed duct work throughout the unconditioned or semi-conditioned space in the home. A non-conditioned space is defined as a space outside of the thermal envelope of the building that is not intentionally heated for occupancy (crawl space, roof attic, etc.). A semi-conditioned space is defined as a space within the thermal envelop that is not intentionally heated for occupancy (unfinished basement).⁴⁷⁸

For duct insulation, the efficient condition is ductwork insulated with a minimum of R-4 insulation in an unconditioned or semi-conditioned space in the home.

DEFINITION OF BASELINE EQUIPMENT

For duct sealing, the existing baseline condition is leaky duct work within the unconditioned or semi-conditioned space in the home.

For duct insulation, the baseline condition is un-insulated ductwork that passes through an unconditioned or semi-conditioned space in the home.

DEEMED LIFETIME OF EFFICIENT EQUIPMENT

The assumed lifetime of this measure is 20 years.⁴⁷⁹

Note: a mid-life adjustment to account for replacement of HVAC equipment during the measure life should be

⁴⁷⁷Building Performance Institute, Distribution Efficiency Look-up Tables.

<https://www.bpi.org/sites/default/files/Guidance%20on%20Estimating%20Distribution%20Efficiency.pdf>

⁴⁷⁸ Definition matches Regain factor discussed in Home Energy Services Impact Evaluation, prepared for the Massachusetts Residential Retrofit and Low Income Program Area Evaluation, Cadmus Group, Inc., August 2012

⁴⁷⁹ Measure Life Report, Residential and Commercial/Industrial Lighting and HVAC Measures, GDS Associates, June 2007.

applied after 10 years.⁴⁸⁰ See section below for detail.

DEEMED MEASURE COST

The actual duct sealing or insulating measure cost should be used.

LOADSHAPE

Loadshape R08 - Residential Cooling

Loadshape R09 - Residential Electric Space Heat

Loadshape R10 - Residential Electric Heating and Cooling (Shell Measures)

COINCIDENCE FACTOR

The summer peak coincidence factor for cooling is provided in two different ways below. The first is used to estimate peak savings during the utility peak hour and is most indicative of actual peak benefits, and the second represents the *average* savings over the defined summer peak period and is presented so that savings can be bid into PJM’s capacity market.

$$CF_{SSP} = \text{Summer System Peak Coincidence Factor for Central A/C (during utility peak hour)}$$

$$= 68\%^{481}$$

$$CF_{PJM} = \text{PJM Summer Peak Coincidence Factor for Central A/C (average during PJM peak period)}$$

$$= 46.6\%^{482}$$

Algorithm

CALCULATION OF SAVINGS

ELECTRIC ENERGY SAVINGS

For Methodology 1: Modified Blower Door Subtraction, follow steps (a) through (c)

For Methodology 2: Pressurized Duct Test, follow step (c)

- a) Determine Duct Leakage rate before and after performing duct sealing:

$$\text{Duct Leakage (CFM50}_{DL}) = (\text{CFM50}_{\text{Whole House}} - \text{CFM50}_{\text{Envelope Only}}) * \text{SCF}$$

Where:

CFM50_{Whole House} = Standard Blower Door test result finding Cubic Feet per Minute at 50 Pascal pressure differential

CFM50_{Envelope Only} = Blower Door test result finding Cubic Feet per Minute at 50 Pascal pressure differential with all supply and return registers sealed.

SCF = Subtraction Correction Factor to account for underestimation of duct leakage due to connections between the duct system and the home. Determined by measuring pressure in duct system with registers sealed and using look up table provided by Energy Conservatory.

⁴⁸⁰ This is intentionally longer than the assumptions found in the early replacement measures as the application of this measure will occur in a variety of homes that will not be targeted for early replacement HVAC systems.

⁴⁸¹ Based on metering of 24 homes with central AC during PY4 and PY5 in Ameren Illinois service territory.

⁴⁸² Based on analysis of Itron eShape data for Missouri, calibrated to Illinois loads, supplied by Ameren. The average AC load over the PJM peak period (1-5pm, M-F, June through August) is divided by the maximum AC load during the year.

- b) Calculate duct leakage reduction, convert to CFM25_{DL} and factor in Supply and Return Loss Factors
 Duct Leakage Reduction ($\Delta\text{CFM25}_{\text{DL}}$) = (Pre CFM50_{DL} – Post CFM50_{DL}) * 0.64 * (SLF + RLF)

Where:

- 0.64 = Converts CFM50 to CFM25⁴⁸³
 SLF = Supply Loss Factor
 = % leaks sealed located in Supply ducts * 1⁴⁸⁴
 Default = 0.5⁴⁸⁵
 RLF = Return Loss Factor
 = % leaks sealed located in Return ducts * 0.5⁴⁸⁶
 Default = 0.25⁴⁸⁷

- c) Calculate Electric Energy Savings:

- ΔkWh = $\Delta\text{kWh}_{\text{cooling}} + \Delta\text{kWh}_{\text{Fan}}$
 $\Delta\text{kWh}_{\text{cooling}}$ = $((\Delta\text{CFM25}_{\text{DL}} / ((\text{CapacityCool} / 12,000) * 400)) * \text{FLHcool} * \text{CapacityCool} * \text{TRFcool} * \% \text{Cool}) / 1,000 / \eta_{\text{Cool}}$
 $\Delta\text{kWh}_{\text{Fan}}$ = $(\Delta\text{Therms} * F_e * 29.3)$

Where:

- $\Delta\text{CFM25}_{\text{DL}}$ = Duct leakage reduction in CFM25
 = For Methodology 1: Modified Blower Door Subtraction, calculated above
 = For Methodology 2: Pressurized Duct Test, use actual
 CapacityCool = Capacity of Air Cooling system (Btu/hr)
 = Actual
 12,000 = Converts Btu/H capacity to tons
 400 = Converts capacity in tons to CFM (400CFM / ton)⁴⁸⁸
 FLHcool = Full load cooling hours

⁴⁸³ 25 Pascals is the standard assumption for typical pressures experienced in the duct system under normal operating conditions. To convert CFM50 to CFM25 you multiply by 0.64 (inverse of the “Can’t Reach Fifty” factor for CFM25; see Energy Conservatory Blower Door Manual).

⁴⁸⁴ Assumes that for each percent of supply air loss there is one percent annual energy penalty. This assumes supply side leaks are direct losses to the outside and are not recaptured back to the house. This could be adjusted downward to reflect regain of usable energy to the house from duct leaks. For example, during the winter some of the energy lost from supply leaks in a crawlspace will probably be regained back to the house (sometimes 1/2 or more may be regained). More information provided in “Appendix E Estimating HVAC System Loss From Duct Airtightness Measurements” from Energy Conservatory ‘Minneapolis Duct Blaster Operation Manual’.

⁴⁸⁵ Assumes 50% of leaks are in supply ducts.

⁴⁸⁶ Assumes that for each percent of return air loss there is a half percent annual energy penalty. Note that this assumes that return leaks contribute less to energy losses than do supply leaks. This value could be adjusted upward if there was reason to suspect that the return leaks contribute significantly more energy loss than “average” (e.g. pulling return air from a super heated attic), or can be adjusted downward to represent significantly less energy loss (e.g. pulling return air from a moderate temperature crawl space). More information provided in “Appendix E Estimating HVAC System Loss From Duct Airtightness Measurements” from Energy Conservatory ‘Minneapolis Duct Blaster Operation Manual’.

⁴⁸⁷ Assumes 50% of leaks are in return ducts.

⁴⁸⁸ This conversion is an industry rule of thumb; e.g. see ‘Why 400 CFM per ton.pdf’.

= Dependent on location as below:⁴⁸⁹

Climate Zone (City based upon)	FLHcool Single Family	FLHcool Multifamily
1 (Rockford)	547	499
2 (Chicago)	709	629
3 (Springfield)	779	707
4 (Belleville)	1,082	982
5 (Marion)	956	868
Weighted Average ⁴⁹⁰		
ComEd	676	603
Ameren	875	791
Statewide	731	655

Use Multifamily if: Building meets utility’s definition for multifamily and system serves single unit. For residential sized systems serving 2 or more units, assume single family hours. For central systems use Volume 2 Commercial and Industrial Measures.

TRFcool = Thermal Regain Factor for cooling by space type
 = 1.0 for Unconditioned Spaces
 = 0.4 for Semi-Conditioned Spaces⁴⁹¹

%Cool = Percent of homes that have cooling

Central Cooling?	%Cool
Yes	100%
No	0%
Unknown (for use in program evaluation only) ⁴⁹²	66%

1000 = Converts Btu to kBtu

ηCool = Efficiency (SEER2) of Air Conditioning equipment (kBtu/kWh)
 = Actual. If unknown assume the following:⁴⁹³

Age of Equipment	SEER2 Estimate
Before 2006	9.5
After 2006 - 2014	12.4
Central AC After 1/1/2015	12.4
Heat Pump After 1/1/2015	13.3

⁴⁸⁹ Based on Full Load Hours from ENERGY STAR with adjustments made in a Navigant Evaluation, other cities were scaled using those results and CDD. There is a county mapping table in Volume 1, Section 3.7 providing the appropriate city to use for each county of Illinois. During update cycle for version v.12, applied percent change of CDD65, NCEI Annual Normals from 30 yr data set (1981-2010) to more recent 15 yr data (2006-2020) to all FLHcool values.

⁴⁹⁰ Weighting for Ameren is based on electric accounts in each of the cooling zones. Weighting for ComEd and Statewide average is based on number of occupied residential housing units in each zone. ComEd is weighted average of Zones 1-2. Alternative program-weighted assumptions can be used if appropriate.

⁴⁹¹ Thermal regain (i.e. the potential for conditioned air escaping from ducts not being lost to the atmosphere) for residential pipe insulation measures is discussed in Home Energy Services Impact Evaluation, prepared for the Massachusetts Residential Retrofit and Low Income Program Area Evaluation, Cadmus Group, Inc., August 2012.

⁴⁹² Percentage of homes in Illinois that have central cooling from “Table HC7.9 Air Conditioning in Homes in Midwest Region, Divisions, and States, 2009” from Energy Information Administration, 2009 Residential Energy Consumption Survey

⁴⁹³ These default system efficiencies are based on the applicable minimum Federal Standards. In 2006 the Federal Standard for Central AC was adjusted. While one would expect the average system efficiency to be higher than this minimum, the likely degradation of efficiencies over time mean that using the minimum standard is appropriate. Note all ratings have been converted to SEER2 equivalents – since the new rating better reflects the actual efficiency of the units.

Age of Equipment	SEER2 Estimate
Unknown (for use in program evaluation only)	10.0

- Δ Therms = Therm savings as calculated in Fossil Fuel Savings
- F_e = Furnace Fan energy consumption as a percentage of annual fuel consumption
= 3.14%⁴⁹⁴
- 29.3 = kWh per therm

For example, duct sealing in unconditioned space a single family house in Springfield with a 36,000 Btu/H, SEER 11 central air conditioning, an 80% AFUE, 105,000 Btu/H natural gas furnace and the following blower door test results:

Before: $CFM_{50}^{Whole\ House} = 4800\ CFM_{50}$
 $CFM_{50}^{Envelope\ Only} = 4500\ CFM_{50}$
 House to duct pressure of 45 Pascals. = 1.29 SCF (Energy Conservatory look up table)

After: $CFM_{50}^{Whole\ House} = 4600\ CFM_{50}$
 $CFM_{50}^{Envelope\ Only} = 4500\ CFM_{50}$
 House to duct pressure of 43 Pascals = 1.39 SCF (Energy Conservatory look up table)

Duct Leakage:

$CFM_{DL\ before} = (4800 - 4500) * 1.29$
 $= 387\ CFM$

$CFM_{DL\ after} = (4600 - 4500) * 1.39$
 $= 139\ CFM$

Duct Leakage reduction at CFM25:

$\Delta CFM_{25\ DL} = (387 - 139) * 0.64 * (0.5 + 0.25)$
 $= 119\ CFM_{25}$

Energy Savings:

$\Delta kWh_{cooling} = [((119 / ((36,000/12,000) * 400)) * 779 * 36,000 * 1) / 1000 / 11] + (179 * 0.0314 * 29.3)$
 $= 253 + 165$
 $= 418\ kWh$

Heating savings for homes with electric heat:

$$\Delta kWh_{heatingElectric} = ((\Delta CFM_{25\ DL} / ((OutputCapacityHeat / 12,000) * 400)) * FLH_{heat} * OutputCapacityHeat * TRF_{heat} * \%ElectricHeat) / \eta_{Heat} / 3412$$

Where:

- OutputCapacityHeat = Heating output capacity (Btu/hr) of electric heat
=Actual

⁴⁹⁴ F_e is not one of the AHRI certified ratings provided for residential furnaces, but can be reasonably estimated from a calculation based on the certified values for fuel energy (E_f in MMBtu/yr) and E_{ae} (kWh/yr). An average of a 300 record sample (non-random) out of 1495 was 3.14%. This is, appropriately, ~50% greater than the ENERGY STAR version 3 criteria for 2% F_e . See "Programmable Thermostats Furnace Fan Analysis.xlsx" for reference.

FLHheat = Full load heating hours
 = Dependent on location as below:⁴⁹⁵

Climate Zone (City based upon)	FLH_heat
1 (Rockford)	1924
2 (Chicago)	1726
3 (Springfield)	1708
4 (Belleville)	1195
5 (Marion/Murphysboro)	1270
Weighted Average ⁴⁹⁶	
ComEd	1766
Ameren	1547
Statewide	1700

TRFheat = Thermal Regain Factor for heating by space type
 = 0.40 for Semi-Conditioned Spaces
 = 1.0 for Unconditioned Spaces⁴⁹⁷

%ElectricHeat = Percent of homes that have electric space heating
 = 100 % for Electric Resistance or Heat Pump
 = 0 % for Natural Gas
 = If unknown⁴⁹⁸, use the following table:

Utility	Location				
	Single Family	Single Family Low Income	Multi Family	Multi Family Low Income	Unknown
Ameren	18%	26%	38%	39%	29%
ComEd	14%	22%	43%	48%	21%
PGL	1.0%	1.5%	4.0%	2.8%	2.2%
NSG	1.3%	0.8%	32.5%	1.2%	3.3%
Nicor	1.3%	0.8%	32.5%	1.2%	3.3%
All DUs⁴⁹⁹					26%

⁴⁹⁵ Heating EFLH based on ENERGY STAR EFLH for Rockford, Chicago, and Springfield and on NCDC/NOAA HDD for the other two cities. In all cases, the hours were adjusted based on average natural gas heating consumption in IL.

⁴⁹⁶ Weighting for Ameren is based on electric heat accounts in each of the heating zones. Weighting for ComEd and Statewide average is based on number of occupied residential housing units in each zone. ComEd is weighted average of Zones 1-2. Alternative program-weighted assumptions can be used if appropriate.

⁴⁹⁷ Thermal regain (i.e. the potential for conditioned air escaping from ducts not being lost to the atmosphere) for residential pipe insulation measures is discussed in Home Energy Services Impact Evaluation, prepared for the Massachusetts Residential Retrofit and Low Income Program Area Evaluation, Cadmus Group, Inc., August 2012.

⁴⁹⁸ Based on the average % Natural Gas used for space heating in Unknown residential structure types across all utilities covered by the IL program. Residence types include: SF, SF LI, MF & MF LI. Utilities included: Ameren, ComEd, People’s Gas, Northshore Gas & Nicor. Data provided from 2016 Ameren Illinois Demand Side Management (DSM) Market Potential Study by Applied Energy Group, ComEd’s 2019 Baseline Survey on residential space heating share, and PY2022-2023 Implementation Contractors Data for People’s Gas, Northshore Gas & Nicor .

⁴⁹⁹ For the weighted average calculations, please see the Analysis file. PGL, NSG, Nicor & gas customers were assumed to follow the provided split. ComEd total customers, minus overlap with PGL,NSG & Nicor, therefore electric only homes. Ameren is total customers minus Nicor.

Note: If a measure is supported by a gas and electric utility through a joint program, and it is unknown whether the participant has a gas supply, the electric utility values in the table above should be used. If it is known that the participant has a gas supply, the values from the gas utility above should be applied.

η_{Heat} = Efficiency in COP of Heating equipment
 = Actual. If not available use:⁵⁰⁰

System Type	Age of Equipment	HSPF2 Estimate	COP Estimate
Heat Pump (if age unknown, assume 2006-2014)	Before 2006	5.8	1.44
	After 2006 - 2014	6.5	1.62
	2015 on	7.0	1.74
Resistance	N/A	N/A	1.00
Unknown (for use in program evaluation only) ⁵⁰¹	N/A	N/A	1.32

3412 = Converts Btu to kWh

For example, duct sealing in unconditioned space in a 36,000 Btu/H 2.5 COP heat pump heated single family house in Springfield with the blower door results described above:

$$\Delta \text{kWh}_{\text{heating}} = ((119 / ((36,000/12,000) * 400)) * 1,708 * 36,000 * 1 * 1) / 2.5 / 3,412$$

$$= 715 \text{ kWh}$$

Methodology 3: Evaluation of Distribution Efficiency

Determine Distribution Efficiency by evaluating duct system before and after duct sealing or duct insulating using Building Performance Institute “Distribution Efficiency Look-Up Table”.

$$\Delta \text{kWh} = (((DE_{\text{after}} - DE_{\text{before}}) / DE_{\text{after}}) * \text{FLH}_{\text{cool}} * \text{Capacity}_{\text{Cool}} * \text{TRF}_{\text{cool}} * \% \text{Cool}) / 1,000 / \eta_{\text{Cool}}$$

$$+ (\Delta \text{Therms} * F_e * 29.3)$$

Where:

DE_{after} = Distribution Efficiency after duct sealing, see table below⁵⁰²

DE_{before} = Distribution Efficiency before duct sealing, see table below⁵⁰³

Insulation	Sealing	Heating			Cooling		
		Attic	Basement	Vented Crawl	Attic	Basement	Vented Crawl
R-0	Leaky	69%	93%	74%	61%	81%	76%

⁵⁰⁰ These default system efficiencies are based on the applicable minimum Federal Standards. In 2006 the Federal Standard for Heat Pumps was adjusted. While one would expect the average system efficiency to be higher than this minimum, the likely degradation of efficiencies over time means that using the minimum standard is appropriate. Note all ratings have been converted to HSPF2 equivalents – since the new rating better reflects the actual efficiency of the units.

⁵⁰¹ Calculation assumes 35% Heat Pump and 65% Resistance, which is based upon data from Energy Information Administration, 2009 Residential Energy Consumption Survey, see “HC6.9 Space Heating in Midwest Region.xls”, using average for East North Central Region. Average efficiency of heat pump is assumed consistent with the baseline for 2006-2014. Program or evaluation data should be used to improve this assumption if available.

⁵⁰² Building Performance Institute, Distribution Efficiency Look-up Tables, Climate Zones 4-5. <https://www.bpi.org/sites/default/files/Guidance%20on%20Estimating%20Distribution%20Efficiency.pdf>

⁵⁰³ Ibid

Insulation	Sealing	Heating			Cooling		
		Attic	Basement	Vented Crawl	Attic	Basement	Vented Crawl
	Average	73%	94%	78%	64%	87%	83%
	Tight	77%	95%	82%	73%	94%	91%
R-2	Leaky	76%	94%	80%	65%	83%	78%
	Average	82%	96%	85%	74%	88%	85%
	Tight	87%	97%	90%	84%	95%	93%
R-4	Leaky	79%	95%	82%	67%	83%	79%
	Average	84%	96%	87%	77%	89%	86%
	Tight	90%	98%	92%	87%	95%	94%
R-8	Leaky	80%	95%	84%	69%	83%	79%
	Average	86%	97%	89%	79%	89%	87%
	Tight	92%	98%	94%	90%	95%	94%

FLHcool = Full load cooling hours
 = Dependent on location as below:⁵⁰⁴

Climate Zone (City based upon)	FLHcool Single Family	FLHcool Multifamily
1 (Rockford)	547	499
2 (Chicago)	709	629
3 (Springfield)	779	707
4 (Belleville)	1,082	982
5 (Marion)	956	868
Weighted Average ⁵⁰⁵		
ComEd	676	603
Ameren	875	791
Statewide	731	655

Use Multifamily if: Building meets utility’s definition for multifamily and system serves single unit. For residential sized systems serving 2 or more units, assume single family hours. For central systems use Volume 2 Commercial and Industrial Measures.

CapacityCool = Capacity of Air Cooling system (Btu/hr)
 = Actual

TRFcool = Thermal Regain Factor for cooling by space type
 = 1.0 for Unconditioned Spaces
 = 0.4 for Semi-Conditioned Spaces⁵⁰⁶

%Cool = Percent of homes that have cooling

⁵⁰⁴ Based on Full Load Hours from ENERGY STAR with adjustments made in a Navigant Evaluation, other cities were scaled using those results and CDD. There is a county mapping table in Volume 1, Section 3.7 providing the appropriate city to use for each county of Illinois. During update cycle for version v.12, applied percent change of CDD65, NCEI Annual Normals from 30 yr data set (1981-2010) to more recent 15 yr data (2006-2020) to all FLHcool values.

⁵⁰⁵ Weighting for Ameren is based on electric accounts in each of the cooling zones. Weighting for ComEd and Statewide average is based on number of occupied residential housing units in each zone. ComEd is weighted average of Zones 1-2. Alternative program-weighted assumptions can be used if appropriate.

⁵⁰⁶ Thermal regain for residential pipe insulation measures is discussed in Home Energy Services Impact Evaluation, prepared for the Massachusetts Residential Retrofit and Low Income Program Area Evaluation, Cadmus Group, Inc., August 2012.

Central Cooling?	%Cool
Yes	100%
No	0%
Unknown (for use in program evaluation only) ⁵⁰⁷	66%

1000 = Converts Btu to kBtu
 η_{Cool} = Efficiency (SEER2) of Air Conditioning equipment (kBtu/kWh)
 = Actual. If unknown assume:⁵⁰⁸

Age of Equipment	SEER2 Estimate
Before 2006	9.5
After 2006 – 2014	12.4
Central AC After 1/1/2015	12.4
Heat Pump After 1/1/2015	13.3
Unknown (for use in program evaluation only)	10.0

For example, duct sealing in unconditioned space in a single family house in Springfield, with 36,000 Btu/H SEER 11 central air conditioning, an 80% AFUE, 105,000 Btu/H natural gas furnace and the following duct evaluation results:

$$\begin{aligned}
 DE_{before} &= 0.85 \\
 DE_{after} &= 0.92 \\
 \text{Energy Savings:} \\
 \Delta kWh_{cooling} &= (((0.92 - 0.85)/0.92) * 779 * 36,000 * 1 * 1) / 1000 / 11 + (179 * 0.0314 * 29.3) \\
 &= 194 + 165 \\
 &= 359 \text{ kWh}
 \end{aligned}$$

Heating savings for homes with electric heat:

$$\Delta kWh_{heatingElectric} = ((DE_{after} - DE_{before}) / DE_{after}) * FLH_{heat} * OutputCapacity_{heat} * TRF_{heat} * \%Electric_{heat} / \eta_{heat} / 3412$$

Where:

OutputCapacity_{heat} = Heating output capacity (Btu/hr) of the electric heat
 = Actual
 FLH_{heat} = Full load heating hours
 = Dependent on location as below:⁵⁰⁹

⁵⁰⁷ Percentage of homes in Illinois that have central cooling from “Table HC7.9 Air Conditioning in Homes in Midwest Region, Divisions, and States, 2009” from Energy Information Administration, 2009 Residential Energy Consumption Survey

⁵⁰⁸ These default system efficiencies are based on the applicable minimum Federal Standards. In 2006 the Federal Standard for Central AC was adjusted. While one would expect the average system efficiency to be higher than this minimum, the likely degradation of efficiencies over time means that using the minimum standard is appropriate. Note all ratings have been converted to SEER2 equivalents – since the new rating better reflects the actual efficiency of the units.

⁵⁰⁹ Heating EFLH based on ENERGY Star EFLH for Rockford, Chicago, and Springfield and on NCDC/NOAA HDD for the other two cities. In all cases, the hours were adjusted based on average natural gas heating consumption in IL.

Climate Zone (City based upon)	FLH_heat
1 (Rockford)	1924
2 (Chicago)	1726
3 (Springfield)	1708
4 (Belleville)	1195
5 (Marion)	1270
Weighted Average ⁵¹⁰	1766
ComEd	1547
Ameren	1700
Statewide	

TRFheat = Thermal Regain Factor for heating by space type
 = 0.40 for Semi-Conditioned Spaces
 = 1.0 for Unconditioned Spaces⁵¹¹

%ElectricHeat = Percent of homes that have electric space heating
 = 100 % for Electric Resistance or Heat Pump
 = 0 % for Natural Gas
 = If unknown⁵¹², use the following table:

Utility	Location				
	Single Family	Single Family Low Income	Multi Family	Multi Family Low Income	Unknown
Ameren	18%	26%	38%	39%	29%
ComEd	14%	22%	43%	48%	21%
PGL	1.0%	1.5%	4.0%	2.8%	2.2%
NSG	1.3%	0.8%	32.5%	1.2%	3.3%
Nicor	1.3%	0.8%	32.5%	1.2%	3.3%
All DUs⁵¹³					26%

Note: If a measure is supported by a gas and electric utility through a joint program, and it is unknown whether the participant has a gas supply, the electric utility values in the table above should be used. If it is known that the participant has a gas supply, the values from the gas utility above should be applied.

⁵¹⁰ Weighting for Ameren is based on electric heat accounts in each of the heating zones. Weighting for ComEd and Statewide average is based on number of occupied residential housing units in each zone. ComEd is weighted average of Zones 1-2. Alternative program-weighted assumptions can be used if appropriate.

⁵¹¹ Thermal regain for residential pipe insulation measures is discussed in Home Energy Services Impact Evaluation, prepared for the Massachusetts Residential Retrofit and Low Income Program Area Evaluation, Cadmus Group, Inc., August 2012.

⁵¹² Based on the average % Natural Gas used for space heating in Unknown residential structure types across all utilities covered by the IL program. Residence types include: SF, SF LI, MF & MF LI. Utilities included: Ameren, ComEd, People’s Gas, Northshore Gas & Nicor. Data provided from 2016 Ameren Illinois Demand Side Management (DSM) Market Potential Study by Applied Energy Group, ComEd’s 2019 Baseline Survey on residential space heating share, and PY2022-2023 Implementation Contractors Data for People’s Gas, Northshore Gas & Nicor .

⁵¹³ For the weighted average calculations, please see the Analysis file. PGL, NSG, Nicor & gas customers were assumed to follow the provided split. ComEd total customers, minus overlap with PGL,NSG & Nicor, therefore electric only homes. Ameren is total customers minus Nicor.

COP = Coefficient of Performance of electric heating system⁵¹⁴
 = Actual. If not available use:⁵¹⁵

System Type	Age of Equipment	HSPF2 Estimate	COP Estimate
Heat Pump (if age unknown, assume 2006-2014)	Before 2006	5.8	1.44
	After 2006 – 2014	6.5	1.62
	2015 on	7.0	1.74
Resistance	N/A	N/A	1.00
Unknown (for use in program evaluation only) ⁵¹⁶	N/A	N/A	1.32

For example, duct sealing in unconditioned space in a 36,000 Btu/H, 2.5 COP heat pump heated single family house in Springfield with the following duct evaluation results:

$$DE_{\text{after}} = 0.92$$

$$DE_{\text{before}} = 0.85$$

Energy Savings:

$$\Delta kWh_{\text{heating}} = ((0.92 - 0.85)/0.92) * 1,708 * 36,000 * 1 * 1) / 2.5) / 3,412$$

$$= 549 \text{ kWh}$$

SUMMER COINCIDENT PEAK DEMAND SAVINGS

$$\Delta kW = \Delta kWh_{\text{cooling}} / FLH_{\text{cool}} * CF$$

Where:

FLH_{cool} = Full load cooling hours:
 = Dependent on location as below:⁵¹⁷

Climate Zone (City based upon)	FLH _{cool} Single Family	FLH _{cool} Multifamily
1 (Rockford)	547	499
2 (Chicago)	709	629
3 (Springfield)	779	707
4 (Belleville)	1,082	982

⁵¹⁴ Note that the HSPF2 of a heat pump is equal to the COP * 3.413.

⁵¹⁵ These default system efficiencies are based on the applicable minimum Federal Standards. In 2006 the Federal Standard for Heat Pumps was adjusted. While one would expect the average system efficiency to be higher than this minimum, the likely degradation of efficiencies over time means that using the minimum standard is appropriate. Note all ratings have been converted to HSPF2 equivalents – since the new rating better reflects the actual efficiency of the units.

⁵¹⁶ Calculation assumes 35% Heat Pump and 65% Resistance, which is based upon data from Energy Information Administration, 2009 Residential Energy Consumption Survey, see “HC6.9 Space Heating in Midwest Region.xls”, using average for East North Central Region. Average efficiency of heat pump is assumed consistent with the baseline for 2006-2014. Program or evaluation data should be used to improve this assumption if available.

⁵¹⁷ Based on Full Load Hours from ENERGY Star with adjustments made in a Navigant Evaluation, other cities were scaled using those results and CDD. There is a county mapping table in Volume 1, Section 3.7 providing the appropriate city to use for each county of Illinois. During update cycle for version v.12, applied percent change of CDD65, NCEI Annual Normals from 30 yr data set (1981-2010) to more recent 15 yr data (2006-2020) to all FLH_{cool} values.

5 (Marion)	956	868
Weighted Average ⁵¹⁸		
ComEd	676	603
Ameren	875	791
Statewide	731	655

Use Multifamily if: Building meets utility’s definition for multifamily and system serves single unit. For residential sized systems serving 2 or more units, assume single family hours. For central systems use Volume 2 Commercial and Industrial Measures.

CF_{SSP} = Summer System Peak Coincidence Factor for Central A/C (during system peak hour)
 = 68%⁵¹⁹

CF_{PJM} = PJM Summer Peak Coincidence Factor for Central A/C (average during peak period)
 = 46.6%⁵²⁰

FOSSIL FUEL SAVINGS

For homes with Fossil Fuel Heating:

Methodology 1: Modified Blower Door Subtraction

Methodology 2: Pressurized Duct Test

$$\Delta_{Therm} = (((\Delta CFM_{25_{DL}} / (\text{InputCapacityHeat} * 0.0123)) * FLH_{heat} * \text{InputCapacityHeat} * TRF_{heat} * \%FossilHeat * (\eta_{Equipment} / \eta_{System})) / 100,000$$

Where:

$\Delta CFM_{25_{DL}}$ = Duct leakage reduction in CFM25

InputCapacityHeat = Heating input capacity (Btu/hr)
 =Actual

0.0123 = Conversion of Capacity to CFM (0.0123CFM / Btu/hr)⁵²¹

FLH_{heat} = Full load heating hours
 =Dependent on location as below:⁵²²

Climate Zone (City based upon)	FLH _{heat}
1 (Rockford)	1924
2 (Chicago)	1726

⁵¹⁸ Weighting for Ameren is based on electric accounts in each of the cooling zones. Weighting for ComEd and Statewide average is based on number of occupied residential housing units in each zone. ComEd is weighted average of Zones 1-2. Alternative program-weighted assumptions can be used if appropriate.

⁵¹⁹ Based on metering of 24 homes with central AC during PY4 and PY5 in Ameren Illinois service territory.

⁵²⁰ Based on analysis of Itron eShape data for Missouri, calibrated to Illinois loads, supplied by Ameren. The average AC load over the PJM peak period (1-5pm, M-F, June through August) is divided by the maximum AC load during the year.

⁵²¹ Based on Natural Draft Furnaces requiring 100 CFM per 10,000 Btu, Induced Draft Furnaces requiring 130CFM per 10,000Btu and Condensing Furnaces requiring 150 CFM per 10,000 Btu (rule of thumb from [‘Practical Standards to Measure HVAC System Performance’](#)). Data provided by GAMA during the federal rule-making process for furnace efficiency standards, suggested that in 2000, 24% of furnaces purchased in Illinois were condensing units. Therefore, a weighted average required airflow rate is calculated assuming a 50:50 split of natural v induced draft non-condensing furnaces, as 123 per 10,000Btu or 0.0123/Btu.

⁵²² Heating EFLH based on ENERGY Star EFLH for Rockford, Chicago, and Springfield and on NCDC/NOAA HDD for the other two cities. In all cases, the hours were adjusted based on average natural gas heating consumption in IL. During update cycle for version v.12, applied percent change of HDD60, NCEI Annual Normals from 30 yr data set (1981-2010) to more recent 15 yr data (2006-2020) to all FLH_{heat} values.

Climate Zone (City based upon)	FLH_heat
3 (Springfield)	1708
4 (Belleville)	1195
5 (Marion)	1270
Weighted Average ⁵²³	
ComEd	1766
Ameren	1543
Statewide	1700

- TRFheat = Thermal Regain Factor for heating by space type
 = 0.40 for Semi-Conditioned Spaces
 = 1.0 for Unconditioned Spaces⁵²⁴
- %FossilHeat = Percent of homes that have gas space heating
 = 100 % for Natural Gas
 = 0 % for Electric Resistance or Heat Pump
 = If unknown⁵²⁵, use the following table:

Utility	Location				
	Single Family	Single Family Low Income	Multi Family	Multi Family Low Income	Unknown
Ameren	82%	74%	62%	61%	71%
ComEd	86%	78%	57%	52%	79%
PGL	98.9%	98.5%	96.0%	96.9%	97.7%
NSG	98.3%	99.2%	67.5%	98.8%	96.6%
Nicor	98.3%	99.2%	67.5%	98.8%	96.6%
All DUs⁵²⁶					74%

Note: If a measure is supported by a gas and electric utility, utilize the assumptions above for the gas utility

- 100,000 = Converts Btu to therms
 η Equipment = Heating Equipment Efficiency

⁵²³ Weighting for Ameren is based on electric heat accounts in each of the heating zones. Weighting for ComEd and Statewide average is based on number of occupied residential housing units in each zone. ComEd is weighted average of Zones 1-2. Alternative program-weighted assumptions can be used if appropriate.

⁵²⁴ Thermal regain for residential pipe insulation measures is discussed in Home Energy Services Impact Evaluation, prepared for the Massachusetts Residential Retrofit and Low Income Program Area Evaluation, Cadmus Group, Inc., August 2012.

⁵²⁵ Based on the average % Natural Gas used for space heating in Unknown residential structure types across all utilities covered by the IL program. Residence types include: SF, SF LI, MF & MF LI. Utilities included: Ameren, ComEd, People’s Gas, Northshore Gas & Nicor. Data provided from 2016 Ameren Illinois Demand Side Management (DSM) Market Potential Study by Applied Energy Group, ComEd’s 2019 Baseline Survey on residential space heating share, and PY2022-2023 Implementation Contractors Data for People’s Gas, Northshore Gas & Nicor .

⁵²⁶ For the weighted average calculations, please see the Analysis file. PGL, NSG, Nicor & gas customers were assumed to follow the provided split. ComEd total customers, minus overlap with PGL,NSG & Nicor, therefore gas only homes. Ameren is total customers minus Nicor.

= Actual.⁵²⁷ If not available, use 83%.⁵²⁸

η_{System} = Pre duct sealing Heating System Efficiency (Equipment Efficiency * Pre Distribution Efficiency)⁵²⁹

= Actual. If not available, use 70%.⁵³⁰

For example, duct sealing in unconditioned space in a house in Springfield with an 80% AFUE, 105,000 Btu/H (input capacity) natural gas furnace and the following blower door test results:

Before: CFM50_{Whole House} = 4800 CFM50
 CFM50_{Envelope Only} = 4500 CFM50
 House to duct pressure of 45 Pascals = 1.29 SCF (Energy Conservatory look up table)

After: CFM50_{Whole House} = 4600 CFM50
 CFM50_{Envelope Only} = 4500 CFM50
 House to duct pressure of 43 Pascals = 1.39 SCF (Energy Conservatory look up table)

Duct Leakage:

CFM50_{DL before} = (4800 – 4500) * 1.29
 = 387 CFM

CFM50_{DL after} = (4600 – 4500) * 1.39
 = 119 CFM

Duct Leakage reduction at CFM25:

$\Delta CFM25_{DL}$ = (387 – 119) * 0.64 * (0.5 + 0.25)
 = 119 CFM25

Energy Savings:

Pre Distribution Efficiency = 1 – (387/4800) = 92%

η_{System} = 80% * 92% = 74%

$\Delta Therm$ = ((119 / (105,000 * 0.0123)) * 1,708 * 105,000 * 1 * (0.8/0.74)) / 100,000
 = 179 therms

Methodology 3: Evaluation of Distribution Efficiency

$$\Delta Therm = ((DE_{after} - DE_{before}) / DE_{after}) * FLHeat * InputCapacityHeat * TRFheat * \%FossilHeat *$$

⁵²⁷ The Equipment Efficiency can be obtained either by recording the AFUE of the unit, or performing a steady state efficiency test.

If there are more than one heating systems, the weighted (by consumption) average efficiency should be used.

If the heating system or distribution is being upgraded within a package of measures together with the insulation upgrade, the new average heating system efficiency should be used.

⁵²⁸ This has been estimated assuming that natural gas central furnace heating is typical for Illinois residences (66% of Illinois homes have a Natural Gas Furnace (based on Energy Information Administration, 2009 Residential Energy Consumption Survey). In 2000, 24% of furnaces purchased in Illinois were condensing (based on data from GAMA, provided to Department of Energy during the federal standard setting process for residential heating equipment - see Furnace Penetration.xls). Furnaces tend to last up to 20 years and so units purchased 10 years ago provide a reasonable proxy for the current mix of furnaces in the State. Assuming typical efficiencies for condensing and non-condensing furnaces and duct losses, the average heating system efficiency is estimated as follows:
 (0.24*0.92) + (0.76*0.8) = 0.829

⁵²⁹ The Distribution Efficiency can be estimated via a visual inspection and by referring to a look up table such as that provided by the Building Performance Institute: (see 'DistributionEfficiencyTable-Blue Sheet') or by performing duct blaster testing.

⁵³⁰ Estimated as follows: 0.829 * (1-0.15) = 0.70

$$(\eta_{\text{Equipment}} / \eta_{\text{System}}) / 100,000$$

Where:

DE_{after} = Distribution Efficiency after duct sealing, refer to table in electric savings section

DE_{before} = Distribution Efficiency before duct sealing, refer to table in electric savings section

Other factors as defined above.

For example, duct sealing in unconditioned space in a house in Springfield an 80% AFUE, 105,000 Btu/H (input capacity) natural gas furnace and the following duct evaluation results:

$$DE_{\text{after}} = 0.92$$

$$DE_{\text{before}} = 0.85$$

Energy Savings:

$$\eta_{\text{System}} = 80\% * 85\% = 68\%$$

$$\Delta_{\text{Therm}} = (((0.92 - 0.85) / 0.92) * 1,708 * 105,000 * 1 * 1 * (0.8 / 0.68)) / 100,067$$

$$= 160 \text{ therm}$$

Mid-Life Adjustment

In order to account for the likely replacement of existing heating and cooling equipment during the lifetime of this measure, a mid-life adjustment should be applied.

For electric HVAC, to calculate the adjustment, re-calculate the savings using the algorithms in the ‘Electric Energy Savings’ section using the following new baseline system efficiency assumptions:

Efficiency Assumption	System Type	New Baseline Efficiency
ηCool	Central AC	13.4 SEER2
	Heat Pump	14.3 SEER2
ηHeat	Heat Pump (7.5/3.413)	2.20 COP

For gas fueled systems, because the algorithm uses input capacity (which already accounts for the equipment efficiency), the *change* in equipment efficiency needs to be accounted for. Therefore, re-calculate the savings using the following algorithm:

Methodology 1: Modified Blower Door Subtraction

Methodology 2: Pressurized Duct Test

$$\Delta_{\text{Therms}} = ((\Delta_{\text{CFM}25_{\text{DL}}} / (\text{InputCapacityHeat} * 0.0123)) * \text{FLHheat} * \text{InputCapacityHeat} * \text{TRFheat} * \%_{\text{FossilHeat}} * (\eta_{\text{Equipment}} / (\eta_{\text{Equipment}_{\text{New}}} * DE_{\text{after}}))) / 100,000$$

Where:

$$\eta_{\text{Equipment}_{\text{New}}} = 80\% \text{ AFUE}$$

$$DE_{\text{after}} = \text{Distribution efficiency after duct sealing}$$

$$= 1 - (\text{CFM}50_{\text{DL After}} / \text{CFM}50_{\text{Whole House After}})$$

Methodology 3: Evaluation of Distribution Efficiency

$$\Delta\text{Therms} = ((\text{DE}_{\text{after}} - \text{DE}_{\text{before}}) / \text{DE}_{\text{after}}) * \text{FLHheat} * \text{InputCapacityHeat} * \text{TRFheat} * \% \text{FossilHeat} * (\eta_{\text{Equipment}} / (\eta_{\text{EquipmentNew}} * \text{DE}_{\text{after}})) / 100,000$$

Where:

$\eta_{\text{EquipmentNew}}$ = 80% AFUE

DE_{after} = Distribution efficiency after duct sealing

= As evaluated using the Building Performance Institutes 'Distribution Efficiency Look-Up Table'

The re-calculated reduced annual savings should be applied following the assumed remaining useful life of the existing equipment, estimated to be 10 years.⁵³¹ Note: if the existing equipment efficiency is greater than the new baseline efficiency listed above, do not apply a mid-life adjustment.

WATER IMPACT DESCRIPTIONS AND CALCULATION

N/A

DEEMED O&M COST ADJUSTMENT CALCULATION

N/A

MEASURE CODE: RS-HVC-DINS-V13-250101

REVIEW DEADLINE: 1/1/2028

⁵³¹ This is intentionally longer than the assumption found in the early replacement measures as the application of this measure will occur in a variety of homes and will not be targeting those homes appropriate for early replacement HVAC systems.

5.3.5 Furnace Blower Motor

DESCRIPTION

This measure describes savings from a brushless permanent magnet (BPM) motor (known and referred in this measure as an electronically commutated motor (ECM)) compared to a lower efficiency motor. Time of Sale and New Construction replacement scenarios no longer apply to this measure, as federal standards make ECM blower fan motors a requirement for residential furnaces.⁵³² Savings however are available from retrofitting an ECM motor into an existing furnace, or replacing an operational inefficient furnace with a new furnace with an ECM prior to the end of its life.

This measure characterizes the electric savings associated with the fan and the interactive negative therm savings due to a reduction in waste heat of the fan when operating in heating mode.

Savings decrease sharply with static pressure so duct improvements, and clean, low pressure drop filters can maximize savings. Savings occur when the blower is used for heating, cooling as well as when it is used for continuous ventilation, but only if the non-ECM motor would have been used for continuous ventilation too. If the resident runs the ECM blower continuously because it is a more efficient motor and would not run a non-ECM motor that way, savings are near zero and possibly negative. This characterization uses a 2016 Ameren Illinois study of ECM blower motors in Illinois, which accounted for the effects of this behavioral impact through surveyed results of impacted homeowners.

Retrofitting an existing blower motor with a new ECM reduces the potential impact of the high efficiency motor over a new system designed for an ECM blower motor because existing systems were not designed to capitalize and take advantage of the ECM's multi-staging features. Energy and demand savings are limited to the efficiency gains from the motor itself.

Note: as part of a Time of Sale measure, it is not appropriate to claim additional ECM fan savings due to installing a new furnace or CAC unit as ECM motors are now baseline for new furnaces and the SEER2/EER2 ratings of a CAC unit already account for this electrical load.

In an early replacement furnace situation, ECM fan heating savings can be claimed for the RUL of the existing furnace, and cooling savings can be claimed for the RUL of the CAC if an existing cooling unit is not replaced.

If a new CAC unit is installed in a home where the existing furnace is not replaced, heating ECM savings should only be claimed if it can be demonstrated that the new CAC motor will be used for the heating load.

This measure was developed to be applicable to the following program types: RF, EREP

If applied to other program types, the measure savings should be verified.

DEFINITION OF EFFICIENT EQUIPMENT

A brushless permanent magnet (ECM) blower motor, also known by the trademark ECM, BLDC, and other names.

DEFINITION OF BASELINE EQUIPMENT

A non-ECM blower motor.

DEEMED LIFETIME OF EFFICIENT EQUIPMENT

The expected measure life is assumed to be 6 years, which is the remaining life of existing furnaces.⁵³³

⁵³² As part of the code of federal regulations, energy conservation standards for covered residential furnace fans become effective on July 3, 2019 (10 CFR 430.32(y)). The expectation is the baseline will essentially become an ECM motor.

⁵³³ While ECM blower motors have an effective useful life of 15 year (consistent with assumed life of a BPM/ECM motor, Appendix 8-E of the DOE Technical support documents for federal residential appliance standards) as this is a retrofit measure

DEEMED MEASURE COST

The capital cost for this measure as a retrofit should be actual if known; if unknown, assume \$350.⁵³⁴ In cases of furnace early replacements, it is assumed the incremental cost of the ECM is \$0.

LOADSHAPE

- Loadshape R08 - Residential Cooling
- Loadshape R09 - Residential Electric Space Heat
- Loadshape R10 - Residential Electric Heating and Cooling

COINCIDENCE FACTOR

ECMs installed in high efficiency CACs and ASHPs do not generate peak demand cooling savings if demand savings are claimed for these systems. However, some savings are realized for fans operating in circulation mode, even during peak demand cooling periods. Circulation mode operation during peak cooling periods would only occur when a system is not operating in cooling mode, with the percent time in circulation mode calculated using the summer system peak and PJM peak coincidence factors. A metering study found 23% of fans operated continuously during the summer peak periods;⁵³⁵ therefore, ECMs do generate some demand savings during peak periods (when the system is not cooling). ECMs installed with CACs or ASHPs not receiving a rebate improve the cooling efficiency and therefore generate additional peak demand savings (when the system is cooling). Demand savings vary with system size and can be calculated using factors listed in the demand savings calculation table in the next section which incorporate coincidence with peak in their calculation.

Algorithm

CALCULATION OF SAVINGS

ELECTRIC ENERGY SAVINGS

$$\Delta kWh = Capacity_cooling * kWhSavingsPerTon$$

Where:

Capacity_cooling = Capacity of cooling system in tons
 = Actual (1 ton = 12,000Btu/hr)

kWhSavingsPerTon = Blower fan kWh savings per ton of cooling⁵³⁶

The per-ton energy savings values vary by system installation scenario and location as provided below. Assumptions are also provided for installation with no or unknown cooling system.

on an existing furnace blower motor, the remaining useful life of that equipment is used. For more detail, please see 5.3.7 Gas High Efficiency Furnace

⁵³⁴ The cost of a typical replacement motor is estimated at \$180 based on quotes from online suppliers, plus \$17 for the bracket. Typical labor costs are estimated at between \$140 and \$190 based on program experience provided by Staples in April 2022. A total retrofit measure cost is therefore estimated at \$350.

⁵³⁵ See Opinion Dynamics and Cadmus metering study of Ameren HVAC program participants; See 'AIC HVAC Metering Study Memo FINAL 2_28_2018'.

⁵³⁶ Tons of cooling was determined to be the most straightforward multiplier to apply to systems in which the BPM is installed. The basis of the values and for more information see Opinion Dynamics and Cadmus metering study of Ameren HVAC program participants; See 'AIC HVAC Metering Study Memo FINAL 2_28_2018'.

Region	Existing ASHP	Existing CAC	Furnace, No Cooling System*	Furnace, Cooling System unknown* ⁵³⁷
Rockford	247	229	210	223
Chicago	245	230	208	222
Springfield	249	231	203	221
Belleville	247	235	196	222
Marion	242	231	196	219
Average	247	230	206	222

*Multiply kWh saved value by 2 tons for furnaces <70 kBTU, by 3 tons for furnaces 70 kBTU – 90 kBTU and by 4 tons for furnaces 90+ kBTU.

For example, an BPM installed in an existing 3-ton, 16 SEER CAC in a home in Marion:

$$\Delta \text{kWh} = 3 * 231$$

$$= 693 \text{ kWh}$$

SUMMER COINCIDENT PEAK DEMAND SAVINGS

$$\Delta \text{kW} = \text{Capacity_cooling} * \text{kWSavingsPerTon}$$

Where:

$$\text{kWSavingsPerTon} = \text{Blower fan kW savings per ton of cooling}^{538}$$

The per-ton energy savings values vary by system installation scenario and location as provided below. Assumptions are also provided for installation with no or unknown cooling system.

Demand Savings Type	Existing ASHP	Existing CAC	Furnace, No Cooling System*	Furnace, Cooling System unknown* ⁵³⁹
SSP	0.085	0.085	0.013	0.065
PJM	0.064	0.064	0.009	0.048

*Multiply kWh saved value by 2 tons for furnaces <70 kBTU, by 3 tons for furnaces 70 kBTU – 90 kBTU and by 4 tons for furnaces 90+ kBTU.

⁵³⁷ Unknown cooling system values are based on a weight of 66% existing CAC and 34% no cooling factors. Based on 66% of homes in Illinois having central cooling ("Table HC7.9 Air Conditioning in Homes in Midwest Region, Divisions, and States, 2009 from Energy Information Administration", 2009 Residential Energy Consumption Survey)

⁵³⁸ Tons of cooling was determined to be the most straightforward multiplier to apply to systems in which the BPM is installed. The basis of the values and for more information see Opinion Dynamics and Cadmus metering study of Ameren HVAC program participants; See 'AIC HVAC Metering Study Memo FINAL 2_28_2018'.

⁵³⁹ Unknown cooling system values are based on a weight of 66% existing CAC and 34% no cooling factors. Based on 66% of homes in Illinois having central cooling ("Table HC7.9 Air Conditioning in Homes in Midwest Region, Divisions, and States, 2009 from Energy Information Administration", 2009 Residential Energy Consumption Survey)

For example, a BPM installed in an existing 3-ton, 16 SEER CAC receiving a rebate in a home in Marion:

$$\begin{aligned} \Delta kW_{ssp} &= 3 * 0.0085 \\ &= 0.0255 \text{ kW} \\ \Delta kW_{pjm} &= 3 * 0.064 \\ &= 0.192 \text{ kW} \end{aligned}$$

FOSSIL FUEL SAVINGS

$$\Delta \text{therms}^{540} = - \text{HeatingkWhSavings} * 0.03412 / \text{AFUE}$$

Where:

$$\text{HeatingkWhSavings} = \text{Heating kWh savings per ton of cooling}^{541}$$

Use the location-specific values in the following table to determine heating savings based on the size of the cooling system. If cooling size is unknown, assume 2 tons for furnaces <70 kBTU, 3 tons for furnaces 70 kBTU – 90 kBTU, and 4 tons for furnaces 90+ kBTU. If heating size is unknown or if the system does not include cooling, assume a 3-ton system.

Region	Heating Savings (kWh per ton of cooling)
Rockford	61
Chicago	59
Springfield	50
Belleville	39
Marion	39
Average	56

0.03412 = Converts kWh to therms

AFUE = Efficiency of the Furnace

= Actual. If unknown, assume 64.4 AFUE% for the existing furnace.⁵⁴²

For example, an ECM installed in an existing 3-ton CAC and 95% AFUE furnace in a home in Marion:

$$\begin{aligned} \Delta \text{therms} &= (-39 \text{ kWh} * 3 \text{ tons} * 0.03412) / 0.95 \\ \Delta \text{therms} &= - 4.2 \text{ therms} \end{aligned}$$

WATER IMPACT DESCRIPTIONS AND CALCULATION

N/A

DEEMED O&M COST ADJUSTMENT CALCULATION

N/A

⁵⁴⁰ The blower fan is in the heating duct so all, or very nearly all, of its waste heat is delivered to the conditioned space. Negative value since this measure will increase the heating load due to reduced waste heat.

⁵⁴¹ Tons of cooling was determined to be the most straightforward multiplier to apply to systems in which the BPM is installed. The basis of the values and for more information see Opinion Dynamics and Cadmus metering study of Ameren HVAC program participants; See ‘AIC HVAC Metering Study Memo FINAL 2_28_2018’.

⁵⁴² Average nameplate efficiencies of all Early Replacement qualifying equipment in Ameren PY3-PY4.

MEASURE CODE: RS-HVC-FBMT-V09-240101

REVIEW DEADLINE: 1/1/2028

5.3.6 Gas High Efficiency Boiler

DESCRIPTION

High efficiency boilers achieve most gas savings through the utilization of a sealed combustion chamber and multiple heat exchangers that remove a significant portion of the waste heat from flue gasses. Because multiple heat exchangers are used to remove waste heat from the escaping flue gasses, some of the flue gasses condense and must be drained.

This measure characterizes:

- a) Time of Sale:
 - a. The installation of a new high efficiency, gas-fired hot water boiler in a residential location meeting efficiency specifications determined by the program. This could relate to the replacement of an existing unit at the end of its useful life, or the installation of a new system in a new home.

- b) Early Replacement:

Early Replacement determination will be based on meeting the following conditions:

- The existing unit is operational when replaced, or
- The existing unit requires minor repairs (<\$709).⁵⁴³
- All other conditions will be considered Time of Sale.

The Baseline AFUE of the existing unit replaced:

- If the AFUE of the existing unit is known the Baseline AFUE is the actual AFUE value of the unit replaced.
- If the AFUE of the existing unit is unknown, use assumptions in variable list below (AFUE_{Exist}).
- If the operational status or repair cost of the existing unit is unknown, use time of sale assumptions.

A weighted average early replacement rate is provided for use in programs when the actual baseline early replacement rates are unknown.⁵⁴⁴

Deemed Early Replacement Rates for Boilers

	Deemed Early Replacement Rate
Early Replacement Rate for Boiler participants	7%

This measure was developed to be applicable to the following program types: TOS, NC, EREP. If applied to other program types, the measure savings should be verified.

DEFINITION OF EFFICIENT EQUIPMENT

To qualify for this measure the installed Boiler must meet the requirements determined by the program. For reference the ENERGY STAR specification is an AFUE rated at or greater than 90% and input capacity less than

⁵⁴³ The Technical Advisory Committee agreed that if the cost of repair is less than 20% of the new baseline replacement cost it can be considered early replacement. Note the non-inflated cost is used as this would be a cost consideration in the program year.

⁵⁴⁴ Based upon research from “Home Energy Efficiency Rebate Program GPY2 Evaluation Report” which outlines early replacement rates for both primary and secondary central air cooling (CAC) and residential furnaces. This is used as a reasonable proxy for boiler installations since boiler specific data is not available. Report presented to Nicor Gas Company February 27, 2014.

300,000 Btu/hr.⁵⁴⁵

DEFINITION OF BASELINE EQUIPMENT

Time of sale: The baseline equipment for this measure is a new, gas-fired, standard-efficiency water boiler. The baseline AFUE is assumed to be 84% and is based on minimum federal appliance standards for boilers manufactured on or after January 15, 2021.⁵⁴⁶

Early replacement: The baseline for this measure is the efficiency of the existing equipment for the assumed remaining useful life of the unit and the new baseline as defined above for the remainder of the measure life. Consistent with TRM Volume 1 Section 2.3.1 for midstream programs or other cases where the existing condition is unknown, it may be appropriate to apply a deemed percent split of Time of Sale and Early Replacement assumptions based on evaluation results

DEEMED LIFETIME OF EFFICIENT EQUIPMENT

The expected measure life is assumed to be 25 years.⁵⁴⁷

Early replacement: Remaining life of existing equipment is assumed to be 8 years.⁵⁴⁸

DEEMED MEASURE COST

Time of sale: The incremental install cost for this measure is dependent on tier:⁵⁴⁹

	Installation Cost	Incremental Install Cost
Baseline	\$5,001	n/a
AFUE 90% (ENERGY STAR Minimum)	\$5,750	\$749
AFUE 95%	\$6,073	\$1,072

Early Replacement: The full installation cost is provided in the table above. The assumed deferred cost (after 8 years) of replacing existing equipment with a new baseline unit is assumed to be \$4,627.⁵⁵⁰ This cost should be discounted to present value using the nominal discount rate.

LOADSHAPE

N/A

COINCIDENCE FACTOR

N/A

⁵⁴⁵ ENERGY STAR Program Requirements, Product Specifications for Boilers, version 3.0, effective October 1, 2014 (≥ 90% AFUE for gas-fired and ≥ 87% AFUE for oil-fired)

⁵⁴⁶ Code of Federal Regulations, effective January 15, 2021 (10 CFR 432(e)(3)).

⁵⁴⁷ Appendix 8-F of the Department of Energy Commercial Technical Support Document, Table 8.3.3, federal residential appliance standards.

⁵⁴⁸ Assumed to be one third of effective useful life

⁵⁴⁹ Based on data provided in Technical Support Document: Consumer Boilers. EERE-2014-BT-STD-0036-0021. Department of Energy. April 2022. The total installed cost quoted by DOE was increased by 15% to account for DOE's assumption of an ideal future market (projected from 2022 to 2030) in their development of their technical support documentation. This was an engineering judgment made to better represent real world costs.

⁵⁵⁰ \$4,053 inflated using 1.91% rate.

Algorithm

CALCULATION OF SAVINGS

ELECTRIC ENERGY SAVINGS

N/A

SUMMER COINCIDENT PEAK DEMAND SAVINGS

N/A

FOSSIL FUEL SAVINGS

Time of Sale:

$$\Delta\text{Therms} = (\text{EFLH} * \text{CAP}_{\text{Input}} * (\text{AFUE}_{\text{Eff}} / \text{AFUE}_{\text{Base}} - 1)) / 100,000$$

Early replacement:⁵⁵¹

ΔTherms for remaining life of existing unit (1st 8 years):

$$= (\text{EFLH} * \text{CAP}_{\text{Input}} * (\text{AFUE}_{\text{Eff}} / \text{AFUE}_{\text{Exist}} - 1)) / 100,000$$

ΔTherms for remaining measure life (next 17 years):

$$= (\text{EFLH} * \text{CAP}_{\text{Input}} * (\text{AFUE}_{\text{Eff}} / \text{AFUE}_{\text{Base}} - 1)) / 100,000$$

Where:

$\text{CAP}_{\text{Input}}$ = Gas Boiler input capacity (Btuh)

= Actual

EFLH = Equivalent Full Load Hours for gas heating

Climate Zone (City based upon)	EFLH ⁵⁵²
1 (Rockford)	1022
2 (Chicago)	976
3 (Springfield)	836
4 (Belleville)	645
5 (Marion)	656
Weighted Average ⁵⁵³	
ComEd	978
Ameren	800
Statewide	928

$\text{AFUE}_{\text{Exist}}$ = Existing Boiler Annual Fuel Utilization Efficiency Rating

⁵⁵¹ The two equations are provided to show how savings are determined during the initial phase of the measure (existing to efficient) and the remaining phase (new baseline to efficient). In practice, the screening tools used may either require a First Year savings (using the first equation) and then a “number of years to adjustment” and “savings adjustment” input which would be the (new base to efficient savings)/(existing to efficient savings).

⁵⁵² Full load hours for Chicago, are based on findings in ‘Energy Efficiency / Demand Response Nicor Gas Plan Year 1 (6/1/2011-5/31/2012) Research Report: Furnace Metering Study (August 1, 2013), prepared by Navigant Consulting, Inc. Values for other cities are then calculated by comparing relative HDD at base 60F.

⁵⁵³ Weighting for Ameren is based on gas accounts in each of the heating zones. Weighting for ComEd and Statewide average is based on number of occupied residential housing units in each zone. ComEd is weighted average of Zones 1-2. Alternative program-weighted assumptions can be used if appropriate.

= Use actual AFUE rating where it is possible to measure or reasonably estimate. If using rated efficiencies, derate efficiency value by 1% per year (maximum of 30 years) to account for degradation over time,⁵⁵⁴ or if unknown, assume 61.6 AFUE%.⁵⁵⁵ If unknown value is used, it should not be derated by age.

AFUE_{Base} = Baseline Boiler Annual Fuel Utilization Efficiency Rating

= 84% if implemented in 2022 and beyond

AFUE_{Eff} = Efficient Boiler Annual Fuel Utilization Efficiency Rating

= Actual. If unknown, use defaults dependent on tier as listed below:⁵⁵⁶

Measure Type	AFUE(eff)
ENERGY STAR®	90%
AFUE 90%	92.5%
AFUE 95%	95%

Time of Sale:

For example, a 100,000 Btu/h, 90% AFUE ENERGY STAR boiler purchased and installed near Springfield in 2022:

$$\begin{aligned} \Delta\text{Therms} &= (836 * 100,000 * (0.90/0.84 - 1)) / 100,000 \\ &= 59.7 \text{ Therms} \end{aligned}$$

Early Replacement:

For example, an existing function boiler with unknown efficiency is replaced with a 100,000 Btu/h, 90% AFUE ENERGY STAR boiler purchased and installed in Springfield in 2022:

$$\begin{aligned} \Delta\text{Therms for remaining life of existing unit (1st 8 years):} \\ &= (836 * 100,000 * (0.90/0.616 - 1)) / 100,000 \\ &= 385.4 \text{ Therms} \end{aligned}$$

$$\begin{aligned} \Delta\text{Therms for remaining measure life (next 17 years):} \\ &= (836 * 100,000 * (0.90/0.84 - 1)) / 100,000 \\ &= 59.7 \text{ Therms} \end{aligned}$$

WATER IMPACT DESCRIPTIONS AND CALCULATION

N/A

DEEMED O&M COST ADJUSTMENT CALCULATION

N/A

MEASURE CODE: RS-HVC-GHEB-V12-250101

REVIEW DEADLINE: 1/1/2026

⁵⁵⁴ Justification for degradation factors can be found on page 14 of ‘AIC HVAC Metering Study Memo FINAL 2_28_2018’. Estimate efficiency as (Rated Efficiency * (1-0.01)^{Equipment Age}).

⁵⁵⁵ Average nameplate efficiencies of all Early Replacement qualifying equipment in Ameren PY3-PY4.

⁵⁵⁶ Default values per tier selected based upon the average AFUE value for the tier range except for the top tier where the minimum is used due to proximity to the maximum possible.

5.3.7 Gas High Efficiency Furnace

DESCRIPTION

High efficiency furnace features may include improved heat exchangers and modulating multi-stage burners.

This measure characterizes:

- a) Time of sale:
 - a. The installation of a new high efficiency, gas-fired condensing furnace in a residential location meeting efficiency specifications determined by the program. This could relate to the replacement of an existing unit at the end of its useful life, or the installation of a new system in a new home.

- b) Early Replacement:

Early Replacement determination will be based on meeting the following conditions:

- The existing unit is operational when replaced, or
- The existing unit requires minor repairs (<\$528).⁵⁵⁷
- All other conditions will be considered Time of Sale.

The Baseline AFUE of the existing unit replaced:

- If the AFUE of the existing unit is known, the Baseline AFUE is the actual AFUE value of the unit replaced.
- If the AFUE of the existing unit is unknown, use assumptions in variable list below (AFUE(exist)).
- If the operational status or repair cost of the existing unit is unknown, use time of sale assumptions.

A weighted average early replacement rate is provided for use in programs when the actual baseline early replacement rate is unknown.⁵⁵⁸

Deemed Early Replacement Rates For Furnaces

Replacement Scenario for the Furnace	Deemed Early Replacement Rate
Early Replacement Rate for Furnace-only participants	7%
Early Replacement Rate for a furnace participant when the furnace is the Primary unit in a Combined System Replacement (CSR) project	14%
Early Replacement Rate for a furnace participant when the furnace is the Secondary unit in a CSR project	46%

Verified Quality Installation

This approach uses in-field measurement and interpretation of static pressures, identification and plotting of airflow, airflow measurement, temperature measurement and diagnostics, pressure measurements and duct design, and BTU measurement to ensure that newly installed equipment is operating according to manufacturers’ published potential performance. Installed equipment operating efficiency is largely dependent on the efficiency rating of the

⁵⁵⁷ The Technical Advisory Committee agreed that if the cost of repair is less than 20% of the new baseline replacement cost it can be considered early replacement. Note the non-inflated cost is used as this would be a cost consideration in the program year.

⁵⁵⁸ Based upon research from “Home Energy Efficiency Rebate Program GPY2 Evaluation Report” which outlines early replacement rates for both primary and secondary central air cooling (CAC) and residential furnaces. The unit (furnace or CAC unit) that initially caused the customer to contact a trade ally is defined as the “primary unit”. The furnace or CAC unit that was also replaced but did not initially prompt the customer to contact a trade ally is defined as the “secondary unit”. This evaluation used different criteria for early replacement due to the availability of data after the fact; cost of any repairs < \$550 and age of unit < 20 years. Report presented to Nicor Gas Company February 27, 2014.

equipment, the skill of the installation contractor, the degree to which the equipment has aged or drifted from initial settings, and the system level constraints. When one or more of these key dependencies are operating sub-optimally, the overall efficiency of the equipment is degraded. A Verified Quality Install identifies sub-optimal performance and prescribes a solution during furnace installation.

This measure was developed to be applicable to the following program types: TOS, NC, EREP. If applied to other program types, the measure savings should be verified.

DEFINITION OF EFFICIENT EQUIPMENT

To qualify for this measure the installed equipment must be a residential sized (input energy less than 225,000 Btu/hr) natural gas fired furnace with an Annual Fuel Utilization Efficiency (AFUE) rating exceeding the program requirements. For reference the ENERGY STAR specification is an AFUE rated at or greater than 95% with an ECM motor and input capacity less than 225,000 Btu/hr.⁵⁵⁹

DEFINITION OF BASELINE EQUIPMENT

Time of Sale: The current Federal Standard for gas furnaces is an AFUE rating of 80%. The baseline will be adjusted when the Federal Standard is updated.

Early replacement: The baseline for this measure is the efficiency of the existing equipment for the assumed remaining useful life of the unit and a new baseline 80% AFUE unit for the remainder of the measure life. Consistent with TRM Volume 1 Section 2.3.1 for midstream programs or other cases where the existing condition is unknown, it may be appropriate to apply a deemed percent split of Time of Sale and Early Replacement assumptions based on evaluation results.

DEEMED LIFETIME OF EFFICIENT EQUIPMENT

The expected measure life is assumed to be 20 years.⁵⁶⁰

For early replacement: Remaining life of existing equipment is assumed to be 6 years.⁵⁶¹

DEEMED MEASURE COST

Time of sale: The incremental installed cost (retail equipment cost plus installation cost) for this measure depends on efficiency as listed below:⁵⁶²

AFUE	Installed Cost	Incremental Installed Cost
80%	\$3807	n/a
90%	\$4332	\$526
91%	\$4338	\$531
92%	\$4345	\$538
93%	\$4346	\$540
94%	\$4351	\$544
95%	\$4354	\$547
96%	\$4422	\$615
97%	\$4490	\$683
98%	\$4557	\$751

⁵⁵⁹ ENERGY STAR Program Requirements, Product Specifications for Furnaces, version 4.1, effective February 1, 2013.

⁵⁶⁰ Table 8.3.3 The Technical support documents for federal residential appliance standards.

⁵⁶¹ Assumed to be one third of effective useful life

⁵⁶² Based on data from Technical Support Document: Consumer Furnaces. EERE-2014-BT-STD-0031-0320. Department of Energy. June 2022. The total installed cost quoted by DOE was increased by 15% to account for DOE's assumption of an ideal future market (projected from 2022 to 2029) in their development of their technical support documentation. This was an engineering judgment made to better represent real world costs.

Early Replacement: Actual install costs should be used if available. The deemed full installed cost is provided in the table above. The assumed deferred cost (after 6 years) of replacing existing equipment with a new 80% baseline unit is assumed to be \$2296.⁵⁶³ This cost should be discounted to present value using the nominal discount rate. For furnaces installed in mobile homes, add an extra \$750 to both the full install cost and the deferred baseline cost to account for increased equipment and labor costs associated with this install.⁵⁶⁴

Verified Quality Installation: The additional design and installation work associated with verified quality installation has been estimated to take 1-2 hours (Tim Hanes, ESI). At \$40/hr, VQI adds \$60 to the installed cost.

LOADSHAPE

N/A

COINCIDENCE FACTOR

N/A

Algorithm

CALCULATION OF SAVINGS

ELECTRIC ENERGY SAVINGS

Electrical energy savings from the more fan-efficient (typically using brushless permanent magnet (BPM) blower motor) should also be claimed, please refer to “Furnace Blower Motor” characterization for details.

SUMMER COINCIDENT PEAK DEMAND SAVINGS

If the blower motor is also used for cooling, coincident peak demand savings should also be claimed, please refer to “Furnace Blower Motor” characterization for savings details.

FOSSIL FUEL SAVINGS

Time of Sale:

$$\Delta Therms = \frac{\frac{EFLH * CAPInput}{(1 - Derating_{eff})} * \left(\frac{AFUE(eff) * (1 - Derating(eff))}{AFUE(base) * (1 - Derating(base))} - 1 \right)}{100,000}$$

Early replacement:⁵⁶⁵

ΔTherms for remaining life of existing unit (1st 6 years):

$$= \frac{\frac{EFLH * CAPInput}{(1 - Derating_{eff})} * \left(\frac{AFUE(eff) * (1 - Derating(eff))}{AFUE(exist) * (1 - Derating(base))} - 1 \right)}{100,000}$$

ΔTherms for remaining measure life (next 14 years):

$$= \frac{\frac{EFLH * CAPInput}{(1 - Derating_{eff})} * \left(\frac{AFUE(eff) * (1 - Derating(eff))}{AFUE(base) * (1 - Derating(base))} - 1 \right)}{100,000}$$

Where:

⁵⁶³ \$2641 inflated using 1.91% rate.

⁵⁶⁴ Based on cost review and data provided by Future Energy Enterprises, 5/2022.

⁵⁶⁵ The two equations are provided to show how savings are determined during the initial phase of the measure (existing to efficient) and the remaining phase (new baseline to efficient). In practice, the screening tools used may either require a First Year savings (using the first equation) and then a “number of years to adjustment” and “savings adjustment” input which would be the (new base to efficient savings)/(existing to efficient savings).

CAPInput = Gas Furnace input capacity (Btuh)
 = Actual. If unknown, use the table below:

Eligibility Tier	Input Capacity ⁵⁶⁶
AFUE ≥ 95 (all furnaces, no tiers)	84,305
AFUE ≥ 95 and < 97 tier	84,000
AFUE ≥ 97 tier	87,796

EFLH = Equivalent Full Load Hours for gas heating

Climate Zone (City based upon)	EFLH ⁵⁶⁷
1 (Rockford)	1022
2 (Chicago)	976
3 (Springfield)	836
4 (Belleville)	645
5 (Marion)	656
Weighted Average ⁵⁶⁸	
ComEd	978
Ameren	800
Statewide	928

AFUE(exist) = Existing Furnace Annual Fuel Utilization Efficiency Rating
 = Use actual AFUE rating where it is possible to measure or reasonably estimate. If using rated efficiencies, derate efficiency value by 1% per year (maximum of 30 years) to account for degradation over time,⁵⁶⁹ or if unknown, assume 64.4 AFUE%.⁵⁷⁰ If unknown value is used, it should not be derated by age.

AFUE(base) = Baseline Furnace Annual Fuel Utilization Efficiency Rating
 = 80%⁵⁷¹

AFUE(eff) = Efficient Furnace Annual Fuel Utilization Efficiency Rating
 = Actual. If unknown, use the table below:

Eligibility Tier	AFUE (eff) ⁵⁷²
AFUE ≥ 95 (all furnaces, no tiers)	96.0%

⁵⁶⁶ Average Input Capacity for Northern Illinois, based on analysis of Nicor Gas 2019 Home Energy Efficiency Rebate Program participant tracking data, prepared by Guidehouse, Inc., based on 12,549 furnaces rebated at the 95 AFUE Tier, and 1,103 furnaces rebated at the 97 AFUE Tier. Approximately 10% of tracked input capacities were adjusted by Guidehouse based on verification of manufacturer model numbers. Values for Southern Illinois not available.

⁵⁶⁷ Full load hours for Chicago, are based on findings in ‘Energy Efficiency / Demand Response Nicor Gas Plan Year 1 (6/1/2011-5/31/2012) Research Report: Furnace Metering Study (August 1, 2013), prepared by Navigant Consulting, Inc. Values for other cities are then calculated by comparing relative HDD at base 60F.

⁵⁶⁸ Weighting for Ameren is based on gas accounts in each of the heating zones. Weighting for ComEd and Statewide average is based on number of occupied residential housing units in each zone. ComEd is weighted average of Zones 1-2. Alternative program-weighted assumptions can be used if appropriate.

⁵⁶⁹ Justification for degradation factors can be found on page 14 of ‘AIC HVAC Metering Study Memo FINAL 2_28_2018’. Estimate efficiency as (Rated Efficiency * (1-0.01)^Equipment Age).

⁵⁷⁰ Average nameplate efficiencies of all Early Replacement qualifying equipment in Ameren PY3-PY4.

⁵⁷¹ Code of Federal Regulations, effective November, 2015 (10 CFR 432(e)).

⁵⁷² Average AFUE based on analysis of Nicor Gas 2019 Home Energy Efficiency Rebate Program participant tracking data,

Eligibility Tier	AFUE (eff) ⁵⁷²
AFUE ≥ 95 and < 97 tier	95.9%
AFUE ≥ 97 tier	97.5%

Derating(base) =Baseline furnace AFUE derating

$$= 6.4\%^{573}$$

Derating(eff) =Efficient furnace AFUE derating

=0% if verified quality installation is performed

=6.4% if verified quality installation is not performed or unknown⁵⁷⁴

Time of Sale:

For example, a 95% AFUE, 80,000Btuh furnace purchased and installed with verified quality installation for an existing home near Rockford:

$$\Delta\text{Therms} = ((1022 * 80,000)/(1-0) * (((0.95 * (1-0)) / (0.8 * (1-0.064))) - 1)) / 100000$$

$$= 220 \text{ therms}$$

For example, a 95% AFUE, 80,000 Btuh furnace purchased and installed without verified quality installation for an existing home near Rockford:

$$\Delta\text{Therms} = ((1022 * 80,000)/(1-0.064) * (((0.95 * (1-0.064)) / (0.8 * (1-0.064))) - 1)) / 100000$$

$$= 164 \text{ therms}$$

Early Replacement:

For example, an existing functioning furnace with unknown efficiency is replaced with an 95% AFUE, 80,000 Btuh furnace using quality installation in Rockford:

ΔTherms for remaining life of existing unit (1st 6 years):

$$= ((1022 * 80,000)/(1-0) * (((0.95 * (1-0)) / (0.644 * (1-0.064))) - 1)) / 100000$$

$$= 471 \text{ therms}$$

ΔTherms for remaining measure life (next 14 years):

$$= ((1022 * 80,000)/(1-0) * (((0.95 * (1-0)) / (0.8 * (1-0.064))) - 1)) / 100000$$

$$= 220 \text{ therms}$$

WATER IMPACT DESCRIPTIONS AND CALCULATION

N/A

DEEMED O&M COST ADJUSTMENT CALCULATION

N/A

MEASURE CODE: RS-HVC-GHEF-V14-250101

REVIEW DEADLINE: 1/1/2027

prepared by Guidehouse, Inc., based on 12,549 furnaces rebated at the 95 AFUE Tier, and 1,103 furnaces rebated at the 97 AFUE Tier.

⁵⁷³ Brand, L., Yee, S., and Baker, J. "Improving Gas Furnace Performance: A Field and Laboratory Study at End of Life." Building Technologies Office. National Renewable Energy Laboratory. 2015 accessed September 6th, 2016.

⁵⁷⁴ Ibid

5.3.8 Ground Source Heat Pump

DESCRIPTION

This measure characterizes the installation of a Ground Source Heat Pump under the following scenarios:

- a) New Construction:
 - i. The installation of a new residential sized Ground Source Heat Pump system meeting minimum efficiency standards determined by the program in a new home.
 - ii. Note the baseline in this case should be determined via EM&V and the algorithms are provided to allow savings to be calculated from any baseline condition.
- b) Time of Sale:
 - i. The planned installation of a new residential sized Ground Source Heat Pump system meeting minimum efficiency standards determined by the program to replace an existing system(s) that does not meet the criteria for early replacement described in section c below.
 - ii. Note the baseline in this case is an equivalent replacement system to that which exists currently in the home. Where unknown, the baseline should be determined via EM&V and the algorithms are provided to allow savings to be calculated from any baseline condition. The calculation of savings is dependent on whether an incentive for the installation has been provided by both a gas and electric utility, just an electric utility or just a gas utility.
 - iii. Additional DHW savings are calculated based upon the fuel and efficiency of the existing unit.
- c) Early Replacement/Retrofit:
 - i. The early removal of functioning components of the electric or gas space heating and/or cooling systems from service, prior to the natural end of life, and replacement with a new high efficiency Ground Source Heat Pump system.
 - ii. Note the baseline in this case is the existing equipment being replaced. The calculation of savings is dependent on whether an incentive for the installation has been provided by both a gas and electric utility, just an electric utility or just a gas utility.
 - iii. Additional DHW savings are calculated based upon the fuel and efficiency of the existing unit.
 - iv. Early Replacement determination will be based on meeting the following conditions:
 - The existing unit is operational when replaced, or
 - The existing unit requires minor repairs, defined as costing less than:⁵⁷⁵

Existing System	Maximum repair cost
Air Source Heat Pump	\$276 per ton
Central Air Conditioner	\$190 per ton
Boiler	\$709
Furnace	\$528
Ground Source Heat Pump	<\$249 per ton

 - All other conditions will be considered Time of Sale.
 - v. The Baseline efficiency of the existing unit replaced:
 - Is the actual efficiency value of the unit replaced if known.
 - If the efficiency of the existing unit is unknown, use assumptions in variable list below (SEER2, HSPF2 or AFUE exist).
 - If the operational status or repair cost of the existing unit is unknown use time of sale

⁵⁷⁵ The Technical Advisory Committee agreed that if the cost of repair is less than 20% of the new baseline replacement cost it can be considered early replacement.

assumptions.

This measure was developed to be applicable to the following program types: TOS, NC, EREP. If applied to other program types, the measure savings should be verified.

For ground source heat pump central systems in multifamily buildings, use Volume 2 Commercial and Industrial Measures.

DEFINITION OF EFFICIENT EQUIPMENT

In order for this characterization to apply, the efficient equipment must be a Ground Source Heat Pump unit meeting the minimum efficiency level standards determined by the program effective at the time of installation. For reference, the current ENERGY STAR specifications are detailed below:

ENERGY STAR Requirements (Effective January 1, 2012)

Product Type	Cooling EER	Heating COP
Water-to-air		
Closed Loop	17.1	3.6
Open Loop	21.1	4.1
Water-to-Water		
Closed Loop	16.1	3.1
Open Loop	20.1	3.5
DGX		
DGX-to-Air	16	3.6
DGX-to-Water	15	3.1

The following conversion factors are recommended for use if the efficient equipment is not rated under the new testing procedure.⁵⁷⁶

SEER2 = SEER * X

EER2 = EER * X

HSPF2 = HSPF * X

Where:

X	SEER	EER	HSPF
Ducted	0.95	0.95	0.85

DEFINITION OF BASELINE EQUIPMENT

For these products, baseline equipment includes Air Conditioning, Space Heating and Water Heating.

New Construction:

To calculate savings with an electric baseline, the baseline equipment is assumed to be an Air Source Heat Pump meeting the Federal Standard efficiency level and a Federal Standard electric hot water heater. The Federal Standard efficiency levels for an Air Source Heat Pump are as follows⁵⁷⁷:

⁵⁷⁶ Consortium for Energy Efficiency (CEE), Testing, Testing, M1, 2, 3, Transitioning to New Federal Minimum Standards, CEE Summer Program Meeting, June 10, 2022.

⁵⁷⁷ The 2023 federal standards (10 CFR 430.32(c)(5)) are in terms of an updated metric, depicted as SEER2 and HSPF2 and manufacturers must certify their products meet the standard according to the new test procedure and new metrics. The updated

- Split system heat pump – 14.3 SEER2, 9.4 EER2 and 7.5 HSPF2
- Single-package heat pump – 13.4 SEER2, 8.5 EER2 and 6.7 HSPF2

To calculate savings with a furnace/central AC baseline, the baseline equipment is assumed to be an 80% AFUE Furnace and central AC meeting the Federal Standard efficiency level; 13.4 SEER2, 10.6 EER2⁵⁷⁸. If a gas water heater, the Federal Standard baseline is calculated as follows; 0.6483 – (0.0017 * storage capacity in gallons) for tanks<=55 gallons and 0.7897 – (0.0004 × storage capacity in gallons) for greater than 55 gallon storage water heaters.⁵⁷⁹ For a 40-gallon storage water heater this would be 0.58 EF.

Time of Sale: The baseline for this measure is a new replacement unit of the same system type as the existing unit, meeting the baselines provided below.

Unit Type	Efficiency Standard
ASHP	14.3 SEER2 9.4 EER2, 7.5 HSPF2
Natural Gas or LP Furnace	80% AFUE
Natural Gas or LP Boiler	84% AFUE
Oil Furnace	83% AFUE
Oil Boiler	86% AFUE
Central AC	13.4 SEER2, 10.6 EER2

Early replacement / Retrofit: The baseline for this measure is the efficiency of the *existing* heating, cooling and hot water equipment for the assumed remaining useful life of the existing unit and a new baseline heating and cooling system for the remainder of the measure life (as provided in table above).

DEEMED LIFETIME OF EFFICIENT EQUIPMENT

The expected measure life is assumed to be 25 years.⁵⁸⁰

For early replacement, the remaining life of existing equipment is assumed to be 6 years for ASHP and Central AC, 7 years for furnace, 8 years for boilers and GSHP⁵⁸¹ and 25 years for electric resistance.⁵⁸²

DEEMED MEASURE COST

New Construction and Time of Sale: The actual installed cost of the Ground Source Heat Pump (including any necessary electrical or distribution upgrades required) should be used (default of \$3957 per ton),⁵⁸³ minus the assumed installation cost of the baseline equipment (\$6562 + \$600 per ton for ASHP⁵⁸⁴ or \$2011 for a new baseline

test method as well as the updated energy conservation standards were negotiated under the appliance standards and rulemaking federal advisory committee (ASRAC) in accordance with the Federal Advisory Committee Act (FACA) and the negotiated rulemaking act. An equivalent stringency of these new standards for split system heat pumps are 15 SEER and 8.8 HSPF and for single-package heat pumps are 14 SEER and 8 HSPF, as detailed in: Federal Code of Regulations, Energy Conservation Program: Energy Conservations Standards for residential Central Air Conditioners and Heat Pumps; Confirmation of effective date and compliance date for direct final rule, May 26, 2017, Docket: EERE-2014-BT-STD-0048 (<https://www.regulations.gov/document/EERE-2014-BT-STD-0048-0200>)

⁵⁷⁸ The Federal Standard does not include an EER requirement. The value provided is based on Opinion Dynamics and Cadmus metering study of Ameren HVAC program participants; See ‘AIC HVAC Metering Study Memo FINAL 2_28_2018’.

⁵⁷⁹ Minimum Federal standard as of 4/16/2015.

⁵⁸⁰ System life of indoor components as per DOE estimate (see ‘Geothermal Heat Pumps Department of Energy’). The ground loop has a much longer life, but the compressor and other mechanical components are the same as an ASHP.

⁵⁸¹ Assumed to be one third of effective useful life of replaced equipment.

⁵⁸² Assume full measure life (16 years) for replacing electric resistance as we would not expect that resistance heat would fail during the lifetime of the efficient measure.

⁵⁸³ Based on data provided in ‘Results of Home geothermal and air source heat pump rebate incentives documented by IL electric cooperatives’.

⁵⁸⁴ Full install ASHP costs are based upon data provided by Ameren. See ‘ASHP Costs_06242022’.

80% AFUE furnace, or \$4053 for a new 84% AFUE boiler,⁵⁸⁵ and \$952 per ton for new baseline Central AC replacement⁵⁸⁶).

Early Replacement: The actual full installation cost of the Ground Source Heat Pump should be used (including any necessary electrical or distribution upgrades required). If the install cost is unknown a default is provided above, however because these assumptions do not include any additional costs that may be required for fuel switch scenarios, these defaults should not be used and actual costs should always be used for fuel switch measures.

The assumed deferred cost (after 8 years) of replacing existing equipment with a new baseline unit is assumed to be \$7,527 + \$688 per ton for a new baseline Air Source Heat Pump, or \$2,296 for a new baseline 80% AFUE furnace, or \$4,627 for a new 84% AFUE boiler, and \$1,047 per ton for new baseline Central AC replacement.⁵⁸⁷ This future cost should be discounted to present value using the nominal societal discount rate.

LOADSHAPE

- Loadshape R10 - Residential Electric Heating and Cooling (if replacing gas heat and central AC)⁵⁸⁸
- Loadshape R09 - Residential Electric Space Heat (if replacing electric heat with no cooling)
- Loadshape R10 - Residential Electric Heating and Cooling (if replacing ASHP)

Note for purpose of cost effectiveness screening a fuel switch scenario, the heating kWh increase and cooling kWh decrease should be calculated separately such that the appropriate loadshape (i.e., Loadshape R09 - Residential Electric Space Heat and Loadshape R08 – Residential Cooling respectively) can be applied.

COINCIDENCE FACTOR

The summer peak coincidence factor for cooling is provided in two different ways below. The first is used to estimate peak savings during the utility peak hour and is most indicative of actual peak benefits, and the second represents the *average* savings over the defined summer peak period and is presented so that savings can be bid into PJM’s capacity market.

$$CF_{SSP} = \text{Summer System Peak Coincidence Factor for Heat Pumps (during utility peak hour)}$$

$$= 72\%^{589}$$

$$CF_{PJM} = \text{PJM Summer Peak Coincidence Factor for Heat Pumps (average during PJM peak period)}$$

$$= 46.6\%^{590}$$

Algorithm

CALCULATION OF SAVINGS

ELECTRIC ENERGY SAVINGS AND FOSSIL FUEL SAVINGS

Non-fuel switch measures:

$$\Delta kWh = [\text{Cooling savings}] + [\text{Heating savings}] + [\text{DHW savings}]$$

$$= [\text{FLHcool} * \text{Capacity_cooling} * (1/\text{SEER2}_{\text{base}} - 1/\text{EER2}_{\text{PL}})/1000] + [\text{HeatLoad} * (1/\text{HSPF2}_{\text{base}} - 1/(\text{COP}_{\text{PL}} * 3.412))/1000] + [\text{ElecDHW} * \% \text{DHWDisplaced} * ((1/\text{EF}_{\text{ELEC}} * \text{GPD} * \text{Household}$$

⁵⁸⁵ Furnace and boiler costs are based on data provided in Appendix E of the Appliance Standards Technical Support Documents including equipment cost and installation labor.

⁵⁸⁶ Based on 3 ton initial cost estimate for a conventional unit from ENERGY STAR Central AC calculator.

⁵⁸⁷ All baseline replacement costs are consistent with their respective measures and include inflation rate of 1.91%.

⁵⁸⁸ The baseline for calculating electric savings is an Air Source Heat Pump.

⁵⁸⁹ Based on analysis of metering results from 24 heat pumps in Ameren Illinois service territory in PY5 coincident with AIC’s 2010 system peak; ‘Impact and Process Evaluation of Ameren Illinois Company’s Residential HVAC Program (PY5)’.

⁵⁹⁰ Based on analysis of Itron eShape data for Missouri, calibrated to Illinois loads, supplied by Ameren. The average AC load over the PJM peak period (1-5pm, M-F, June through August) is divided by the maximum AC load during the year.

$$* 365.25 * \gamma_{Water} * (T_{OUT} - T_{IN}) * 1.0) / 3412]$$

Fuel switch measures:

Fuel switch measures must produce positive total lifecycle energy savings (i.e., reduction in Btus at the premises) in order to qualify. This is determined as follows (note for early replacement measures the lifetime savings should be calculated by calculating savings for the remaining useful life of the existing equipment and for the remaining measure life):

$$\begin{aligned} \text{SiteEnergySavings (MMBTUs)} &= \text{FuelSwitchSavings} + \text{NonFuelSwitchSavings} \\ \text{FuelSwitchSavings} &= \text{GasHeatReplaced} - \text{GSHPSiteHeatConsumed} \\ \text{NonFuelSwitchSavings} &= \text{FurnaceFanSavings} + \text{GSHPSiteCoolingImpact} + \text{GSHPSiteWaterImpact} \\ \\ \text{GasHeatReplaced} &= [(\text{HeatLoad} * 1/\text{AFUE}_{base}) / 1,000,000] \\ \text{FurnaceFanSavings} &= (\text{FurnaceFlag} * \text{HeatLoad} * 1/\text{AFUE}_{base} * F_e) / 1,000,000 \\ \text{GSHPSiteHeatConsumed} &= [\text{HeatLoad} * (1/(\text{COP}_{PL} * 3.412))/1000] * 3412) / 1,000,000 \\ \text{GSHPSiteCoolingImpact} &= [\text{FLH}_{cool} * \text{Capacity}_{GSHPcool} * (1/\text{SEER}_{2base} - 1/\text{EER}_{2PL})/1000] * 3412) / 1,000,000 \\ \text{GSHPSiteWaterImpact}_{Gas} &= (\%DHWD\text{Displaced} * (1/\text{EF}_{Gas} * \text{GPD} * \text{Household} * 365.25 * \gamma_{Water} * (T_{OUT} - T_{IN}) * 1.0)) / 1,000,000) \\ \text{GSHPSiteWaterImpact}_{Electric} &= (\%DHWD\text{Displaced} * (1/\text{EF}_{Elec} * \text{GPD} * \text{Household} * 365.25 * \gamma_{Water} * (T_{OUT} - T_{IN}) * 1.0)) / 1,000,000 \end{aligned}$$

If SiteEnergySavings calculated above is positive, the measure is eligible.

The appropriate savings claim is dependent on which utilities are supporting the measure as provided in a table below:

Measure supported by:	Electric Utility claims (kWh):	Gas Utility claims (therms):
Electric utility only	SiteEnergySavings * 1,000,000/3,412	N/A
Electric and gas utility (Note utilities may make alternative agreements to how savings are allocated as long as total MMBtu savings remains the same).	%IncentiveElectric * SiteEnergySavings * 1,000,000/3,412	%IncentiveGas * SiteEnergySavings * 10
Gas utility only	N/A	SiteEnergySavings * 10

Note for Early Replacement measures, the efficiency and Fe terms of the existing unit should be used for the remaining useful life of the existing equipment (6 years for ASHP and Central AC, 6 years for furnace, 8 years for boilers or GSHP, 15 years for electric resistance), and the efficiency and Fe terms for a new baseline unit should be used for the remaining years of the measure. See assumptions below.

Where:

$$\text{FLH}_{cool} = \text{Full load cooling hours}$$

Dependent on location as below:⁵⁹¹

Climate Zone (City based upon)	FLHcool Single Family	FLHcool Multifamily	FLH_cooling (weatherized multifamily) ⁵⁹²
1 (Rockford)	547	499	320
2 (Chicago)	709	629	403
3 (Springfield)	779	707	453
4 (Belleville)	1082	982	630
5 (Marion)	956	868	557
Weighted Average ⁵⁹³			
ComEd	676	603	386
Ameren	875	791	507
Statewide	731	655	420

Use Multifamily if: Building meets utility’s definition for multifamily and system serves single unit. For residential sized systems serving 2 or more units, assume single family hours. For central systems use Volume 2 Commercial and Industrial Measures.

Capacity_GSHPcool = Cooling Output Capacity of Ground Source Heat Pump (Btu/hr)
= Actual (1 ton = 12,000Btu/hr)

SEER2base = SEER2 Efficiency of baseline unit. For early replacment measures, the actual SEER/SEER2 rating where it is possible to measure or reasonably estimate should be used for the remaining useful life of the existing equipment (6 years for ASHP and Central AC, 8 years for GSHP). If using rated efficiencies, derate efficiency value by 1% per year (maximum of 30 years) to account for degradation over time,⁵⁹⁴ or if unknown assume default provided below. If unknown value is used, it should not be derated by age.

Baseline/Existing Cooling System	SEER2base		
	Early Replacement (Remaining useful life of existing equipment)	Early Replacement (Remaining measure life)	Time of Sale or New Construction
Air Source Heat Pump	9.2 SEER2 ⁵⁹⁵	14.3 SEER2 ⁵⁹⁶	
Ground Source Heat Pump	13.4 SEER2 ⁵⁹⁷	14.3 SEER2	

⁵⁹¹ Based on Full Load Hours from ENERGY STAR with adjustments made in a Navigant Evaluation, other cities were scaled using those results and CDD. There is a county mapping table in Volume 1, Section 3.7 providing the appropriate city to use for each county of Illinois. During update cycle for version v.12, applied percent change of CDD65, NCEI Annual Normals from 30 yr data set (1981-2010) to more recent 15 yr data (2006-2020) to all FLHcool values.

⁵⁹² *All-Electric Homes PY6 Metering Results: Multifamily HVAC Systems*, Cadmus, October 2015. The multifamily units within this study had undergone significant shell improvements (air sealing and insulation) and therefore this set of assumptions is only appropriate for units that have recently participated in a weatherization or other shell program. Note that the FLHcool where recalculated based on existing efficiencies consistent with the TRM rather than from the metering study.

⁵⁹³ Weighting for Ameren is based on electric accounts in each of the cooling zones. Weighting for ComEd and Statewide average is based on number of occupied residential housing units in each zone. ComEd is weighted average of Zones 1-2. Alternative program-weighted assumptions can be used if appropriate.

⁵⁹⁴ Justification for degradation factors can be found on page 14 of ‘AIC HVAC Metering Study Memo FINAL 2_28_2018’. Estimate efficiency as (Rated Efficiency * (1-0.01)^Equipment Age).

⁵⁹⁵ Based on Opinion Dynamics and Cadmus metering study of Ameren HVAC program participants; See ‘AIC HVAC Metering Study Memo FINAL 2_28_2018’, converted to SEER2.

⁵⁹⁶ Minimum Federal Standard as of 1/1/2023

⁵⁹⁷ Estimate of existing GSHP efficiency is based converting 12 EER (estimate based upon Navigant, 2018 “EIA – Technology Forecast Updates – Residential and Commercial Building Technologies – Reference Case”) to SEER. Converted to SEER2.

Baseline/Existing Cooling System	SEER2base		
	Early Replacement (Remaining useful life of existing equipment)	Early Replacement (Remaining measure life)	Time of Sale or New Construction
Central AC	9.2 SEER2 ⁵⁹⁸	13.4 SEER2 ⁵⁹⁹	
No central cooling	13.4 SEER2 ⁶⁰⁰	13.4 SEER2	

EER2_{PL} = Part Load EER2 Efficiency of efficient GSHP unit⁶⁰¹
 = Actual installed

HeatLoad = Calculated heat load for the building
 = FLH_GSHPheat * Capacity_GSHPheat

FLH_GSHPheat = Full load hours of heat pump heating
 Dependent on location as below:⁶⁰²

Climate Zone (City based upon)	FLH_heat
1 (Rockford)	1924
2 (Chicago)	1726
3 (Springfield)	1708
4 (Belleville)	1195
5 (Marion)	1270
Weighted Average ⁶⁰³	
ComEd	1766
Ameren	1547
Statewide	1700

Capacity_GSHPheat = Heating Output Capacity of Ground Source Heat Pump (Btu/hr)
 = Actual (1 ton = 12,000Btu/hr)

HSPF2_{base} = Heating Seasonal Performance Factor of baseline heating system (kBtu/kWh), converted to HSPF2 if rating is in HSPF. For early replacement measures, use actual HSPF/HSPF2 rating where it is possible to measure or reasonably estimate for the remaining useful life of the existing equipment (6 years for ASHP, 8 years for GSHP or 15 years for electric resistance). If using rated efficiencies, derate efficiency value by 1% per year (maximum

⁵⁹⁸ Based on Opinion Dynamics and Cadmus metering study of Ameren HVAC program participants; See 'AIC HVAC Metering Study Memo FINAL 2_28_2018' Converted to SEER2.

⁵⁹⁹ Minimum Federal Standard; Federal Register, Vol. 66, No. 14, Monday, January 22, 2001/Rules and Regulations, p. 7170-7200.

⁶⁰⁰ Assumes that the decision to replace existing systems includes desire to add cooling.

⁶⁰¹ As per conversations with David Buss territory manager for Connor Co, the SEER and COP ratings of an ASHP equate most appropriately with the part load EER and COP of a GSHP.

⁶⁰² Heating EFLH based on ENERGY STAR EFLH for Rockford, Chicago, and Springfield and on NCDC/NOAA HDD for the other two cities. In all cases, the hours were adjusted based on average natural gas heating consumption in IL. There is a county mapping table in Volume 1, Section 3.7 providing the appropriate city to use for each county of Illinois. During update cycle for version v.12, applied percent change of HDD60, NCDC/NCEI Annual Normals from 30 yr data set (1981-2010) to more recent 15 yr data (2006-2020) to all FLHheat values

⁶⁰³ Weighting for Ameren is based on electric heat accounts in each of the heating zones. Weighting for ComEd and Statewide average is based on number of occupied residential housing units in each zone. ComEd is weighted average of Zones 1-2. Alternative program-weighted assumptions can be used if appropriate.

of 30 years) to account for degradation over time,⁶⁰⁴ or if unknown assume default. If unknown value is used, it should not be derated by age.

Baseline/ Existing Heating System	HSPF2_base		
	Early Replacement (Remaining useful life of existing equipment)	Early Replacement (Remaining measure life)	Time of Sale or New Construction
Air Source Heat Pump	4.91 HSPF2 ⁶⁰⁵	7.5 HSPF2 ⁶⁰⁶	
Ground Source Heat Pump	7.5 HSPF2 ⁶⁰⁷	7.5 HSPF2	
Electric Resistance	3.41 HSPF2 ⁶⁰⁸		

COP_{PL} = Part Load Coefficient of Performance of efficient unit⁶⁰⁹
 = Actual Installed

3.412 = Constant to convert the COP of the unit to the Heating Season Performance Factor (HSPF)

ElecDHW = 1 if existing DHW is electrically heated
 = 0 if existing DHW is not electrically heated

%DHWDIsplaced = Percentage of total DHW load that the GSHP will provide
 = Actual if known
 = If unknown and if desuperheater installed, assume 44%⁶¹⁰
 = 0% if no desuperheater installed

EF_{ELEC} = Energy Factor (efficiency) of electric water heater
 = Actual. If unknown or for new construction, assume federal standard:⁶¹¹
 For <=55 gallons: 0.96 – (0.0003 * rated volume in gallons)
 For >55 gallons: 2.057 – (0.00113 * rated volume in gallons)

GPD = Gallons Per Day of hot water use per person
 = 45.5 gallons hot water per day per household/2.59 people per household⁶¹²
 = 17.6

⁶⁰⁴ Justification for degradation factors can be found on page 14 of ‘AIC HVAC Metering Study Memo FINAL 2_28_2018’. Estimate efficiency as (Rated Efficiency * (1-0.01)^Equipment Age).

⁶⁰⁵ Based on Opinion Dynamics and Cadmus metering study of Ameren HVAC program participants; See ‘AIC HVAC Metering Study Memo FINAL 2_28_2018’ Converted to HSPF2.

⁶⁰⁶ Based on Minimum Federal Standard effective 1/1/2023.

⁶⁰⁷ Estimate of existing GSHP efficiency is assumed equivalent to a new baseline ASHP. It is recommended that this value be evaluated and adjusted for a future version.

⁶⁰⁸ Electric resistance has a COP of 1.0 which equals 1/0.293 = 3.41 HSPF.

⁶⁰⁹ As per conversations with David Buss territory manager for Connor Co, the SEER and COP ratings of an ASHP equate most appropriately with the part load EER and COP of a GSHP.

⁶¹⁰ Assumes that the desuperheater can provide two thirds of hot water needs for eight months of the year (2/3 * 2/3 = 44%). Based on input from Doug Dougherty, Geothermal Exchange Organization.

⁶¹¹ Minimum Federal Standard as of 4/1/2015;.

⁶¹² Deoreo, B., and P. Mayer. Residential End Uses of Water Study Update. Forthcoming. ©2015 Water Research Foundation. Reprinted With Permission.

Household = Average number of people per household

Household Unit Type	Household ⁶¹³		
	IQ Participants	Non-IQ Participants	All Participants
Single-Family - Deemed	2.76	2.62	2.67
Multifamily - Deemed	2.3	2.09	2.18
Household type unknown			2.52 ⁶¹⁴
Custom	Actual Occupancy or Number of Bedrooms ⁶¹⁵		

Use Multifamily if: Building meets utility’s definition for multifamily

365.25 = Days per year

γ_{Water} = Specific weight of water
= 8.33 pounds per gallon

T_{OUT} = Tank temperature
= 125°F

T_{IN} = Incoming water temperature from well or municipal system
= 50.7°F⁶¹⁶

1.0 = Heat Capacity of water (1 Btu/lb*°F)

3412 = Conversion from Btu to kWh

AFUEbase = Baseline Annual Fuel Utilization Efficiency Rating. For early replacement measures, use actual AFUE rating where it is possible to measure or reasonably estimate for the remaining useful life of the existing equipment (6 years for furnace, 8 years for boilers). If using rated efficiencies, derate efficiency value by 1% per year (maximum of 30 years) to account for degradation over time,⁶¹⁷ or if unknown assume default. If unknown value is used, it should not be derated by age.

Baseline/ Existing Heating System	AFUEbase		
	Early Replacement (Remaining useful life of existing equipment) ⁶¹⁸	Early Replacement (Remaining measure life)	Time of Sale or New Construction
Furnace	64.4%	80%	80%
Boiler	61.6%	84%	84%

FurnaceFlag = 1 if system replaced is a gas furnace, 0 if not.

F_e = Furnace Fan energy consumption as a percentage of annual fuel consumption

⁶¹³ Assumptions are taken from the draft unadjusted 2024 Baseline Study evaluation data provided in 07/2024 by GDS Associates.

⁶¹⁴ Unknown is based on statewide weighted average of 69% single family and 31% multifamily, based on IL data from 2009 RECS Table HC2.9 Structural and Geographic Characteristics of Homes in Midwest Region, Divisions and States, 2009.

⁶¹⁵ Bedrooms are suitable proxies for household occupancy, and may be preferable to actual occupancy due to turnover rates in residency and non-adult population impacts.

⁶¹⁶ Table 4 in Chen, et. al., “Calculating Average Hot Water Mixes of Residential Plumbing Fixtures”, June 2020, reports a value of 50.7°F for inlet water temperature for U.S. Census Division 3.

⁶¹⁷ Justification for degradation factors can be found on page 14 of ‘AIC HVAC Metering Study Memo FINAL 2_28_2018’. Estimate efficiency as (Rated Efficiency * (1-0.01)^Equipment Age).

⁶¹⁸ Average nameplate efficiencies of all Early Replacement qualifying equipment in Ameren PY3-PY4.

For Early Replacement (1st 6 years) $F_e_Exist = 3.14\%$ ⁶¹⁹

For New Construction, Time of Sale and early replacement (remaining 10 years)

$F_e_New = 1.88\%$ ⁶²⁰

$EF_{GAS\ EXIST}$ = Energy Factor (efficiency) of existing gas water heater

= Actual. If unknown, assume federal standard:⁶²¹

For ≤ 55 gallons: $0.6483 - (0.0017 * \text{storage capacity in gallons})$

For > 55 gallons $0.7897 - (0.0004 * \text{storage capacity in gallons})$

= If tank size unknown, assume 40 gallons and $EF_Baseline$ of 0.58

3412 = Btu per kWh

$\%IncentiveElectric$ = % of total incentive paid by electric utility

= Actual

$\%IncentiveGas$ = % of total incentive paid by gas utility

= Actual

⁶¹⁹ F_e is not one of the AHRI certified ratings provided for residential furnaces, but can be reasonably estimated from a calculation based on the certified values for fuel energy (E_f in MMBtu/yr) and E_{ae} (kWh/yr). An average of a 300 record sample (non-random) out of 1495 was 3.14%. This is, appropriately, ~50% greater than the ENERGY STAR version 3 criteria for 2% F_e . See "Programmable Thermostats Furnace Fan Analysis.xlsx" for reference.

⁶²⁰ New furnaces are required to have ECM fan motors installed. Comparing E_{ae} to E_f for furnaces on the AHRI directory as above, indicates that F_e for new furnaces is on average 1.88%.

⁶²¹ Minimum Federal Standard as of 4/1/2015.

Non Fuel Switch Illustrative Examples

New Construction using ASHP baseline:

For example, a 3-ton unit with Part Load EER2 rating of 19 and Part Load COP of 4.4 with desuperheater is installed with a 50 gallon electric water heater in single family non- IQ house in Springfield:

$$\begin{aligned} \Delta kWh &= [779 * 36,000 * (1/13.4 - 1/19) / 1000] + [1708 * 36,000 * (1/7.5 - 1/(4.4 * 3.412)) / 1000] + [1 * 0.44 * ((1/0.945 * 17.6 * 2.62 * 365.25 * 8.33 * (125-50.7) * 1) / 3412)] \\ &= 617 + 4103 + 1422 \\ &= 6142 kWh \end{aligned}$$

Early Replacement

For example, a 3-ton unit with Part Load EER2 rating of 19 and Part Load COP of 4.4 with desuperheater is installed in single family non-IQ house in Springfield with a 50 gallon electric water heater replacing an existing working Air Source Heat Pump with unknown efficiency ratings:

$$\begin{aligned} \Delta kWh \text{ for remaining life of existing unit (1st 8 years):} \\ &= [779 * 36,000 * (1/9.3 - 1/19) / 1000] + [1708 * 36,000 * (1/6.8 - 1/(4.4 * 3.412)) / 1000] + [0.44 * 1 * ((1/0.945 * 17.6 * 2.62 * 365.25 * 8.33 * (125-50.7) * 1) / 3412)] \\ &= 1540 + 4947 + 1422 \\ &= 7,909 kWh \end{aligned}$$

$$\begin{aligned} \Delta kWh \text{ for remaining measure life (next 17 years):} \\ &= (779 * 36,000 * (1/13.4 - 1/19) / 1000) + [1708 * 36,000 * (1/7.5 - 1/ (4.4 * 3.412)) / 1000] + [0.44 * 1 * ((1/0.945 * 17.6 * 2.62 * 365.25 * 8.33 * (125-50.7) * 1) / 3412)] \\ &= 617 + 4103 + 1422 \\ &= 6142 kWh \end{aligned}$$

Fuel Switch Illustrative Example

[for illustrative purposes 50:50 Incentive is used for joint programs]

New construction using gas furnace and central AC baseline:

For example, a 3-ton unit with Part Load EER2 rating of 19 and Part Load COP of 4.4 in single family non-IQ house in Springfield with a 40 gallon gas water heater is installed in place of a natural gas furnace and 3 ton Central AC unit:

$$\begin{aligned} \text{SiteEnergySavings (MMBTUs)} &= \text{GasHeatReplaced} + \text{FurnaceFanSavings} - \text{GSHPSiteHeatConsumed} + \\ &\quad \text{GSHPSiteCoolingImpact} + \text{GSHPSiteWaterImpact} \\ \text{GasHeatReplaced} &= (\text{HeatLoad} * 1/\text{AFUE}_{\text{base}}) / 1,000,000 \\ &= (1708 * 36,000 * 1/0.8) / 1,000,000 = 76.9 \text{ MMBtu} \\ \text{FurnaceFanSavings} &= (\text{FurnaceFlag} * \text{HeatLoad} * 1/\text{AFUE}_{\text{base}} * F_{e_New}) / 1,000,000 \\ &= (1 * 1708 * 36,000 * 1/0.8 * 0.0188) / 1,000,000 \\ &= 1.4 \text{ MMBtu} \\ \text{GSHPSiteHeatConsumed} &= (\text{HeatLoad} * 1/\text{COP}_{\text{PL}}) / 1,000,000 \\ &= (1708 * 36,000 * 1/4.4) / 1,000,000 = 14.0 \text{ MMBtu} \end{aligned}$$

Continued on next page

Fuel Switch Illustrative Example continued

$$\text{GSHPSiteCoolingImpact} = (\text{FLHcool} * \text{Capacity_GSHPcool} * (1/\text{SEER2}_{\text{base}} - 1/\text{EER2}_{\text{PL}})/1000 * 3412)/1,000,000$$

$$= (779 * 36,000 * (1/13.4 - 1/19) / 1000 * 3412) / 1,000,000 = 2.10 \text{ MMBtu}$$

$$\text{GSHPSiteWaterImpact}_{\text{Gas}} = ((\% \text{DHWD displaced} * ((1/\text{EF}_{\text{Gas}} * \text{GPD} * \text{Household} * 365.25 * \gamma_{\text{Water}} * (\text{T}_{\text{OUT}} - \text{T}_{\text{IN}}) * 1.0) / 1,000,000))$$

$$= (0.44 * (1/0.58 * 17.6 * 2.62 * 365.25 * 8.33 * (125-50.7) * 1)) / 1,000,000 = 7.9 \text{ MMBtu}$$

$$\text{SiteEnergySavings (MMBTUs)} = 76.9 + 1.4 - 14.0 + 2.10 + 7.9 = 74.3 \text{ MMBtu (Measure is eligible)}$$

Savings would be claimed as follows:

Measure supported by:	Electric Utility claims:	Gas Utility claims:
Electric utility only	74.3 * 1,000,000/3412 = 21,776 kWh	N/A
Electric and gas utility	0.5 * 74.3 * 1,000,000/3412 = 10,888 kWh	0.5 * 74.3 * 10 = 372 Therms
Gas utility only	N/A	74.3 * 10 = 743 Therms

SUMMER COINCIDENT PEAK DEMAND SAVINGS

$$\Delta \text{kW} = (\text{Capacity_cooling} * (1/\text{EER2}_{\text{base}} - 1/\text{EER2}_{\text{FL}}))/1000 * \text{CF}$$

Where:

EER2base = Energy Efficiency Ratio 2 of baseline unit (kBtu/kWh). For early replacement measures, the actual EER2 rating where it is possible to measure or reasonably estimate should be used for the remaining useful life of the existing equipment (6 years for ASHP and Central AC). If using rated efficiencies, derate efficiency value by 1% per year (maximum of 30 years) to account for degradation over time.⁶²² If unknown, assume default provided below. If unknown value is used, it should not be derated by age.

Baseline/Existing Cooling System	EER2_base		
	Early Replacement (Remaining useful life of existing equipment)	Early Replacement (Remaining measure life)	Time of Sale or New Construction
Air Source Heat Pump	7.4 EER2 ⁶²³	9.4 EER2 ⁶²⁴	
Ground Source Heat Pump	11.2 EER2	11.2 EER2	
Central AC	7.4 EER2	10.6 EER2	
No central cooling	10.6 EER2 ⁶²⁵	10.6 EER2	

⁶²² Justification for degradation factors can be found on page 14 of 'AIC HVAC Metering Study Memo FINAL 2_28_2018'. Estimate efficiency as (Rated Efficiency * (1-0.01)^{Equipment Age}).

⁶²³ Based on Opinion Dynamics and Cadmus metering study of Ameren HVAC program participants; See 'AIC HVAC Metering Study Memo FINAL 2_28_2018' Converted to EER2.

⁶²⁴ Assumed consistent with the EER2 requirements in the Federal Standard for Southwest standards (in the absence of standards for Northern states).

⁶²⁵ Assumes that the decision to replace existing systems includes desire to add cooling.

EER _{2FL}	= Full Load EER2 Efficiency of ENERGY STAR GSHP unit ⁶²⁶
CF _{SSP}	= Summer System Peak Coincidence Factor for Central A/C (during system peak hour) = 72% ⁶²⁷
CF _{PJM}	= PJM Summer Peak Coincidence Factor for Central A/C (average during peak period) = 46.6% ⁶²⁸

New Construction or Time of Sale:

For example, a 3-ton unit with Full Load EER2 unit rating of 19:

$$\begin{aligned} \Delta kW_{SSP} &= (36,000 * (1/9.4 - 1/19))/1000 * 0.72 \\ &= 0.9 \text{ kW} \end{aligned}$$

$$\begin{aligned} \Delta kW_{PJM} &= (36,000 * (1/9.4 - 1/19))/1000 * 0.466 \\ &= 0.71 \text{ kW} \end{aligned}$$

Early Replacement:

For example, a 3-ton Full Load 19 EER2 unit replaces an existing working Air Source Heat Pump with unknown efficiency ratings in Marion:

ΔkW_{SSP} for remaining life of existing unit (1st 8 years):

$$\begin{aligned} &= (36,000 * (1/7.4 - 1/19))/1000 * 0.72 \\ &= 2.14 \text{ kW} \end{aligned}$$

ΔkW_{SSP} for remaining measure life (next 17 years):

$$\begin{aligned} &= (36,000 * (1/9.4 - 1/19))/1000 * 0.72 \\ &= 1.39 \text{ kW} \end{aligned}$$

ΔkW_{PJM} for remaining life of existing unit (1st 8 years):

$$\begin{aligned} &= (36,000 * (1/7.4 - 1/19))/1000 * 0.466 \\ &= 1.38 \text{ kW} \end{aligned}$$

ΔkW_{PJM} for remaining measure life (next 17 years):

$$\begin{aligned} &= (36,000 * (1/9.4 - 1/19))/1000 * 0.466 \\ &= 0.902 \text{ kW} \end{aligned}$$

FOSSIL FUEL SAVINGS

Calculation provided together with Electric Energy Savings above

WATER IMPACT DESCRIPTIONS AND CALCULATION

N/A

DEEMED O&M COST ADJUSTMENT CALCULATION

N/A

⁶²⁶ As per conversations with David Buss territory manager for Connor Co, the EER rating of an ASHP equate most appropriately with the full load EER of a GSHP.

⁶²⁷ Based on analysis of metering results from 24 heat pumps in Ameren Illinois service territory in PY5 coincident with AIC's 2010 system peak; 'Impact and Process Evaluation of Ameren Illinois Company's Residential HVAC Program (PY5)'.

⁶²⁸ Based on analysis of Itron eShape data for Missouri, calibrated to Illinois loads, supplied by Ameren. The average AC load over the PJM peak period (1-5pm, M-F, June through August) is divided by the maximum AC load during the year.

COST EFFECTIVENESS SCREENING AND LOAD REDUCTION FORECASTING WHEN FUEL SWITCHING

This measure can involve fuel switching from gas to electric.

For the purposes of forecasting load reductions due to fuel switch GSHP projects per Section 16-111.5B, changes in site energy use at the customer’s meter (using ΔkWh algorithm below), customer switching estimates, NTG, and any other adjustment factors deemed appropriate, should be used.

The inputs to cost effectiveness screening should reflect the actual impacts on the electric and fuel consumption at the customer meter and, for fuel switching measures, should therefore reflect the decrease in one fuel and increase in another, as opposed to the single savings value calculated in the “Electric and Fossil Fuel Energy Savings” section above. Therefore in addition to the calculation of savings claimed, the following values should be used to assess the cost effectiveness of the measure. For Early Replacement measures, the efficiency terms of the existing unit should be used for the remaining useful life of the existing equipment (6 years for ASHP and Central AC, 6 years for furnace, 8 years for boilers or GSHP, 15 years for electric resistance), and the efficiency terms for a new baseline unit should be used for the remaining years of the measure.

$$\begin{aligned} \Delta\text{Therms} &= [\text{Heating Consumption Replaced}] + [\text{DHW Savings if gas}] \\ &= [(\text{HeatLoad} * 1/\text{AFUE}_{\text{base}}) / 100,000] + [(1 - \text{ElecDHW}) * \% \text{DHWDisplaced} * (1/ \text{EF}_{\text{GAS EXIST}} * \text{GPD} * \text{Household} * 365.25 * \gamma\text{Water} * (\text{T}_{\text{OUT}} - \text{T}_{\text{IN}}) * 1.0) / 100,000]] \\ \Delta\text{kWh} &= [\text{FurnaceFanSavings}] - [\text{GSHP heating consumption}] + [\text{Cooling savings}] + [\text{DHW savings if electric}] \\ &= [\text{FurnaceFlag} * \text{HeatLoad} * 1/\text{AFUE}_{\text{base}} * F_e * 0.000293] - [(\text{HeatLoad} * (1/\text{COP}_{\text{PL}} * 3.412))/1000] + [(\text{FLHcool} * \text{Capacity}_{\text{GSHPcool}} * (1/\text{SEER}_{2\text{base}} - 1/\text{EER}_{2\text{PL}}))/1000] + [\text{ElecDHW} * \% \text{DHWDisplaced} * ((1/\text{EF}_{\text{ELEC}} * \text{GPD} * \text{Household} * 365.25 * \gamma\text{Water} * (\text{T}_{\text{OUT}} - \text{T}_{\text{IN}}) * 1.0) / 3412)] \end{aligned}$$

Illustrative Example of Cost Effectiveness Inputs for Fuel Switching

For example, a 3-ton unit with Part Load EER2 rating of 19 and Part Load COP of 4.4 in single family non-IQ house in Springfield with a 40-gallon gas water heater replaces an existing working natural gas furnace and 3-ton Central AC unit with unknown efficiency ratings. [Note the calculation provides the annual savings for the first 6 years of the measure life, an additional calculation (not shown) would be required to calculate the annual savings for the remaining life (years 7-25)]:

$$\begin{aligned} \Delta\text{Therms} &= [(\text{HeatLoad} * 1/\text{AFUE}_{\text{exist}}) / 100,000] + [(1 - \text{ElecDHW}) * \% \text{DHWDisplaced} * (1/ \text{EF}_{\text{GAS EXIST}} * \text{GPD} * \text{Household} * 365.25 * \gamma\text{Water} * (\text{T}_{\text{OUT}} - \text{T}_{\text{IN}}) * 1.0) / 100,067]] \\ &= [1708 * 36,000 * 1/0.644] / 100,000 + [((1 - 0) * 0.44 * (1/ 0.58 * 17.6 * 2.62 * 365.25 * 8.33 * (125-54) * 1) / 100,067)] \\ &= 955 + 76 \\ &= 1031 \text{ therms} \\ \Delta\text{kWh} &= [\text{FurnaceFlag} * \text{HeatLoad} * 1/\text{AFUE}_{\text{base}} * F_e_{\text{Exist}} * 0.000293] - [(\text{HeatLoad} * (1/\text{COP}_{\text{PL}} * 3.412))/1000] + [(\text{FLHcool} * \text{Capacity}_{\text{GSHPcool}} * (1/\text{SEER}_{\text{exist}} - 1/\text{EER}_{\text{PL}}))/1000] + [\text{ElecDHW} * \% \text{DHWDisplaced} * (((1/\text{EF}_{\text{ELEC}}) * \text{GPD} * \text{Household} * 365.25 * \gamma\text{Water} * (\text{T}_{\text{OUT}} - \text{T}_{\text{IN}}) * 1.0) / 3412)] \\ &= [1 * 1708 * 3600 * 1/0.644 * 0.0314 * 0.000293] - [(1708 * 36,000 * (1/(4.4 * 3.412)))/ 1000] + [(779 * 36,000 * (1/9.2 - 1/19))/ 1000] + [0 * 0.44 * (((1/0.904) * 17.6 * 2.62 * 365.25 * 8.33 * (125-50.7) * 1)/3412)] \\ &= 88 - 4096 + 1572 + 0 \end{aligned}$$

MEASURE CODE: RS-HVC-GSHP-V15-250101

REVIEW DEADLINE: 1/1/2027

5.3.9 High Efficiency Bathroom Exhaust or Radon Mitigation Fan

DESCRIPTION

This market opportunity measure is split into the purchase of a new bathroom fan for typical usage, meet the need for continuous mechanical ventilation due to reduced air-infiltration from a tighter building shell, and for Radon mitigation. In retrofit projects, existing fans may be too loud, or insufficient in other ways, to be operated as required. This measure assumes fan capacities between 10 and 200 CFM rated at a sound level of less than 2.0 sones at 0.1 inches of water column static pressure, or 50 CFM if used for continuous ventilation, or 120 CFM for Radon mitigation. All eligible installations shall be sized to provide the mechanical ventilation rate indicated by ASHRAE 62.2 or for Radon mitigation.

This measure was developed to be applicable to the following program types: TOS, NC, RF.

If applied to other program types, the measure savings should be verified.

DEFINITION OF EFFICIENT EQUIPMENT

New efficient ENERGY STAR or ENERGY STAR Most Efficient exhaust-only ventilation fan, quiet (< 2.0 sones) operating in accordance with recommended ventilation rate indicated by ASHRAE 62.2 – 2016 or for Radon mitigation. ENERGY STAR specifications (effective October 1, 2015) and 2018 Most Efficient specifications are provided below:

Efficiency Level	Fan Capacity	Minimum Efficacy Level (CFM/Watts)	Maximum Allowable Sound Level (sones)
ENERGY STAR	10 – 89 CFM	2.8	2.0
	90 – 200 CFM	3.5	
ENERGY STAR Most Efficient	All	10	
ENERGY STAR (In-Line)	All	3.8	

DEFINITION OF BASELINE EQUIPMENT

New standard efficiency exhaust-only ventilation fan.

DEEMED LIFETIME OF EFFICIENT EQUIPMENT

The expected measure life is assumed to be 19 years.⁶²⁹

DEEMED MEASURE COST

Incremental cost per installed fan is \$48 for ENERGY STAR qualified fans.⁶³⁰

LOADSHAPE

Loadshape R11 - Residential Ventilation

COINCIDENCE FACTOR

The summer Peak Coincidence Factor is assumed to be 100% because the fan runs continuously.

⁶²⁹ Conservative estimate based upon GDS Associates Measure Life Report “Residential and C&I Lighting and HVAC measures” 25 years for whole-house fans, and 19 for thermostatically-controlled attic fans.

⁶³⁰ VEIC analysis using cost data collected from wholesale and retail vendors.

Algorithm

CALCULATION OF SAVINGS

ELECTRIC ENERGY SAVINGS

$$\Delta kWh = (CFM * (1/\eta_{BASELINE} - 1/\eta_{EFFICIENT})/1000) * \text{Hours}$$

Where:

- CFM = Nominal Capacity of the exhaust fan
= Actual or use defaults provided below
= Assume 50CFM for continuous ventilation⁶³¹
- $\eta_{BASELINE}$ = Average efficacy for baseline fan (CFM/watts)
= See table below
- $\eta_{EFFICIENT}$ = Average efficacy for efficient fan (CFM/watts)
= Actual or use defaults provided below
- Hours = assumed annual run hours,
= 1089 for standard usage⁶³²
= 8766 for continuous ventilation.

Defaults provided below:⁶³³

Application	Min CFM	Max CFM	Average CFM	Base CFM/Watts	ENERGY STAR		ENERGY STAR Most Efficient	
					CFM/Watts	ΔkWh Savings	CFM/Watts	ΔkWh Savings
Standard usage	10	89	71.0	1.7	4.7	28.9	11.9	38.9
	90	200	115.9	2.7	5.4	23.1	14.2	37.8
	Unknown		94.2	2.2	5.1	26.9	13.3	39.4
Continuous usage	N/A		50	1.7	5.0	164.6	11.3	213.8
Continuous usage (Radon)	N/A		120	2.5	5.0	203.2	n/a	n/a

SUMMER COINCIDENT PEAK DEMAND SAVINGS

$$\Delta kW = (CFM * (1/\eta_{BASELINE} - 1/\eta_{EFFICIENT})/1000) * CF$$

Where:

⁶³¹ 50CFM is the closest available fan size to ASHRAE 62.2 Section 4.1 Whole House Ventilation rates based upon typical square footage and bedrooms.

⁶³² Assumed to be consistent with Residential Indoor Lighting hours of use.

⁶³³ Based on review of Bathroom Exhaust Fan product available on CEC Appliance Database, accessed 4/6/2023. See 'CEC-res-vent-fans-4.6.23.xlsx' for more information.

CF = Summer Peak Coincidence Factor
 = 0.135 for standard usage
 = 1.0 for continuous operation
 Other variables as defined above

Application	Min CFM	Max CFM	Average CFM	ENERGY STAR ΔkW Savings	ENERGY STAR Most Efficient ΔkW Savings
Standard usage	10	89	70.6	0.0036	0.0048
	90	200	116.1	0.0029	0.0047
	Unknown		92.4	0.0033	0.0049
Continuous usage	N/A		50	0.0188	0.0244

FOSSIL FUEL SAVINGS

N/A

WATER IMPACT DESCRIPTIONS AND CALCULATION

N/A

DEEMED O&M COST ADJUSTMENT CALCULATION

N/A

MEASURE CODE: RS-HVC-BAFA-V04-250101

REVIEW DEADLINE: 1/1/2029

5.3.10 HVAC Tune Up (Central Air Conditioning or Air Source Heat Pump)

DESCRIPTION

This measure involves the measurement of refrigerant charge levels and airflow over the central air conditioning or heat pump unit coil, correction of any problems found and post-treatment re-measurement. Measurements must be performed with standard industry tools and the results tracked by the efficiency program.

Savings from this measure are developed using a reputable Wisconsin study. It is recommended that future evaluation be conducted in Illinois to generate a more locally appropriate characterization.

This measure was developed to be applicable to the following program types: RF. If applied to other program types, the measure savings should be verified.

For tune-up of central systems in multifamily buildings, use Volume 2 Commercial and Industrial Measures.

DEFINITION OF EFFICIENT EQUIPMENT

N/A

DEFINITION OF BASELINE EQUIPMENT

This measure assumes that the existing unit being maintained is either a residential central air conditioning unit or an air source heat pump that has not been serviced for at least 3 years.

DEEMED LIFETIME OF EFFICIENT EQUIPMENT

The measure life is assumed to be 3 years.⁶³⁴

DEEMED MEASURE COST

If the implementation mechanism involves delivering and paying for the tune up service, the actual cost should be used. If however the customer is provided a rebate and the program relies on private contractors performing the work, the measure cost should be assumed to be \$225.⁶³⁵

LOADSHAPE

Loadshape R08 - Residential Cooling

COINCIDENCE FACTOR

The summer peak coincidence factor for cooling is provided in two different ways below. The first is used to estimate peak savings during the utility peak hour and is most indicative of actual peak benefits, and the second represents the *average* savings over the defined summer peak period and is presented so that savings can be bid into PJM's capacity market.

CF_{SSP} = Summer System Peak Coincidence Factor for Central A/C (during utility peak hour)
= 68%⁶³⁶

CF_{SSP} = Summer System Peak Coincidence Factor for Heat Pumps (during system peak hour)
= 72%⁶³⁷

⁶³⁴ Based on DEER 2014 EUL Table for "Clean Condenser Coils – Residential" and "Refrigerant Charge – Residential".

⁶³⁵ Based on personal communication with HVAC efficiency program consultant Buck Taylor or Roltay Inc., 6/21/10, who estimated the cost of tune up at \$125 to \$225, depending on the market and the implementation details. The average value of \$175 has been increased by inflation to give an estimate of \$225 in 2021.

⁶³⁶ Based on metering of 24 homes with central AC during PY4 and PY5 in Ameren Illinois service territory.

⁶³⁷ Based on analysis of metering results from 24 heat pumps in Ameren Illinois service territory in PY5 coincident with AIC's 2010 system peak; 'Impact and Process Evaluation of Ameren Illinois Company's Residential HVAC Program (PY5)'.

$$CF_{PJM} = \text{PJM Summer Peak Coincidence Factor for Central A/C (average during PJM peak period)}$$

$$= 46.6\%^{638}$$

Algorithm

CALCULATION OF SAVINGS

ELECTRIC ENERGY SAVINGS

$$\Delta kWh_{\text{Central AC}} = (\text{FLHcool} * \text{Capacity_cooling} * (1/\text{SEER2}_{\text{CAC}}))/1,000 * \text{MFe}$$

$$\Delta kWh_{\text{Air Source Heat Pump}} = ((\text{FLHcool} * \text{Capacity_cooling} * (1/\text{SEER2}_{\text{ASHP}}))/1,000 * \text{MFe}) + (\text{FLHheat} * \text{Capacity_heating} * (1/\text{HSPF2}_{\text{ASHP}}))/1,000 * \text{MFe}$$

Where:

FLHcool = Full load cooling hours
 Dependent on location as below:⁶³⁹

Climate Zone (City based upon)	FLHcool Single Family	FLHcool Multifamily
1 (Rockford)	547	499
2 (Chicago)	709	629
3 (Springfield)	779	707
4 (Belleville)	1,082	982
5 (Marion)	956	868
Weighted Average ⁶⁴⁰		
ComEd	676	603
Ameren	875	791
Statewide	731	655

Use Multifamily if: Building meets utility’s definition for multifamily and system serves single unit. For residential sized systems serving 2 or more units, assume single family hours. For central systems use Volume 2 Commercial and Industrial Measures.

Capacity_cooling = Cooling capacity of equipment in Btu/hr (note 1 ton = 12,000 Btu/hr)

= Actual

SEER2_{CAC} = SEER2 Efficiency of existing central air conditioning unit receiving maintenance

= Actual. If unknown assume 9.5 SEER2 ⁶⁴¹

MFe = Maintenance energy savings factor

= 0.05⁶⁴²

⁶³⁸ Based on analysis of Itron eShape data for Missouri, calibrated to Illinois loads, supplied by Ameren. The average AC load over the PJM peak period (1-5pm, M-F, June through August) is divided by the maximum AC load during the year.

⁶³⁹ Based on Full Load Hours from ENERGY STAR with adjustments made in a Navigant Evaluation, other cities were scaled using those results and CDD. There is a county mapping table in Volume 1, Section 3.7 providing the appropriate city to use for each county of Illinois.

⁶⁴⁰ Weighting for Ameren is based on electric accounts in each of the cooling zones. Weighting for ComEd and Statewide average is based on number of occupied residential housing units in each zone. ComEd is weighted average of Zones 1-2. Alternative program-weighted assumptions can be used if appropriate.

⁶⁴¹ Use actual SEER2 rating where it is possible to measure or reasonably estimate. Unknown default of 9.5 SEER2 is a VEIC estimate of existing unit efficiency, based on minimum federal standard between the years of 1992 and 2006, converted to SEER2.

SEER2_{ASHP} = SEER2 Efficiency of existing air source heat pump unit receiving maintenance
 = Actual. If unknown assume 9.5 SEER2 ⁶⁴³

FLH_{heat} = Full load heating hours
 Dependent on location:⁶⁴⁴

Climate Zone (City based upon)	FLH _{heat}
1 (Rockford)	1924
2 (Chicago)	1726
3 (Springfield)	1708
4 (Belleville)	1195
5 (Marion)	1270
Weighted Average ⁶⁴⁵	
ComEd	1766
Ameren	1547
Statewide	1700

Capacity_{heating} = Heating capacity of equipment in Btu/hr (note 1 ton = 12,000 Btu/hr)
 = Actual

HSPF2_{ASHP} = Heating Season Performance Factor of existing air source heat pump unit receiving maintenance
 = Actual. If unknown assume 5.8 HSPF2 ⁶⁴⁶

For example, maintenance of a 3-ton, SEER2 10 air conditioning unit in a single family house in Springfield:

$$\Delta kWh_{CAC} = (779 * 36,000 * (1/10))/1,000 * 0.05$$

$$= 140 \text{ kWh}$$

For example, maintenance of a 3-ton, SEER2 10, HSPF2 6.8 air source heat pump unit in a single family house in Springfield:

$$\Delta kWh_{ASHP} = ((779 * 36,000 * (1/10))/1,000 * 0.05) + (1,708 * 36,000 * (1/6.8))/1,000 * 0.05$$

$$= 592 \text{ kWh}$$

⁶⁴³ Use actual SEER2 rating where it is possible to measure or reasonably estimate. Unknown default of 9.5 SEER2 is a VEIC estimate of existing unit efficiency, based on minimum federal standard between the years of 1992 and 2006, converted to SEER2.

⁶⁴⁴ Full load heating hours for heat pumps are provided for Rockford, Chicago and Springfield in the ENERGY STAR Calculator. Estimates for the other locations were calculated based on the FLH to Heating Degree Day (from NCDC) ratio. VEIC consider ENERGY STAR estimates to be high due to oversizing not being adequately addressed. Using average Illinois billing data (from [Illinois Commerce Commission](#)) VEIC estimated the average gas heating load and used this to estimate the average home heating output (using 83% average gas heat efficiency). Dividing this by a typical 36,000 Btu/hr ASHP gives an estimate of average ASHP FLH_{heat} of 1821 hours. We used the ratio of this value to the average of the locations using the ENERGY STAR data (1994 hours) to scale down the ENERGY STAR estimates. There is a county mapping table in Volume 1, Section 3.7 providing the appropriate city to use for each county of Illinois.

⁶⁴⁵ Weighting for Ameren is based on electric heat accounts in each of the heating zones. Weighting for ComEd and Statewide average is based on number of occupied residential housing units in each zone. ComEd is weighted average of Zones 1-2. Alternative program-weighted assumptions can be used if appropriate.

⁶⁴⁶ Use actual HSPF2 rating where it is possible to measure or reasonably estimate. Unknown default of 5.8 HSPF2 is a VEIC estimate based on minimum Federal Standard between 1992 and 2006, converted to HSPF2.

SUMMER COINCIDENT PEAK DEMAND SAVINGS

$$\Delta kW = \text{Capacity}_{\text{cooling}} * (1/\text{EER2})/1,000 * \text{MFd} * \text{CF}$$

Where:

EER2	= EER2 Efficiency of existing unit receiving maintenance in Btu/H/Watts = Calculate using Actual SEER2 = $- 0.02 * \text{SEER2}^2 + 1.12 * \text{SEER2}$ ⁶⁴⁷
MFd	= Maintenance demand savings factor
CF _{SSP}	= Summer System Peak Coincidence Factor for Central A/C (during system peak hour) = 68% ⁶⁴⁸
CF _{SSP}	= Summer System Peak Coincidence Factor for Heat Pumps (during system peak hour) = 72% ⁶⁴⁹
CF _{PJM}	= PJM Summer Peak Coincidence Factor for Central A/C and Heat Pumps (average during peak period) = 46.6% ⁶⁵⁰

For example, maintenance of 3-ton, SEER2 10 (equals EER2 9.2) CAC unit:

$$\begin{aligned} \Delta kW_{\text{SSP}} &= 36,000 * 1/(9.2)/1,000 * 0.02 * 0.68 \\ &= 0.0532 \text{ kW} \\ \Delta kW_{\text{PJM}} &= 36,000 * 1/(9.2)/1,000 * 0.02 * 0.466 \\ &= 0.0365 \text{ kW} \end{aligned}$$

FOSSIL FUEL SAVINGS

N/A

WATER IMPACT DESCRIPTIONS AND CALCULATION

N/A

DEEMED O&M COST ADJUSTMENT CALCULATION

Conservatively not included.

MEASURE CODE: RS-HVC-TUNE-V09-250101

REVIEW DEADLINE: 1/1/2025

⁶⁴⁷ Based on Wassmer, M. (2003). A Component-Based Model for Residential Air Conditioner and Heat Pump Energy Calculations. Masters Thesis, University of Colorado at Boulder. Note this is appropriate for single speed units only.

⁶⁴⁸ Based on metering of 24 homes with central AC during PY4 and PY5 in Ameren Illinois service territory.

⁶⁴⁹ Based on analysis of metering results from 24 heat pumps in Ameren Illinois service territory in PY5 coincident with AIC's 2010 system peak; 'Impact and Process Evaluation of Ameren Illinois Company's Residential HVAC Program (PY5)'.

⁶⁵⁰ Based on analysis of Itron eShape data for Missouri, calibrated to Illinois loads, supplied by Ameren. The average AC load over the PJM peak period (1-5pm, M-F, June through August) is divided by the maximum AC load during the year.

5.3.11 Programmable Thermostats

DESCRIPTION

This measure characterizes the household energy savings from the installation of a new or reprogramming of an existing Programmable Thermostat for reduced heating energy consumption through temperature set-back during unoccupied or reduced demand times. Because a literature review was not conclusive in providing a defensible source of prescriptive cooling savings from programmable thermostats, cooling savings from programmable thermostats are assumed to be zero for this version of the measure. It is not appropriate to assume a similar pattern of savings from setting a thermostat down during the heating season and up during the cooling season. Since energy savings are applicable at the household level, savings should only be claimed for one thermostat of any type (i.e., one programmable thermostat or one advanced thermostat), installation of multiple thermostats per home does not accrue additional savings.

This measure was developed to be applicable to the following program types: TOS, NC, RF, DI.

If applied to other program types, the measure savings should be verified.

DEFINITION OF EFFICIENT EQUIPMENT

The criteria for this measure are established by replacement of a manual-only temperature control, with one that has the capability to adjust temperature setpoints according to a schedule without manual intervention. This category of equipment is broad and rapidly advancing in regards to the capability, and usability of the controls and their sophistication in setpoint adjustment and information display, but for the purposes of this characterization, eligibility is perhaps most simply defined by what it is not: a manual only temperature control.

For the thermostat reprogramming measure, the auditor consults with the homeowner to determine an appropriate set back schedule, reprograms the thermostat and educates the homeowner on its appropriate use.

DEFINITION OF BASELINE EQUIPMENT

For new thermostats the baseline is a non-programmable thermostat requiring manual intervention to change temperature setpoint.

For the purpose of thermostat reprogramming, an existing programmable thermostat that an auditor determines is being used in override mode or otherwise effectively being operated like a manual thermostat.

DEEMED LIFETIME OF EFFICIENT EQUIPMENT

The expected measure life of a programmable thermostat is assumed to be 16 years, however concerns over persistence over a population result in the application of a mid-life adjustment to reduce annual savings during the measure lifetime.⁶⁵¹ For reprogramming, the measure life of 2 years is assumed.

DEEMED MEASURE COST

Actual material and labor costs should be used if the implementation method allows. If unknown (e.g., through a retail program) the capital cost for the new installation measure is assumed to be \$30.⁶⁵² The cost for reprogramming is assumed to be \$10 to account for the auditor's time to reprogram and educate the homeowner.

LOADSHAPE

Loadshape R09 - Residential Electric Space Heat

⁶⁵¹ ASHRAE Applications (2003), Section 36, Table 3 provides an estimate of 16 years for the equipment life, however the TAC agreed to reduce by 50% to account for persistence issues. This is applied via a midlife adjustment (see later section) rather than a reduction in the measure life to 8 years.

⁶⁵² Market prices vary significantly in this category, generally increasing with thermostat capability and sophistication. The basic functions required by this measure's eligibility criteria are available on units readily available in the market for the listed price.

COINCIDENCE FACTOR

N/A due to no savings attributable to cooling during the summer peak period.

Algorithm

CALCULATION OF SAVINGS

ELECTRIC ENERGY SAVINGS

$$\Delta kWh^{653} = \%ElectricHeat * Elec_Heating_Consumption * Heating_Reduction * HF * Eff_ISR + (\Delta Therms * F_e * 29.3)$$

Where:

%ElectricHeat = Percentage of heating savings assumed to be electric

Heating fuel	%ElectricHeat
Electric	100%
Natural Gas	0%
Unknown	3% ⁶⁵⁴

Elec_Heating_Consumption

= Estimate of annual household heating consumption for electrically heated homes.⁶⁵⁵ If location and heating type is unknown, assume 15,683 kWh.⁶⁵⁶

Climate Zone (City based upon)	Electric Resistance Elec_Heating_ Consumption (kWh)	Electric Heat Pump Elec_Heating_ Consumption (kWh)
1 (Rockford)	21,748	12,793
2 (Chicago)	20,777	12,222
3 (Springfield)	17,794	10,467
4 (Belleville)	13,726	8,074
5 (Marion)	13,970	8,218
Average	19,749	11,617

Heating_Reduction = Assumed percentage reduction in total household heating energy consumption due to programmable thermostat

⁶⁵³ Note the second part of the algorithm relates to furnace fan savings if the heating system is Natural Gas.

⁶⁵⁴ Value used is based on known PY8 percent of electric heat provided by Navigant as part of the ongoing evaluation work source: "Slide 21: May 22, 2018, Second Addendum IL TRM Advanced Thermostat Cooling Savings Evaluation"

⁶⁵⁵ Values in table are based on converting an average household heating load (834 therms) for Chicago based on 'Table E-1, Energy Efficiency/Demand Response Nicor Gas Plan Year 1: Research Report: Furnace Metering Study, Draft, Navigant, August 1 2013 to an electric heat load (divide by 0.03412) to electric resistance and ASHP heat load (resistance load reduced by 15% to account for distribution losses that occur in furnace heating but not in electric resistance while ASHP heat is assumed to suffer from similar distribution losses) and then to electric consumption assuming efficiencies of 100% for resistance and 200% for HP (see 'Household Heating Load Summary Calculations_08222018.xls'). Finally these values were adjusted to a statewide average using relative HDD assumptions to adjust for the evaluation results focus on northern region. Values for individual cities are then calculated by comparing average HDD to the individual city's HDD.

⁶⁵⁶ Assumption that 1/2 of electrically heated homes have electric resistance and 1/2 have Heat Pump, based on 2010 Residential Energy Consumption Survey for Illinois.

= 6.2%⁶⁵⁷

HF = Household factor, to adjust heating consumption for non-single-family households.

Household Type	HF
Single-Family	100%
Mobile home	83% ⁶⁵⁸
Multifamily	65% ⁶⁵⁹
Unknown	96.5% ⁶⁶⁰
Actual	Custom ⁶⁶¹

Use Multifamily if: Building meets utility’s definition for multifamily and system serves single unit. For residential sized systems serving 2 or more units, assume single family hours. For central systems use Volume 2 Commercial and Industrial Measures.

Eff_ISR = Effective In-Service Rate, the percentage of thermostats installed and programmed effectively

Program Delivery	Eff_ISR
Direct Install	100%
Other, or unknown	56% ⁶⁶²

ΔTherms = Therm savings if Natural Gas heating system
 = See calculation in Fossil Fuel section below

F_e = Furnace Fan energy consumption as a percentage of annual fuel consumption
 = 3.14%⁶⁶³

29.3 = kWh per therm

⁶⁵⁷ The savings from programmable thermostats are highly susceptible to many factors best addressed, so far for this category, by a study that controlled for the most significant issues with a very large sample size. To the extent that the treatment group is representative of the program participants for IL, this value is suitable. Higher and lower values would be justified based upon clear dissimilarities due to program and product attributes. Future evaluation work should assess program specific impacts associated with penetration rates, baseline levels, persistence, and other factors which this value represents.

⁶⁵⁸ Since mobile homes are similar to Multifamily homes with respect to conditioned floor area but to single-family homes with respect to exposure (i.e., all four wall orientations are adjacent to the outside), this factor is estimated as an average of the single family and multifamily household factors.

⁶⁵⁹ Multifamily household heating consumption relative to single-family households is affected by overall household square footage and exposure to the exterior. This 65% factor is applied to MF homes based on professional judgment that average household size, and heat loads of MF households are smaller than single-family homes

⁶⁶⁰ When Household type is unknown, a value of 96.5% may be used as a weighted average of 90% SF and 10% MF (96.5% = 100%*90% + 65%*10%) based on a Navigant evaluation of PY8 participants in ComEd’s advanced thermostat program.

⁶⁶¹ Program-specific household factors may be utilized on the basis of sufficiently validated program evaluations.

⁶⁶²“Programmable Thermostats. Report to KeySpan Energy Delivery on Energy Savings and Cost Effectiveness,” GDS Associates, Marietta, GA. 2002GDS

⁶⁶³ F_e is not one of the AHRI certified ratings provided for residential furnaces, but can be reasonably estimated from a calculation based on the certified values for fuel energy (Ef in MMBtu/yr) and Eae (kWh/yr). An average of a 300 record sample (non-random) out of 1495 was 3.14%. This is, appropriately, ~50% greater than the ENERGY STAR version 3 criteria for 2% F_e. See “Programmable Thermostats Furnace Fan Analysis.xlsx” for reference.

For example, a programmable thermostat direct-installed in an electric resistance heated, single-family home in Springfield:

$$\begin{aligned} \Delta\text{kWh} &= 1 * 17,794 * 0.062 * 100\% * 100\% + (0 * 0.0314 * 29.3) \\ &= 1,103 \text{ kWh} \end{aligned}$$

SUMMER COINCIDENT PEAK DEMAND SAVINGS

N/A due to no savings from cooling during the summer peak period.

NATURAL GAS ENERGY SAVINGS

$$\Delta\text{Therms} = \%FossilHeat * Gas_Heating_Consumption * Heating_Reduction * HF * Eff_ISR$$

Where:

$\%FossilHeat$ = Percentage of heating savings assumed to be Natural Gas

Heating fuel	$\%FossilHeat$
Electric	0%
Natural Gas	100%
Unknown	97% ⁶⁶⁴

$Gas_Heating_Consumption$

= Estimate of annual household heating consumption for gas heated single-family homes. If location is unknown, assume the average below:⁶⁶⁵

Climate Zone (City based upon)	$Gas_Heating_Consumption$ (therms)
1 (Rockford)	1,052
2 (Chicago)	1,005
3 (Springfield)	861
4 (Belleville)	664
5 (Marion)	676
Average	955

For example, a programmable thermostat directly-installed in a gas heated single-family home in Chicago:

$$\begin{aligned} \Delta\text{Therms} &= 1.0 * 1005 * 0.062 * 100\% * 100\% \\ &= 62.3 \text{ therms} \end{aligned}$$

Mid-Life Baseline Adjustment

⁶⁶⁴ Value used is based on known PY8 percent of electric heat provided by Navigant as part of the ongoing evaluation work source: "Slide 21: May 22, 2018, Second Addendum IL TRM Advanced Thermostat Cooling Savings Evaluation"

⁶⁶⁵ Values are based on adjusting the average household heating load (834 therms) for Chicago based on 'Table E-1, Energy Efficiency / Demand Response Nicor Gas Plan Year 1, Research Report: Furnace Metering Study', divided by standard assumption of existing unit efficiency of 83% (estimate based on 24% of furnaces purchased in Illinois were condensing in 2000 (based on data from GAMA, provided to Department of Energy), assuming typical efficiencies: $(0.24 * 0.92) + (0.76 * 0.8) = 0.83$) to give 1005 therms. This Chicago value was then adjusted to a statewide average using relative HDD assumptions to adjust for the evaluation results focus on northern region. Values for individual cities are then calculated by comparing average HDD to the individual city's HDD.

Due to concerns that across a population the savings for programmable thermostats are likely to decline through the technical lifetime of the thermostat,⁶⁶⁶ a mid-life adjustment should be applied. The mid-life adjustment should be applied in year 6 (i.e., after five years of full savings) and is calculated as 28%. This results in a consistent lifetime savings as applying a 50% reduction to the technical lifetime. This adjustment should be applied to both electric and therm heating savings.

WATER IMPACT DESCRIPTIONS AND CALCULATION

N/A

DEEMED O&M COST ADJUSTMENT CALCULATION

N/A

MEASURE CODE: RS-HVC-PROG-V09-250101

REVIEW DEADLINE: 1/1/2029

⁶⁶⁶ This concern is based on consideration of the findings from a number of evaluations, including Sachs et al, *“Field Evaluation of Programmable Thermostats”*, US DOW Building Technologies Program, December 2012, p35; “low proportion of households that ended up using thermostat-enabled energy saving settings”, and Meier et al., *“Usability of residential thermostats: Preliminary investigations”*, Lawrence Berkeley National Laboratory, March 2011, p1; “The majority of occupants operated thermostats manually, rather than relying on their programmable features and almost 90% of respondents reported that they rarely or never adjusted the thermostat to set a weekend or weekday program. Photographs of thermostats were collected in one on-line survey, which revealed that about 20% of the thermostats displayed the wrong time and that about 50% of the respondents set their programmable thermostats on “long term hold” (or its equivalent).”

5.3.12 Ductless Heat Pumps – Removed in v12

Measure now combined with 5.3.1 Air Source Heat Pump (Centrally Ducted and Ductless)

5.3.13 Residential Furnace Tune-Up

DESCRIPTION

This measure is for a natural gas Residential furnace that provides space heating. The tune-up will improve furnace performance by inspecting, cleaning and adjusting the furnace and appurtenances for correct and efficient operation. Additional savings maybe realized through a complete system tune-up.

This measure was developed to be applicable to the following program types: RF.

If applied to other program types, the measure savings should be verified.

DEFINITION OF EFFICIENT EQUIPMENT

To qualify for this measure an approved technician must complete the tune-up requirements listed below:⁶⁶⁷

- Measure combustion efficiency using an electronic flue gas analyzer
- Check and clean blower assembly and components per manufacturer’s recommendations
- Where applicable Lubricate motor and inspect and replace fan belt if required
- Inspect for gas leaks
- Clean burner per manufacturer’s recommendations and adjust as needed
- Check ignition system and safety systems and clean and adjust as needed
- Check and clean heat exchanger per manufacturer’s recommendations
- Inspect exhaust/flue for proper attachment and operation
- Inspect control box, wiring and controls for proper connections and performance
- Check air filter and clean or replace per manufacturer’s
- Inspect duct work connected to furnace for leaks or blockages
- Measure temperature rise and adjust flow as needed
- Check for correct line and load volts/amps
- Check thermostat operation is per manufacturer’s recommendations(if adjustments made, refer to ‘Residential Programmable Thermostat’ measure for savings estimate)
- Perform Carbon Monoxide test and adjust heating system until results are within standard industry acceptable limits

DEFINITION OF BASELINE EQUIPMENT

The baseline is furnace assumed not to have had a tune-up in the past 3 years.

DEEMED LIFETIME OF EFFICIENT EQUIPMENT

The measure life for the clean and check tune up is 3 years.⁶⁶⁸

DEEMED MEASURE COST

The incremental cost for this measure should be the actual cost of tune up.

DEEMED O&M COST ADJUSTMENTS

There are no expected O&M savings associated with this measure.

⁶⁶⁷ American Standard Maintenance for Indoor Units (see ‘HVAC Maintenance American Standard’)

⁶⁶⁸ Assumed consistent with other tune-up measures.

LOADSHAPE

Loadshape R09 - Residential Electric Space Heat

COINCIDENCE FACTOR

N/A

Algorithms

CALCULATION OF ENERGY SAVINGS

ELECTRIC ENERGY SAVINGS

$$\Delta\text{kWh} = \Delta\text{Therms} * F_e * 29.3$$

Where:

- ΔTherms = as calculated below
- F_e = Furnace Fan energy consumption as a percentage of annual fuel consumption
= 3.14%⁶⁶⁹
- 29.3 = kWh per therm

SUMMER COINCIDENT PEAK DEMAND SAVINGS

N/A

FOSSIL FUEL SAVINGS

$$\Delta\text{Therms} = \frac{(\text{CAPInputPre} * \text{EFLH} * (1/\text{Effbefore} - 1/(\text{Effbefore} + \text{Ei})))}{100,000}$$

Where:

- CAPInputPre = Gas Furnace input capacity pre tune-up (Btuh)
= Measured input capacity from HVAC SAVE
- EFLH = Equivalent Full Load Hours for heating

Climate Zone (City based upon)	EFLH ⁶⁷⁰
1 (Rockford)	1022
2 (Chicago)	976
3 (Springfield)	836
4 (Belleville)	645
5 (Marion)	656
Weighted Average ⁶⁷¹	

⁶⁶⁹ F_e is not one of the AHRI certified ratings provided for residential furnaces, but can be reasonably estimated from a calculation based on the certified values for fuel energy (Ef in MMBtu/yr) and Eae (kWh/yr). An average of a 300 record sample (non-random) out of 1495 was 3.14%. This is, appropriately, ~50% greater than the ENERGY STAR version 3 criteria for 2% F_e . See "Programmable Thermostats Furnace Fan Analysis.xlsx" for reference.

⁶⁷⁰ Full load hours for Chicago, are based on findings in 'Energy Efficiency / Demand Response Nicor Gas Plan Year 1 (6/1/2011-5/31/2012) Research Report: Furnace Metering Study (August 1, 2013), prepared by Navigant Consulting, Inc. Values for other cities are then calculated by comparing relative HDD at base 60F.

⁶⁷¹ Weighting for Ameren is based on gas accounts in each of the heating zones. Weighting for ComEd and Statewide average is based on number of occupied residential housing units in each zone. ComEd is weighted average of Zones 1-2. Alternative program-weighted assumptions can be used if appropriate.

Climate Zone (City based upon)	EFLH ⁶⁷⁰
ComEd	978
Ameren	800
Statewide	928

Effbefore = Efficiency of the furnace before the tune-up
 = Actual

Note: Contractors should select a mid-level firing rate that appropriately represents the average building operating condition over the course of the heating season and take readings at a consistent firing rate for pre and post tune-up.

EI = Efficiency Improvement of the furnace tune-up measure
 = Actual

WATER IMPACT DESCRIPTIONS AND CALCULATION

N/A

DEEMED O&M COST ADJUSTMENT CALCULATION

N/A

MEASURE CODE: RS-HVC-FTUN-V08-240101

REVIEW DEADLINE: 1/1/2025

5.3.14 Boiler Reset Controls

DESCRIPTION

This measure relates to improving system efficiency by adding controls to residential heating boilers to vary the boiler entering water temperature relative to heating load as a function of the outdoor air temperature to save energy. The water can be run a little cooler during fall and spring, and a little hotter during the coldest parts of the winter. A boiler reset control has two temperature sensors - one outside the house and one in the boiler water. As the outdoor temperature goes up and down, the control adjusts the water temperature setting to the lowest setting that is meeting the house heating demand. There are also limits in the controls to keep a boiler from operating outside of its safe performance range.⁶⁷²

This measure was developed to be applicable to the following program types: RF.

DEFINITION OF EFFICIENT EQUIPMENT

Natural gas single family residential customer adding boiler reset controls capable of resetting the boiler supply water temperature in an inverse fashion with outdoor air temperature. The system must be set so that the minimum temperature is not more than 10 degrees above manufacturer’s recommended minimum return temperature. This boiler reset measure is limited to existing condensing boilers serving a single family residence. Boiler reset controls for non-condensing boilers in single family residences should be implemented as a custom measure, and the cost-effectiveness should be confirmed.

DEFINITION OF BASELINE EQUIPMENT

Existing condensing boiler in a single family residential setting without boiler reset controls.

DEEMED LIFETIME OF EFFICIENT EQUIPMENT

The life of this measure is 16 years, which is assumed to be the remaining life of the existing boiler.⁶⁷³

DEEMED MEASURE COST

The cost of this measure is \$612.⁶⁷⁴

LOADSHAPE

NA

COINCIDENCE FACTOR

N/A

Algorithm

⁶⁷² Energy Solutions Center, a consortium of natural gas utilities, equipment manufacturers and vendors, See ‘Boiler Reset Control – NaturalGasEfficiency.org’.

⁶⁷³ This is intentionally longer than the assumptions found in the early replacement residential HVAC measures as the application of boiler reset controls will occur in a variety of homes that will not be targeted for early replacement HVAC systems.

⁶⁷⁴ Nexant. Questar DSM Market Characterization Report. August 9, 2006.

CALCULATION OF ENERGY SAVINGS

ELECTRIC ENERGY SAVINGS

N/A

SUMMER COINCIDENT PEAK DEMAND SAVINGS

NA

FOSSIL FUEL SAVINGS

$$\Delta\text{Therms} = \text{Gas_Boiler_Load} * (1/\text{AFUE}) * \text{Savings Factor}$$

Where:

Gas_Boiler_Load⁶⁷⁵

= Estimate of annual household Load for gas boiler heated single-family homes. If location is unknown, assume the average below.⁶⁷⁶

= or Actual if informed by site-specific load calculations, ACCA Manual J, or equivalent.⁶⁷⁷

Climate Zone (City based upon)	Gas_Boiler Load (therms)
1 (Rockford)	1275
2 (Chicago)	1218
3 (Springfield)	1043
4 (Belleville)	805
5 (Marion)	819
Average	1158

AFUE = Existing Condensing Boiler Annual Fuel Utilization Efficiency Rating

= Actual. If unknown, default to 90%.⁶⁷⁸

SF = Savings Factor, 5%⁶⁷⁹

⁶⁷⁵ Boiler consumption values are informed by an evaluation which did not identify any fraction of heating load due to domestic hot water (DHW) provided by the boiler. Thus these values are an average of both homes with boilers only providing heat, and homes with boilers that also provide DHW. Heating load is used to describe the household heating need, which is equal to (gas heating consumption * AFUE)

⁶⁷⁶ Values are based on household heating consumption values and inferred average AFUE results from Table 3-4, Program Sample Analysis, *Nicor R29 Res Rebate Evaluation Report 092611_REV FINAL to Nicor*. Adjusting to a statewide average using relative HDD values to adjust for the evaluation results focus on northern region. Values for individual cities are then calculated by comparing average HDD to the individual city's HDD.

⁶⁷⁷ The Air Conditioning Contractors of America Manual J, Residential Load Calculation 8th Edition produces equipment sizing loads for Single Family, Multi-single, and Condominiums using input characteristics of the home. A best practice for equipment selection and installation of Heating and Air Conditioning, load calculations should be completed by contractors during the selection process and may be readily available for program data purposes.

⁶⁷⁸ Condensing boilers typically have an AFUE greater than 90%. This is also a consistent assumption with the '5.3.6 High Efficiency Boiler' measure.

⁶⁷⁹ Energy Solutions Center, a consortium of natural gas utilities, equipment manufacturers and vendors. See 'Boiler Reset Control – NaturalGasEfficiency.org'. This savings value is also supported by Cadmus impact evaluation for the Electric and Gas Program Administrators of Massachusetts: Cadmus, Home Energy Services Impact Evaluation, August 2012.

For example, boiler reset controls on a 92.5 AFUE boiler at a household in Rockford, IL

$$\begin{aligned}\Delta\text{Therms} &= 1275 * (1/0.925) * 0.05 \\ &= 69 \text{ Therms}\end{aligned}$$

WATER IMPACT DESCRIPTIONS AND CALCULATION

N/A

DEEMED O&M COST ADJUSTMENT CALCULATION

N/A

MEASURE CODE: RS-HVC-BREC-V04-240101

REVIEW DEADLINE: 1/1/2027

5.3.15 ENERGY STAR Ceiling Fan

DESCRIPTION

A ceiling fan/light unit meeting the efficiency specifications of ENERGY STAR version 4.0 is installed in place of a model meeting the federal standard. ENERGY STAR qualified ceiling fan/light combination units are over 60% more efficient than conventional fan/light units and use improved motors and blade designs.

Due to the savings from this measure being derived from more efficient ventilation and more efficient lighting, and the loadshape and measure life for each component being very different, the savings are split into the component parts and should be claimed together. Lighting savings should be estimated utilizing the 5.5.9 LED Fixtures measure.

This measure was developed to be applicable to the following program types: TOS, NC, RF.

If applied to other program types, the measure savings should be verified.

DEFINITION OF EFFICIENT EQUIPMENT

The efficient equipment is defined as an ENERGY STAR certified ceiling fan with integral CFL or LED bulbs. Upon review of the ENERGY STAR Qualified Products List, it was determined that 91% of ceiling fans with integrated light kits leverage LED lamps; with the remaining 9% using CFLs.⁶⁸⁰ Concurrently, ENERGY STAR criteria require ceiling fans with light kits to provide the consumer with either CFLs or LEDs. In the cases where light kits require screw-base sockets, the efficient lamps have to be included in the packaging of the ceiling fan.

DEFINITION OF BASELINE EQUIPMENT

The baseline equipment is assumed to be a standard fan with efficient incandescent or halogen light bulbs. Production of 100W, standard efficacy incandescent lamps ended in 2012 followed by restrictions on 75W in 2013 and 60W and 40W in 2014, due to the Energy Independence and Security Act of 2007 (EISA). Finally, a provision in the EISA regulations requires that by January 1, 2020, all lamps meet efficiency criteria of at least 45 lumens per watt, in essence making the baseline equivalent to a current day CFL. Therefore the measure life (number of years that savings should be claimed) for the lighting portion of the savings should be reduced once the assumed lifetime of the bulb exceeds 2020. Due to expected delay in clearing retail inventory and to account for the operating life of a halogen incandescent potentially spanning over 2020, this shift is assumed not to occur until 2021.

Effective January 21, 2020, all ceiling fan light kits manufactured after this date must be packaged with lamps to fill all screw-base sockets, further limiting the potential for inefficient light bulbs to be utilized. Additionally, ceiling fan light kits with pin-based sockets for fluorescent lamps must use electronic ballasts. Integrated ceiling fan light kits must adhere to the same lighting efficiency requirements.

DEEMED LIFETIME OF EFFICIENT EQUIPMENT

The fan savings measure life is assumed to be 10 years.⁶⁸¹

The lighting savings measure life is assumed to be 1 year for lighting savings for units installed in 2020 (see 5.5.9 LED Fixtures measure).⁶⁸²

DEEMED MEASURE COST

Incremental cost of a ceiling fan with light kit is \$46.

⁶⁸⁰ ENERGY STAR version 4.0, Product Specification for Residential Ceiling Fans and Ceiling Fan Light Kits, effective June 15, 2018. Qualified Products List data pulled on 5/5/2022.

⁶⁸¹ Lifetime estimate is sourced from the ENERGY STAR Ceiling Fan Savings Calculator.

⁶⁸² Since the replacement baseline bulb from 2020 on will be equivalent to a CFL, no additional savings should be claimed from that point. Due to expected delay in clearing stock from retail outlets and to account for the operating life of a halogen incandescent potentially spanning over 2020, this shift is assumed not to occur until 2021.

Incremental cost of only a ceiling fan is \$30.71.⁶⁸³

LOADSHAPE

R06 - Residential Indoor Lighting

R11 - Residential Ventilation

COINCIDENCE FACTOR

The summer peak coincidence factor for the ventilation savings is assumed to be 30%.⁶⁸⁴

For lighting savings, see 5.5.9 LED Fixtures measure.

Algorithm

CALCULATION OF SAVINGS

ELECTRIC ENERGY SAVINGS

$$\Delta kWh = \Delta kWh_{fan} + \Delta kWh_{Light}$$

$$\Delta kWh_{fan} = [Days * FanHours * ((\%Low_{base} * WattsLow_{base}) + (\%Med_{base} * WattsMed_{base}) + (\%High_{base} * WattsHigh_{base}))/1000] - [Days * FanHours * ((\%Low_{ES} * WattsLow_{ES}) + (\%Med_{ES} * WattsMed_{ES}) + (\%High_{ES} * WattsHigh_{ES}))/1000]$$

$$\Delta kWh_{light} = \text{see 5.5.9 LED Fixtures measure.}$$

Where:⁶⁸⁵

- Days = Days used per year
= Actual. If unknown use 365.25 days/year
- FanHours = Daily Fan “On Hours”
= Actual. If unknown use 3 hours
- %Low_{base} = Percent of time spent at Low speed of baseline
= 40%
- WattsLow_{base} = Fan wattage at Low speed of baseline
= Actual. If unknown use 15 watts
- %Med_{base} = Percent of time spent at Medium speed of baseline
= 40%
- WattsMed_{base} = Fan wattage at Medium speed of baseline

⁶⁸³ The incremental cost of \$46 is sourced from the ENERGY STAR Ceiling Fan Savings Calculator, which is based on a ceiling fan and a light kit. In order to determine the incremental cost of only a ceiling fan, the incremental cost of the lights were factored in and removed accordingly. Through review of the ENERGY STAR Qualified Products List, accessed on October 11, 2018, the average ceiling fan LED light kit had 1.2 lamps, with an average wattage of 11.8W. The comparable baseline wattage, baseline cost, and efficient lamp cost is based on a scaled equivalence from the 5.5.9 LED Fixtures measure.

⁶⁸⁴ Assuming that the CF same as a Room AC. Consistent with coincidence factors found in: RLW Report: Final Report Coincidence Factor Study Residential Room Air Conditioners, June 23, 2008.

⁶⁸⁵ All fan operating conditions and baseline default assumptions are based upon assumptions provided in the ENERGY STAR Ceiling Fan Savings Calculator. The efficient wattages at the low and high speed settings are sourced from the average of available products on the ENERGY STAR Qualified Products List (QPL), as pulled on 5/5/2022. The efficient wattage at the medium speed is interpolated based on the varying speed wattages from the ENERGY STAR version 4.0 specifications. For more information on the QPL data set, please see “Illinois Residential Ceiling Fan Analysis_2022.xlsx”.

- = Actual. If unknown use 34 watts
- $\%High_{base}$ = Percent of time spent at High speed of baseline
= 20%
- $WattsHigh_{base}$ = Fan wattage at High speed of baseline
= Actual. If unknown use 67 watts
- $\%LowES$ = Percent of time spent at Low speed of ENERGY STAR
= 40%
- $WattsLowES$ = Fan wattage at Low speed of ENERGY STAR
= Actual. If unknown use 5 watts
- $\%MedES$ = Percent of time spent at Medium speed of ENERGY STAR
= 40%
- $WattsMedES$ = Fan wattage at Medium speed of ENERGY STAR
= Actual. If unknown use 14 watts
- $\%HighES$ = Percent of time spent at High speed of ENERGY STAR
= 20%
- $WattsHighES$ = Fan wattage at High speed of ENERGY STAR
= Actual. If unknown use 32 watts

For ease of reference, the fan assumptions are provided below in table form:

	Low Speed	Medium Speed	High Speed
Percent of Time at Given Speed	40%	40%	20%
Conventional Unit Wattage	15	34	67
ENERGY STAR Unit Wattage	5	14	32
ΔW	10	20	35

If the lighting $WattsBase$ and $WattsEE$ is unknown, assume the following:⁶⁸⁶

$$WattsBase = 1.2 \times 46.5 = 55.8 \text{ W}$$

$$WattsEE = 1.2 \times 17.3 = 20.1 \text{ W}$$

For example, an ENERGY STAR ceiling fan with one, 22.4W LED lamp as part of its light kit were purchased and installed to replace an existing ceiling fan that was no longer operational, the savings are:

$$\begin{aligned} \Delta kWh_{fan} &= [365.25 \times 3 \times ((0.4 \times 15) + (0.4 \times 34) + (0.2 \times 67)) / 1000] - \\ & \quad [365.25 \times 3 \times ((0.4 \times 5) + (0.4 \times 14) + (0.2 \times 32)) / 1000] \\ &= 36.2 - 15.3 = 20.9 \text{ kWh} \\ \Delta kWh_{light} &= ((88.5 - 22.4) / 1000) \times 759 \times 1.06 \\ &= 53.2 \text{ kWh} \\ \Delta kWh &= 20.9 + 53.2 = 74.1 \text{ kWh} \end{aligned}$$

⁶⁸⁶ Through review of the ENERGY STAR Qualified Products List, accessed on May 5, 2022, the average ceiling fan LED light kit had 1.2 lamps, with an average wattage of 17.3 W. The comparable baseline is based on a scaled equivalent wattage from the 5.5.9 LED Fixtures measure.

SUMMER COINCIDENT PEAK DEMAND SAVINGS

$$\Delta kW = \Delta kW_{Fan} + \Delta kW_{light}$$

$$\Delta kW_{Fan} = ((WattsHigh_{base} - WattsHigh_{ES})/1000) * CF_{fan}$$

$$\Delta kW_{Light} = \text{see 5.5.9 LED Fixtures measure.}$$

Where:

$$CF_{fan} = \text{Summer Peak coincidence factor for ventilation savings} \\ = 30\%^{687}$$

$$CF_{light} = \text{Summer Peak coincidence factor for lighting savings} \\ = 7.1\%^{688}$$

For example, an ENERGY STAR ceiling fan with one 22.4W LED lamp as part of its light kit were purchased and installed to replace an existing ceiling fan that was no longer operational, the savings are:

$$\Delta kW_{fan} = ((67-32)/1000) * 0.3 \\ = 0.0105 \text{ kW}$$

$$\Delta kW_{light} = ((88.5 - 22.4)/1000) * 1.11 * 0.071 \\ = 0.0052 \text{ kW}$$

$$\Delta kW = 0.0105 + 0.0052 \\ = 0.016 \text{ kW}$$

FOSSIL FUEL SAVINGS

N/A

WATER IMPACT DESCRIPTIONS AND CALCULATION

N/A

DEEMED O&M COST ADJUSTMENT CALCULATION

See 5.5.9 LED Fixtures measure for bulb replacement costs.

MEASURE CODE: RS-HVC-CFAN-V04-230101

REVIEW DEADLINE: 1/1/2026

⁶⁸⁷ Assumes the CF is the same as a Room AC. Consistent with coincidence factors found in: RLW Report: Final Report Coincidence Factor Study Residential Room Air Conditioners, June 23, 2008.

⁶⁸⁸ Based on lighting logger study conducted as part of the PY5/6 ComEd Residential Lighting Program evaluation.

5.3.16 Advanced Thermostats

DESCRIPTION

This measure characterizes the household energy savings from the installation of a new thermostat(s) for reduced heating and cooling consumption through a configurable schedule of temperature setpoints (like a programmable thermostat) *and* automatic variations to that schedule to better match HVAC system runtimes to meet occupant comfort needs. These schedules may be defaults, established through user interaction, and be changed manually at the device or remotely through a web or mobile app. Automatic variations to that schedule could be driven by local sensors and software algorithms, and/or through connectivity to an internet software service. Data triggers to automatic schedule changes might include, for example: occupancy/activity detection, arrival & departure of conditioned spaces, optimization based on historical or population-specific trends, weather data and forecasts.⁶⁸⁹ This class of products and services are relatively new, diverse, and rapidly changing. Generally, the savings expected for this measure aren't yet established at the level of individual features, but rather at the system level and how it performs overall. Like programmable thermostats, it is not suitable to assume that heating and cooling savings follow a similar pattern of usage and savings opportunity, and so here too this measure treats these savings independently. Note that this is an active area of ongoing work to better map features to savings value, and establish standards of performance measurement based on field data so that a standard of efficiency can be developed.⁶⁹⁰ Since energy savings are applicable at the household level, savings should only be claimed for one thermostat of any type (i.e., one programmable thermostat or one advanced thermostat), and installation of multiple thermostats per home does not accrue additional savings.

Note that though these devices and service could potentially be used as part of a demand response program, the costs, delivery, impacts, and other aspects of DR-specific program delivery are not included in this characterization at this time, though they could be added in the future.

This measure was developed to be applicable to the following program types: TOS, NC, RF, DI.

If applied to other program types, the measure savings should be verified.

DEFINITION OF EFFICIENT EQUIPMENT

The criteria for this measure are established by replacement of a manual-only or programmable thermostat, with one that has the default enabled capability—or the capability to automatically—establish a schedule of temperature setpoints according to driving device inputs above and beyond basic time and temperature data of conventional programmable thermostats. As summarized in the description, this category of products and services is broad and rapidly advancing in regard to their capability, usability, and sophistication, but at a minimum must be capable of two-way communication⁶⁹¹ and exceed the typical performance of manual and conventional programmable thermostats through the automatic or default capabilities described above.

DEFINITION OF BASELINE EQUIPMENT

The baseline is either the actual type (manual or programmable) if it is known,⁶⁹² or an assumed mix of these two types based upon information available from evaluations or surveys that represent the population of program

⁶⁸⁹ For example, the capabilities of products and added services that use ultrasound, infrared, or geofencing sensor systems, automatically develop individual models of home's thermal properties through user interaction, and optimize system operation based on equipment type and performance traits based on weather forecasts demonstrate the type of automatic schedule change functionality that apply to this measure characterization.

⁶⁹⁰ The ENERGY STAR program released version 1.0 of its Connected Thermostats Specification in 2017. Details and active discussion can be found on ENERGY STAR website; 'Connected Thermostats Specifications v1.0'.

⁶⁹¹ This measure recognizes that field data may be available, through this 2-way communication capability, to better inform characterization of efficiency criteria and savings calculations. It is recommended that program implementations incorporate this data into their planning and operation activities to improve understanding of the measure to manage risks and enhance savings results.

⁶⁹² If the actual thermostat is programmable and it is found to be used in override mode or otherwise effectively being operated like a manual thermostat, then the baseline may be considered to be a manual thermostat.

participants. This mix may vary by program, but as a default, 51% programmed programmable and 49% manual or non-programmed programmable thermostats may be assumed.⁶⁹³

DEEMED LIFETIME OF EFFICIENT EQUIPMENT

The expected measure life for advanced thermostats is assumed to be 11 years.⁶⁹⁴

DEEMED MEASURE COST

For DI and other programs for which installation services are provided, the actual material, labor, and other costs should be used. For retail, Bring Your Own Thermostat (BYOT) programs,⁶⁹⁵ or other program types, actual costs are still preferable,⁶⁹⁶ but if unknown, then the average incremental cost for the new installation measure is assumed to be \$79.⁶⁹⁷

LOADSHAPE

- ΔkWh → Loadshape R10 - Residential Electric Heating and Cooling
- $\Delta kWh_{heating}$ → Loadshape R09 - Residential Electric Space Heat
- $\Delta kWh_{cooling}$ → Loadshape R08 - Residential Cooling

COINCIDENCE FACTOR

In the absence of conclusive results from empirical studies on peak savings, the TAC agreed to a temporary assumption of 50% of the cooling coincidence factor, acknowledging that while the savings from the advanced Thermostat will track with the cooling load, the impact during peak periods may be lower. This is an assumption that could use future evaluation to improve these estimates.

CF_{SSP} = Summer System Peak Coincidence Factor for Central A/C (during system peak hour)
= 34%⁶⁹⁸

CF_{PJM} = PJM Summer Peak Coincidence Factor for Central A/C (average during PJM peak period)
= 23.3%⁶⁹⁹

⁶⁹³ Based on Opinion Dynamics Corporation, “ComEd Residential Saturation/End Use, Market Penetration & Behavioral Study”, Appendix 3: Detailed Mail Survey Results, p34, April 2013.

⁶⁹⁴ Based on 2017 Residential Smart Thermostat Workpaper, prepared by SCE and Nest for SCE (Work Paper SCE17HC054, Revision #0). Estimate ability of smart systems to continue providing savings after disconnection and conduct statistical survival analysis which yields 9.2-13.8 year range.

⁶⁹⁵ In contrast to program designs that utilize program affiliated contractors or other trade ally partners that support customer participation through thermostat distribution, installation and other services, BYOT programs enroll customers *after* the time of purchase through online rebate and program integration sign-ups.

⁶⁹⁶ Including any one-time software integration or annual software maintenance, and or individual device energy feature fees.

⁶⁹⁷ Market prices vary considerably in this category, generally increasing with thermostat capability and sophistication. The core suite of functions required by this measure's eligibility criteria are available on units readily available in the market roughly in the range of \$100 and \$150, excluding the availability of time or market-limited wholesale or volume pricing. Analysis of the 2021 Pricing data from AIC’s Retail Products Program finds an average retail cost of \$129 for Advanced Thermostats. The assumed cost for the baseline equipment (blend of manual and programmable thermostats) is \$50 which leads to an incremental cost of \$79 for the measure. See AIC_RetailProducts_2021Costdata_AdvThermostats_051322.xlsx for analysis of the AIC program data. Note that any add-on energy service costs, which may include one-time setup and/or annual per device costs are not included in this assumption.

⁶⁹⁸ Assumes 50% of the cooling coincidence factor (based on metering of 24 homes with central AC during PY4 and PY5 in Ameren Illinois service territory).

⁶⁹⁹ Assumes 50% of the cooling coincidence factor (based on analysis of Itron eShape data for Missouri, calibrated to Illinois loads, supplied by Ameren. The average AC load over the PJM peak period (1-5pm, M-F, June through August) is divided by the maximum AC load during the year.)

Algorithm

CALCULATION OF SAVINGS

ELECTRIC ENERGY SAVINGS

$$\Delta kWh^{700} = \Delta kWh_{heating} + \Delta kWh_{cooling}$$

$$\Delta kWh_{heating} = \%ElectricHeat * Elec_Heating_Consumption * Heating_Reduction * HF * Eff_ISR_Heat + (\Delta Therms * F_e * 29.3)$$

$$\Delta kWh_{cool} = \%AC * ((FLH * Capacity * 1/SEER2)/1000) * Cooling_Reduction * Eff_ISR_Cool$$

Where:

%ElectricHeat = Percentage of heating savings assumed to be electric

Heating fuel	%ElectricHeat
Electric	100%
Natural Gas	0%
Unknown	3% ⁷⁰¹

Elec_Heating_Consumption

= Estimate of annual household heating consumption for electrically heated homes.⁷⁰² If location and heating type is unknown, assume 15,683 kWh.⁷⁰³

Climate Zone (City based upon)	Electric Resistance Elec_Heating_ Consumption (kWh)	Electric Heat Pump Elec_Heating_ Consumption (kWh)
1 (Rockford)	21,748	12,793
2 (Chicago)	20,777	12,222
3 (Springfield)	17,794	10,467
4 (Belleville)	13,726	8,074
5 (Marion)	13,970	8,218
Average	19,749	11,617

Heating_Reduction = Assumed percentage reduction in total household heating energy consumption due to advanced thermostat including accounting for Thermostat

⁷⁰⁰ Electrical savings are a function of both heating and cooling energy usage reductions. For heating this is a function of the percent of electric heat (heat pumps) and fan savings in the case of a natural gas furnace.

⁷⁰¹ Value used is based on known PY8 percent of electric heat provided by Navigant as part of the ongoing evaluation work source: "Slide 21: May 22, 2018, Second Addendum IL TRM Advanced Thermostat Cooling Savings Evaluation"

⁷⁰² Values in table are based on converting an average household heating load (834 therms) for Chicago based on 'Table E-1, Energy Efficiency/Demand Response Nicor Gas Plan Year 1: Research Report: Furnace Metering Study, Draft, Navigant, August 1 2013 to an electric heat load (divide by 0.03412) to electric resistance and ASHP heat load (resistance load reduced by 15% to account for distribution losses that occur in furnace heating but not in electric resistance while ASHP heat is assumed to suffer from similar distribution losses) and then to electric consumption assuming efficiencies of 100% for resistance and 200% for HP (see 'Household Heating Load Summary Calculations_08222018.xls'). Finally these values were adjusted to a statewide average using relative HDD assumptions to adjust for the evaluation results focus on northern region. Values for individual cities are then calculated by comparing average HDD to the individual city's HDD.

⁷⁰³ Assumption that 1/2 of electrically heated homes have electric resistance and 1/2 have Heat Pump, based on 2010 Residential Energy Consumption Survey for Illinois.

Optimization services⁷⁰⁴

Existing Thermostat Type	Heating Reduction ⁷⁰⁵
Manual	10.2%
Programmable	7.1%
Unknown (Blended)	8.5%

HF = Household factor, to adjust heating consumption for non-single-family households.

Household Type	HF
Single-Family	100%
Mobile home	83% ⁷⁰⁶
Multifamily	65% ⁷⁰⁷
Actual	Custom ⁷⁰⁸
Unknown	96.5% ⁷⁰⁹

Use Multifamily if: Building meets utility’s definition for multifamily and system serves single unit. For residential sized systems serving 2 or more units, assume single family hours. For central systems use Volume 2 Commercial and Industrial Measures.

Eff_ISR_Heat = Effective In-Service Rate for heating, the percentage of thermostats installed and configured effectively for 2-way communication. Note that retrospective adjustments should be made during evaluation verification activities through the use of a realization rate if the program design does not ensure that each advanced thermostat is actually installed and/or if the evaluation determines that the advanced thermostat is not actually installed in the Program Administrator’s service territory.

Program Delivery	Eff_ISR_Heat
Direct Install	100%

⁷⁰⁴ This estimate is based on a consumption data analysis with matching to non-participants and is therefore net with respect to participant spillover and between net and gross with respect to free ridership. Like all consumption data analyses, it is gross with respect to non-participant spillover. For more detail, see Table 5-3 in Volume 4 of the IL-TRM. Consistent with Section 7.2 of the Illinois EE Policy Manual, applicable net-to-gross adjustments to these factors will be determined as part of the annual SAG net-to-gross process.

⁷⁰⁵ These values represent adjusted baseline savings values (8.8% for manual, and 5.6% for programmable thermostats) as presented in Navigant’s PowerPoint on Impact Analysis from Preliminary Gas savings findings (slide 28 of ‘IL SAG Smart Thermostat Preliminary Gas Impact Findings 2015-12-08 to IL SAG.ppt’), and incorporate any inherent in service rate impact. These values are adjusted upwards in v9 to account for inclusion of Thermostat Optimization savings in an estimated 40% of future participants (based on reported share of Nest and ecobee participants and 2020 rates of Thermostat Optimization and including an assumed 90% ISR consistent with the Guidehouse cooling savings study). The basis for the Thermostat Optimization savings is Navigant “ComEd CY2018 Seasonal Savings Heating Season Impact Evaluation Report”, March 2019.

These values are used as the basis for the weighted average savings value when the type of existing thermostat is not known. Using weightings updated from PY8 data, based upon baseline type, and allocating programmability into manual and programmable based upon programmed status yields a weighted new blend of 43% manual (or non-programmed programmable) and 57% programmed. Further evaluation and regular review of this key assumption is encouraged.

⁷⁰⁶ Since mobile homes are similar to Multifamily homes with respect to conditioned floor area but to single-family homes with respect to exposure (i.e., all four wall orientations are adjacent to the outside), this factor is estimated as an average of the single family and multifamily household factors.

⁷⁰⁷ Multifamily household heating consumption relative to single-family households is affected by overall household square footage and exposure to the exterior. This 65% reduction factor is applied to MF homes, based on professional judgment that average household size, and heat loads of MF households are smaller than single-family homes

⁷⁰⁸ Program-specific household factors may be utilized on the basis of sufficiently validated program evaluations.

⁷⁰⁹ When Household type is unknown, a value of 96.5% may be used as a weighted average of 90% SF and 10% MF (96.5% = 100%*90% + 65%*10%) based on a Navigant evaluation of PY8 participants in ComEd’s advanced thermostat program.

Program Delivery	Eff_ISR_Heat
Self-install with Thermostat provided free of charge	54% ⁷¹⁰
Other programs where not evaluated	100% ⁷¹¹

Δ Therms = Therm savings if Natural Gas heating system
 = See calculation in Fossil Fuel section below

F_e = Furnace Fan energy consumption as a percentage of annual fuel consumption
 = 3.14%⁷¹²

29.3 = kWh per therm

%AC = Fraction of customers with thermostat-controlled air-conditioning

Thermostat control of air conditioning?	%AC ⁷¹³
Yes	100%
No	0%
Unknown (AC-targeted program)	99%
Unknown (general program)	82.5%

FLH = Estimate of annual household full load cooling hours for air conditioning equipment based on location and home type. If climate zone is unknown, assume the weighted average for the relevant home type. If both climate zone and home type are unknown, assume 723 hours.⁷¹⁴

Climate zone (city based upon)	FLH (single family) ⁷¹⁵	FLH (general multifamily) ⁷¹⁶	FLH_cooling (weatherized multifamily) ⁷¹⁷
1 (Rockford)	547	499	320
2 (Chicago)	709	629	403

⁷¹⁰ The 2022 and 2023 Opinion Dynamics evaluations showed that many single family participants who signed up to receive a self-install advanced thermostat did not install it. The value represents an average of the two evaluation years.

⁷¹¹ As a function of the method for determining savings impact of these devices, in-service rate effects are already incorporated into the savings value for heating_reduction above.

⁷¹² F_e is not one of the AHRI certified ratings provided for residential furnaces, but can be reasonably estimated from a calculation based on the certified values for fuel energy (Ef in MMBTU/yr) and Eae (kWh/yr). An average of a 300 record sample (non-random) out of 1495 was 3.14%. This is, appropriately, ~50% greater than the ENERGY STARversion 3 criteria for 2% F_e . See "Programmable Thermostats Furnace Fan Analysis.xlsx" for reference.

⁷¹³ 99% of ComEd PY8 program participants (AC targeted programs) have Central AC per communication with Navigant's ongoing 2017/2018 cooling savings evaluation. Non-targeted programs are still expected to have participation with %AC above general population rates. 82.5% is an average of the 99% program participation rate, and the 66% of homes in Illinois having central cooling ("Table HC7.9 Air Conditioning in Homes in Midwest Region, Divisions, and States, 2009 from Energy Information Administration", 2009 Residential Energy Consumption Survey ;

⁷¹⁴ When both climate zone and home type are unknown, a value of 723 hours may be used as a weighted average of 90% SF and 10% MF (723 = 731*90% + 655*10%) based on a Navigant evaluation of PY8 participants in ComEd's advanced thermostat program.

⁷¹⁵ Full load hours for Chicago, Moline and Rockford are provided in "Final Evaluation Report: Central Air Conditioning Efficiency Services (CACES), 2010, Navigant Consulting", p.33. An average FLH/Cooling Degree Day (from NCDC) ratio was calculated for these locations and applied to the CDD of the other locations in order to estimate FLH. There is a county mapping table in Volume 1, Section 3.7 providing the appropriate city to use for each county of Illinois.

⁷¹⁶ Ibid.

⁷¹⁷ All-Electric Homes PY6 Metering Results: Multifamily HVAC Systems, Cadmus, October 2015

Climate zone (city based upon)	FLH (single family) ⁷¹⁵	FLH (general multifamily) ⁷¹⁶	FLH_cooling (weatherized multifamily) ⁷¹⁷
3 (Springfield)	779	707	453
4 (Belleville)	1082	982	630
5 (Marion/Murphysboro)	956	868	557
Weighted Average ⁷¹⁸			
ComEd	676	603	386
Ameren	875	791	507
Statewide	731	655	420

Use Multifamily if: Building meets utility’s definition for multifamily and system serves single unit. For residential sized systems serving 2 or more units, assume single family hours. For central systems use Volume 2 Commercial and Industrial Measures.

- Capacity** = Size of AC unit. (Note: One refrigeration ton is equal to 12,000 Btu/hr)
- = Use actual when program delivery allows size of AC unit to be known. If unknown assume 33,600 Btu/hr for single family homes, 28,000 Btu/hr for multifamily or 24,000 Btu/hr for mobile homes.⁷¹⁹ If building type is unknown, assume 33,040 Btu/hr.⁷²⁰
- SEER2** = the cooling equipment’s Seasonal Energy Efficiency Ratio rating (kBtu/kWh)
- = Use actual SEER2 rating where it is possible to measure or reasonably estimate. If using rated efficiencies, derate efficiency value by 1% per year (maximum of 30 years) to account for degradation over time,⁷²¹. If unknown, use the following assumption (do not derate further by age):

Cooling System	SEER2 ⁷²²
Air Source Heat Pump	11.4
Central AC	

- 1/1000** = kBtu per Btu
- Cooling_Reduction** = Assumed average percentage reduction in total household cooling energy consumption due to installation of advanced thermostat including accounting for Thermostat Optimization:⁷²³

⁷¹⁸ Weighted based on number of occupied residential housing units in each zone. Weighting for Ameren is based on electric accounts in each of the cooling zones. Weighting for ComEd and Statewide average is based on number of occupied residential housing units in each zone. ComEd is weighted average of Zones 1-2. Alternative program-weighted assumptions can be used if appropriate.

⁷¹⁹ Single family cooling capacity based on Final Evaluation Report: Central Air Conditioning Efficiency Services (CACES), October 19, 2010, ComEd, Navigant Consulting. Multifamily capacity based on weighted average of PY9 Ameren and ComEd MF cooling capacities. Mobile home capacity based on ENERGY STAR’s Manufactured Home Cooling Equipment Sizing Guidelines which vary by climate zone and home size. The average size of a mobile home in the East North Central region (1,120 square feet) from the 2015 RECS data is used to calculate appropriate size.

⁷²⁰ Unknown is based on statewide weighted average of 90% single family and 10% multifamily, based on a Navigant evaluation of PY8 participants in ComEd’s advanced thermostat program.

⁷²¹ Justification for degradation factors can be found on page 14 of ‘AIC HVAC Metering Study Memo FINAL 2_28_2018’. Estimate efficiency as (Rated Efficiency * (1-0.01)^Equipment Age).

⁷²² Estimate based upon Navigant, 2018 “EIA – Technology Forecast Updates – Residential and Commercial Building Technologies – Reference Case”, converted to SEER2.

⁷²³ Note that “Cooling_Reduction” percentage is the savings expected from reduced cooling use, and is not the same as % cooling savings that are based on total kWh saved (including fan and heating kWh savings) as a percent of total kWh used for cooling.

$$= 8.4\%^{724}$$

Eff_ISR_Cool = Effective In-Service Rate for cooling, the percentage of thermostats installed and configured effectively for 2-way communication. Note that retrospective adjustments should be made during evaluation verification activities through the use of a realization rate if the program design does not ensure that each advanced thermostat is actually installed and/or if the evaluation determines that the advanced thermostat is not actually installed in the Program Administrator’s service territory.

Program Delivery	Eff_ISR_Cool
Direct Install	100%
Self-install with Thermostat provided free of charge	54% ⁷²⁵
Other programs where not evaluated	90% ⁷²⁶

For example, an advanced thermostat replacing a programmable thermostat direct-installed in an electric heat pump heated, single-family home in Springfield with advanced thermostat-controlled air conditioning of a system of unknown size and seasonal efficiency rating:

$$\begin{aligned} \Delta kWh &= \Delta kWh_{\text{heating}} + \Delta kWh_{\text{cooling}} \\ &= 1 * 10,464 * 7.1\% * 100\% * 100\% + (0 * 0.0314 * 29.3) + 100\% * ((779 * 33,600 * (1/11.4))/1000) * 8.4\% * 100\% \\ &= 743kWh + 193 kWh \\ &= 936 kWh \end{aligned}$$

SUMMER COINCIDENT PEAK DEMAND SAVINGS

$$\Delta kW = \%AC * (\text{Cooling_DemandReduction} * \text{Btu/hr} * (1/\text{EER2})/1000) * \text{EFF_ISR_Cool} * \text{CF}$$

⁷²⁴ The Cooling_Reduction assumption is based on a TAC agreement to weight the consumption data analysis result (econometric) and the adjusted ENERGY STAR method for estimating runtime savings for advanced thermostats with stakeholder assumptions about baseline behavior (ENERGY STAR), provided by Guidehouse in 2020. The econometric result (7.8%) is weighted at 90%, and the ENERGY STAR result (10-14% range taken as reasonable by stakeholders, however 14% is used to account for increased Thermostat Optimization) weighted at 10%.

This econometric value is based upon the non-weather normalized savings percentage, adjusted for selection bias, %AC and ISR, with additional adjustment to account for the anticipated growth in Thermostat Optimization savings, from 12% of participants in the study to 45% of future participants (based on reported share of Nest and ecobee participants and 2020 rates of Thermostat Optimization). The basis for the Thermostat Optimization savings is Navigant’s “ComEd CY2018 Seasonal Savings Cooling Season Impact Evaluation Report”, March 2019. The estimate of cooling reduction factor includes an adjustment for apparent selection bias, per stakeholder request as part of a 2020 study by Guidehouse involving a consumption analysis of ComEd advanced thermostat rebate recipients. Guidehouse acknowledges that this adjustment is a coarse method of addressing potential bias, but believes that this adjustment may not be accurate or applicable for future studies of this type.

The adjusted ENERGY STAR analysis is gross with respect to all components of net-to-gross (free ridership, and participant and non-participant spillover). The econometric analysis uses matching to future participants and is therefore gross with respect to free ridership. Like all consumption data analyses, it is net with respect to participant spillover and gross with respect to non-participant spillover. For more detail, see Table 5-3 in Volume 4 of the IL-TRM. Consistent with Section 7.2 of the Illinois EE Policy Manual, applicable net-to-gross adjustments to these factors will be determined as part of the annual SAG net-to-gross process.

⁷²⁵ The 2022 and 2023 Opinion Dynamics evaluations showed that many single family participants who signed up to receive a self-install advanced thermostat did not install it. The value represents an average of the two evaluation years.

⁷²⁶ The 2020 Guidehouse evaluation indicated that 6.75% of participants installed the advanced thermostat out of state. An additional reduction is applied to account for purchases that are never installed. Based on the available data this is estimated as an additional 3.75%.

Where:

Cooling_DemandReduction = Assumed average percentage reduction in total household cooling demand due to installation of advanced thermostat including accounting for Thermostat Optimization services
 = 16.4%⁷²⁷

EER2 = Energy Efficiency Ratio of existing cooling system (kBtu/hr / kW)
 = Use actual EER2 rating where it is possible to measure or reasonably estimate. If EER2 unknown but SEER2 available convert using the equation:

$$EER2 = (-0.02 * SEER2_exist^2) + (1.12 * SEER2_exist)^{728}$$

If SEER2 or EER2 rating unavailable, use:

Cooling System	EER2 ⁷²⁹
Air Source Heat Pump	10.0
Central AC	

CF_{SSP} = Summer System Peak Coincidence Factor for Central A/C (during system peak hour)
 = 34%⁷³⁰

CF_{PJM} = PJM Summer Peak Coincidence Factor for Central A/C (average during PJM peak period)
 = 23.3%⁷³¹

For example, an advanced thermostat replacing a programmable thermostat directly installed in an electric resistance heated, single-family home in Springfield with advanced thermostat-controlled air conditioning of a system of unknown size and seasonal efficiency rating:

$$\Delta kW_{SSP} = 100\% * (16.4\% * 33,600 * (1/10.0)/1000) * 100\% * 34\% = 0.1874 \text{ kW}$$

$$\Delta kW_{PJM} = 100\% * (16.4\% * 33,600 * (1/10.0)/1000) * 100\% * 23.3\% = 0.1284 \text{ kW}$$

FOSSIL FUEL SAVINGS

$$\Delta Therms = \%FossilHeat * Gas_Heating_Consumption * Heating_Reduction * HF * Eff_ISR_Heat$$

⁷²⁷ The current Cooling_DemandReduction assumption is based on results presented on August 4th, 2020 from a Guidehouse econometric analysis and further refinements discussed throughout August.

The final value is based upon the non-weather normalized savings percentage, adjusted for selection bias, %AC and ISR, provided by the Guidehouse econometric results, and includes an additional adjustment to account for the anticipated growth in Thermostat Optimization savings, The estimate of cooling reduction factor includes an adjustment for apparent selection bias, per stakeholder request as part of a 2020 study by Guidehouse involving a consumption analysis of ComEd advanced thermostat rebate recipients. Guidehouse acknowledges that this adjustment is a coarse method of addressing potential bias, but believes that this adjustment may not be accurate or applicable for future studies of this type.

⁷²⁸ From Wassmer, M. (2003). A Component-Based Model for Residential Air Conditioner and Heat Pump Energy Calculations. Masters Thesis, University of Colorado at Boulder.

⁷²⁹ Based on converting SEER2 assumption to EER2.

⁷³⁰ Assumes 50% of the cooling coincidence factor (based on metering of 24 homes with central AC during PY4 and PY5 in Ameren Illinois service territory.)

⁷³¹ Assumes 50% of the cooling coincidence factor (based on analysis of Itron eShape data for Missouri, calibrated to Illinois loads, supplied by Ameren. The average AC load over the PJM peak period (1-5pm, M-F, June through August) is divided by the maximum AC load during the year.)

Where:

%FossilHeat = Percentage of heating savings assumed to be Natural Gas

Heating fuel	%FossilHeat
Electric	0%
Natural Gas	100%
Unknown	97% ⁷³²

Gas_Heating_Consumption

= Estimate of annual household heating consumption for gas heated single-family homes. If location is unknown, assume the average below.⁷³³

Climate Zone (City based upon)	Gas_Heating_Consumption (therms)
1 (Rockford)	1,052
2 (Chicago)	1,005
3 (Springfield)	861
4 (Belleville)	664
5 (Marion)	676
Average	955

Other variables as provided above.

For example, an advanced thermostat replacing a programmable thermostat directly-installed in a gas heated single-family home in Chicago:

$$\begin{aligned} \Delta\text{Therms} &= 1.0 * 1005 * 7.1\% * 100\% * 100\% \\ &= 71.4 \text{ therms} \end{aligned}$$

WATER IMPACT DESCRIPTIONS AND CALCULATION

N/A

DEEMED O&M COST ADJUSTMENT CALCULATION

N/A

MEASURE CODE: RS-HVC-ADTH-V10-250101

REVIEW DEADLINE: 1/1/2028

⁷³² Value used is based on known PY8 percent of electric heat provided by Navigant as part of the ongoing evaluation work source: "Slide 21: May 22, 2018, Second Addendum IL TRM Advanced Thermostat Cooling Savings Evaluation"

⁷³³ Values are based on adjusting the average household heating consumption (849 therms) for Chicago based on 'Table 3-4, Program Sample Analysis, Nicor R29 Res Rebate Evaluation Report 092611_REV FINAL to Nicor', calculating inferred heating load by dividing by average efficiency of new in program units in the study (94.4%) and then applying standard assumption of existing unit efficiency of 83% (estimate based on 24% of furnaces purchased in Illinois were condensing in 2000 (based on data from GAMA, provided to Department of Energy), assuming typical efficiencies: (0.24*0.92) + (0.76*0.8) = 0.83). This Chicago value was then adjusted to a statewide average using relative HDD assumptions to adjust for the evaluation results focus on northern region. Values for individual cities are then calculated by comparing average HDD to the individual city's HDD.

5.3.17 Gas High Efficiency Combination Boiler

DESCRIPTION

Space heating boilers are pressure vessels that transfer heat to water for use in space heating. Boilers either heat water using a heat exchanger that works like an instantaneous water heater or by adding/connecting a separate tank with an internal heat exchanger to the boiler. A combination boiler contains a separate heat exchanger that heats water for domestic hot water use. Qualifying combination boilers must be whole-house units used for both space heating and domestic water heating with one appliance and energy source. Only participants who have a natural gas account with a participating natural gas utility are eligible for this rebate.

Optionally, when applying an early replacement rate for two-in-one boiler upgrades, the following weighted average is provided for use in downstream programs when the actual baseline early replacement rates are unknown.⁷³⁴

Deemed Early Replacement Rates for Boilers

	Deemed Early Replacement Rate
Early Replacement Rate for Boiler participants	7%

This measure was developed to be applicable to the following program types: TOS or ER. If applied to other program types, the measure savings should be verified.

DEFINITION OF EFFICIENT EQUIPMENT

The efficient condition is a condensing combination boiler unit with boiler AFUE of 90% or greater. The combination boiler must have a sealed combustion unit and be capable of modulating the firing rate and must be accompanied by a programmed outdoor reset control.⁷³⁵ Measures that do not qualify for this incentive include boilers with a storage tank and redundant or backup boilers.

DEFINITION OF BASELINE EQUIPMENT

The baseline condition is a boiler with the federal minimum of 84% AFUE and a residential, natural gas-fueled storage water heater meeting minimum Federal efficiency standards as described below:

Equipment Type	Sub Category	Draw Pattern	Federal Standard – Uniform Energy Factor ⁷³⁶
Residential Gas Storage Water Heaters ≤75,000 Btu/h	≤55 gallon tanks	Very small	UEF = 0.3456 – (0.0020 * Rated Storage Volume in Gallons)
		Low	UEF = 0.5982 – (0.0019 * Rated Storage Volume in Gallons)
		Medium	UEF = 0.6483 – (0.0017 * Rated Storage Volume in Gallons)
		High	UEF = 0.6920 – (0.0013 * Rated Storage Volume in Gallons)
	>55 gallon and ≤100 gallon tanks	Very small	UEF = 0.6470 – (0.0006 * Rated Storage Volume in Gallons)
		Low	UEF = 0.7689 – (0.0005 * Rated Storage Volume in Gallons)
		Medium	UEF = 0.7897 – (0.0004 * Rated Storage Volume in Gallons)
		High	UEF = 0.8072 – (0.0003 * Rated Storage Volume in Gallons)

⁷³⁴ Based upon research from “Home Energy Efficiency Rebate Program GPY2 Evaluation Report” which outlines early replacement rates for both primary and secondary central air cooling (CAC) and residential furnaces. This is used as a reasonable proxy for boiler installations since boiler specific data is not available. Report presented to Nicor Gas Company February 27, 2014.

⁷³⁵ In a 2015 study, the Cadmus Group team conducted an analysis of optimal outdoor reset curves and discovered that “a boiler in Massachusetts with well-programmed outdoor reset controls could see an operating efficiency improvement of up to 3 to 4 percentage points from the average efficiency of 88.4% observed”.

⁷³⁶ DOE Standard 10 CFR 430, Residential-Duty and Commercial Federal Standard are from DOE Standard 10 CFR 431. Minimum Federal standard as of 4/16/2015, confirmed no changes as of 6/20/2021; https://www.ecfr.gov/cgi-bin/text-idx?SID=80dfa785ea350ebee184bb0ae03e7f0&mc=true&node=se10.3.430_132&rpn=div8

Draw patterns are based on first hour rating (gallons) for storage tanks as shown below:⁷³⁷

Storage Water Heater Draw Pattern	
Draw Pattern	First Hour Rating (gallons)
Very Small	≥ 0 and < 18
Low	≥ 18 and < 51
Medium	≥ 51 and < 75
High	≥ 75

If using a deemed approach, for storage water heaters with a storage capacity equal to or less than 55 gallons, the Federal energy factor requirement is calculated as $0.6483 - (0.0017 * \text{storage capacity in gallons})$ assuming a Medium draw and 50 gallon tank (resulting in 0.5633 EF).

DEEMED LIFETIME OF EFFICIENT EQUIPMENT

The expected measure life is assumed to be 21.5 years.⁷³⁸

DEEMED MEASURE COST

The incremental measure cost is assumed to be \$1,663 for a 90-94% AFUE unit and \$2,421 for a unit greater than or equal to 95% AFUE.⁷³⁹

LOADSHAPE

N/A

COINCIDENCE FACTOR

N/A

⁷³⁷ Definitions provided in 10 CFR 430, Subpart B, Appendix E, Section 5.4.1

⁷³⁸ US Department of Energy, Technical Support Document: Energy Efficiency Program for Consumer Products and Commercial and Industrial Equipment: Residential Furnaces.” February 10, 2015. Table 8.2.1, p. 8-23. The document’s definition of furnaces includes hot water boilers with firing rates of less than 300,000 Btu/h.

⁷³⁹ Northeast Energy Efficiency Partnerships. Incremental Cost Study Report. September 23, 2011. Incremental measure cost of \$2,791.00 for a combination boiler and \$2,461.00 for a high efficiency boiler sized at 110 Mbh. The percentage increase is applied to the current boiler incremental cost assumptions.

Algorithm

CALCULATION OF ENERGY SAVINGS

ELECTRIC ENERGY SAVINGS

N/A

SUMMER COINCIDENT PEAK DEMAND SAVINGS

N/A

FOSSIL FUEL SAVINGS

$$\Delta\text{Therms} = \Delta\text{Therm}_{\text{Boiler}} + \Delta\text{Therm}_{\text{WH}}$$

$$\Delta\text{Therms}_{\text{Boiler}} = (\text{EFLH} * \text{CAP}_{\text{Input}} * (\text{AFUE}_{\text{Eff}} / \text{AFUE}_{\text{Base}} - 1)) / 100,000$$

$$\Delta\text{Therms}_{\text{WH}} = (1/\text{UEF}_{\text{Base}} - 1/\text{UEF}_{\text{Eff}}) * (\text{GPD} * \text{Household} * 365.25 * \gamma_{\text{Water}} * (\text{T}_{\text{OUT}} - \text{T}_{\text{IN}}) * 1.0) / 100,000$$

Where:

$\text{CAP}_{\text{Input}}$ = Gas Furnace input capacity (Btuh)

= Actual

EFLH = Equivalent Full Load Hours for gas heating

Climate Zone (City based upon)	EFLH ⁷⁴⁰
1 (Rockford)	1022
2 (Chicago)	976
3 (Springfield)	836
4 (Belleville)	645
5 (Marion)	656
Weighted Average ⁷⁴¹	
ComEd	978
Ameren	800
Statewide	928

$\text{AFUE}_{\text{Base}}$ = Baseline boiler annual fuel utilization efficiency rating

= 84%

AFUE_{Eff} = Efficient boiler annual fuel utilization efficiency rating

= Actual. If unknown, use defaults dependent on tier as listed below.⁷⁴²

Measure Type	AFUE_{Eff}
$\text{AFUE} \geq 90\%$	92.5%
$\text{AFUE} \geq 95\%$	95%

⁷⁴⁰ Full load hours for Chicago, are based on findings in ‘Energy Efficiency / Demand Response Nicor Gas Plan Year 1 (6/1/2011-5/31/2012) Research Report: Furnace Metering Study (August 1, 2013), prepared by Navigant Consulting, Inc. Values for other cities are then calculated by comparing relative HDD at base 60F.

⁷⁴¹ Weighting for Ameren is based on gas accounts in each of the heating zones. Weighting for ComEd and Statewide average is based on number of occupied residential housing units in each zone. ComEd is weighted average of Zones 1-2. Alternative program-weighted assumptions can be used if appropriate.

⁷⁴² Default values per tier selected based upon the average AFUE value for the tier range except for the top tier where the minimum is used due to proximity to the maximum possible.

- UEF_{Base} = Uniform Energy Factor rating of standard storage water heater according to federal standards provided in table in baseline section. For a deemed approach:
 = For gas storage water heaters ≤ 55 gallons: $0.6483 - (0.0017 * \text{storage capacity in gallons})$
 = For gas storage water heaters > 55 gallons: $0.8072 - (0.0003 \times \text{storage capacity in gallons})$
 = If tank size is unknown, assume 0.563 for a gas storage water heater with a 50-gallon storage capacity
- UEF_{Eff} = Uniform Energy Factor rating for efficient combination boiler. This is assumed consistent with a condensing instantaneous gas-fired water heater.
 = 0.954⁷⁴³
- GPD = Gallons per day of hot water use per person
 = 45.5 gallons hot water per day per household / 2.59 people per household⁷⁴⁴
 = 17.6
- Household = Average number of people per household

Household Unit Type	Household ⁷⁴⁵		
	IQ Participants	Non-IQ Participants	All Participants
Single-Family - Deemed	2.76	2.62	2.67
Multifamily - Deemed	2.3	2.09	2.18
Household type unknown			2.52 ⁷⁴⁶
Custom	Actual Occupancy or Number of Bedrooms ⁷⁴⁷		

Use Multifamily if: Building meets utility’s definition for multifamily

- 365.25 = Days per year, on average
- γ_{Water} = Specific weight of water
 = 8.33 pounds per gallon
- T_{OUT} = Tank temperature
 = 125°F
- T_{IN} = Incoming water temperature from well or municipal system
 = 50.7°F⁷⁴⁸
- 1.0 = Heat capacity of water (1 Btu/lb*°F)

⁷⁴³ Average Uniform Energy Factor from CAC appliance database accessed 4/22/2022 for instantaneous gas-fired water heaters. The water heater portion of a gas high efficiency combination boiler is essentially a tankless water heater.

⁷⁴⁴ Deoreo, B., and P. Mayer. Residential End Uses of Water Study Update. Forthcoming. ©2015 Water Research Foundation. Reprinted With Permission.

⁷⁴⁵ Assumptions are taken from the draft unadjusted 2024 Baseline Study evaluation data provided in 07/2024 by GDS Associates.

⁷⁴⁶ Unknown is based on statewide weighted average of 69% single family and 31% multifamily, based on IL data from 2009 RECS Table HC2.9 Structural and Geographic Characteristics of Homes in Midwest Region, Divisions and States, 2009.

⁷⁴⁷ Bedrooms are suitable proxies for household occupancy, and may be preferable to actual occupancy due to turnover rates in residency and non-adult population impacts.

⁷⁴⁸ Table 4 in Chen, et. al., “Calculating Average Hot Water Mixes of Residential Plumbing Fixtures”, June 2020, reports a value of 50.7°F for inlet water temperature for U.S. Census Division 3.

For example, a Rockford single-family IQ home installing an 80,000 Btuh condensing combination boiler unit with boiler AFUE of 95%:

$$\begin{aligned}\Delta\text{Therms}_{\text{Boiler}} &= (1,022 * 80,000 * (0.95/0.84 - 1))/100,000 \\ \Delta\text{Therms}_{\text{SWH}} &= (1/0.5863 - 1/0.954) * (17.6 * 2.76 * 365.25 * 8.33 * (125-50.7) * 1.0)/100,000 \\ \Delta\text{Therms} &= 107.1 + 72.2 \\ &= 179.3 \text{ Therms}\end{aligned}$$

WATER AND OTHER NON-ENERGY IMPACT DESCRIPTIONS AND CALCULATION

N/A

DEEMED O&M COST ADJUSTMENT CALCULATION

N/A

MEASURE CODE: RS-HVC-COMB-V05-250101

REVIEW DEADLINE: 1/1/2026

5.3.18 Furnace Filter Alarm – Provisional Measure

Measure has been removed in v9.0 due to evaluation results showing filter alarms being ineffectual at indicating a dirty filter.

5.3.19 Thermostatic Radiator Valves – Provisional Measure

DESCRIPTION

Thermostatic Radiator Valves (TRVs) are installed on hydronic or steam radiators to provide temperature control within a room or space. The TRV is a self-regulating valve requiring no auxiliary power, allowing the user to set the temperature to their preferred set point. On hydronic and two-pipe steam systems, as the room temperature rises the valve head expands, blocking the flow of hot water or steam into the radiator. On a one-pipe steam system the TRVs are installed on the air vent and limit the amount of air escaping the radiator, which in turn limits the amount of steam filling the radiator.

The current measure is limited to retrofit application in Multifamily buildings. TRVs are particularly effective in large multifamily buildings where some rooms tend to be overheated resulting in tenants leaving windows open even in winter.

From limited evaluation results, savings appear to be dependent on being part of a whole system commissioning and balancing project.

This measure was developed to be applicable to the following program types: RF. If applied to other program types, the measure savings should be verified.

DEFINITION OF EFFICIENT EQUIPMENT

To qualify for this measure the TRV is installed on an existing hydronic or steam heated radiator in a multifamily building.

DEFINITION OF BASELINE EQUIPMENT

The baseline is an existing hydronic or steam heated radiator without a TRV installed.

DEEMED LIFETIME OF EFFICIENT EQUIPMENT

The expected measure life of a TRV is estimated as 15 years.⁷⁴⁹

DEEMED MEASURE COST

The actual cost per TRV should be used. If unknown assume a measure cost of \$200 for steam systems and \$250 for hot water per TRV.⁷⁵⁰ If the heating system is required to be drained, the full cost should be used and split between all TRVs installed.

LOADSHAPE

N/A

COINCIDENCE FACTOR

N/A

⁷⁴⁹ Estimate based on assumption used in Department of Energy, Dentz et al, “Thermostatic Radiator Valve Evaluation”, January 2015.

⁷⁵⁰ Department of Energy, Dentz et al, “Thermostatic Radiator Valve Evaluation”, January 2015, Table 2, Page 7.

Algorithm

CALCULATION OF SAVINGS

ELECTRIC ENERGY SAVINGS

N/A

SUMMER COINCIDENT PEAK DEMAND SAVINGS

N/A

FOSSIL FUEL SAVINGS

$$\Delta\text{Therms} = \text{Gas_Heating_Load} / (\mu\text{Boiler} * \#\text{Radiators}) * \% \text{TRVSavings}$$

Where:

ΔTherms = Therm savings per TRV installed

Gas_Heating_Load = Estimated Gas heating Load per multi family unit.⁷⁵¹

Climate Zone (City based upon)	Gas_Heating_Load per Multi family unit (therms)
1 (Rockford)	567
2 (Chicago)	542
3 (Springfield)	464
4 (Belleville)	358
5 (Marion)	365
Average	515

μBoiler = AFUE Efficiency of the boiler system
= Actual. If unknown assume 75%

$\#\text{Radiators}$ = Number of radiators in the multifamily unit.
= Actual. If unknown estimated as five.

$\% \text{TRVSavings}$ = Estimate of heating consumption savings from installing a TRV⁷⁵²
= 15% when part of a system balancing project to address overheated spaces
= 5% if installed without system balancing

⁷⁵¹ This assumption is based on the Single Family Gas Heating Consumption for boiler values provided in 5.3.14 Boiler Reset Controls (based on Table 3-4, Program Sample Analysis, *Nicor R29 Res Rebate Evaluation Report 092611_REV FINAL to Nicor*) multiplied by a 65% adjustment factor, which is used to account for the expected lower multifamily heating consumption relative to single-family households due to overall household square footage and exposure to the exterior.

⁷⁵² Based on literature review of a limited number of studies available including:

Department of Energy, Dentz et al, “Thermostatic Radiator Valve Evaluation”, January 2015.

NYSERDA “Thermostatic Radiator Valve Demonstration Project”, 1995.

Lublin University of Technology Cholewa et al “Actual energy savings from the use of thermostatic radiator valves in residential buildings – Long term field evaluation”, July 2017.

For example, a TRV is installed on three of five radiators in a multifamily unit with a central 75% AFUE hydronic boiler, as part of a system balancing project in Chicago.

$$\begin{aligned}\Delta\text{Therms per TRV} &= \text{Gas_Heating_Load} / (\mu\text{Boiler} * \#\text{Radiators}) * \% \text{TRVSavings} \\ &= 542 / (0.75 * 5) * 0.15 \\ &= 21.7 \text{ Therms}\end{aligned}$$

Total of $19.6 * 3 = 65.1$ Therms for the multi family unit

WATER IMPACT DESCRIPTIONS AND CALCULATION

N/A

DEEMED O&M COST ADJUSTMENT CALCULATION

N/A

MEASURE CODE: RS-HVC-TRVS-V01-210101

REVIEW DEADLINE: 1/1/2023

5.3.20 Residential Energy Recovery Ventilator (ERV)

DESCRIPTION

Unconditioned outdoor air is typically warmer or cooler than desired by the occupants and is often also more humid than desired. A Residential ERV system provides necessary outdoor air ventilation while preheating or precooling the outdoor air, and, in some Residential ERV systems, pre-dehumidifying the outdoor air as well. This saves energy required for heating, cooling, and dehumidifying the residence.

An ERV generally comprises two fans (Exhaust and Outdoor Intake) that pass the two streams of air through a heat exchanger, which may be a fixed plate heat exchanger or a rotary heat recovery wheel. Sensible heat from the warmer air stream is transferred to the cooler air stream, thereby reducing the amount of heating energy or cooling energy needed to condition the outdoor air to desired indoor air temperature and humidity levels. The heat exchanger surfaces, in some ERV models, may be coated with a hygroscopic material that absorbs/releases or transfers latent moisture from one air stream to the other. This increases the overall energy transfer efficiency during humid summer months by partially dehumidifying moist outdoor air using the relatively drier indoor exhaust air. In the winter, this same effect serves to humidify the outdoor air, making the space more comfortable, but not saving significant energy.

The current measure serves all residential single family and Group R2, R3 and R4 dwellings of 3 stories or less, both existing and new, where ERV is not required to comply with energy code.

This measure was developed to be applicable to electric cooling systems and electric or natural gas heating systems in the following program types: RF, NC, TOS. If applied to other program types, the measure savings should be verified.

DEFINITION OF EFFICIENT EQUIPMENT

The Residential ERV, proposed for installation, must be listed in the Home Ventilation Institute's HVI-Certified Ratings Listing by its Brand and Model Number, and the HVI-Certified Ratings Listing must include the Model's Maximum CFM, ASRE (Adjusted Sensible Recovery Efficiency) and ATRE (Adjusted Total Recovery Efficiency) ratings values.

DEFINITION OF BASELINE EQUIPMENT

The baseline equipment is a residential HVAC system with no energy recovery ventilator installed.

DEEMED LIFETIME OF EFFICIENT EQUIPMENT

The expected measure life of an ERV is estimated as 15 Years.⁷⁵³

DEEMED MEASURE COST

The actual cost of the ERV should be used. If unknown assume an incremental measure cost of \$25.00 per Maximum CFM HVI-Certified Rating of proposed Brand and Model Number.⁷⁵⁴

LOADSHAPE

R11 - Residential Ventilation

⁷⁵³ State of Minnesota Technical Reference Manual, version 3, pp. 350+.

<https://mn.gov/commerce/industries/energy/utilities/cip/technical-reference-manual/>

⁷⁵⁴ This installed cost amount is estimated by Leidos based on 2Q2021 list prices from SupplyHouse.com for a variety of ERVs of nominally 95-117 CFM capacity plus an estimated \$2,000 per ERV for electrical and mechanical installation services, divided by the Maximum listed CFM specified in the Home Ventilating Institute's Certified Products Directory for the specific ERVs offered by SupplyHouse.com. Unit installed prices ranged from \$24.27 to \$28.93 per CFM based on the above.

COINCIDENCE FACTOR

The summer peak coincidence factor for cooling is provided in two different ways below. The first is used to estimate peak savings during the utility peak hour and is most indicative of actual peak benefits, and the second represents the *average* savings over the defined summer peak period and is presented so that savings can be bid into PJM’s Forward Capacity Market.

- CF_{SSP SF} = Summer System Peak Coincidence Factor for ERV (during utility peak hour)
= 95%⁷⁵⁵
- CF_{PJM SF} = PJM Summer Peak Coincidence Factor for ERV (average during PJM peak period)
= 95%⁷⁵⁶

Algorithm

CALCULATION OF ENERGY SAVINGS

ELECTRIC ENERGY SAVINGS

ERV Electric Heating Savings

If residence uses Electric heating,

$$\Delta kWh_{heating} = 1.08 * HVI_Max_CFM * HDD60 * 24 * HVI_Rated_ASRE / \eta_{Heat} / 3412 * Daily_Hrs_Ventilation / 24 * \%ElectricHeat$$

Where:

- 1.08 = Specific heat of air x density of inlet air @ 70F x 60 min/hr in BTU/hr-F-CFM
- HVI_Max_CFM = HVI-Certified Maximum CFM of the Brand/Model of ERV proposed to be used⁷⁵⁷

If ERV Brand and Model are unknown, use the appropriate values in following Table of ERV Default Values⁷⁵⁸:

ERV Default Values:

	ERV Default Heating and Cooling CFM	ERV Default ASRE	ERV Default ATRE	ERV Default Watts
Single-family	114	70%	56%	94
Multi-family	64	65%	53%	49
Unknown Residence ⁷⁵⁹	99	68%	55%	80
Custom	<i>Actual</i>	<i>Actual</i>	<i>Actual</i>	<i>Actual</i>

HDD60 = Heating Degree Days, base 60F, for the Climate Zone of Customer’s site, from the

⁷⁵⁵ Based on 24 hr /day, 7 day/w operation.

⁷⁵⁶ Ibid.

⁷⁵⁷ Please see file ‘HVIProd_ER.xlsx’ for all related values. This is a lookup based on Customer inputs of ERV Brand and Model Number, which must match one of the HVI-Certified listings.

⁷⁵⁸ Table of ERV Default Values is based on all available ERV Certified Data from file ‘HVIProd_ER.xlsx’ published by Home Ventilating Institute (<https://www.hvi.org/hvi-certified-products-directory/section-iii-hrv-erv-directory-listing/>). This table lists certified values of 387 models of ERVs. The default values above assume that Single-family residences will install ERVs with Heating CFM > 75 and Multi-family residences will install ERVs with Heating CFM <= 75 cfm. The respective default values represent arithmetic averages of the respective HVI ERV values separated into these two ERV CFM ranges.

⁷⁵⁹Table HC2.9 Structural and Geographic Characteristics of Homes in Midwest Region, Divisions, and States, 2009. 69% Multi-Family and 31% Single Family.

following Table ⁷⁶⁰

Table 1: Climate Variables

Climate Zone (City based upon)	Climate Heating Factor (CHF)	Heating based on Sensible: HDD60	Cooling based on Sensible: CDD65	Heating Design Day DBT	Cooling Design Day DBT	Cooling Design Day OA Enthalpy	Heating Design Day OA Enthalpy	Cooling Design Day RA Enthalpy	Heating Design Day RA Enthalpy	Δ Enthalpy ⁷⁶¹ (Btu-hr/lb)	Daily fan use ⁷⁶²
1 (Rockford)	58%	5,230	877	0.3	88.0	41.0	0.07	28.36	25.34	6,375	17.8
2 (Chicago)	55%	4,798	1,047	4.4	88.5	40.8	1.06	28.36	25.34	7,243	18.9
3 (Springfield)	48%	4,266	1,183	7.3	90.7	42.8	1.75	28.36	25.34	11,311	18.9
4 (Belleville)	49%	3,188	1,641	12.7	92.7	43.3	3.05	28.36	25.34	11,885	18.4
5 (Marion)	46%	3,390	1,450	12.1	92.7	44.5	2.90	28.36	25.34	11,885	18.4

24 = Number of Hours in a Day ⁷⁶³

HVI_Rated_ASRE = HVI-Certified Adjusted Sensible Recovery Efficiency of the Brand/Model of ERV proposed to be used⁷⁶⁴

= If ERV Brand and Model are unknown, use default values in previous table of ERV Default Values.

η Heat = Efficiency of heating system

= Actual (where new or where it is possible to measure or reasonably estimate, assuming heat pump 85% distribution efficiency if only equipment efficiency is available). If using rated efficiencies, derate efficiency value by 1% per year (maximum of 30 years) to account for degradation over time,⁷⁶⁵ or if not available refer to default table below⁷⁶⁶. If unknown value is used, it should not be derated by age.

System Type	Age of Equipment	HSPF2 Estimate	η Heat (Effective COP Estimate)= (HSPF2/3.413)*0.85
Heat Pump (if age unknown assume 2006-2014)	Before 2006	5.8	1.44
	2006 - 2014	6.5	1.62
	2015 on	7.0	1.74
Resistance	N/A	N/A	1

⁷⁶⁰ National Climatic Data Center, Cooling Degree Days are based on a base temp of 65°F and Heating Degree Days are based on a base temp of 60F. There is a county mapping table Volume 1, Section 3.7 providing the appropriate city to use for each county of Illinois.

⁷⁶¹ Base: 28.4 BTU/lb Return Air

⁷⁶² Based on defrost oversizing factor.

⁷⁶³ Used to convert Annual HDD (F-Days) to total deltaT-hours (F-Hr) per year. Also used to convert daily ERV run hours to % runtime.

⁷⁶⁴ Please see file 'HVIProd_ER.xlsx' for all related values. This is a lookup based on Customer inputs of ERV Brand and Model Number, which must match one of the HVI-Certified listings.

⁷⁶⁵ Justification for degradation factors can be found on page 14 of 'AIC HVAC Metering Study Memo FINAL 2_28_2018'. Estimate efficiency as (Rated Efficiency * (1-0.01)^Equipment Age).

⁷⁶⁶ These default system efficiencies are based on the applicable minimum Federal Standards. In 2006 the Federal Standard for Heat Pumps was adjusted. While one would expect the average system efficiency to be higher than this minimum, the likely degradation of efficiencies over time means that using the minimum standard is appropriate. An 85% distribution efficiency is then applied to account for duct losses for heat pumps.

System Type	Age of Equipment	HSPF2 Estimate	η_{Heat} (Effective COP Estimate)= $(\text{HSPF2}/3.413)*0.85$
Unknown (for use in program evaluation only) ⁷⁶⁷	N/A	N/A	1.28

3412 = Converts Btu to kWh

Daily_Hrs_Ventilation = Average annual daily ERV run time during which heat/cooling is being recovered, based on the assumption that ERV is selected to provide adequate ventilation rate when operated continuously on the coldest day of the year, when the defrost cycle interrupts heat recovery for a period of time depending on outdoor air temperature. ERV is assumed to be oversized so that on this coldest day, the ERV will provide the total ventilation air quantity during the minutes that is not in defrost. As an example, if a coldest day results in 20% defrost time, the ERV is assumed to be selected at 1/0.8 or 125% oversizing. On the coldest day, the fan would operate 100% of the time. When not in defrost, it is assumed the homeowner would reduced fan operation to 80% runtime to avoid overventilating the residence. This assumed behavior results in an average annual runtime per day ranging from 17.8 to 18.9 hours/day.

The following defrost schedule is typical of ERV manufacturers and was used to calculate average daily run hours:

OA DBT	Defrost	On	Total	% Runtime
27 F	3.0 Min.	25.0 Min.	28.0 Min.	89.3%
-4 F	4.5 Min.	17.0 Min.	21.5 Min.	79.1%
-31 F	7.0 Min.	15.0 Min.	22.0 Min.	68.2%

%ElectricHeat = Percent of homes that have electric space heating

= 100 % for Electric Resistance or Heat Pump

= 0 % for Natural Gas

= If unknown⁷⁶⁸, use the following table:

Utility	Location				
	Single Family	Single Family Low Income	Multi Family	Multi Family Low Income	Unknown
Ameren	18%	26%	38%	39%	29%
ComEd	14%	22%	43%	48%	21%
PGL	1.0%	1.5%	4.0%	2.8%	2.2%
NSG	1.3%	0.8%	32.5%	1.2%	3.3%
Nicor	1.3%	0.8%	32.5%	1.2%	3.3%

⁷⁶⁷ Calculation assumes 35% Heat Pump and 65% Resistance, which is based upon data from Energy Information Administration, 2009 Residential Energy Consumption Survey, see "HC6.9 Space Heating in Midwest Region.xls", using average for East North Central Region. Average efficiency of heat pump is based on assumption that 50% are units from before 2006 and 50% from 2006-2014. Program or evaluation data should be used to improve this assumption if available.

⁷⁶⁸ Based on the average % Natural Gas used for space heating in Unknown residential structure types across all utilities covered by the IL program. Residence types include: SF, SF LI, MF & MF LI. Utilities included: Ameren, ComEd, People’s Gas, Northshore Gas & Nicor. Data provided from 2016 Ameren Illinois Demand Side Management (DSM) Market Potential Study by Applied Energy Group, ComEd’s 2019 Baseline Survey on residential space heating share, and PY2022-2023 Implementation Contractors Data for People’s Gas, Northshore Gas & Nicor .

Utility	Location				
	Single Family	Single Family Low Income	Multi Family	Multi Family Low Income	Unknown
All DUs ⁷⁶⁹					26%

Note: If a measure is supported by a gas and electric utility through a joint program, and it is unknown whether the participant has a gas supply, the electric utility values in the table above should be used. If it is known that the participant has a gas supply, the values from the gas utility above should be applied.

For example, assuming HVI Max CFM = 117 cfm; HDD60 = 5,552 (Rockford, IL); Electric Resistance Heat (COP=1.0); HVI Rated ASRE = 75%; Heating COP = 1.0; Daily_Hrs_Ventilation = 17.8; %ElectricHeat = 100%

$$\Delta\text{kWh}_{\text{heating}} = ((1.08 * 117 * 5,552 * 24) * 75\% / 1.0 / 3,412) * 17.8 / 24 * 100\%$$

$$= 2,742 \text{ kWh of heating energy saved}$$

ERV Electric Cooling Savings

If residence uses Electric cooling, the cooling savings is calculated by the following equation:

$$\Delta\text{kWh}_{\text{cooling}} = 4.5 * \text{HVI_Max_CFM} * \Delta\text{Enthalpy} * \text{HVI_Rated_ATRE} / 1000 / \eta_{\text{Cool}} * \text{Daily_Hrs_Ventilation} / 24 * \% \text{Cool}$$

Where:

4.5 = Density of inlet air at 70F x 60 min/hr in lb-min/ft³ -hr

HVI_Max_CFM = HVI-Certified Maximum CFM of the Brand/Model of ERV proposed to be used⁷⁷⁰

= If ERV Brand and Model are unknown, use default values in previous “Table of ERV Default Values”.

ΔEnthalpy = Difference between Outdoor Air and Return Air Enthalpies (Btu/lb air) for each weather bin of the Climate Zone of Customer’s site⁷⁷¹ times the number of hours of occurrence per year of each weather bin

= Values contained in Table 1, above, for 5 representative climate zones

= $\sum [(H_{OA_Cool_{bin}} - H_{RA_Cool_{bin}}) * \text{Annual Hours}_{bin}]$ summed over all temperature bins where $H_{OA_Cool_{bin}} > H_{RA_Cool_{bin}}$.

Where:

H_{OA_Cool} = Weather Bin Outdoor Air Enthalpy

H_{RA_Cool} = Cooling Mode Return Air Enthalpy = 28.36 Btu/lb, a deemed value.

⁷⁶⁹ For the weighted average calculations, please see the Analysis file. PGL, NSG, Nicor & gas customers were assumed to follow the provided split. ComEd total customers, minus overlap with PGL,NSG & Nicor, therefore electric only homes. Ameren is total customers minus Nicor.

⁷⁷⁰ Please see HVI Table at the end of this document. This is a lookup based on Customer inputs of ERV Brand and Model Number, which must match one of the HVI-Certified listings”.

⁷⁷¹ This is based the Climate Zone based on the Customer’s Site Address, informed by the Minnesota Technical Reference Manual v.3, page 350, commercial ERV measure assumptions modified for Illinois climate conditions using ASHRAE Design Data Tables. The table recreates enthalpy assumptions originating in the Minnesota TRM v3 for commercial ERV measure, page 350, tables 1 and 2, modified for Illinois climate conditions

- 1000 = Conversion of btu to kbtu.
- η_{Cool} = Seasonal Cooling = Efficiency (SEER2) of Air Conditioning equipment (kBtu/kWh)
 = Actual (where new or where it is possible to measure or reasonably estimate). If using rated efficiencies, derate efficiency value by 1% per year (maximum of 30 years) to account for degradation over time,⁷⁷² or if unknown assume the following.⁷⁷³ If unknown value is used, it should not be derated by age.

Age of Equipment	SEER2 Estimate
Window Air Conditioner	8.6
Central AC before 2006	9.5
Central AC 2006 - 2014	12.4
Central AC After 1/1/2015	12.4
Heat Pump After 1/1/2015	13.3
Unknown (for use in program evaluation only)	10.0

HVI_Rated_ATRE = HVI-Certified Adjusted Total Heat Recovery Efficiency of the Brand/Model of ERV proposed to be used⁷⁷⁴.

Daily_Hrs_Ventilation = As previously defined

24 = Hours in a day

%Cool = Percent of homes that have cooling

Is Residence Cooled?	%Cool
Yes	100%
No	0%
Unknown (for use in program evaluation only) ⁷⁷⁵	66%

For example, assuming HVI Max CFM = 117 cfm; Δ Enthalpy = 6,375 BTU-hr/lb (Rockford, IL); Air Conditioner, vintage older than 2006 (η_{Cool} = 9.3); HVI Rated ATRE = 48%; Daily_Hrs_Ventilation = 17.8; %Cool = 100%

$$\Delta kWh_{cooling} = 4.5 * 117 * 6,375 / 1,000 / 9.3 * 48\% * 17.8 / 24 * 100\% = 128 kWh$$

ERV Fan Energy Savings

For all heating or heating/cooling ERV applications, the ERV fan savings represents the change in energy usage of the ERV fan annual energy use versus the base case standard (non-ERV) exhaust fan energy use.

The base case non-ERV exhaust fan energy use is deemed to be equal to the average ERV daily exhaust volume of

⁷⁷² Justification for degradation factors can be found on page 14 of ‘AIC HVAC Metering Study Memo FINAL 2_28_2018’. Estimate efficiency as (Rated Efficiency * (1-0.01)^Equipment Age).

⁷⁷³ These default system efficiencies are based on the applicable minimum Federal Standards. In 2006 the Federal Standard for Central AC was adjusted. While one would expect the average system efficiency to be higher than this minimum, the likely degradation of efficiencies over time mean that using the minimum standard is appropriate. Note all ratings have been converted to SEER2 equivalents – since the new rating better reflects the actual efficiency of the units.

⁷⁷⁴ Please see file ‘HVIProd_ER.xlsx’ for all related values. This is a lookup based on Customer inputs of ERV Brand and Model Number, which must match one of the HVI-Certified listings.

⁷⁷⁵ Percentage of homes in Illinois that have central cooling from “Table HC7.9 Air Conditioning in Homes in Midwest Region, Divisions, and States, 2009” from Energy Information Administration, 2009 Residential Energy Consumption Survey

air exhausted, times the deemed fan efficiency of a continuously-operated bathroom exhaust fan, as defined in Section 5.3.9 of IL-TRM_Effective_010122_v10.0_Vol_3_Res_08062021_DRAFT.docx: 1.7 CFM/Watt. The daily average total exhaust volume of the existing bathroom exhaust fan(s) is deemed to be equal to the proposed ERV daily average total exhaust volume, after taking into account the defrost cycle periods wherein ERV fan energy is consumed but no ventilation occurs.

Therefore:

$$\text{Exist_Exh_Fan_Use} = \text{HVI_Rated_CFM} * \text{Daily_Hrs_Ventilation} / 24 / 1.7 \text{ CFM/Watt} / 1000 * \text{Daily_Hrs_Fan_Use} * 365.25$$

Where:

HVI_Rated_CFM = HVI-Certified Heating CFM at Maximum Air Flow of the Brand/Model of ERV proposed to be used⁷⁷⁶

= If ERV Brand and Model are unknown, use default values in previous “Table of ERV Default Values”.

Daily_Hrs_Ventilation = As previously defined.

1.7 CFM/Watt = Deemed base case bathroom exhaust fan efficiency

24 = Hours in a Day

Daily_Hrs_Fan_Use = Deemed 24 hr/day because of continuous ERV fan use whether ERV is in defrost cycle or in ventilation cycle

365.25 = Days in a Year

1000 = Conversion of watts to kW

8766 = Annual Hours of Bathroom Fan Use

$$\text{ERV_Fan_Use} = \text{HVI_Rated_W} / 1000 * \text{Daily_Hrs_Fan_Use} * 365$$

Where:

HVI_Rated_W = HVI-Certified Wattage at Maximum Air Flow of the Brand/Model of ERV proposed to be used⁷⁷⁷

= If ERV Brand and Model are unknown, use default Watts/CFM in previous “Table of ERV Default Values” x ERV CFM (also from “Table of ERV Default Values”).

1000 = Conversion of watts to kW

Daily_Hrs_Fan_Use = Deemed to be 24 hr/day because of continuous ERV fan use whether ERV is in defrost cycle or in ventilation cycle.

Savings (positive or negative) therefore are calculated by the following equation:

$$\text{Exist_Exh_Fan_Use} - \text{ERV_Fan_Use}$$

Where both terms in the equation are as previously defined.

⁷⁷⁶ Please see file ‘HVIProd_ER.xlsx’ for all related values. This is a lookup based on Customer inputs of ERV Brand and Model Number, which must match one of the HVI-Certified listings.

⁷⁷⁷ Please see file ‘HVIProd_ER.xlsx’ for all related values. This is a lookup based on Customer inputs of ERV Brand and Model Number, which must match one of the HVI-Certified listings”.

For Example, assuming HVI_Rated_CFM = 117 CFM; HVI Rated Watts = 106 W; Daily_Hrs_Ventilation = 17.8; Daily_Hrs_Fan_Use = 24; Base Case Bathroom Exhaust Fan Efficiency = 1.7 CFM/Watt.

$$\text{Exist_Exh_Fan_Use} = 117 * 17.8 / 24 / 1.7 / 1000 * 24 * 365.25 = 447 \text{ kWh/Year}$$

$$\text{ERV_Fan_Use} = 106 / 1,000 * 24 * 365.25 = 929 \text{ kWh}$$

$$\text{ERV Fan Energy Savings} = 447 \text{ kWh} - 929 \text{ kWh} = - (482) \text{ kWh}$$

SUMMER COINCIDENT PEAK DEMAND SAVINGS

$$\Delta kW = \Delta kWh_{\text{Annual}} / \text{HOU} * \text{CF} * \text{Daily_Hrs_Ventilation} / 24$$

Where:

$$\Delta kWh_{\text{Annual}} = \Delta kWh_{\text{heating}} + \Delta kWh_{\text{cooling}}$$

HOU = Annual Hours of Use of ERV, including defrost hours where fan recirculates indoor air through outdoor air heat exchanger.

= Actual. Use 8,766 hours/year if actual is not available.⁷⁷⁸

CF_{SSP SF} = Summer System Peak Coincidence Factor for ERV (during utility peak hour)

= 95%⁷⁷⁹

CF_{PJM SF} = PJM Summer Peak Coincidence Factor for ERV (average during PJM peak period)

= 95%⁷⁸⁰

Daily_Hrs_Ventilation = As defined previously.

24 = Hours in a day

For example, assuming Annual kWh Saved = 1,989 kWh/year; HOU = 8,766 Hr/Yr; CF = 0.95; Daily_hr_use = 17.8

$$\Delta kW = 1,989 / 8,766 * 0.95 * 17.8 / 24$$

$$= 0.16 \text{ kW}$$

FOSSIL FUEL SAVINGS

$$\Delta \text{Therms}_{\text{Annual}} = 1.08 * \text{HVI_Max_CFM} * \text{HDD60} * 24 * \text{HVI_Rated_ASRE} / \eta_{\text{Heat}} / 100,000 * \text{Daily_Hrs_Ventilation} / 24 * \% \text{FossilHeat}$$

Where:

1.08 = Conversion of CFM air * delta T to BTU/hr

HVI_Max_CFM = HVI-Certified Maximum CFM of the Brand/Model of ERV proposed to be used⁷⁸¹

⁷⁷⁸ Deemed continual operation of ERV throughout year.

⁷⁷⁹ Based on 24 hr /day, 7 day/w operation.

⁷⁸⁰ Ibid.

⁷⁸¹ Please see file 'HVIProd_ER.xlsx' for all related values. This is a lookup based on Customer inputs of ERV Brand and Model Number, which must match one of the HVI-Certified listings.

- HDD60 = Heating Degree Days base 60F, for the Climate Zone of Customer’s site
= Value obtained from Table 1, above.
- 24 = Converts Days to Hours⁷⁸²
- HVI_Rated_ASRE = HVI-Certified Adjusted Sensible Recovery Efficiency of the Brand/Model of ERV proposed to be used⁷⁸³
= If ERV Brand and Model are unknown, use default values in previous table of ERV Default Values.
- η Heat = Efficiency of heating system
= Equipment efficiency * distribution efficiency
= Actual (where new or where it is possible to measure or reasonably estimate, assuming 85% distribution efficiency if only equipment efficiency is available).⁷⁸⁴ If using rated efficiencies, derate efficiency value by 1% per year (maximum of 30 years) to account for degradation over time,⁷⁸⁵ or if Equipment Efficiency is not available, use Section 5.3 to select the appropriate equipment efficiency for the project. If unknown value is used, it should not be derated by age.
- 100,000 = Converts Btu/hr to Therms
- %FossilHeat = Percent of homes that have fossil fuel space heating
= 100 % for fossil fuel
= 0 % for Electric Resistance or Heat Pump
= If unknown⁷⁸⁶, use the following table:

Utility	Location				
	Single Family	Single Family Low Income	Multi Family	Multi Family Low Income	Unknown
Ameren	82%	74%	62%	61%	71%
ComEd	86%	78%	57%	52%	79%
PGL	98.9%	98.5%	96.0%	96.9%	97.7%
NSG	98.3%	99.2%	67.5%	98.8%	96.6%
Nicor	98.3%	99.2%	67.5%	98.8%	96.6%
All DUs⁷⁸⁷					74%

Note: If a measure is supported by a gas and electric utility through a joint program, and it is unknown

⁷⁸² Used to convert Annual HDD (F-Days) to total deltaT-hours (F-Hr) per year.

⁷⁸³ Please see file ‘HVIProd_ER.xlsx’ for all related values. This is a lookup based on Customer inputs of ERV Brand and Model Number, which must match one of the HVI-Certified listings.

⁷⁸⁴ Ideally, the System Efficiency should be obtained either by recording the AFUE of the unit, or performing a steady state efficiency test. The Distribution Efficiency can be estimated via a visual inspection and by referring to a look up table such as that provided by the Building Performance Institute: (see ‘BPI Distribution Efficiency Table’) or by performing duct blaster testing.

⁷⁸⁵ Justification for degradation factors can be found on page 14 of ‘AIC HVAC Metering Study Memo FINAL 2_28_2018’. Estimate efficiency as (Rated Efficiency * (1-0.01)^{Equipment Age}).

⁷⁸⁶ Based on the average % Natural Gas used for space heating in Unknown residential structure types across all utilities covered by the IL program. Residence types include: SF, SF LI, MF & MF LI. Utilities included: Ameren, ComEd, People’s Gas, Northshore Gas & Nicor. Data provided from 2016 Ameren Illinois Demand Side Management (DSM) Market Potential Study by Applied Energy Group, ComEd’s 2019 Baseline Survey on residential space heating share, and PY2022-2023 Implementation Contractors Data for People’s Gas, Northshore Gas & Nicor .

⁷⁸⁷ For the weighted average calculations, please see the Analysis file. PGL, NSG, Nicor & gas customers were assumed to follow the provided split. ComEd total customers, minus overlap with PGL,NSG & Nicor, therefore gas only homes. Ameren is total customers minus Nicor.

whether the participant has a gas supply, the electric utility values in the table above should be used. If it is known that the participant has a gas supply, the values from the gas utility above should be applied.

Other factors as defined above.

For example, assuming: HVI_Max_CFM =117; HDD60 = 5,552; HVI_Rated_ASRE = 75%; $\eta_{\text{Heat}} = 0.80$ (Non-condensing Gas Heat); Daily_Hrs_Ventilation = 17.8, then

$$\begin{aligned}\Delta\text{Therms}_{\text{Annual}} &= 1.08 * 117 * 5,552 * 24 * 75\% / 0.80 / 100,000 * 17.8 / 24 \\ &= 117 \text{ Therms}\end{aligned}$$

WATER AND OTHER NON-ENERGY IMPACT DESCRIPTIONS AND CALCULATION

N/A

DEEMED O&M COST ADJUSTMENT CALCULATION

N/A

MEASURE CODE: RS-HVC-ERVS-V04-250101

REVIEW DEADLINE: 1/1/2029

5.3.21 Air Handler Filter Cleaning/Replacement

DESCRIPTION

A dirty air handler filter increases electricity consumption for circulating fans and decreases system heating and cooling efficiencies. This measure characterizes a direct install style program whereby an existing dirty filter is either cleaned or replaced. This measure applies to central forced-air furnaces, central AC and heat pump systems. Where homes do not have central cooling, only the annual heating savings will apply.

This measure was developed to be applicable to the following program types: DI. If applied to other program types, the measure savings should be verified.

DEFINITION OF EFFICIENT EQUIPMENT

The efficient condition is a cleaned or replaced air handler filter.

DEFINITION OF BASELINE EQUIPMENT

The baseline condition is an air handler filter with dirt build up and result in a blower fan motor working harder and the heating/cooling system efficiency degrading.

DEEMED LIFETIME OF EFFICIENT EQUIPMENT

The expected measure life is assumed to be 3 years⁷⁸⁸.

DEEMED MEASURE COST

The actual measure cost to clean or replace the filter should be used. If costs are unavailable assume \$30 for a filter clean (assuming ½ hour at \$60 an hour) or \$50 for a new filter (\$20 for the filter plus ½ hour at \$60 an hour).

LOADSHAPE

Loadshape R10 - Residential Electric Heating and Cooling

Loadshape R09 - Residential Electric Space Heat

COINCIDENCE FACTOR

The summer peak coincidence factor for cooling is provided in two different ways below. The first is used to estimate peak savings during the utility peak hour and is most indicative of actual peak benefits, and the second represents the *average* savings over the defined summer peak period, and is presented so that savings can be bid into PJM’s Forward Capacity Market.

CF_{SSP} = Summer System Peak Coincidence Factor for Central A/C (during system peak hour)
 = 68%⁷⁸⁹

CF_{PJM} = PJM Summer Peak Coincidence Factor for Central A/C (average during PJM peak period)
 = 46.6%⁷⁹⁰

Algorithm

⁷⁸⁸ Consistent with furnace tune-up measure.

⁷⁸⁹ Based on metering of 24 homes with central AC during PY4 and PY5 in Ameren Illinois service territory.

⁷⁹⁰ Based on analysis of Itron eShape data for Missouri, calibrated to Illinois loads, supplied by Ameren. The average AC load over the PJM peak period (1-5pm, M-F, June through August) is divided by the maximum AC load during the year.

CALCULATION OF ENERGY SAVINGS

ELECTRIC ENERGY SAVINGS

$$\Delta kWh = kW_{motor} * (EFLH_{heat} + (\%AC * EFLH_{cool})) * \%FanSave$$

Where:

kW_{motor} = Average air handler fan motor full load electric demand
 = 0.377 kW⁷⁹¹

$EFLH_{heat}$ = Equivalent Full Load Hours for heating. Depends on location. See table below

Climate Zone (City based upon)	$EFLH_{heat}$ ⁷⁹²
1 (Rockford)	1,520
2 (Chicago)	1,421
3 (Springfield)	1,347
4 (Belleville)	977
5 (Marion)	994
Weighted Average	1,406

$\%AC$ = Fraction of customers with thermostat-controlled air-conditioning

Thermostat control of air conditioning?	$\%AC$ ⁷⁹³
Yes	100%
No	0%
Unknown	82.5%

$EFLH_{cool}$ = Equivalent Full Load Hours for cooling. Depends on location. If no cooling, assume 0. See table below⁷⁹⁴.

Climate Zone (City based upon)	$EFLH_{cool}$
1 (Rockford)	323
2 (Chicago)	308
3 (Springfield)	468
4 (Belleville)	629

⁷⁹¹ Typical blower motor capacity for gas furnace is ¼ to ¾ HP. Midpoint is ½ HP. ½ HP × 0.746 (kW/hp)=0.377kW.

⁷⁹² *All-Electric Homes PY6 Metering Results: Multifamily HVAC Systems*, Cadmus, October 2015. FLH values are based on metering of Multifamily units that were used as the primary heating source to the whole home, and in buildings that had received weatherization improvements. A DMSHP installed in a single-family home may be used more sporadically, especially if the DMSHP serves only a room, and buildings that have not been weatherized may require longer hours. Additional evaluation is recommended to refine the EFLH assumptions for the general population.

⁷⁹³ 99% of ComEd PY8 program participants (AC targeted programs) have Central AC per communication with Navigant’s ongoing 2017/2018 cooling savings evaluation. Non-targeted programs are still expected to have participation with $\%AC$ above general population rates. 82.5% is an average of the 99% program participation rate, and the 69% of homes in Illinois having central cooling ("Table HC7.9 Air Conditioning in Homes in Midwest Region, Divisions, and States, 2009 from Energy Information Administration", 2009 Residential Energy Consumption Survey ;

⁷⁹⁴ *All-Electric Homes PY6 Metering Results: Multifamily HVAC Systems*, Cadmus, October 2015. FLH values are based on metering of Multifamily units, and in buildings that had received weatherization improvements. Additional evaluation is recommended to refine the EFLH assumptions for the general population.

Climate Zone (City based upon)	EFLH _{cool}
5 (Marion)	549
Weighted Average ⁷⁹⁵	364

%FanSave = Assumed percent fan savings
= 10%⁷⁹⁶

For example, replacing an air handler filter in a home with a gas furnace and central cooling in Chicago:

$$\begin{aligned} \Delta\text{kWh} &= 0.377 * (1,421 + (1 * 308)) * 0.1 \\ &= 65.2 \text{ kWh} \end{aligned}$$

SUMMER COINCIDENT PEAK DEMAND SAVINGS

$$\Delta\text{kW} = \text{kW}_{\text{motor}} * \%AC * \%FanSave * CF$$

Where:

CF_{SSP} = Summer System Peak Coincidence Factor for Central A/C (during system peak hour)
= 68%⁷⁹⁷

CF_{PJM} = PJM Summer Peak Coincidence Factor for Central A/C (average during peak period)
= 46.6%⁷⁹⁸

For example, replacing an air handler filter in a home with a gas furnace and central cooling in Chicago:

$$\begin{aligned} \Delta\text{kW}_{\text{SSP}} &= 0.377 * 1 * 0.1 * 0.68 \\ &= 0.0256 \text{ kW} \end{aligned}$$

FOSSIL FUEL SAVINGS

$$\Delta\text{Therms} = \%FossilHeat * \text{Gas_Heating_Consumption} * EI$$

Where:

%FossilHeat = Percentage of heating savings assumed to be Natural Gas

Heating fuel	%FossilHeat
Electric	0%
Natural Gas	100%
Unknown	97% ⁷⁹⁹

⁷⁹⁵ Weighted based on number of residential occupied housing units in each zone.

⁷⁹⁶ Based on Energy.gov website; “Maintaining Your Air Conditioner”. Accessed 7/16/2014, which states that replacing a dirty air filter with a clean one can lower total air conditioner energy consumption by 5-15%. Since most savings will be to the fan motor, assuming 10%.

⁷⁹⁷ Based on metering of 24 homes with central AC during PY4 and PY5 in Ameren Illinois service territory.

⁷⁹⁸ Based on analysis of Itron eShape data for Missouri, calibrated to Illinois loads, supplied by Ameren. The average AC load over the PJM peak period (1-5pm, M-F, June through August) is divided by the maximum AC load during the year.

⁷⁹⁹ Value used is based on known PY8 percent of electric heat provided by Navigant as part of the ongoing evaluation work source: “Slide 21: May 22, 2018, Second Addendum IL TRM Advanced Thermostat Cooling Savings Evaluation”

Gas_Heating_Consumption

= Estimate of annual household heating consumption for gas heated single-family homes. If location is unknown, assume the average below⁸⁰⁰.

Climate Zone (City based upon)	Gas_Heating_Consumption (therms)
1 (Rockford)	1,052
2 (Chicago)	1,005
3 (Springfield)	861
4 (Belleville)	664
5 (Marion)	676
Average	955

EI = Estimated savings from efficiency Improvement
= 1%⁸⁰¹

For example, replacing an air handler filter in a home with a gas furnace and central cooling in Chicago:
 $\Delta\text{Therms} = 1.0 * 1005 * 0.01$
 $= 10.1\text{therms}$

WATER AND OTHER NON-ENERGY IMPACT DESCRIPTIONS AND CALCULATION

N/A

DEEMED O&M COST ADJUSTMENT CALCULATION

N/A

MEASURE CODE: RS-HVC-AHFR-V01-230101

REVIEW DEADLINE: 1/1/2025

⁸⁰⁰ Values are based on adjusting the average household heating load (834 therms) for Chicago based on 'Table E-1, Energy Efficiency / Demand Response Nicor Gas Plan Year 1, Research Report: Furnace Metering Study', divided by standard assumption of existing unit efficiency of 83% (estimate based on 24% of furnaces purchased in Illinois were condensing in 2000 (based on data from GAMA, provided to Department of Energy), assuming typical efficiencies: $(0.24*0.92) + (0.76*0.8) = 0.83$) to give 1005 therms. This Chicago value was then adjusted to a statewide average using relative HDD assumptions to adjust for the evaluation results focus on northern region. Values for individual cities are then calculated by comparing average HDD to the individual city's HDD.

⁸⁰¹ Based on Michael Blasnik estimate of 1% gas savings for 25% air flow change; final slide of presentation: https://buildingscience.com/sites/default/files/01_Lies_Damned_Lies_and_Modeling_rev.pdf

5.3.22 High Efficiency Kitchen Exhaust Fans

DESCRIPTION

This measure will serve to capture the savings from the installation of a new kitchen exhaust fan, also known as a Range Hood, for typical usage. Existing kitchen exhaust fans may be too noisy, inefficient, or in need of replacement if beyond repair. This measure assumes fan capacities between 10 and 200 CFM rated at a sound level of maximum 2.0 sones at 0.1 inches of water column static pressure. All eligible installations shall be sized to provide the mechanical ventilation rate indicated by ASHRAE 62.2.

This measure was developed to be applicable to the following program types: TOS, NC, RF.

If applied to other program types, the measure savings should be verified.

DEFINITION OF EFFICIENT EQUIPMENT

New efficient ENERGY STAR exhaust-only ventilation fan, quiet (≤ 2.0 sones) operating in accordance with recommended ventilation rate indicated by ASHRAE 62.2 – 2016. ENERGY STAR specifications (effective October 1, 2015) are provided below:

Efficiency Level	Fan Capacity	Minimum Efficacy Level (CFM/Watts)	Maximum Allowable Sound Level (sones)
ENERGY STAR	≤ 75 W	2.8	2.0

DEFINITION OF BASELINE EQUIPMENT

New standard efficiency exhaust-only ventilation fan.

DEEMED LIFETIME OF EFFICIENT EQUIPMENT

The expected measure life is assumed to be 19 years.⁸⁰²

DEEMED MEASURE COST

Incremental cost per installed fan is \$107.⁸⁰³

LOADSHAPE

Loadshape R11 - Residential Ventilation

COINCIDENCE FACTOR

N/A

⁸⁰² Conservative estimate based upon GDS Associates Measure Life Report “Residential and C&I Lighting and HVAC measures” 25 years for whole-house fans, and 19 for thermostatically-controlled attic fans.

⁸⁰³ Analysis using cost data collected from online resources. See ‘Kitchen Exhaust Fans Supplementary Data’ workbook for more information.

Algorithm

CALCULATION OF ENERGY SAVINGS

ELECTRIC ENERGY SAVINGS

$$\Delta kWh = (CFM * (1/\eta_{BASELINE} - 1/\eta_{EFFICIENT})/1000) * Hours$$

Where:

- CFM = Nominal Capacity of the exhaust fan
= Actual or use defaults provided below
- $\eta_{BASELINE}$ = Average efficacy for baseline fan (CFM/watts)
= Actual or use defaults provided below
- $\eta_{EFFICIENT}$ = Average efficacy for efficient fan (CFM/watts)
= Actual or use defaults provided below
- Hours = assumed annual run hours of stove
= 120⁸⁰⁴

Defaults provided below:⁸⁰⁵

Average CFM	Base CFM/Watts	ENERGY STAR CFM/Watts	ΔkWh
145.5	2.4 ⁸⁰⁶	4.5	3.4

SUMMER COINCIDENT PEAK DEMAND SAVINGS

N/A

FOSSIL FUEL SAVINGS

N/A

WATER AND OTHER NON-ENERGY IMPACT DESCRIPTIONS AND CALCULATION

N/A

DEEMED O&M COST ADJUSTMENT CALCULATION

N/A

MEASURE CODE: RS-HVC-KEXF-V01-240101

REVIEW DEADLINE: 1/1/2029

⁸⁰⁴ Assumes that 50% of cooking events utilize the kitchen exhaust fan. Number of cooking events is consistent with the 5.1.14 Residential Induction Cooktop measure which assumes 1 hours per cycle and 239 cycles per year therefore 239 operating hours per year. 239 cycles per year is based on a 2016 CASE study for PG&E modeling Plug Loads.

⁸⁰⁵ Average CFM and EnergyStar CFM/Watts calculated using EnergyStar’s list of qualified products, accessed 5/2023.

⁸⁰⁶ Based on review of Range Hood products available on CEC Appliance Database, accessed 5/12/2023. See ‘Kitchen Exhaust Fans Supplementary Data’ spreadsheet, “All Fans less than 75W” tab for more details.

5.4 Hot Water End Use

5.4.1 Domestic Hot Water Pipe Insulation

DESCRIPTION

This measure describes adding insulation to un-insulated domestic hot water pipes. The measure assumes the pipe wrap is installed either to the first length of both the hot and cold pipe (this is the most cost-effective section to insulate in non-circulating systems, since the water pipes act as an extension of the hot water tank) or to a hot water recirculating loop. Insulating this length therefore helps reduce standby losses. Default savings are provided per 3ft length and are appropriate up to 6ft of the hot water pipe and 3ft of the cold. Where a hot water recirculating pump is in use, this measure is viable for the entire hot water loop.

This measure was developed to be applicable to the following program types: TOS, NC, RF, KITS.

If applied to other program types, the measure savings should be verified.

DEFINITION OF EFFICIENT EQUIPMENT

The efficient case is installing pipe wrap insulation to a length of hot water pipe.

DEFINITION OF BASELINE EQUIPMENT

The baseline is an un-insulated hot water pipe.

DEEMED LIFETIME OF EFFICIENT EQUIPMENT

The measure life is assumed to be 12 years.⁸⁰⁷

DEEMED MEASURE COST

The actual installation cost should be used if known. If unknown, the measure cost including material and installation is assumed to be \$3 per linear foot.⁸⁰⁸ For foam pipe insulation assume a measure cost of \$0.26/ft for ½" insulation and \$0.31/ft for ¾" insulation.⁸⁰⁹

LOADSHAPE

Loadshape C53 - Flat

COINCIDENCE FACTOR

This measure assumes a flat loadshape since savings relate to reducing standby losses and as such the coincidence factor is 1.

Algorithm

CALCULATION OF SAVINGS

ELECTRIC ENERGY SAVINGS

$$\Delta \text{kWh} = \% \text{Electric_DHW} * ((1 / R_{\text{exist}} - 1 / R_{\text{new}}) * C_{\text{inside}} * L_{\text{effective}} * \Delta T * 8,766 * \text{ISR}) / \eta_{\text{DHW}} / 3,412$$

Where:

$\% \text{Electric_DHW}$ = Percentage of DHW savings assumed to be electric

⁸⁰⁷ . California DEER EUL Table Update 2014-02-05. Average of values for electric DHW (13 years) and gas DHW (11 years).

⁸⁰⁸ Consistent with DEER 2008 Database Technology and Measure Cost Data (www.deeresources.com).

⁸⁰⁹ Review of website cost data for Homedepot.com, Lowes.com, and Menards.com for locations in Peoria, IL.

- = 100 % for Electric
- = 0 % for Fossil Fuel
- = If unknown⁸¹⁰, use the following table:

Utility	Location				
	Single Family	Single Family Low Income	Multi Family	Multi Family Low Income	Unknown
Ameren ⁸¹¹	24%	25%	40%	43%	28%
ComEd ⁸¹²	8%		11%		9%
People’s Gas ⁸¹³	2.0%	2.0%	1.7%	2.1%	2.0%
Northshore Gas ⁸¹⁴	1.3%	1.8%	10.0%	2.4%	2.3%
Nicor Gas ⁸¹⁵	1.3%	1.8%	10.0%	2.4%	2.3%
All DUs⁸¹⁶					25%

Note: If a measure is supported by a gas and electric utility through a joint program, and it is unknown whether the participant has a gas supply, the electric utility values in the table above should be used. If it is known that the participant has a gas supply, the values from the gas utility above should be applied.

- R_{exist}** = Pipe heat loss coefficient of uninsulated pipe (existing) [(hr-°F-ft)/Btu]
= Varies based on pipe size and material. See table below for values.
- R_{new}** = Pipe heat loss coefficient of insulated pipe (new) [(hr-°F-ft)/Btu]
= Actual (R_{exist} + R value of insulation⁸¹⁷)
- C_{inside}** = Inside circumference of the pipe [ft]
= Actual (0.5” pipe = 0.1427 ft, 0.75” pipe = 0.2055 ft); See table below for values.
- L_{effective}** = Effective length of pipe from water heating source covered by pipe insulation (ft) ⁸¹⁸
= L_{Horizontal} + αL_{Vertical}
= Actual; See table below for α values. If unknown, assume 3ft of vertical and remaining horizontal.

⁸¹⁰ Based on the average % electricity used for water heating in Unknown residential structure types across all utilities covered by the IL program. Residence types include: SF, SF LI, MF & MF LI. Utilities included: Ameren, ComEd, People’s Gas, Northshore Gas & Nicor. Please see subsequent table and citations for specific sources.

⁸¹¹ Provided by AEG from the 2020 Market Potential Study completed for AIC, as well as AIC Income Qualified Initiative: 2021 Participant Survey Results Memo (February 1, 2022) p. 17.

⁸¹² Commonwealth Edison Residential Baseline Study (2020). p.4.4 & 4.19; Section 4-7 Water Heating. Prepared by Itron.

⁸¹³ Implementation Contractors data from Peoples Gas and North Shore Gas for PY2022-2023.

⁸¹⁴ Ibid.

⁸¹⁵ Comparable service area & customers to NSG, therefore using their survey data.

⁸¹⁶ For the weighted average calculations, please see the Analysis file. PGL, NSG, Nicor & gas customers were assumed to follow the provided split. ComEd total customers, minus overlap with PGL,NSG & Nicor, therefore electric only homes. Ameren is total customers minus Nicor.

⁸¹⁷ Where possible it should be ensured that the R-value of the insulation is at the appropriate mean rating temperature (100F).

⁸¹⁸ In cases with zero wind, heat loss (and therefore) savings is larger from horizontal pipe configurations than vertical pipe configurations due, perhaps to the way in which convective losses are handled. Given that most DHW pipe insulation installations begin with a vertical orientation from the water heater, an adjustment to the engineering calculation is needed. An analysis of the 3E PLUS tool by NAIMA (<https://insulationinstitute.org/tools-resources/free-3e-plus/>) yielded adjustment factors for horizontal to vertical loss and savings values. See DHW_PipeInsulationCalcs_062121.xlsx for details of the analysis and comparisons.

ΔT	= Average temperature difference between supplied water and outside air temperature (°F) = 60°F ⁸¹⁹
8,766	= Hours per year
ISR	= In Service Rate = 0.50 for Kits distribution ⁸²⁰ , 0.78 for Virtual Assessment followed by Self-Installation ⁸²¹ , and 1.0 for Direct Install, TOS, or Verified Install program types
η_{DHW}	= Recovery efficiency of electric hot water heater = 0.98 ⁸²²
3412	= Conversion from Btu to kWh

Parameter assumptions for various pipe sizes and materials:

Type and Size	C_{inside} ⁸²³ (I.D. * π /12) (ft)	Product of Overall Heat Transfer Coefficient and Pipe Area (UA) per foot ⁸²⁴ from bare pipe (BTU/hr-ft·°F)	Pipe Area per linear foot (ft ²) ⁸²⁵	R_{exist} ((hr-ft·°F)/BTU)	Horizontal to Vertical Adjustment Factor (α)
½" Copper Pipe	0.1427	0.345	0.153	0.444	0.67
¾" Copper Pipe	0.2055	0.417	0.217	0.521	0.72
½" PEX	0.1270	0.438	0.145	0.332	0.73
¾" PEX	0.1783	0.545	0.204	0.374	0.77

⁸¹⁹ Assumes 125°F water leaving the hot water tank and average temperature of basement of 65°F.

⁸²⁰ Results from Home Energy Worksheets completed by student/families in 2020, 2021, and 2022 were nearly the same as values from: 2020 survey research by Guidehouse, conducted with Peoples Gas income qualified recipients of self-install efficiency kits distributed by mail in late 2019 (with 117 survey respondents) and research from 2021 Ameren Illinois Income Qualified participant survey, available on IL SAG website:

<https://ilsag.s3.amazonaws.com/AIC-Income-Qualified-Initiative-Participant-Survey-Results-Memo-FINAL-2022-02-01.pdf>.

Home Energy Worksheets also establish the fraction of participants who indicate they “will install later” for specific measures. Follow-up research completed by Guidehouse for Nicor Gas in 2022 found that, on average, 51.3% of respondents who initially reported that they hadn’t installed specific kit measures, but “planned to” subsequently had installed the measures. Combining these findings allows for an ISR that accounts for initial and one round of subsequent installations. To maintain a conservative estimate of ISR, the remaining 48.7% are presumed uninstalled. See: EESchoolKitSubsequentInstall_HEW.xlsx for data and calculations.

⁸²¹ An equal weighted average of Direct Install and Kit ISRs. Interest and applicability of measures confirmed through virtual assessment followed by self-installation without verification of install.

⁸²² Electric water heaters have recovery efficiency of 98%.

⁸²³ See: <https://energy-models.com/pipe-sizing-charts-tables> (last accessed 5/7/21) for copper pipe sizes and <https://www.garagesanctum.com/size-chart/pex-tubing-size-chart/> (last accessed 5/7/21) for PEX pipe sizes.

⁸²⁴ Laboratory measured values from Hoeschele and Weitzel (2012), Figure 1.

⁸²⁵ Calculated using the average pipe thickness (I.D. + O.D.)*0.5.

For example, insulating 6 feet of 0.75” copper pipe (4ft vertical + 2ft horizontal) with R-5 wrap for electric DHW through a Direct Install program:

$$\begin{aligned} \Delta kWh &= \%Electric_DHW * (((1 / R_{exist} - 1 / R_{new}) * C_{inside} * L_{effective} * \Delta T * 8,766 * 1.0) / \eta_{DHW}) / 3,412 \\ &= 1 * (((1/0.521 - 1/3.521) * 0.2055 * (2 + 4 * 0.72) * 60 * 8,766 * 1.0) / 0.98) / 3,412 \\ &= 258 kWh \end{aligned}$$

The following table provides annual energy savings per foot of pipe insulation for various configurations with electric DHW:

Measure Configuration	ΔkWh Savings per Foot of Insulation (kWh/ft)	
	Kit Distribution (ISR = 50%)	All Other Programs (ISR = 100%)
Horizontal Pipe Orientation		
½” Copper Pipe insulated with R-3, ½” thick insulation	22	44.0
¾” Copper Pipe insulated with R-3, ½” thick insulation	26.5	52.9
½” PEX insulated with R-3, ½” thick insulation	27.1	54.2
¾” PEX insulated with R-3, ½” thick insulation	33.4	66.7
Vertical Pipe Orientation		
½” Copper Pipe insulated with R-3, ½” thick insulation	14.8	29.5
¾” Copper Pipe insulated with R-3, ½” thick insulation	19.1	38.1
½” PEX insulated with R-3, ½” thick insulation	19.8	39.5
¾” PEX insulated with R-3, ½” thick insulation	25.7	51.3
Unknown		
R-3, ½” thick insulation for ½” pipes – pipe type and configuration unknown (average of vertical and horizontal configurations for ½” pipe)	20.9	41.8
R-3, ½” thick insulation for ¾” pipes – pipe type and configuration unknown (average of vertical and horizontal configurations for ¾” pipe)	26.1	52.2
Unknown pipe type (straight average) and configuration (average of all vertical and horizontal configurations) insulated with R-3, ½” thick insulation	23.5	46.9

SUMMER COINCIDENT PEAK DEMAND SAVINGS

$$\Delta kW = \Delta kWh / 8766$$

Where:

ΔkWh = kWh savings from pipe wrap installation

8766 = Number of hours in a year (since savings are assumed to be constant over year).

For example, insulating 6 feet of 0.75” copper pipe (4ft vertical + 2ft horizontal) with R-5 wrap through a Direct Install program:

$$\begin{aligned} \Delta kW &= 258/8766 \\ &= 0.0294kW \end{aligned}$$

The following table provides peak demand savings per foot of pipe insulation for various configurations with electric DHW:

Measure Configuration	ΔkW Savings per Foot of Insulation (kW/ft)	
	Kit Distribution (ISR = 50%)	All Other Programs (ISR = 100%)
Horizontal Pipe Orientation		
½” Copper Pipe insulated with R-3, ½” thick insulation	0.0025	0.0050
¾” Copper Pipe insulated with R-3, ½” thick insulation	0.0030	0.0060
½” PEX insulated with R-3, ½” thick insulation	0.0031	0.0062
¾” PEX insulated with R-3, ½” thick insulation	0.0038	0.0076
Vertical Pipe Orientation		
½” Copper Pipe insulated with R-3, ½” thick insulation	0.0017	0.0034
¾” Copper Pipe insulated with R-3, ½” thick insulation	0.0022	0.0043
½” PEX insulated with R-3, ½” thick insulation	0.0023	0.0045
¾” PEX insulated with R-3, ½” thick insulation	0.0030	0.0059
Unknown		
R-3, ½” thick insulation for ½” pipes – pipe type and configuration unknown (average of vertical and horizontal configurations for ½” pipe)	0.0024	0.0048
R-3, ½” thick insulation for ¾” pipes – pipe type and configuration unknown (average of vertical and horizontal configurations for ¾” pipe)	0.0030	0.0060
Unknown pipe type (straight average) and configuration (average of vertical and horizontal configurations for all pipes) insulated with R-3, ½” thick insulation	0.0027	0.0053

FOSSIL FUEL SAVINGS

For Natural Gas DHW systems:

$$\Delta_{Therm} = \%Fossil_DHW * (((1 / R_{exist} - 1 / R_{new}) * C_{inside} * L_{effective} * \Delta T * 8,766 * ISR) / \eta_{DHW}) / 100,000$$

Where:

- %Fossil_DHW = Percentage of DHW savings assumed to be fossil fuel
- = 100 % for Fossil Fuel
- = 0 % for Electric

= If unknown⁸²⁶, use the following table:

Utility	Location				
	Single Family	Single Family Low Income	Multi Family	Multi Family Low Income	Unknown
Ameren ⁸²⁷	76%	75%	60%	57%	72%
ComEd ⁸²⁸	92%		89%		91%
People’s Gas ⁸²⁹	97.9%	98.0%	98.3%	97.6%	97.8%
Northshore Gas ⁸³⁰	98.5%	98.2%	90.0%	97.6%	97.6%
Nicor Gas ⁸³¹	98.5%	98.2%	90.0%	97.6%	97.6%
All DUs⁸³²					75%

Note: If a measure is supported by a gas and electric utility through a joint program, and it is unknown whether the participant has a gas supply, the electric utility values in the table above should be used. If it is known that the participant has a gas supply, the values from the gas utility above should be applied.

η_{DHW} = Recovery efficiency of fossil hot water heater
 = 0.78⁸³³

Other variables as defined above

For example, insulating 6 feet of 0.75” copper pipe (4ft vertical + 2ft horizontal) with R-5 wrap for Gas DHW through a Direct Install program:

$$\Delta Therm = \%Fossil_DHW * ((1 / R_{exist} - 1 / R_{new}) * C_{inside} * L_{effective} * \Delta T * 8,766 * ISR) / \eta_{DHW} / 100,000$$

$$= 1 * ((1/0.521 - 1/3.521) * 0.2055 * (2 + 4 * 0.72) * 60 * 8766 * 1.0) / 0.78 / 100,000$$

$$= 11.06 \text{ therms}$$

The following table provides Natural Gas savings per foot of pipe insulation for various configurations for natural gas DHW:

Measure Configuration	Δ Therm Savings per Foot of Insulation (Therms/ft)	
	Kit Distribution (ISR = 50%)	All Other Programs (ISR = 100%)
Horizontal Pipe Orientation		

⁸²⁶ Based on the average % electricity used for water heating in Unknown residential structure types across all utilities covered by the IL program. Residence types include: SF, SF LI, MF & MF LI. Utilities included: Ameren, ComEd, People’s Gas, Northshore Gas & Nicor. Please see subsequent table and citations for specific sources.

⁸²⁷ Provided by AEG from the 2020 Market Potential Study completed for AIC, as well as AIC Income Qualified Initiative: 2021 Participant Survey Results Memo (February 1, 2022) p. 17.

⁸²⁸ Commonwealth Edison Residential Baseline Study (2020). p.4.4 & 4.19; Section 4-7 Water Heating. Prepared by Itron.

⁸²⁹ Residential Appliance Saturation Survey of natural gas for space heating and water heating (2021). Note, Multifamily customers have a residential billing rate code and responded on the survey that they live in an apartment or condominium in a building that has either 2-4 or 5+ units.

⁸³⁰ Ibid.

⁸³¹ Comparable service area & customers to NSG, therefore using their survey data.

⁸³² For the weighted average calculations, please see the Analysis file. PGL, NSG, Nicor & gas customers were assumed to follow the provided split. ComEd total customers, minus overlap with PGL,NSG & Nicor, therefore gas only homes. Ameren is total customers minus Nicor.

⁸³³ Review of AHRI Directory suggests range of recovery efficiency ratings for new Gas DHW units of 70-87%. Average of existing units is estimated at 78%

Measure Configuration	ΔTherm Savings per Foot of Insulation (Therms/ft)	
	Kit Distribution (ISR = 50%)	All Other Programs (ISR = 100%)
½" Copper Pipe insulated with R-3, ½" thick insulation	0.95	1.89
¾" Copper Pipe insulated with R-3, ½" thick insulation	1.14	2.27
½" PEX insulated with R-3, ½" thick insulation	1.16	2.32
¾" PEX insulated with R-3, ½" thick insulation	1.43	2.86
Vertical Pipe Orientation		
½" Copper Pipe insulated with R-3, ½" thick insulation	0.63	1.26
¾" Copper Pipe insulated with R-3, ½" thick insulation	0.82	1.63
½" PEX insulated with R-3, ½" thick insulation	0.85	1.70
¾" PEX insulated with R-3, ½" thick insulation	1.1	2.20
Unknown		
R-3, ½" thick insulation for ½" pipes – pipe type and configuration unknown (average of vertical and horizontal configurations for ½" pipe)	0.9	1.79
R-3, ½" thick insulation for ¾" pipes – pipe type and configuration unknown (average of vertical and horizontal configurations for ¾" pipe)	1.12	2.24
Unknown pipe type (straight average) and configuration (average of vertical and horizontal configurations for all pipes) insulated with R-3, ½" thick insulation	1.01	2.01

WATER IMPACT DESCRIPTIONS AND CALCULATION

N/A

DEEMED O&M COST ADJUSTMENT CALCULATION

N/A

MEASURE CODE: RS-HWE-PINS-V09-250101

REVIEW DEADLINE: 1/1/2028

5.4.2 Gas Water Heater

DESCRIPTION

This measure characterizes:

- a) Time of sale or new construction:

The purchase and installation of a new efficient gas-fired water heater, in place of a Federal Standard unit in a residential setting. Savings are provided for power-vented, condensing storage, and whole-house tankless units meeting specific Uniform Energy Factor (UEF) criteria.

- b) Early replacement:

The early removal of an existing functioning natural gas water heater from service, prior to its natural end of life, and replacement with a new high efficiency unit. Savings are calculated between existing unit and efficient unit consumption during the remaining life of the existing unit, and between new baseline unit and efficient unit consumption for the remainder of the measure life.

This measure was developed to be applicable to the following program types: TOS, NC, EREP.

If applied to other program types, the measure savings should be verified.

DEFINITION OF EFFICIENT EQUIPMENT

To qualify for this measure, the installed equipment must be a residential gas-fired storage water heater or Instantaneous (tankless) water heater meeting ENERGY STAR criteria.⁸³⁴

Water Heater Type	Water Heater Tank Volume (gallons)	Draw Pattern	Minimum Uniform Energy Factor
Gas Storage	≤ 55	Medium	≥ 0.81
		High	≥ 0.86
	> 55	All	≥ 0.86
Gas Instantaneous	All	All	≥ 0.95

DEFINITION OF BASELINE EQUIPMENT

Time of Sale or New Construction: The baseline equipment is assumed to be a new, gas-fired storage residential water heater meeting minimum Federal efficiency standards as provided below:

Equipment Type	Sub Category	Draw Pattern	Federal Standard – Uniform Energy Factor ⁸³⁵
Residential Gas Storage Water Heaters ≤75,000 Btu/h	≤55 gallon tanks	Very small	UEF = 0.3456 – (0.0020 * Rated Storage Volume in Gallons)
		Low	UEF = 0.5982 – (0.0019 * Rated Storage Volume in Gallons)
		Medium	UEF = 0.6483 – (0.0017 * Rated Storage Volume in Gallons)
		High	UEF = 0.6920 – (0.0013 * Rated Storage Volume in Gallons)
	>55 gallon and ≤100 gallon tanks	Very small	UEF = 0.6470 – (0.0006 * Rated Storage Volume in Gallons)
		Low	UEF = 0.7689 – (0.0005 * Rated Storage Volume in Gallons)
		Medium	UEF = 0.7897 – (0.0004 * Rated Storage Volume in Gallons)
		High	UEF = 0.8072 – (0.0003 * Rated Storage Volume in Gallons)

⁸³⁴ ENERGY STAR Product Specification for Residential Water Heaters, Version 5.0, effective April 18, 2023.

⁸³⁵ DOE Standard 10 CFR 430, Residential-Duty and Commercial Federal Standard are from DOE Standard 10 CFR 431. Minimum Federal standard as of 4/16/2015, confirmed no changes as of 4/28/2024;
https://www.ecfr.gov/cgi-bin/text-idx?SID=80dfa785ea350ebee184bb0ae03e7f0&mc=true&node=se10.3.430_132&rgn=div8

Draw patterns are based on first hour rating (gallons) for storage tanks as shown below:⁸³⁶

Storage Water Heater Draw Pattern	
Draw Pattern	First Hour Rating (gallons)
Very Small	≥ 0 and < 18
Low	≥ 18 and < 51
Medium	≥ 51 and < 75
High	≥ 75

The same draw pattern (very small, low, medium and high draw) should be used for both baseline and efficient units. If using a deemed approach, for storage water heaters with a storage capacity equal to or less than 55 gallons, the Federal energy factor requirement is calculated as $0.6483 - (0.0017 * \text{storage capacity in gallons})$ assuming a Medium draw and $0.8072 - (0.0003 * \text{storage capacity in gallons})$ assuming a High draw for greater than 55 gallon storage water heaters.

Early Replacement: The baseline is the efficiency of the existing gas water heater for the remaining useful life of the unit and the efficiency of a new gas water heater of the same type meeting minimum Federal efficiency standards for the remainder of the measure life.

DEEMED LIFETIME OF EFFICIENT EQUIPMENT

The expected measure life is assumed to be 14.5 years for gas storage water heaters and 20.0 years for gas instantaneous water heaters.⁸³⁷

For early replacement: Remaining life of existing gas storage and instantaneous water heaters is assumed to be 4.8 and 6.7 years, respectively.⁸³⁸

DEEMED MEASURE COST

Time of Sale or New Construction:

The incremental capital cost for this measure is dependent on the type of water heater as listed below.⁸³⁹

Early Replacement: The full installed cost is provided in the table below. The assumed deferred cost (after 4 years) of replacing existing equipment with a new baseline unit is also provided in the table below. This cost should be discounted to present value using the nominal discount rate.

Water Heater Type	Water Heater Tank Volume (gallons)	Draw Pattern	Incremental Cost	Full Install Cost	Deferred Baseline Replacement Cost ⁸⁴⁰
Gas Storage	≤ 55	Medium	\$230	\$1,968	\$645
		High	\$215	\$2,051	\$780
	> 55	All	\$215	\$2,051	\$780
Gas Instantaneous	All	All	\$293	\$1,954	\$937

⁸³⁶ Definitions provided in 10 CFR 430, Subpart B, Appendix E, Section 5.4.1

⁸³⁷ Supporting document for Energy Conservation Program: Energy Conservation Standards for Consumer Water Heaters. 2023-07-21 Consumer Water Heater Life-Cycle Cost (LCC) and Payback Period Results Analysis (NOPR), EERE-2017-BT-STD-0019-0061.

⁸³⁸ Assumed to be one third of effective useful life

⁸³⁹ Supporting document for Energy Conservation Program: Energy Conservation Standards for Consumer Water Heaters. 2023-07-21 Consumer Water Heater Life-Cycle Cost (LCC) and Payback Period Results Analysis (NOPR), EERE-2017-BT-STD-0019-0061.

⁸⁴⁰ The implied baseline cost from the incremental and full cost is calculated and then inflated applying inflation rate of 1.91% for 4 years.

LOADSHAPE

N/A

COINCIDENCE FACTOR

N/A

Algorithm

CALCULATION OF SAVINGS

ELECTRIC ENERGY SAVINGS

N/A

SUMMER COINCIDENT PEAK DEMAND SAVINGS

N/A

FOSSIL FUEL SAVINGS

Time of Sale or New Construction:

$$\Delta\text{Therms} = (1/ \text{UEF}_{\text{BASE}} - 1/\text{UEF}_{\text{EFFICIENT}}) * (\text{GPD} * \text{Household} * 365.25 * \gamma_{\text{Water}} * (T_{\text{OUT}} - T_{\text{IN}}) * 1.0) / 100,000$$

Early replacement:⁸⁴¹

ΔTherms for remaining life of existing unit (1st 3.7 years for gas storage unit and 1st 6.7 years for gas tankless unit):

$$= (1/ \text{UEF}_{\text{EXISTING}} - 1/\text{UEF}_{\text{EFFICIENT}}) * (\text{GPD} * \text{Household} * 365.25 * \gamma_{\text{Water}} * (T_{\text{OUT}} - T_{\text{IN}}) * 1.0) / 100,000$$

ΔTherms for remaining measure life (next 7.3 years for gas storage unit and next 13.3 years for gas tankless unit):

$$= (1/ \text{UEF}_{\text{BASE}} - 1/\text{UEF}_{\text{EFFICIENT}}) * (\text{GPD} * \text{Household} * 365.25 * \gamma_{\text{Water}} * (T_{\text{OUT}} - T_{\text{IN}}) * 1.0) / 100,000$$

Where:

UEF_Baseline = Uniform Energy Factor rating of standard storage water heater according to federal standards⁸⁴² provided in table in baseline section and using the same draw pattern as the efficient equipment. For a deemed approach:

= For gas storage water heaters ≤55 gallons: $0.6483 - (0.0017 * \text{storage capacity in gallons})$

= For gas storage water heaters >55 gallons: $0.8072 - (0.0003 * \text{storage capacity in gallons})$

= If tank size is unknown, assume 0.563 for a gas storage water heater with a 50-gallon storage capacity

UEF_Efficient = Uniform Energy Factor Rating for efficient equipment

= Actual. If unknown⁸⁴³ assume:

⁸⁴¹ The two equations are provided to show how savings are determined during the initial phase of the measure (existing to efficient) and the remaining phase (new baseline to efficient). In practice, the screening tools used may either require a First Year savings (using the first equation) and then a “number of years to adjustment” and “savings adjustment” input which would be the (new base to efficient savings)/(existing to efficient savings).

⁸⁴² Minimum Federal standard as of 4/16/2015, Confirmed no changes as of 4/28/2023.

⁸⁴³ ENERGY STAR Product Specification for Residential Water Heaters, Version 5.0, effective April 23, 2023.

Unit Type	Unit Capacity	Draw Pattern	Uniform Energy Factor
Gas Storage	≤ 55 gallons	Medium	0.81
		High	0.86
	> 55 gallons	All	0.86
Gas Tankless	All	All	0.95

- UEF_Existing = Uniform Energy Factor rating for existing equipment
 = Use actual UEF rating where it is possible to measure or reasonably estimate.
 = if unknown assume 0.52⁸⁴⁴
- GPD = Gallons Per Day of hot water use per person
 = 45.5 gallons hot water per day per household/2.59 people per household.⁸⁴⁵
 = 17.6
- Household = Average number of people per household

Household Unit Type	Household ⁸⁴⁶		
	IQ Participants	Non-IQ Participants	All Participants
Single-Family - Deemed	2.76	2.62	2.67
Multifamily - Deemed	2.3	2.09	2.18
Household type unknown			2.52 ⁸⁴⁷
Custom	Actual Occupancy or Number of Bedrooms ⁸⁴⁸		

Use Multifamily if: Building meets utility’s definition for multifamily

- 365.25 = Days per year, on average
- γ_{Water} = Specific Weight of water
 = 8.33 pounds per gallon
- T_{OUT} = Tank temperature
 = 125°F
- T_{IN} = Incoming water temperature from well or municipal system
 = 50.7°F⁸⁴⁹
- 1.0 = Heat Capacity of water (1 Btu/lb*°F)

⁸⁴⁴ Based on DCEO Efficient Living Program Data for a sample size of 157 gas water heaters.

⁸⁴⁵ Deoreo, B., and P. Mayer. Residential End Uses of Water Study Update. Forthcoming. ©2015 Water Research Foundation. Reprinted With Permission.

⁸⁴⁶ Assumptions are taken from the draft unadjusted 2024 Baseline Study evaluation data provided in 07/2024 by GDS Associates.

⁸⁴⁷ Unknown is based on statewide weighted average of 69% single family and 31% multifamily, based on IL data from 2009 RECS Table HC2.9 Structural and Geographic Characteristics of Homes in Midwest Region, Divisions and States, 2009.

⁸⁴⁸ Bedrooms are suitable proxies for household occupancy, and may be preferable to actual occupancy due to turnover rates in residency and non-adult population impacts.

⁸⁴⁹ Table 4 in Chen, et. al., “Calculating Average Hot Water Mixes of Residential Plumbing Fixtures”, June 2020, reports a value of 50.7°F for inlet water temperature for U.S. Census Division 3.

For example, a 40 gallon condensing gas storage water heater, with a uniform energy factor of 0.86 in a single family IQ house:

$$\begin{aligned}\Delta\text{Therms} &= (1/0.58 - 1/0.86) * (17.6 * 2.76 * 365.25 * 8.33 * (125 - 50.7) * 1) / 100,000 \\ &= 61.6 \text{ therms}\end{aligned}$$

WATER IMPACT DESCRIPTIONS AND CALCULATION

N/A

DEEMED O&M COST ADJUSTMENT CALCULATION

N/A

MEASURE CODE: RS-HWE-GWHT-V12-250101

REVIEW DEADLINE: 1/1/2027

5.4.3 Heat Pump Water Heaters

DESCRIPTION

A heat pump water heater provides domestic water heating by moving heat between indoor air (conditioned or unconditioned) and a storage water tank.

This measure characterizes:

- a) New Construction:
 - The installation of a domestic heat pump water heater meeting ENERGY STAR efficiency standards in a new home.
 - Note that the baseline in this case should be determined via EM&V and the algorithms are provided to allow savings to be calculated from any baseline condition.
- b) Time of Sale:
 - The installation of a domestic heat pump water heater in place of a standard electric or fossil fuel-fired water heater in a home.
 - Note that the baseline in this case is an equivalent replacement system to that which exists currently in the home. Where unknown, the baseline can be assumed to be a 50 gallon electric storage water heater with medium draw pattern.
- c) Early Replacement
 - The early removal of a functioning fossil-fuel fired water heater from service, prior to its natural end of life, and replacement with a new domestic heat pump water heater.
 - Note that the baseline in this case is the existing equipment being replaced. Savings are calculated between the existing unit and efficient unit consumption during the remaining life of the existing unit, and between a new equivalent replacement system to that which exists currently in the home and efficient unit consumption for the remainder of the measure life.

Savings are presented dependent on the heating system installed in the home, presence of cooling, and presence of dehumidification due to the impact of the heat pump water heater on the heating cooling and dehumidification loads.

This measure was developed to be applicable to the following program types: TOS, NC, ER. If applied to other program types, the measure savings should be verified.

DEFINITION OF EFFICIENT EQUIPMENT

To qualify for this measure the installed equipment must be an ENERGY STAR Heat Pump domestic water heater.

DEFINITION OF BASELINE EQUIPMENT

The baseline condition is a new water heater meeting federal minimum efficiency standards, dependent on the storage volume (in gallons) of the water heater.

Equipment Type	Sub Category	Draw Pattern	Federal Standard – Uniform Energy Factor ⁸⁵⁰
Residential Electric Storage Water Heaters ≤ 75,000 Btu/h	≤55 gallon tanks	Very small	UEF = 0.8808 – (0.0008 * Rated Storage Volume in Gallons)
		Low	UEF = 0.9254 – (0.0003 * Rated Storage Volume in Gallons)
		Medium	UEF = 0.9307 – (0.0002 * Rated Storage Volume in Gallons)
		High	UEF = 0.9349 – (0.0001 * Rated Storage Volume in Gallons)
	>55 gallon and ≤120 gallon tanks ⁸⁵¹	Very small	UEF = 1.9236 – (0.0011 * Rated Storage Volume in Gallons)
		Low	UEF = 2.0440 – (0.0011 * Rated Storage Volume in Gallons)

⁸⁵⁰ All Residential sized Federal Standards are from DOE Standard 10 CFR 430, Residential-Duty and Commercial Federal Standard are from DOE Standard 10 CFR 431.

⁸⁵¹ It is assumed that tanks <75,000Btu/h and >55 gallons will not be eligible measures due to the high baseline.

Equipment Type	Sub Category	Draw Pattern	Federal Standard – Uniform Energy Factor ⁸⁵⁰
		Medium	UEF = 2.1171 – (0.0011 * Rated Storage Volume in Gallons)
		High	UEF = 2.2418 – (0.0011 * Rated Storage Volume in Gallons)
Residential Electric Instantaneous Water Heaters	≤12kW and ≤2 gal	All other	UEF = 0.91
		High	UEF = 0.92
Residential Gas Storage Water Heaters ≤75,000 Btu/h	≤55 gallon tanks	Very small	UEF = 0.3456 – (0.0020 * Rated Storage Volume in Gallons)
		Low	UEF = 0.5982 – (0.0019 * Rated Storage Volume in Gallons)
		Medium	UEF = 0.6483 – (0.0017 * Rated Storage Volume in Gallons)
		High	UEF = 0.6920 – (0.0013 * Rated Storage Volume in Gallons)
	>55 gallon and ≤100 gallon tanks	Very small	UEF = 0.6470 – (0.0006 * Rated Storage Volume in Gallons)
		Low	UEF = 0.7689 – (0.0005 * Rated Storage Volume in Gallons)
		Medium	UEF = 0.7897 – (0.0004 * Rated Storage Volume in Gallons)
		High	UEF = 0.8072 – (0.0003 * Rated Storage Volume in Gallons)
Residential Oil Storage Water Heater	≤50 gallon tanks	Very small	UEF = 0.2509 – (0.0012 * Rated Storage Volume in Gallons)
		Low	UEF = 0.5330 – (0.0016 * Rated Storage Volume in Gallons)
		Medium	UEF = 0.6087 – (0.0016 * Rated Storage Volume in Gallons)
		High	UEF = 0.6815 – (0.0014 * Rated Storage Volume in Gallons)

The same draw pattern (very small, low, medium and high draw) should be used for both baseline and efficient units. If using a deemed approach, for units ≤55 gallons – baseline is assumed to be a resistance storage unit with efficiency: 0.9307 – (0.0002 * rated volume in gallons) assuming medium draw.

For units >55 gallons – assume a 50 gallon resistance tank baseline;⁸⁵² i.e., 0.9299 UEF assuming high draw .

If unknown, assume a 50 gallon resistance tank baseline, at medium draw, therefore 0.9207 UEF. ⁸⁵³

DEEMED LIFETIME OF EFFICIENT EQUIPMENT

The expected measure life is assumed to be 15 years.⁸⁵⁴

DEEMED MEASURE COST

For Time of Sale or New Construction the incremental installation cost (including labor) should be used. Defaults are provided below.⁸⁵⁵ Actual efficient costs can also be used although care should be taken as installation costs can vary significantly due to complexities of a particular site.

For retrofit costs, the actual full installation cost should be used (default provided below if unknown).

Capacity	Efficiency Range	Baseline Installed Cost	Efficient Installed Cost	Incremental Installed Cost
≤55 gallons	<2.6 UEF	\$1,032	\$2,062	\$1,030
	≥2.6 UEF	\$1,032	\$2,231	\$1,199
>55 gallons	<2.6 UEF	\$1,319	\$2,432	\$1,113
	≥2.6 UEF	\$1,319	\$3,116	\$1,797

⁸⁵² A 50 gallon volume tank for the baseline is assumed to capture market practice of using larger heat pump water heaters to achieve greater efficiency of the heat pump cycle and preventing the unit from going in electric resistance mode.

⁸⁵³ About 90% of all water heaters are installed in a replace-on-burnout situation and installers strongly prefer like-for-like equipment replacements in these situations, meaning that fuel switching is unlikely in TOS situations. As stated in Opinion Dynamics Ameren Illinois’ Market Effects Pilot – Heat Pump Hot Water Market Characterization Report, March 4, 2021.

⁸⁵⁴ As recommended in Navigant ‘ComEd Effective Useful Life Research Report’, May 2018.

⁸⁵⁵ Costs for <2.6 UEF are based upon averages from the NEEP Phase 3 Incremental Cost Study. The assumption for higher efficiency tanks is based upon averaged from NEEP Phase 4 Incremental Cost Study. See ‘HPWH Cost Estimation.xls’ for more information.

LOADSHAPE

Loadshape R18 - Residential Heat Pump Water Heater

COINCIDENCE FACTOR

The summer Peak Coincidence Factor is assumed to be 12%.⁸⁵⁶

Algorithm

CALCULATION OF SAVINGS

ELECTRIC ENERGY AND FOSSIL FUEL SAVINGS

Non fuel switch measures:

$$\Delta kWh = (((1/UEF_{BASE} - 1/UEF_{HPWHEFFICIENT}) * GPD * Household * 365.25 * \gamma_{Water} * (T_{OUT} - T_{IN}) * 1.0) / 3412) + CoolingImpact - ElecHeatImpact + Deh_Reduction$$

CoolingImpact⁸⁵⁷ = Cooling savings from conversion of heat in home to water heat

$$= (((((GPD * Household * 365.25 * \gamma_{Water} * (T_{OUT} - T_{IN}) * 1.0) / 3412) - ((1/UEF_{HPWHEFFICIENT} * GPD * Household * 365.25 * \gamma_{Water} * (T_{OUT} - T_{IN}) * 1.0) / 3412)) * LF * 27\%) / COP_{COOL}) * LM$$

ElecHeatImpact = Electric heating cost from conversion of heat in home to water heat (dependent on heating fuel)

$$= (((((GPD * Household * 365.25 * \gamma_{Water} * (T_{OUT} - T_{IN}) * 1.0) / 3412) - ((1/UEF_{HPWHEFFICIENT} * GPD * Household * 365.25 * \gamma_{Water} * (T_{OUT} - T_{IN}) * 1.0) / 3412)) * LF * 37\%) / COP_{HEAT}) * (1 - \%NaturalGas)$$

Deh_Reduction = Savings resulting from reduced dehumidification (provided in table in variable list below)

$\Delta Therms_{HeatImpact}$ = Fossil heating cost from conversion of heat in home to water heat for homes with Natural Gas heat

$$= - ((((((GPD * Household * 365.25 * \gamma_{Water} * (T_{OUT} - T_{IN}) * 1.0) / 3412) - (GPD * Household * 365.25 * \gamma_{Water} * (T_{OUT} - T_{IN}) * 1.0) / 3412) / UEF_{HPWHEFFICIENT})) * LF * 37\% * 0.03412) / \eta_{Heat}) * \%Fossil$$

Fuel switch measures:

Fuel switch measures must produce positive total lifecycle energy savings (i.e., reduction in Btus at the premises) in order to qualify. This is determined as follows:

$$SiteEnergySavings (MMBTUs) = [FossilWHReplaced] - [ElectricWHAdded] + [HVACImpacts]$$

⁸⁵⁶ Calculated from Figure 8 "Combined six-unit summer weekday average electrical demand" in FEMP study; 'Field Testing of Pre-Production Prototype Residential Heat Pump Water Heaters' as (average kW usage during peak period * hours in peak period) / [(annual kWh savings / FLH) * hours in peak period] = (0.1 kW * 5 hours) / [(2100 kWh (default assumptions) / 2533 hours) * 5 hours] = 0.12

⁸⁵⁷ This algorithm calculates the heat removed from the air by subtracting the HPWH electric consumption from the total water heating energy delivered. This is then adjusted to account for location of the HP unit and the coincidence of the waste heat with cooling requirements, the efficiency of the central cooling and latent cooling demands.

$$\begin{aligned} \text{FossilWHRReplaced} &= \text{Fossil fuel consumption of replaced fossil fuel water heater} \\ &= (1/\text{UEF}_{\text{GASBASE}} * \text{GPD} * \text{Household} * 365.25 * \gamma_{\text{Water}} * (T_{\text{OUT}} - T_{\text{IN}}) * 1.0) / 1,000,000 \end{aligned}$$

$$\begin{aligned} \text{ElectricWHAdded} &= \text{Added electric consumption of heat pump water heater} \\ &= (1/\text{UEF}_{\text{HPWHEFFICIENT}} * \text{GPD} * \text{Household} * 365.25 * \gamma_{\text{Water}} * (T_{\text{OUT}} - T_{\text{IN}}) * 1.0) / 1,000,000 \end{aligned}$$

$$\begin{aligned} \text{HVACImpacts [counted as non-fuel switch savings]} &= \text{Heating and cooling impact of heat pump water heater} \\ &= [\text{CoolingImpact} * 3,412/1,000,000] - [\text{ElecHeatImpact} * 3,412/1,000,000] + \\ &\quad [\text{Deh_reduction} * 3,412/1,000,000] - [\Delta\text{ThermS}_{\text{HeatImpact}} * 1/10] \end{aligned}$$

If SiteEnergySavings calculated above is positive, the measure is eligible.

The appropriate savings claim is dependent on which utilities are supporting the measure as provided in a table below:

Measure supported by:	Electric Utility claims (kWh):	Gas Utility claims (therms):
Electric utility only	SiteEnergySavings * 1,000,000/3,412	N/A
Electric and gas utility (Note utilities may make alternative agreements to how savings are allocated as long as total MMBtu savings remains the same).	%IncentiveElectric * SiteEnergySavings * 1,000,000/3,412	%IncentiveGas * SiteEnergySavings * 10
Gas utility only	N/A	SiteEnergySavings * 10

Note for Early Replacement measures, the efficiency terms of the existing water heater should be used for the remaining useful life of the existing equipment and the efficiency terms for a new baseline unit should be used for the remaining years of the measure. See assumptions below.

Where:

UEF_{BASE} = Uniform Energy Factor (efficiency) of standard water heater according to federal standards provided in table in baseline section and using the same draw pattern as the efficient equipment. For a deemed approach assume electric water heater:

For <=55 gallons: 0.9307 – (0.0002 * rated volume in gallons)

For >55 gallons: Use 0.9299⁸⁵⁸

= If unknown volume, use 0.9207⁸⁵⁹

UEF_{HPWHEFFICIENT} = Uniform Energy Factor (efficiency) of Heat Pump water heater

= Actual

GPD = Gallons Per Day of hot water use per person

⁸⁵⁸ Assuming a 50 gallon tank baseline at High Draw due to the accommodate the higher gallon range. 50 gallon is the most common size for HPWHs.

⁸⁵⁹ Assuming a 50 gallon tank baseline at Medium Draw.

= 45.5 gallons hot water per day per household/2.59 people per household ⁸⁶⁰
 = 17.6

Household = Average number of people per household

Household Unit Type	Household ⁸⁶¹		
	IQ Participants	Non-IQ Participants	All Participants
Single-Family - Deemed	2.76	2.62	2.67
Multifamily - Deemed	2.3	2.09	2.18
Household type unknown			2.52 ⁸⁶²
Custom	Actual Occupancy or Number of Bedrooms ⁸⁶³		

Use Multifamily if: Building meets utility’s definition for multifamily

365.25 = Days per year

γ Water = Specific weight of water
 = 8.33 pounds per gallon

T_{OUT} = Tank temperature
 = 125°F

T_{IN} = Incoming water temperature from well or municiple system
 = 50.7°F ⁸⁶⁴

1.0 = Heat Capacity of water (1 Btu/lb*°F)

3412 = Conversion from Btu to kWh

CoolingImpact⁸⁶⁵ = Cooling savings from conversion of heat in home to water heat

$$= \left(\frac{(((GPD * Household * 365.25 * \gamma_{Water} * (T_{OUT} - T_{IN}) * 1.0) / 3412) - ((1 / U_{EF_{HPWH}} * GPD * Household * 365.25 * \gamma_{Water} * (T_{OUT} - T_{IN}) * 1.0) / 3412)) * LF * 27\%}{COP_{COOL}} \right) * LM$$

Where:

LF = Location Factor
 = 1.0 for HPWH installation in a conditioned space
 = 0.22 for HPWH installation in an unknown location⁸⁶⁶
 = 0.0 for installation in an unconditioned space

⁸⁶⁰ Deoreo, B., and P. Mayer. Residential End Uses of Water Study Update. Forthcoming. ©2015 Water Research Foundation. Reprinted With Permission.

⁸⁶¹ Assumptions are taken from the draft unadjusted 2024 Baseline Study evaluation data provided in 07/2024 by GDS Associates.

⁸⁶² Unknown is based on statewide weighted average of 69% single family and 31% multifamily, based on IL data from 2009 RECS Table HC2.9 Structural and Geographic Characteristics of Homes in Midwest Region, Divisions and States, 2009.

⁸⁶³ Bedrooms are suitable proxies for household occupancy, and may be preferable to actual occupancy due to turnover rates in residency and non-adult population impacts.

⁸⁶⁴ Table 4 in Chen, et. al., “Calculating Average Hot Water Mixes of Residential Plumbing Fixtures”, June 2020, reports a value of 50.7°F for inlet water temperature for U.S. Census Division 3.

⁸⁶⁵ This algorithm calculates the heat removed from the air by subtracting the HPWH electric consumption from the total water heating energy delivered. This is then adjusted to account for location of the HP unit and the coincidence of the waste heat with cooling requirements, the efficiency of the central cooling and latent cooling demands.

⁸⁶⁶ West Hills Energy and Computing (2019) found 78% of HPWHs “are installed in basements that are not intentionally heated.”

- 27% = Portion of heat removed from surrounding air that results in cooling savings⁸⁶⁷
- COP_{COOL} = COP of central air conditioning
= Assume 3.3 if central AC or unknown and 3.4 if heat pump ⁸⁶⁸
- LM = Latent multiplier to account for latent cooling demand
= 1.33 ⁸⁶⁹
- ElecHeatImpact = Heating cost from conversion of heat in home to water heat (dependent on heating fuel)
= (((((GPD * Household * 365.25 * γWater * (T_{OUT} – T_{IN}) * 1.0) / 3412) –
(1/ UEF_{HPWHEFFICIENT}* GPD * Household * 365.25 * γWater * (T_{OUT} – T_{IN}) * 1.0) / 3412)) * LF * 37%) / COP_{HEAT}) * (1 - %FossilHeat)

Where:

- 37% = Portion of heat removed from surrounding air that results in increased heating load⁸⁷⁰
- COP_{HEAT} = COP of electric heating system
= actual. If not available use:⁸⁷¹

System Type	HSPF2 Estimate	COP _{HEAT} (COP Estimate) = (HSPF2/3.412)*0.85
Heat Pump	7.0	1.74
Resistance	N/A	1.00
Unknown electric ⁸⁷²	N/A	1.35

Deh_Reduction = Savings resulting from reduced dehumidification

⁸⁶⁷ REMRate determined percentage (27%) of lighting savings that result in reduced cooling loads (lighting is used as a proxy for hot water heating since load shapes suggest their seasonal usage patterns are similar).

⁸⁶⁸ To reduce complexity of the measure and since this relates to a small waste heat impact, instead of assuming actual existing unit HVAC efficiency and a mid-life adjustment to account for future replacement efficiency, the code minimum baseline should be applied. Starting from federal baseline of SEER 13 central AC unit, converted to 11.1 EER using algorithm (-0.02 * SEER2) + (1.12 * SEER) (from Wassmer, M. (2003). A Component-Based Model for Residential Air Conditioner and Heat Pump Energy Calculations. Masters Thesis, University of Colorado at Boulder), converted to COP = EER/3.412 = 3.3COP. Same calculation starting with federal baseline of SEER 14 heat pump results in COP of 3.4.

⁸⁶⁹ A sensible heat ratio (SHR) of 0.75 corresponds to a latent multiplier of 4/3 or 1.33. SHR of 0.75 for typical split system from page 10 of “Controlling Indoor Humidity Using Variable-Speed Compressors and Blowers” by M. A. Andrade and C. W. Bullard, 1999.

⁸⁷⁰ The operation of a HPWH causes both sensible and latent heat transfer with the surrounding air (and water vapor). Only the sensible heat transfer increases the heating load. The portion of the energy transferred from the surrounding air is based on the average result from REMRate modeling of several different configurations and IL locations of homes (49%). The portion of that which is sensible heat further depends on the typical sensible heat ratio of 0.75 (see previous note) the resulting portion of sensible heat transferred from the surrounding air is: 49% * 0.75 = 37%.

⁸⁷¹ To reduce complexity of the measure and since this relates to a small waste heat impact, instead of assuming actual existing unit HVAC efficiency and a mid-life adjustment to account for future replacement efficiency, the code minimum baseline should be applied. Note efficiency includes duct losses. Defaults provided assume 15% duct loss for heat pumps.

⁸⁷² Calculation assumes 35% Heat Pump and 65% Resistance, which is based upon data from Energy Information Administration, 2009 Residential Energy Consumption Survey, see “HC6.9 Space Heating in Midwest Region.xls”, using average for East North Central Region. Average efficiency of heat pump is based on assumption that 50% are units from before 2006 and 50% from 2006-2014. Program or evaluation data should be used to improve this assumption if available.

= values based on table below⁸⁷³

Dehumidification Status	Deh_Reduction (kWh)
If Dehumidifer is in use	359
If unknown	72

$\Delta T_{\text{ThermSHeatImpact}}$ = Heating cost from conversion of heat in home to water heat for homes with Natural Gas heat ⁸⁷⁴

0.03412 = conversion factor (therms per kWh)

η_{Heat} = Efficiency of heating system

= Assume 68% for gas furnace or unknown, 71% for oil furnace, 84% for gas boiler and 86% for oil boiler. ⁸⁷⁵

%FossilHeat = Factor dependent on heating fuel:

= 100 % for fossil fuel heating

= 0 % for Electric Resistance or Heat Pump

= If unknown⁸⁷⁶, use the following table:

Utility	Location				
	Single Family	Single Family Low Income	Multi Family	Multi Family Low Income	Unknown
Ameren	82%	74%	62%	61%	71%
ComEd	86%	78%	57%	52%	79%
PGL	98.9%	98.5%	96.0%	96.9%	97.7%
NSG	98.3%	99.2%	67.5%	98.8%	96.6%
Nicor	98.3%	99.2%	67.5%	98.8%	96.6%
All DUs⁸⁷⁷					74%

Note: If a measure is supported by a gas and electric utility through a joint program, and it is unknown whether the participant has a gas supply, the electric utility values in the table above should be used. If it is

⁸⁷³ West Hills Energy and Computing (2019) found that 20% of homes had dehumidifiers in use and in interviews with homeowners found the following reductions in dehumidifier usage: 46% reported “1 month or more reduction”, 32% reported “3 months or more reduction”, and 15% reported removal of a dehumidifier. kWh savings assumptions are based on an average of: Federal Standard, ENERGY STAR, and ENERGY STAR Most Efficient annual energy usage. See HPWH_CalculationSheet.xlsx for calculations.

⁸⁷⁴ This is the additional energy consumption required to replace the heat removed from the home during the heating season by the heat pump water heater. kWh_heating (electric resistance) is that additional heating energy for a home with electric resistance heat (COP 1.0). This formula converts the additional heating kWh for an electric resistance home to the MMBtu required in a Natural Gas heated home, applying the relative efficiencies.

⁸⁷⁵ To reduce complexity of the measure and since this relates to a small waste heat impact, instead of assuming actual existing unit HVAC efficiency and a mid-life adjustment to account for future replacement efficiency, the code minimum baseline should be applied. Note efficiency includes duct losses. Defaults provided assume 15% duct loss for heat pumps.

⁸⁷⁶ Based on the average % Natural Gas used for space heating in Unknown residential structure types across all utilities covered by the IL program. Residence types include: SF, SF LI, MF & MF LI. Utilities included: Ameren, ComEd, People’s Gas, Northshore Gas & Nicor. Data provided from 2016 Ameren Illinois Demand Side Management (DSM) Market Potential Study by Applied Energy Group, ComEd’s 2019 Baseline Survey on residential space heating share, and PY2022-2023 Implementation Contractors Data for People’s Gas, Northshore Gas & Nicor .

⁸⁷⁷ For the weighted average calculations, please see the Analysis file. PGL, NSG, Nicor & gas customers were assumed to follow the provided split. ComEd total customers, minus overlap with PGL,NSG & Nicor, therefore gas only homes. Ameren is total customers minus Nicor.

known that the participant has a gas supply, the values from the gas utility above should be applied.

For example, a 2.0 UEF heat pump water heater, in a conditioned space in a single family IQ home with gas furnace space heat (68% system efficiency) and central air conditioning (SEER 10.5) in in Belleville and dehumidifier usage is unknown:

$$\begin{aligned} \Delta kWh &= [(1 / 0.9207 - 1 / 2.0) * 17.6 * 2.76 * 365.25 * 8.33 * (125 - 50.7) * 1.0] / 3412 + 162.4 - 0 + 72 \\ &= 2121 \text{ kWh} \end{aligned}$$

$$\begin{aligned} \Delta \text{Therms} &= -((((17.6 * 2.76 * 365.25 * 8.33 * (125 - 50.7) * 1.0) / 3412) - (17.6 * 2.56 * 365.25 * 8.33 * \\ &\quad (125 - 50.7) * 1.0 / 3412 / 2.0)) * 1 * 0.37 * 0.03412) / 0.68) * 1 \\ &= - 32.0 \text{ therms} \end{aligned}$$

Fuel Switch example, a 2.0 UEF heat pump water heater, in a conditioned space in a single family IQ home with gas furnace space heat (68% system efficiency) and central air conditioning (SEER 10.5) in in Belleville and dehumidifier usage is unknown, in place of a baseline 0.64UEF gas water heater:

$$\text{SiteEnergySavings (MMBTUs)} = [\text{FossilWHReplaced}] - [\text{ElectricWHAdded}] + [\text{HVACImpacts}]$$

$$\begin{aligned} \text{FossilWHReplaced} &= (1/\text{UEF}_{\text{GASBASE}} * \text{GPD} * \text{Household} * 365.25 * \gamma_{\text{Water}} * (T_{\text{OUT}} - T_{\text{IN}}) * 1.0) / 1,000,000 \\ &= (1/0.64 * 17.6 * 2.76 * 365.25 * 8.33 * (125 - 50.7) * 1.0) / 1,000,000 \\ &= 17.2 \text{ MMBtu} \end{aligned}$$

$$\begin{aligned} \text{ElectricWHAdded} &= (1/ \text{UEF}_{\text{HPWHEFFICIENT}} * \text{GPD} * \text{Household} * 365.25 * \gamma_{\text{Water}} * (T_{\text{OUT}} - T_{\text{IN}}) * 1.0) \\ &\quad / 1,000,000 \\ &= (1/2.0 * 17.6 * 2.76 * 365.25 * 8.33 * (125 - 50.7) * 1.0) / 1,000,000 \\ &= 5.5 \text{ MMBtu} \end{aligned}$$

$$\begin{aligned} \text{HVACImpacts} &= [\text{CoolingImpact} * 3,412 / 1,000,000] - [\text{ElecHeatImpact} * 3,412 / 1,000,000] + \\ &\quad [\text{Deh_reduction} * 3,412 / 1,000,000] - [\Delta \text{Therms}_{\text{HeatImpact}} * 1 / 10] \\ &= (188.9 * 3412 / 1000000) - (0 * 3412 / 1000000) + (72 * 3412 / 1000000) - (27.7 * 1 / 10) \\ &= -1.88 \text{ MMBtu} \end{aligned}$$

$$\begin{aligned} \text{SiteEnergySavings (MMBTUs)} &= 17.2 - 5.5 + (-1.88) \\ &= 9.82 \text{ MMBtu} \end{aligned}$$

$$\begin{aligned} \text{If supported by an electric utility: } \Delta kWh &= \Delta \text{SiteEnergySavings} * 1,000,000 / 3,412 \\ &= 9.82 * 1,000,000 / 3,412 \\ &= 2,878 \text{ kWh} \end{aligned}$$

SUMMER COINCIDENT PEAK DEMAND SAVINGS

$$\Delta kW = \Delta kWh / \text{Hours} * CF$$

Where:

ΔkWh	= Electric savings (or increase) of measure = For non-fuel switch measures, use ΔkWh as provided in Electric Energy Savings section above, for fuel-switch measures use the ΔkWh as provided in the Cost Effectiveness Screening and Load Reduction Forecasting when Fuel Switching section below
Hours	= Full load hours of water heater = 2533 ⁸⁷⁸
CF	= Summer Peak Coincidence Factor for measure = 0.12 ⁸⁷⁹

For example, a 2.0 UEF heat pump water heater, in a conditioned space in a single family IQ home with gas space heat and central air conditioning in Belleville and dehumidifier usage is unknown:

$$\begin{aligned} kW &= 2121 / 2533 * 0.12 \\ &= 0.100kW \end{aligned}$$

FOSSIL FUEL SAVINGS

Calculation provided together with Electric Energy Savings above.

WATER IMPACT DESCRIPTIONS AND CALCULATION

N/A

DEEMED O&M COST ADJUSTMENT CALCULATION

N/A

COST EFFECTIVENESS SCREENING AND LOAD REDUCTION FORECASTING WHEN FUEL SWITCHING

This measure can involve fuel switching from fossil fuel to electric.

For the purposes of forecasting load reductions due to fuel switch projects per Section 16-111.5B, changes in site energy use at the customer’s meter (using ΔkWh algorithm below), customer switching estimates, NTG, and any other adjustment factors deemed appropriate, should be used.

The inputs to cost effectiveness screening should reflect the actual impacts on the electric and fuel consumption at the customer meter and, for fuel switching measures, should therefore reflect the decrease in one fuel and increase in another, as opposed to the single savings value calculated in the “Electric and Fossil Fuel Energy Savings” section above. Therefore in addition to the calculation of savings claimed, the following values should be used to assess the cost effectiveness of the measure.

$$\begin{aligned} \Delta Therms &= [\text{Gas Water Heating Consumption Replaced}] - [\Delta Therms_{\text{HeatImpact}}] \\ &= [(1/UEF_{\text{GASBASE}} * GPD * Household * 365.25 * \gamma_{\text{Water}} * (T_{\text{OUT}} - T_{\text{IN}}) * 1.0) / 100,000] - \\ & \quad [(((GPD * Household * 365.25 * \gamma_{\text{Water}} * (T_{\text{OUT}} - T_{\text{IN}}) * 1.0) / 3412) - (GPD * Household * 365.25 * \gamma_{\text{Water}} * (T_{\text{OUT}} - T_{\text{IN}}) * 1.0) / 3412) / UEF_{\text{HPWHEFFICIENT}}) * LF * 37\% * 0.03412) / \eta_{\text{Heat}}] * \%_{\text{FossilHeat}} \end{aligned}$$

⁸⁷⁸ Full load hours assumption based on Efficiency Vermont analysis of Itron eShapes.

⁸⁷⁹ Calculated from Figure 8 "Combined six-unit summer weekday average electrical demand" in FEMP study; 'Field Testing of Pre-Production Prototype Residential Heat Pump Water Heaters' as (average kW usage during peak period * hours in peak period) / [(annual kWh savings / FLH) * hours in peak period] = (0.1 kW * 5 hours) / [(2100 kWh / 2533 hours) * 5 hours] = 0.12

$$\Delta kWh = - [Electric\ Water\ Heating\ Consumption\ Added] + [Cooling\ Impact] - [Elec\ Heat\ Impact] + [Deh\ Reduction]$$

$$= - (1 / U_{EF,HPWHEFFICIENT} * GPD * Household * 365.25 * \gamma_{Water} * (T_{OUT} - T_{IN}) * 1.0) / 3,412 + [((((GPD * Household * 365.25 * \gamma_{Water} * (T_{OUT} - T_{IN}) * 1.0) / 3412) - ((1 / U_{EF,HPWHEFFICIENT} * GPD * Household * 365.25 * \gamma_{Water} * (T_{OUT} - T_{IN}) * 1.0) / 3412)) * LF * 27\% / COP_{COOL}) * LM] - [((((GPD * Household * 365.25 * \gamma_{Water} * (T_{OUT} - T_{IN}) * 1.0) / 3412) - ((1 / U_{EF,HPWHEFFICIENT} * GPD * Household * 365.25 * \gamma_{Water} * (T_{OUT} - T_{IN}) * 1.0) / 3412)) * LF * 37\% / COP_{HEAT}) * (1 - \%FossilHeat)] + [Deh\ Reduction]$$

MEASURE CODE: RS-HWE-HPWH-V14-250101

REVIEW DEADLINE: 1/1/2027

5.4.4 Low Flow Faucet Aerators

DESCRIPTION

This measure relates to the installation of a low flow faucet aerator in a household kitchen or bath faucet fixture.

This measure may be used for units provided through Efficiency Kits however the in-service rate for such measures should be derived through evaluation results specifically for this implementation methodology.

This measure was developed to be applicable to the following program types: TOS, NC, RF, DI, KITS.

If applied to other program types, the measure savings should be verified.

DEFINITION OF EFFICIENT EQUIPMENT

To qualify for this measure the installed equipment must be a low flow faucet aerator, for bathrooms rated at 1.5 gallons per minute (GPM) or less, or for kitchens rated at 2.2 GPM or less. Savings are calculated on an average savings per faucet fixture basis.

DEFINITION OF BASELINE EQUIPMENT

The baseline condition is assumed to be a standard bathroom faucet aerator rated at 2.2 GPM or greater, or a standard kitchen faucet aerator rated at 2.2 GPM or greater.

Average measured flow rates are used in the algorithm and are lower, reflecting the penetration of previously installed low flow fixtures (and therefore the freerider rate for this measure should be 0), use of the faucet at less than full flow, debris buildup, and lower water system pressure than fixtures are rated at.

DEEMED LIFETIME OF EFFICIENT EQUIPMENT

The expected measure life is assumed to be 10 years.⁸⁸⁰

DEEMED MEASURE COST

For time of sale or new construction the incremental cost for this measure is \$3,⁸⁸¹ or program actual.

For faucet aerators provided through Direct Install or within Efficiency Kits, the actual program delivery costs (including labor if applicable) should be utilized. If unknown, assume \$8 for Direct Install⁸⁸² and \$3 for Efficiency Kits.

LOADSHAPE

Loadshape R03 - Residential Electric DHW

COINCIDENCE FACTOR

The coincidence factor for this measure is assumed to be 2.2%.⁸⁸³

⁸⁸⁰ As recommended in Navigant 'ComEd Effective Useful Life Research Report', May 2018.

⁸⁸¹ 2011, Market research average of \$3.

⁸⁸² Includes assess and install labor time of \$5 (20min @ \$15/hr)

⁸⁸³ Calculated as follows: Assume 18% aerator use takes place during peak hours (based on: Oreo et al, "The end uses of hot water in single family homes from flow trace analysis", 2001.) There are 65 days in the summer peak period, so the percentage of total annual aerator use in peak period is $0.18 * 65 / 365 = 3.21\%$. The number of hours of recovery during peak periods is therefore assumed to be $3.21\% * 180 = 5.8$ hours of recovery during peak period where 180 equals the average annual electric DHW recovery hours for faucet use including SF and MF homes. There are 260 hours in the peak period so the probability you will see savings during the peak period is $5.8 / 260 = 0.022$

Algorithm

CALCULATION OF SAVINGS

ELECTRIC ENERGY SAVINGS

Note these savings are *per* faucet retrofitted⁸⁸⁴ (unless faucet type is unknown, then it is per household).

$$\Delta kWh = \%ElectricDHW * ((GPM_base * L_base - GPM_low * L_low) * Household * 365.25 * DF / FPH) * EPG_electric * ISR$$

Where:

- %ElectricDHW = Percentage of DHW savings assumed to be electric
- = 100 % for Electric
- = 0 % for Fossil Fuel
- = If unknown⁸⁸⁵, use the following table:

Utility	Location				
	Single Family	Single Family Low Income	Multi Family	Multi Family Low Income	Unknown
Ameren ⁸⁸⁶	24%	25%	40%	43%	28%
ComEd ⁸⁸⁷	8%		11%		9%
People’s Gas ⁸⁸⁸	2.0%	2.0%	1.7%	2.1%	2.0%
Northshore Gas ⁸⁸⁹	1.3%	1.8%	10.0%	2.4%	2.3%
Nicor Gas ⁸⁹⁰	1.3%	1.8%	10.0%	2.4%	2.3%
All DUs⁸⁹¹					25%

Note: If a measure is supported by a gas and electric utility through a joint program, and it is unknown whether the participant has a gas supply, the electric utility values in the table above should be used. If it is known that the participant has a gas supply, the values from the gas utility above should be applied.

- GPM_base = Average flow rate, in gallons per minute, of the baseline faucet “as-used.”
- = If unknown assume values in table below, or custom based on metering studies,⁸⁹² or if measured during DI:

⁸⁸⁴ This algorithm calculates the amount of energy saved per aerator by determining the fraction of water consumption savings for the upgraded fixture.

⁸⁸⁵ Based on the average % electricity used for water heating in Unknown residential structure types across all utilities covered by the IL program. Residence types include: SF, SF LI, MF & MF LI. Utilities included: Ameren, ComEd, People’s Gas, Northshore Gas & Nicor. Please see subsequent table and citations for specific sources.

⁸⁸⁶ Provided by AEG from the 2020 Market Potential Study completed for AIC, as well as AIC Income Qualified Initiative: 2021 Participant Survey Results Memo (February 1, 2022) p. 17.

⁸⁸⁷ Commonwealth Edison Residential Baseline Study (2020). p.4.4 & 4.19; Section 4-7 Water Heating. Prepared by Itron.

⁸⁸⁸ Implementation Contractors data from Peoples Gas and North Shore Gas for PY2022-2023.

⁸⁸⁹ Ibid.

⁸⁹⁰ Comparable service area & customers to NSG, therefore using their survey data.

⁸⁹¹ For the weighted average calculations, please see the Analysis file. PGL, NSG, Nicor & gas customers were assumed to follow the provided split. ComEd total customers, minus overlap with PGL,NSG & Nicor, therefore electric only homes. Ameren is total customers minus Nicor.

⁸⁹² Measurement should be based on actual average flow consumed over a period of time rather than a onetime spot measurement for maximum flow. Studies have shown maximum flow rates do not correspond well to average flow rate due to occupant behavior which does not always use maximum flow.

= Measured full throttle flow * 0.83 throttling factor⁸⁹³

Note, if GPM_base is based upon the deemed assumptions below, since these include participants that had existing low flow fixtures, the freerider rate for this measure should be 0.

Faucet Type	GPM ⁸⁹⁴
Kitchen	1.63
Bathroom	1.53
If faucet location unknown	1.58

GPM_low = Average flow rate, in gallons per minute, of the low-flow faucet aerator “as-used”
 = 0.94,⁸⁹⁵ or custom based on metering studies,⁸⁹⁶ or if measured during DI:
 = Rated full throttle flow * 0.95 throttling factor⁸⁹⁷

L_base = Average baseline daily length faucet use per capita for faucet of interest in minutes
 = if available custom based on metering studies, if not use:

Faucet Type	L_base (min/person/day)
Kitchen	4.5 ⁸⁹⁸
Bathroom	1.6 ⁸⁹⁹
If faucet location unknown (total for household): Single-Family except mobile homes	9.0 ⁹⁰⁰
If location unknown (total for household): Multifamily and mobile homes	6.9 ⁹⁰¹
If faucet location and building type unknown (total for household)	8.3 ⁹⁰²

⁸⁹³ 2008, Schultdt, Marc, and Debra Tachibana. Energy related Water Fixture Measurements: Securing the Baseline for Northwest Single Family Homes. 2008 ACEEE Summer Study on Energy Efficiency in Buildings. Page 1-265. www.seattle.gov/light/Conserve/Reports/paper_10.pdf

⁸⁹⁴ Based on flow meter bag testing conducted from June 2013 to January 2014 by Franklin Energy. Over 300 residential sites in the Chicago area were tested.

⁸⁹⁵ Average retrofit flow rate for kitchen and bathroom faucet aerators from sources 2, 4, 5, and 7 (see source table at end of characterization). This accounts for all throttling and differences from rated flow rates. Assumes all kitchen aerators at 2.2 gpm or less and all bathroom aerators at 1.5 gpm or less. The most comprehensive available studies did not disaggregate kitchen use from bathroom use, but instead looked at total flow and length of use for all faucets. This makes it difficult to reliably separate kitchen water use from bathroom water use. It is possible that programs installing low flow aerators lower than the 2.2 gpm for kitchens and 1.5 gpm for bathrooms will see a lower overall average retrofit flow rate.

⁸⁹⁶ Measurement should be based on actual average flow consumed over a period of time rather than a onetime spot measurement for maximum flow. Studies have shown maximum flow rates do not correspond well to average flow rate due to occupant behavior which does not always use maximum flow.

⁸⁹⁷ 2008, Schultdt, Marc, and Debra Tachibana. Energy related Water Fixture Measurements: Securing the Baseline for Northwest Single Family Homes. 2008 ACEEE Summer Study on Energy Efficiency in Buildings. Page 1-265.

⁸⁹⁸ Cadmus and Opinion Dynamics Showerhead and Faucet Aerator Meter Study Memorandum dated June 2013, directed to Michigan Evaluation Working Group. This study of 135 single and Multifamily homes in Michigan metered energy parameters for efficient showerhead and faucet aerators.

⁸⁹⁹ Ibid.

⁹⁰⁰ One kitchen faucet plus 2.83 bathroom faucets. Based on findings from a 2009 ComEd residential survey of 140 sites, provided by Cadmus.

⁹⁰¹ One kitchen faucet plus 1.5 bathroom faucets. Based on findings from a 2009 ComEd residential survey of 140 sites, provided by Cadmus.

⁹⁰² Unknown is based on statewide weighted average of 69% single family and 31% multifamily, based on IL data from 2009 RECS Table HC2.9 Structural and Geographic Characteristics of Homes in Midwest Region, Divisions and States, 2009.

L_{low} = Average retrofit daily length faucet use per capita for faucet of interest in minutes
 = if available custom based on metering studies, if not use:

Faucet Type	L _{low} (min/person/day)
Kitchen	4.5 ⁹⁰³
Bathroom	1.6 ⁹⁰⁴
If faucet location unknown (total for household): Single-Family except mobile homes	9.0 ⁹⁰⁵
If faucet location unknown (total for household): Multifamily	6.9 ⁹⁰⁶
If faucet location and building type unknown (total for household)	8.3 ⁹⁰⁷

Household = Average number of people per household

Household Unit Type	Household ⁹⁰⁸		
	IQ Participants	Non-IQ Participants	All Participants
Single-Family - Deemed	2.76	2.62	2.67
Multifamily - Deemed	2.3	2.09	2.18
Household type unknown			2.52 ⁹⁰⁹
Custom	Actual Occupancy or Number of Bedrooms ⁹¹⁰		

Use Multifamily if: Building meets utility’s definition for multifamily

365.25 = Days in a year, on average.

DF = Drain Factor

Faucet Type	Drain Factor ⁹¹¹
Kitchen	75%
Bath	90%
Unknown	79.5%

⁹⁰³ Cadmus and Opinion Dynamics Showerhead and Faucet Aerator Meter Study Memorandum dated June 2013, directed to Michigan Evaluation Working Group.

⁹⁰⁴ Ibid.

⁹⁰⁵ One kitchen faucet plus 2.83 bathroom faucets. Based on findings from a 2009 ComEd residential survey of 140 sites, provided by Cadmus.

⁹⁰⁶ One kitchen faucet plus 1.5 bathroom faucets. Based on findings from a 2009 ComEd residential survey of 140 sites, provided by Cadmus.

⁹⁰⁷ Unknown is based on statewide weighted average of 69% single family and 31% multifamily, based on IL data from 2009 RECS Table HC2.9 Structural and Geographic Characteristics of Homes in Midwest Region, Divisions and States, 2009.

⁹⁰⁸ Assumptions are taken from the draft unadjusted 2024 Baseline Study evaluation data provided in 07/2024 by GDS Associates.

⁹⁰⁹ Unknown is based on statewide weighted average of 69% single family and 31% multifamily, based on IL data from 2009 RECS Table HC2.9 Structural and Geographic Characteristics of Homes in Midwest Region, Divisions and States, 2009.

⁹¹⁰ Bedrooms are suitable proxies for household occupancy, and may be preferable to actual occupancy due to turnover rates in residency and non-adult population impacts.

⁹¹¹ Because faucet usages are at times dictated by volume, only usage of the sort that would go straight down the drain will provide savings. VEIC is unaware of any metering study that has determined this specific factor and so through consensus with the Illinois Technical Advisory Group have deemed these values to be 75% for the kitchen and 90% for the bathroom. If the aerator location is unknown an average of 79.5% should be used which is based on the assumption that 70% of household water runs through the kitchen faucet and 30% through the bathroom $(0.7*0.75)+(0.3*0.9)=0.795$.

FPH = Faucets Per Household

Faucet Type	FPH
Kitchen Faucets Per Home (KFPH)	1
Bathroom Faucets Per Home (BFPH): Single-Family except mobile homes	2.83 ⁹¹²
Bathroom Faucets Per Home (BFPH): Multifamily and mobile homes	1.5 ⁹¹³
If faucet location unknown (total for household): Single-Family except mobile homes	3.83
If faucet location unknown (total for household): Multifamily and mobile homes	2.5
If faucet location and building type unknown (total for household)	3.42 ⁹¹⁴

EPG_{electric} = Energy per gallon of water used by faucet supplied by electric water heater
 = $(8.33 * 1.0 * (\text{WaterTemp} - \text{SupplyTemp})) / (\text{RE}_{\text{electric}} * 3,412)$
 = $(8.33 * 1.0 * (86 - 50.7)) / (0.98 * 3,412)$
 = 0.0879 kWh/gal (Bath), 0.1054 kWh/gal (Kitchen), 0.1004 kWh/gal (Unknown)

8.33 = Specific weight of water (lbs/gallon)

1.0 = Heat Capacity of water (btu/lb-°F)

WaterTemp = Assumed temperature of mixed water
 = 86°F for Bath, 93°F for Kitchen 91°F for Unknown⁹¹⁵

SupplyTemp = Assumed temperature of water entering house
 = 50.7°F⁹¹⁶

RE_{electric} = Recovery efficiency of electric water heater
 = 98%⁹¹⁷

3412 = Converts Btu to kWh (btu/kWh)

ISR = In service rate of faucet aerators dependant on install method as listed in table below

⁹¹²Based on findings from a 2009 ComEd residential survey of 140 sites, provided by Cadmus.

⁹¹³ Ibid.

⁹¹⁴ Unknown is based on statewide weighted average of 69% single family and 31% multifamily, based on IL data from 2009 RECS Table HC2.9 Structural and Geographic Characteristics of Homes in Midwest Region, Divisions and States, 2009.

⁹¹⁵ Cadmus and Opinion Dynamics Showerhead and Faucet Aerator Meter Study Memorandum dated June 2013, directed to Michigan Evaluation Working Group. If the aerator location is unknown an average of 91% should be used which is based on the assumption that 70% of household water runs through the kitchen faucet and 30% through the bathroom $(0.7*93)+(0.3*86)=91F$.

⁹¹⁶ Table 4 in Chen, et. al., "Calculating Average Hot Water Mixes of Residential Plumbing Fixtures", June 2020, reports a value of 50.7°F for inlet water temperature for U.S. Census Division 3.

⁹¹⁷ Electric water heaters have recovery efficiency of 98%.

Selection	ISR
Direct Install	0.955 ⁹¹⁸
Virtual Assessment followed by Unverified Self-Install	0.77 ^{919,920}
Requested Efficiency Kit	0.60 ⁹²¹
Distributed Efficiency Kit (Income Eligible)	0.46 ⁹²²
Community Distributed Kit	0.45 ⁹²³
Distributed School Efficiency Kit	0.505 ⁹²⁴

For example, a direct installed kitchen low flow faucet aerator in an individual electric DHW IQ SF home:

$$\Delta\text{kWh} = 1.0 * (((1.63 * 4.5 - 0.94 * 4.5) * 2.76 * 365.25 * 0.75) / 1) * 0.1054 * 0.93$$

$$= 230.1 \text{ kWh}$$

For example, a direct installed bath low flow faucet aerator in a shared electric DHW non-IQ home:

$$\Delta\text{kWh} = 1.0 * (((1.53 * 1.6 - 0.94 * 1.6) * 2.09 * 365.25 * 0.90) / 1.5) * 0.0879 * 0.93$$

$$= 35.3 \text{ kWh}$$

For example, a direct installed low flow faucet aerator in unknown faucet in an individual electric DHW IQ SF home:

$$\Delta\text{kWh} = 1.0 * (((1.58 * 9.0 - 0.94 * 9.0) * 2.76 * 365.25 * 0.795) / 3.83) * 0.1004 * 0.93$$

$$= 112.5 \text{ kWh}$$

Secondary kWh Savings for Water Supply and Wastewater Treatment

The following savings should be included in the total savings for this measure but should not be included in TRC tests to avoid double counting the economic benefit of water savings.

$$\Delta\text{kWh}_{\text{water}} = \Delta\text{Water (gallons)} / 1,000,000 * E_{\text{water total}}$$

Where

⁹¹⁸ ComEd Energy Efficiency/ Demand Response Plan: Plan Year 2 (6/1/2009-5/31/2010) Evaluation Report: All Electric Single Family Home Energy Performance Tune-Up Program Table 3-8. Navigant, ComEd-Nicor Gas EPY4/GPY1 Multifamily Home Energy Savings Program Evaluation Report DRAFT 2013-01-28. Average from a 2023 survey of multifamily tenants who participated in a 2023 Direct Install program through Ameren Illinois. The ISR for kitchen and bathroom aerators was found to be 97.7% and 98.3%, respectively. Opinion Dynamics, “2023 AIC Multifamily Initiatives Tenant Survey Findings Memo”, Ameren Illinois, Multifamily Initiatives, April 24, 2024. These sources have been averaged to arrive at an ISR of 0.955.

⁹¹⁹ An equal weighted average of Direct Install and Efficiency Kit ISRs. Guidehouse, *In-Service Rates for CY2020 Single Family Virtual Assessment Measures*, August 20, 2020. Interest and applicability of measures confirmed through virtual assessment. Please note, these ISRs do not apply to retail purchases by end user.

⁹²⁰ An equal weighted average of Direct Install and Efficiency Kit ISRs. Interest and applicability of measures confirmed through virtual assessment. Please note, these ISRs do not apply to retail purchases by end user.

⁹²¹ A weighted ISR was found by weighting Nicor and Ameren efficiency kit program uptake and their previously found ISRs. This analysis can be found in Faucet Aerators and Showerheads Weighted Average ISR IL TRM.xlsx.

⁹²² Average of Guidehouse survey research for Peoples Gas, June 16, 2020 and Research from 2021 Ameren Illinois Income Qualified participant survey, available on IL SAG website: <https://ilsag.s3.amazonaws.com/AIC-Income-Qualified-Initiative-Participant-Survey-Results-Memo-FINAL-2022-02-01.pdf>

⁹²³ Research from 2018 Ameren Illinois Income Qualified participant survey.

⁹²⁴ Results from Home Energy Worksheets completed by student/families in 2020, 2021, and 2022 were nearly the same as values from: Opinion Dynamics and Cadmus. 2018 AIC Residential Program Annual Impact Evaluation Report. April 30, 2019. Results from implementer-administered participant survey. Home Energy Worksheets also establish the fraction of participants who indicate they “will install later” for specific measures. Follow-up research completed by Guidehouse for Nicor Gas in 2022 found that, on average, 51.3% of respondents who initially reported that they hadn’t installed specific kit measures, but “planned to” subsequently had installed the measures. Combining these findings allows for an ISR that accounts for initial and one round of subsequent installations. To maintain a conservative estimate of ISR, the remaining 48.7% are presumed uninstalled. See: EESchoolKitSubsequentInstall_HEW.xlsx for data and calculations.

$$E_{\text{water total}} = \text{IL Total Water Energy Factor (kWh/Million Gallons)}$$

$$= 5,010^{925}$$

For example, a direct installed kitchen low flow aerator in a single family IQ home

$$\Delta \text{Water (gallons)} = (((1.63 * 4.5 - 0.94 * 4.5) * 2.76 * 365.25 * 0.75) / 1) * 0.93$$

$$= 2,183 \text{ gallons}$$

$$\Delta \text{kWh}_{\text{water}} = 2,183 / 1,000,000 * 5,010$$

$$= 10.9 \text{ kWh}$$

SUMMER COINCIDENT PEAK DEMAND SAVINGS

$$\Delta \text{kW} = \Delta \text{kWh} / \text{Hours} * \text{CF}$$

Where:

ΔkWh = calculated value above. Note do not include the secondary savings in this calculation.

Hours = Annual electric DHW recovery hours for faucet use per faucet

$$= ((\text{GPM}_{\text{base}} * L_{\text{base}}) * \text{Household}/\text{FPH} * 365.25 * \text{DF}) * 0.567^{926} / \text{GPH}$$

Building Type	Faucet location	Calculation	Hours per faucet
Single Family IQ	Kitchen	$((1.63 * 4.5) * 2.76 / 1 * 365.25 * 0.75) * 0.567 / 26.1$	120
	Bathroom	$((1.53 * 1.6) * 2.76 / 2.83 * 365.25 * 0.9) * 0.567 / 26.1$	17
	Unknown	$((1.58 * 9.0) * 2.76 / 3.83 * 365.25 * 0.795) * 0.567 / 26.1$	65
Single Family Non-IQ	Kitchen	$((1.63 * 4.5) * 2.62 / 1 * 365.25 * 0.75) * 0.567 / 26.1$	114
	Bathroom	$((1.53 * 1.6) * 2.62 / 2.83 * 365.25 * 0.9) * 0.567 / 26.1$	16
	Unknown	$((1.58 * 9.0) * 2.62 / 3.83 * 365.25 * 0.795) * 0.567 / 26.1$	61
Multifamily IQ	Kitchen	$((1.63 * 4.5) * 2.3 / 1 * 365.25 * 0.75) * 0.567 / 26.1$	100
	Bathroom	$((1.53 * 1.6) * 2.3 / 1.5 * 365.25 * 0.9) * 0.567 / 26.1$	27
	Unknown	$((1.58 * 6.9) * 2.3 / 2.5 * 365.25 * 0.795) * 0.567 / 26.1$	63
Multifamily Non-IQ	Kitchen	$((1.63 * 4.5) * 2.09 / 1 * 365.25 * 0.75) * 0.567 / 26.1$	91
	Bathroom	$((1.53 * 1.6) * 2.09 / 1.5 * 365.25 * 0.9) * 0.567 / 26.1$	24
	Unknown	$((1.58 * 6.9) * 2.09 / 2.5 * 365.25 * 0.795) * 0.567 / 26.1$	57

GPH = Gallons per hour recovery of electric water heater calculated for 69.3°F temp rise (120-50.7), 98% recovery efficiency, and typical 4.5kW electric resistance storage tank.

$$= 26.1$$

CF = Coincidence Factor for electric load reduction

$$= 0.022^{927}$$

⁹²⁵ This factor includes 2571 kWh/MG for water supply based on Illinois energy intensity data from a 2012 ISAWWA study and 2439 kWh/MG for wastewater treatment based on national energy intensity use estimates. For more information please review Elevate Energy’s ‘IL TRM: Energy per Gallon Factor, May 2018 paper’.

⁹²⁶ 56.7% is the proportion of hot 120F water mixed with 50.7F supply water to give 90F mixed faucet water.

⁹²⁷ Calculated as follows: Assume 18% aerator use takes place during peak hours (based on: Oreo et al, “The end uses of hot water in single family homes from flow trace analysis”, 2001.) There are 65 days in the summer peak period, so the percentage of total annual aerator use in peak period is $0.18 * 65 / 365 = 3.21\%$. The number of hours of recovery during peak periods is

For example, a direct installed kitchen low flow faucet aerator in a single family electric DHW IQ home:

$$\begin{aligned} \Delta kW &= 230.1/120 * 0.022 \\ &= 0.042 \text{ kW} \end{aligned}$$

FOSSIL FUEL SAVINGS

$$\Delta \text{Therms} = \% \text{FossilDHW} * ((\text{GPM_base} * \text{L_base} - \text{GPM_low} * \text{L_low}) * \text{Household} * 365.25 * \text{DF} / \text{FPH}) * \text{EPG_gas} * \text{ISR}$$

Where:

- $\% \text{FossilDHW}$ = Percentage of DHW savings assumed to be fossil fuel
- = 100 % for Fossil Fuel
- = 0 % for Electric
- = If unknown⁹²⁸, use the following table:

Utility	Location				
	Single Family	Single Family Low Income	Multi Family	Multi Family Low Income	Unknown
Ameren ⁹²⁹	76%	75%	60%	57%	72%
ComEd ⁹³⁰	92%		89%		91%
People’s Gas ⁹³¹	97.9%	98.0%	98.3%	97.6%	97.8%
Northshore Gas ⁹³²	98.5%	98.2%	90.0%	97.6%	97.6%
Nicor Gas ⁹³³	98.5%	98.2%	90.0%	97.6%	97.6%
All DUs⁹³⁴					75%

Note: If a measure is supported by a gas and electric utility through a joint program, and it is unknown whether the participant has a gas supply, the electric utility values in the table above should be used. If it is known that the participant has a gas supply, the values from the gas utility above should be applied.

EPG_gas = Energy per gallon of Hot water supplied by gas

$$= (8.33 * 1.0 * (\text{WaterTemp} - \text{SupplyTemp})) / (\text{RE_gas} * 100,000)$$

= 0.0038 Therm/gal for SF homes (Bath), 0.0045 Therm/gal for SF homes (Kitchen), 0.0043 Therm/gal for SF homes (Unknown)

therefore assumed to be 3.21% * 180 = 5.8 hours of recovery during peak period where 180 equals the average annual electric DHW recovery hours for faucet use including SF and MF homes. There are 260 hours in the peak period so the probability you will see savings during the peak period is 5.8/260 = 0.022

⁹²⁸ Based on the average % electricity used for water heating in Unknown residential structure types across all utilities covered by the IL program. Residence types include: SF, SF LI, MF & MF LI. Utilities included: Ameren, ComEd, People’s Gas, Northshore Gas & Nicor. Please see subsequent table and citations for specific sources.

⁹²⁹ Provided by AEG from the 2020 Market Potential Study completed for AIC, as well as AIC Income Qualified Initiative: 2021 Participant Survey Results Memo (February 1, 2022) p. 17.

⁹³⁰ Commonwealth Edison Residential Baseline Study (2020). p.4.4 & 4.19; Section 4-7 Water Heating. Prepared by Itron.

⁹³¹ Residential Appliance Saturation Survey of natural gas for space heating and water heating (2021). Note, Multifamily customers have a residential billing rate code and responded on the survey that they live in an apartment or condominium in a building that has either 2-4 or 5+ units.

⁹³² Ibid.

⁹³³ Comparable service area & customers to NSG, therefore using their survey data.

⁹³⁴ For the weighted average calculations, please see the Analysis file. PGL, NSG, Nicor & gas customers were assumed to follow the provided split. ComEd total customers, minus overlap with PGL, NSG & Nicor, therefore gas only homes. Ameren is total customers minus Nicor.

- = 0.0044 Therm/gal for MF homes (Bath), 0.0053 Therm/gal for MF homes (Kitchen), 0.0050 Therm/gal for MF homes (Unknown)
- RE_gas = Recovery efficiency of gas water heater
 - = 78% For individual water heater⁹³⁵
 - = 67% For shared water heater⁹³⁶
- If unknown, use individual water heater value for single family, use shared water heater value for multifamily. Use multifamily if building meets utility’s definition for multifamily.
- 100,000 = Converts Btus to Therms (btu/Therm)
- Other variables as defined above.

For example, a direct-installed kitchen low flow faucet aerator in a fuel DHW single family IQ home:

$$\Delta\text{Therms} = 1.0 * ((1.63 * 4.5 - 0.94 * 4.5) * 2.76 * 365.25 * 0.75) / 1) * 0.0045 * 0.93$$

$$= 9.82 \text{ Therms}$$

For example, a direct installed bath low flow faucet aerator in a fuel DHW multifamily non-IQ home:

$$\Delta\text{Therms} = 1.0 * (((1.53 * 1.6 - 0.94 * 1.6) * 2.09 * 365.25 * 0.90) / 1.5) * 0.0044 * 0.93$$

$$= 1.77 \text{ Therms}$$

For example, a direct installed low flow faucet aerator in unknown faucet in a fuel DHW single family IQ home:

$$\Delta\text{Therms} = 1.0 * (((1.58 * 9.0 - 0.94 * 9.0) * 2.76 * 365.25 * 0.795) / 3.83) * 0.0043 * 0.93$$

$$= 4.82 \text{ Therms}$$

WATER IMPACT DESCRIPTIONS AND CALCULATION

$$\Delta\text{Water (gallons)} = ((\text{GPM}_{\text{base}} * L_{\text{base}} - \text{GPM}_{\text{low}} * L_{\text{low}}) * \text{Household} * 365.25 * \text{DF} / \text{FPH}) * \text{ISR}$$

Variables as defined above

For example, a direct installed kitchen low flow aerator in a single family IQ home

$$\Delta\text{Water (gallons)} = (((1.63 * 4.5 - 0.94 * 4.5) * 2.76 * 365.25 * 0.75) / 1) * 0.93$$

$$= 2,183 \text{ gallons}$$

For example, a direct installed bath low flow faucet aerator in a multifamily non-IQ home:

$$\Delta\text{Water (gallons)} = (((1.53 * 1.6 - 0.94 * 1.6) * 2.09 * 365.25 * 0.90) / 1.5) * 0.93$$

$$= 4,02 \text{ gallons}$$

For example, a direct installed low flow faucet aerator in unknown faucet in a single family IQ home:

$$\Delta\text{Water (gallons)} = (((1.58 * 9.0 - 0.94 * 9.0) * 2.76 * 365.25 * 0.795) / 3.83) * 0.93$$

$$= 1,121 \text{ gallons}$$

⁹³⁵ DOE Final Rule discusses Recovery Efficiency with an average around 0.76 for Gas Fired Storage Water heaters and 0.78 for standard efficiency gas fired tankless water heaters up to 0.95 for the highest efficiency gas fired condensing tankless water heaters. These numbers represent the range of new units however, not the range of existing units in stock. Review of AHRI Directory suggests range of recovery efficiency ratings for new Gas DHW units of 70-87%. Average of existing units is estimated at 78%.

⁹³⁶ Water heating in Multifamily buildings is often provided by a larger central boiler. This suggests that the average recovery efficiency is somewhere between a typical central boiler efficiency of 0.59 and the 0.75 for single family homes. An average efficiency of 0.67 is used for this analysis as a default for Multifamily buildings.

DEEMED O&M COST ADJUSTMENT CALCULATION

N/A

SOURCES

Source ID	Reference
1	2011, DeOreo, William. California Single Family Water Use Efficiency Study. April 20, 2011.
2	2000, Mayer, Peter, William DeOreo, and David Lewis. Seattle Home Water Conservation Study. December 2000.
3	1999, Mayer, Peter, William DeOreo. Residential End Uses of Water. Published by AWWA Research Foundation and American Water Works Association. 1999.
4	2003, Mayer, Peter, William DeOreo. Residential Indoor Water Conservation Study. Aquacraft, Inc. Water Engineering and Management. Prepared for East Bay Municipal Utility District and the US EPA. July 2003.
5	2011, DeOreo, William. Analysis of Water Use in New Single Family Homes. By Aquacraft. For Salt Lake City Corporation and US EPA. July 20, 2011.
6	2011, Aquacraft. Albuquerque Single Family Water Use Efficiency and Retrofit Study. For Albuquerque Bernalillo County Water Utility Authority. December 1, 2011.
7	2008, Schultdt, Marc, and Debra Tachibana. Energy related Water Fixture Measurements: Securing the Baseline for Northwest Single Family Homes. 2008 ACEEE Summer Study on Energy Efficiency in Buildings.

MEASURE CODE: RS-HWE-LFFA-V15-250101

REVIEW DEADLINE: 1/1/2030

5.4.5 Low Flow Showerheads

DESCRIPTION

This measure relates to the installation of a low flow showerhead in a single or multi-family household.

This measure may be used for units provided through Efficiency Kits; however, the in-service rate for such measures should be derived through evaluation results specifically for this implementation methodology.

This measure was developed to be applicable to the following program types: TOS, RF, NC, DI, KITS.

If applied to other program types, the measure savings should be verified.

DEFINITION OF EFFICIENT EQUIPMENT

To qualify for this measure the installed equipment must be a low flow showerhead rated at least 0.5 gallons per minute (GPM) less than the existing showerhead. Savings are calculated on a per showerhead fixture basis.

DEFINITION OF BASELINE EQUIPMENT

For Direct install programs, the baseline condition is assumed to be a standard showerhead rated at 2.0 GPM or greater.

For retrofit and time-of-sale programs, the baseline condition is assumed to be a representative average of existing showerhead flow rates of participating customers including a range of low flow showerheads, standard-flow showerheads, and high-flow showerheads.

Average measured flow rates are used in the algorithm and are lower, reflecting the penetration of previously installed low flow fixtures (and therefore the freerider rate for this measure should be 0), use of the shower at less than full flow, debris buildup, and lower water system pressure than fixtures are rated at.

DEEMED LIFETIME OF EFFICIENT EQUIPMENT

The expected measure life is assumed to be 10 years.⁹³⁷

DEEMED MEASURE COST

For time of sale or new construction the incremental cost for this measure is \$7 or program actual.⁹³⁸

For low flow showerheads provided through Direct Install or within Efficiency Kits, the actual program delivery costs (including labor if applicable) should be utilized. If unknown assume \$12 for Direct Install⁹³⁹ and \$7 for Efficiency Kits.

LOADSHAPE

Loadshape R03 - Residential Electric DHW

COINCIDENCE FACTOR

The coincidence factor for this measure is assumed to be 2.78%.⁹⁴⁰

⁹³⁷ Table C-6, Measure Life Report, Residential and Commercial/Industrial Lighting and HVAC Measures, GDS Associates, June 2007. Evaluations indicate that consumer dissatisfaction may lead to reductions in persistence, particularly in Multifamily.

⁹³⁸ Market research average of \$7.

⁹³⁹ Includes assess and install labor time of \$5 (20min @ \$15/hr)

⁹⁴⁰ Calculated as follows: Assume 11% showers take place during peak hours (based on: Oreo et al, "The end uses of hot water in single family homes from flow trace analysis", 2001.). There are 65 days in the summer peak period, so the percentage of total annual aerator use in peak period is $0.11 * 65 / 365 = 1.96\%$. The number of hours of recovery during peak periods is therefore assumed to be $1.96\% * 369 = 7.23$ hours of recovery during peak period, where 369 equals the average annual electric DHW recovery hours for showerhead use including SF and MF homes with Direct Install and Retrofit/TOS measures. There are 260 hours in the peak period so the probability you will see savings during the peak period is $7.23 / 260 = 0.0278$

Algorithm

CALCULATION OF SAVINGS

ELECTRIC ENERGY SAVINGS

Note these savings are per showerhead fixture.

$$\Delta kWh = \%ElectricDHW * ((GPM_base * L_base - GPM_low * L_low) * Household * SPCD * 365.25 / SPH) * EPG_electric * ISR$$

Where:

- %ElectricDHW** = Percentage of DHW savings assumed to be electric
- = 100 % for Electric
- = 0 % for Fossil Fuel
- = If unknown⁹⁴¹, use the following table:

Utility	Location				
	Single Family	Single Family Low Income	Multi Family	Multi Family Low Income	Unknown
Ameren ⁹⁴²	24%	25%	40%	43%	28%
ComEd ⁹⁴³	8%		11%		9%
People’s Gas ⁹⁴⁴	2.0%	2.0%	1.7%	2.1%	2.0%
Northshore Gas ⁹⁴⁵	1.3%	1.8%	10.0%	2.4%	2.3%
Nicor Gas ⁹⁴⁶	1.3%	1.8%	10.0%	2.4%	2.3%
All DUs⁹⁴⁷					25%

Note: If a measure is supported by a gas and electric utility through a joint program, and it is unknown whether the participant has a gas supply, the electric utility values in the table above should be used. If it is known that the participant has a gas supply, the values from the gas utility above should be applied.

GPM_base = Average flow rate, in gallons per minute, of the baseline faucet “as-used.”

Note, if GPM_base is based upon the deemed assumptions below, since these include participants that had existing low flow fixtures, the freerider rate for this measure should be 0.

Program	GPM_base
Direct Install	2.24 ⁹⁴⁸

⁹⁴¹ Based on the average % electricity used for water heating in Unknown residential structure types across all utilities covered by the IL program. Residence types include: SF, SF LI, MF & MF LI. Utilities included: Ameren, ComEd, People’s Gas, Northshore Gas & Nicor. Please see subsequent table and citations for specific sources.

⁹⁴² Provided by AEG from the 2020 Market Potential Study completed for AIC, as well as AIC Income Qualified Initiative: 2021 Participant Survey Results Memo (February 1, 2022) p. 17.

⁹⁴³ Commonwealth Edison Residential Baseline Study (2020). p.4.4 & 4.19; Section 4-7 Water Heating. Prepared by Itron.

⁹⁴⁴ Implementation Contractors data from Peoples Gas and North Shore Gas for PY2022-2023.

⁹⁴⁵ Ibid.

⁹⁴⁶ Comparable service area & customers to NSG, therefore using their survey data.

⁹⁴⁷ For the weighted average calculations, please see the Analysis file. PGL, NSG, Nicor & gas customers were assumed to follow the provided split. ComEd total customers, minus overlap with PGL,NSG & Nicor, therefore electric only homes. Ameren is total customers minus Nicor.

⁹⁴⁸ Based on measurements conducted from June 2013 to January 2014 by Franklin Energy. Over 300 residential sites in the Chicago area were tested.

Program	GPM_base
Retrofit, Efficiency Kits, NC or TOS	2.35 ⁹⁴⁹

GPM_low = As-used flow rate of the low-flow showerhead, which may, as a result of measurements of program evaluations deviate from rated flows⁹⁵⁰

L_base = Shower length in minutes with baseline showerhead
= 7.8 min⁹⁵¹

L_low = Shower length in minutes with low-flow showerhead
= 7.8 min⁹⁵²

Household = Average number of people per household

Household Unit Type	Household ⁹⁵³		
	IQ Participants	Non-IQ Participants	All Participants
Single-Family - Deemed	2.76	2.62	2.67
Multifamily - Deemed	2.3	2.09	2.18
Household type unknown			2.52 ⁹⁵⁴
Custom	Actual Occupancy or Number of Bedrooms ⁹⁵⁵		

Use Multifamily if: Building meets utility’s definition for multifamily

SPCD = Showers Per Capita Per Day
= 0.6⁹⁵⁶

365.25 = Days per year, on average.

SPH = Showerheads Per Household so that per-showerhead savings fractions can be determined

Household Type	SPH
Single-Family except mobile homes	1.79 ⁹⁵⁷

⁹⁴⁹ Representative value from sources 1, 2, 4, 5, 6 and 7 (See Source Table at end of measure section) adjusted slightly upward to account for program participation which is expected to target customers with existing higher flow devices rather than those with existing low flow devices.

⁹⁵⁰ Note that actual values may be either a) program-specific minimum flow rate, or b) program-specific evaluation-based value of actual effective flow-rate due to increased duration or temperatures. The latter increases in likelihood as the rated flow drops and may become significant at or below rated flows of 1.5 GPM. The impact can be viewed as the inverse of the throttling described in the footnote for baseline flowrate.

⁹⁵¹ Cadmus and Opinion Dynamics Showerhead and Faucet Aerator Meter Study Memorandum dated June 2013, directed to Michigan Evaluation Working Group. This study of 135 single and Multifamily homes in Michigan metered energy parameters for efficient showerhead and faucet aerators.

⁹⁵² Ibid.

⁹⁵³ Assumptions are taken from the draft unadjusted 2024 Baseline Study evaluation data provided in 07/2024 by GDS Associates.

⁹⁵⁴ Unknown is based on statewide weighted average of 69% single family and 31% multifamily, based on IL data from 2009 RECS Table HC2.9 Structural and Geographic Characteristics of Homes in Midwest Region, Divisions and States, 2009.

⁹⁵⁵ Bedrooms are suitable proxies for household occupancy, and may be preferable to actual occupancy due to turnover rates in residency and non-adult population impacts.

⁹⁵⁶ Cadmus and Opinion Dynamics Showerhead and Faucet Aerator Meter Study Memorandum dated June 2013, directed to Michigan Evaluation Working Group.

⁹⁵⁷ Based on findings from a 2009 ComEd residential survey of 140 sites, provided by Cadmus.

Household Type	SPH
Multifamily and mobile homes	1.3 ⁹⁵⁸
Household type unknown	1.64 ⁹⁵⁹
Custom	Actual

Use Multifamily if: Building meets utility’s definition for multifamily

- EPG_electric = Energy per gallon of hot water supplied by electric
 = $(8.33 * 1.0 * (\text{ShowerTemp} - \text{SupplyTemp})) / (\text{RE_electric} * 3,412)$
 = $(8.33 * 1.0 * (101 - 50.7)) / (0.98 * 3,412)$
 = 0.125 kWh/gal
- 8.33 = Specific weight of water (lbs/gallon)
- 1.0 = Heat Capacity of water (btu/lb-°)
- ShowerTemp = Assumed temperature of water
 = 101°F⁹⁶⁰
- SupplyTemp = Assumed temperature of water entering house
 = 50.7°F⁹⁶¹
- RE_electric = Recovery efficiency of electric water heater
 = 98%⁹⁶²
- 3412 = Converts Btu to kWh (btu/kWh)
- ISR = In service rate of showerhead dependant on install method as listed in table below

⁹⁵⁸ Ibid.

⁹⁵⁹ Unknown is based on statewide weighted average of 69% single family and 31% multifamily, based on IL data from 2009 RECS Table HC2.9 Structural and Geographic Characteristics of Homes in Midwest Region, Divisions and States, 2009.

⁹⁶⁰ Cadmus and Opinion Dynamics Showerhead and Faucet Aerator Meter Study Memorandum dated June 2013, directed to Michigan Evaluation Working Group.

⁹⁶¹ Table 4 in Chen, et. al., “Calculating Average Hot Water Mixes of Residential Plumbing Fixtures”, June 2020, reports a value of 50.7°F for inlet water temperature for U.S. Census Division 3.

⁹⁶² Electric water heaters have recovery efficiency of 98%.

Selection	ISR
Direct Install	0.965 ⁹⁶³
Virtual Assessment followed by Unverified Self-Install	0.803 ⁹⁶⁴
Requested Efficiency Kits	0.65 ⁹⁶⁵
Distributed Efficiency Kits (Income Eligible)	0.48 ⁹⁶⁶
Distributed School Efficiency Kit showerhead	0.574 ⁹⁶⁷

For example, a direct installed 1.5 GPM low flow showerhead in a single family IQ home with electric DHW where the number of showers is not known:

$$\begin{aligned} \Delta kWh &= 1.0 * ((2.24 * 7.8 - 1.5 * 7.8) * 2.76 * 0.6 * 365.25 / 1.79) * 0.125 * 0.96 \\ &= 234 kWh \end{aligned}$$

Secondary kWh Savings for Water Supply and Wastewater Treatment

The following savings should be included in the total savings for this measure, but should not be included in TRC tests to avoid double counting the economic benefit of water savings.

$$\Delta kWh_{water} = \Delta Water \text{ (gallons)} / 1,000,000 * E_{water \text{ total}}$$

Where

$$\begin{aligned} E_{water \text{ total}} &= \text{IL Total Water Energy Factor (kWh/Million Gallons)} \\ &= 5,010^{968} \end{aligned}$$

⁹⁶³ Weighted average of 98% found in ComEd Energy Efficiency/ Demand Response Plan: Plan Year 2 (6/1/2009-5/31/2010) Evaluation Report: All Electric Single Family Home Energy Performance Tune-Up Program Table 3-8 (quantity surveyed = 163), and 87% from ComEd Single Family Retrofits CY2018 Field Work Memo 2019-07-19, Table 1 (quantity surveyed = 15). Alternative ISRs may be developed for program delivery methods based on evaluation results. Navigant, ComEd-Nicor Gas EPY4/GPY1 Multifamily Home Energy Savings Program Evaluation Report FINAL 2013-06-05. Opinion dynamics conducted primary research with tenants of participating multifamily buildings in 2023 to study the removal behavior of tenants post Program Ally direct install of low flow showerheads. Opinion Dynamics, “2023 AIC Multifamily Initiatives Tenant Survey Findings Memo”, Ameren Illinois, Multifamily Initiatives, April 24, 2024. These sources have been averaged to arrive at an ISR of 0.965.

⁹⁶⁴ An equal weighted average of Direct Install and Efficiency Kit ISRs. Interest and applicability of measures confirmed through virtual assessment. Average of homes using 1 Showerhead & 2 Showerhead.

⁹⁶⁵ A weighted ISR was found by weighting Nicor and Ameren efficiency kit program uptake and their previously found ISRs. This analysis can be found in Faucet Aerators and Showerheads Weighted Average ISR IL TRM.xlsx.

⁹⁶⁶ Average of Guidehouse survey research for Peoples Gas, June 16, 2020 and Research from 2021 Ameren Illinois Income Qualified participant survey, available on IL SAG website: <https://ilsag.s3.amazonaws.com/AIC-Income-Qualified-Initiative-Participant-Survey-Results-Memo-FINAL-2022-02-01.pdf>

⁹⁶⁷ Results from Home Energy Worksheets completed by student/families in 2020, 2021, and 2022 were nearly the same as values from: Opinion Dynamics and Cadmus. 2018 AIC Residential Program Annual Impact Evaluation Report. April 30, 2019. Results from implementer-administered participant survey. Home Energy Worksheets also establish the fraction of participants who indicate they “will install later” for specific measures. Follow-up research completed by Guidehouse for Nicor Gas in 2022 found that, on average, 51.3% of respondents who initially reported that they hadn’t installed specific kit measures, but “planned to” subsequently had installed the measures. Combining these findings allows for an ISR that accounts for initial and one round of subsequent intallations. To maintain a conservative estimate of ISR, the remaining 48.7% are presumed uninstalled. See: EESchoolKitSubsequentInstall_HEW.xlsx for data and calculations.

⁹⁶⁸ This factor includes 2571 kWh/MG for water supply based on Illinois energy intensity data from a 2012 ISAWWA study and 2439 kWh/MG for wastewater treatment based on national energy intensity use estimates. For more information please review Elevate Energy’s ‘IL TRM: Energy per Gallon Factor, May 2018 paper’.

For example, a direct installed 1.5 GPM low flow showerhead in a single family IQ home where the number of showers is not known:

$$\begin{aligned} \Delta\text{Water (gallons)} &= ((2.24 * 7.8 - 1.5 * 7.8) * 2.76 * 0.6 * 365.25 / 1.79) * 0.96 \\ &= 1,872 \text{ gallons} \\ \Delta\text{kWh}_{\text{water}} &= 1,872/1,000,000 * 5,010 \\ &= 9.4 \text{ kWh} \end{aligned}$$

SUMMER COINCIDENT PEAK DEMAND SAVINGS

$$\Delta\text{kW} = \Delta\text{kWh/Hours} * \text{CF}$$

Where:

ΔkWh = calculated value above. Note do not include the secondary savings in this calculation.

Hours = Annual electric DHW recovery hours for showerhead use

$$= ((\text{GPM}_{\text{base}} * \text{L}_{\text{base}}) * \text{Household} * \text{SPCD} * 365.25) * 0.726^{969} / \text{GPH}$$

$$= 273 \text{ for SF Direct Install; } 224 \text{ for MF Direct Install}$$

$$= 286 \text{ for SF Retrofit, Efficiency Kits, NC and TOS; } 236 \text{ for MF Retrofit, Efficiency Kits, NC and TOS}$$

Use Multifamily if: Building meets utility’s definition for multifamily

GPH = Gallons per hour recovery of electric water heater calculated for 69.3F temp rise (120-50.7), 98% recovery efficiency, and typical 4.5kW electric resistance storage tank.

$$= 26.1$$

CF = Coincidence Factor for electric load reduction

$$= 0.0278^{970}$$

For example, a direct installed 1.5 GPM low flow showerhead in a single family IQ home with electric DHW where the number of showers is not known:

$$\begin{aligned} \Delta\text{kW} &= 234/273 * 0.0278 \\ &= 0.024 \text{ kW} \end{aligned}$$

FOSSIL FUEL SAVINGS

$$\begin{aligned} \Delta\text{Therms} &= \% \text{FossilDHW} * ((\text{GPM}_{\text{base}} * \text{L}_{\text{base}} - \text{GPM}_{\text{low}} * \text{L}_{\text{low}}) * \text{Household} * \text{SPCD} \\ &\quad * 365.25 / \text{SPH}) * \text{EPG}_{\text{gas}} * \text{ISR} \end{aligned}$$

Where:

$\% \text{FossilDHW}$ = Percentage of DHW savings assumed to be fossil fuel

= 100 % for Fossil Fuel

= 0 % for Electric

⁹⁶⁹ 72.6% is the proportion of hot 120F water mixed with 50.7F supply water to give 101F shower water.

⁹⁷⁰ Calculated as follows: Assume 11% showers take place during peak hours (based on: Oreo et al, “The end uses of hot water in single family homes from flow trace analysis”, 2001.). There are 65 days in the summer peak period, so the percentage of total annual aerator use in peak period is 0.11*65/365 = 1.96%. The number of hours of recovery during peak periods is therefore assumed to be 1.96% * 369 = 7.23 hours of recovery during peak period where 369 equals the average annual electric DHW recovery hours for showerhead use including SF and MF homes with Direct Install and Retrofit/TOS measures. There are 260 hours in the peak period so the probability you will see savings during the peak period is 7.23/260 = 0.0278

= If unknown⁹⁷¹, use the following table:

Utility	Location				
	Single Family	Single Family Low Income	Multi Family	Multi Family Low Income	Unknown
Ameren ⁹⁷²	76%	75%	60%	57%	72%
ComEd ⁹⁷³	92%		89%		91%
People’s Gas ⁹⁷⁴	97.9%	98.0%	98.3%	97.6%	97.8%
Northshore Gas ⁹⁷⁵	98.5%	98.2%	90.0%	97.6%	97.6%
Nicor Gas ⁹⁷⁶	98.5%	98.2%	90.0%	97.6%	97.6%
All DUs⁹⁷⁷					75%

Note: If a measure is supported by a gas and electric utility through a joint program, and it is unknown whether the participant has a gas supply, the electric utility values in the table above should be used. If it is known that the participant has a gas supply, the values from the gas utility above should be applied.

EPG_gas = Energy per gallon of Hot water supplied by gas
 = $(8.33 * 1.0 * (\text{ShowerTemp} - \text{SupplyTemp})) / (\text{RE_gas} * 100,000)$
 = 0.0054 Therm/gal for SF homes
 = 0.0063 Therm/gal for MF homes

RE_gas = Recovery efficiency of gas water heater
 = 78% For individual water heater⁹⁷⁸
 = 67% For shared water heater⁹⁷⁹

If unknown, use individual water heater value for single family, use shared water heater value for multifamily. Use multifamily if building meets utility’s definition for multifamily.

100,000 = Converts Btus to Therms (btu/Therm)

Other variables as defined above.

⁹⁷¹ Based on the average % electricity used for water heating in Unknown residential structure types across all utilities covered by the IL program. Residence types include: SF, SF LI, MF & MF LI. Utilities included: Ameren, ComEd, People’s Gas, Northshore Gas & Nicor. Please see subsequent table and citations for specific sources.

⁹⁷² Provided by AEG from the 2020 Market Potential Study completed for AIC, as well as AIC Income Qualified Initiative: 2021 Participant Survey Results Memo (February 1, 2022) p. 17.

⁹⁷³ Commonwealth Edison Residential Baseline Study (2020). p.4.4 & 4.19; Section 4-7 Water Heating. Prepared by Itron.

⁹⁷⁴ Residential Appliance Saturation Survey of natural gas for space heating and water heating (2021). Note, Multifamily customers have a residential billing rate code and responded on the survey that they live in an apartment or condominium in a building that has either 2-4 or 5+ units.

⁹⁷⁵ Ibid.

⁹⁷⁶ Comparable service area & customers to NSG, therefore using their survey data.

⁹⁷⁷ For the weighted average calculations, please see the Analysis file. PGL, NSG, Nicor & gas customers were assumed to follow the provided split. ComEd total customers, minus overlap with PGL,NSG & Nicor, therefore gas only homes. Ameren is total customers minus Nicor.

⁹⁷⁸ DOE Final Rule discusses Recovery Efficiency with an average around 0.76 for Gas Fired Storage Water heaters and 0.78 for standard efficiency gas fired tankless water heaters up to 0.95 for the highest efficiency gas fired condensing tankless water heaters. These numbers represent the range of new units however, not the range of existing units in stock. Review of AHRI Directory suggests range of recovery efficiency ratings for new Gas DHW units of 70-87%. Average of existing units is estimated at 78%.

⁹⁷⁹ Water heating in Multifamily buildings is often provided by a larger central boiler. This suggests that the average recovery efficiency is somewhere between a typical central boiler efficiency of 0.59 and the 0.75 for single family homes. An average efficiency of 0.67 is used for this analysis as a default for Multifamily buildings.

For example, a direct installed 1.5 GPM low flow showerhead in a gas fired DHW single family home where the number of showers is not known:

$$\begin{aligned} \Delta\text{Therms} &= 1.0 * ((2.24 * 7.8 - 1.5 * 7.8) * 2.76 * 0.6 * 365.25 / 1.79) * 0.0054 * 0.96 \\ &= 10.1 \text{ therms} \end{aligned}$$

WATER IMPACT DESCRIPTIONS AND CALCULATION

$$\Delta\text{Water (gallons)} = ((\text{GPM_base} * \text{L_base} - \text{GPM_low} * \text{L_low}) * \text{Household} * \text{SPCD} * 365.25 / \text{SPH}) * \text{ISR}$$

Variables as defined above

For example, a direct installed 1.5 GPM low flow showerhead in a single family home where the number of showers is not known:

$$\begin{aligned} \Delta\text{Water (gallons)} &= ((2.24 * 7.8 - 1.5 * 7.8) * 2.76 * 0.6 * 365.25 / 1.79) * 0.96 \\ &= 1,872 \text{ gallons} \end{aligned}$$

DEEMED O&M COST ADJUSTMENT CALCULATION

N/A

SOURCES

Source ID	Reference
1	2011, DeOreo, William. California Single Family Water Use Efficiency Study. April 20, 2011.
2	2000, Mayer, Peter, William DeOreo, and David Lewis. Seattle Home Water Conservation Study. December 2000.
3	1999, Mayer, Peter, William DeOreo. Residential End Uses of Water. Published by AWWA Research Foundation and American Water Works Association. 1999.
4	2003, Mayer, Peter, William DeOreo. Residential Indoor Water Conservation Study. Aquacraft, Inc. Water Engineering and Management. Prepared for East Bay Municipal Utility District and the US EPA. July 2003.
5	2011, DeOreo, William. Analysis of Water Use in New Single Family Homes. By Aquacraft. For Salt Lake City Corporation and US EPA. July 20, 2011.
6	2011, Aquacraft. Albuquerque Single Family Water Use Efficiency and Retrofit Study. For Albuquerque Bernalillo County Water Utility Authority. December 1, 2011.
7	2008, Schultdt, Marc, and Debra Tachibana. Energy related Water Fixture Measurements: Securing the Baseline for Northwest Single Family Homes. 2008 ACEEE Summer Study on Energy Efficiency in Buildings.

MEASURE CODE: RS-HWE-LFSH-V14-250101

REVIEW DEADLINE: 1/1/2030

5.4.6 Water Heater Temperature Setback

DESCRIPTION

This measure was developed to be applicable to the following program types: NC, RF, DI, KITS.

If applied to other program types, the measure savings should be verified.

DEFINITION OF EFFICIENT EQUIPMENT

High efficiency is a hot water tank with the thermostat reduced to no lower than 120 degrees.

DEFINITION OF BASELINE EQUIPMENT

The baseline condition is a hot water tank with a thermostat setting that is higher than 120 degrees, typically systems with settings of 130 degrees or higher. Note if there are more than one DHW tanks in the home at or higher than 130 degrees and they are all turned down, then the savings per tank can be multiplied by the number of tanks.

DEEMED LIFETIME OF EFFICIENT EQUIPMENT

The assumed lifetime of the measure is 2 years.

DEEMED MEASURE COST

The incremental cost of a setback is assumed to be \$5 for contractor time, or where the measure is installed as part of a kit program, the cost of the informational insert or other product should be used.

LOADSHAPE

Loadshape R03 - Residential Electric DHW

COINCIDENCE FACTOR

The summer peak coincidence factor for this measure is assumed to be 1.

Algorithm

CALCULATION OF SAVINGS

ELECTRIC ENERGY SAVINGS

For homes with electric DHW tanks:

$$\Delta kWh^{980} = (U * A * (T_{pre} - T_{post}) * \text{Hours} * \text{ISR}) / (3412 * RE_{\text{electric}})$$

Where:

- U = Overall heat transfer coefficient of tank (Btu/Hr-°F-ft²).
= Actual if known. If unknown assume R-12, U = 0.083
- A = Surface area of storage tank (square feet)
= Actual if known. If unknown use table below based on capacity of tank. If capacity unknown assume 50 gal tank; A = 24.99ft²

⁹⁸⁰ Note this algorithm provides savings only from reduction in standby losses. The TAC considered avoided energy from not heating the water to the higher temperature but determined that dishwashers are likely to boost the temperature within the unit (roughly canceling out any savings), faucet and shower use is likely to be at the same temperature so there would need to be more lower temperature hot water being used (cancelling any savings) and clothes washers will only see savings if the water from the tank is taken without any temperature control. It was felt the potential impact was too small to be characterized.

Capacity (gal)	A (ft ²) ⁹⁸¹
30	19.16
40	23.18
50	24.99
80	31.84

Tpre = Actual hot water setpoint prior to adjustment

Tpost = Actual new hot water setpoint, which may not be lower than 120 degrees

Default Hot Water Temperature Inputs			
Delivery Method	System Type	Tpre	Tpost
Distributed school efficient kit instructions, Instructions provided in all other kit programs ^{982, 983}	Electric	143.0	139.1
	Gas	142.3	136.9
	Other	140.8	137.7
All other ⁹⁸⁴	Electric	143.0	139.1
	Gas	142.3	136.9
	Other	140.8	137.7

Hours = Number of hours in a year (since savings are assumed to be constant over year).
= 8766

ISR = In service rate of measure
= Dependent on program delivery method as listed in table below

Delivery Method	ISR
Distributed school efficient kit instructions	20% ⁹⁸⁵
Instructions provided in all other kit programs	10% ⁹⁸⁶
All other	100%

3412 = Conversion from Btu to kWh

RE_electric = Recovery efficiency of electric hot water heater
= 0.98⁹⁸⁷

Deemed savings assumptions for kit programs and non-kit programs are provided in the table below:

Deemed kWh Savings		
Delivery Method	System Type	ΔkWh
	Electric	4.24

⁹⁸¹ Assumptions from PA TRM. Area values were calculated from average dimensions of several commercially available units, with radius values measured to the center of the insulation.

⁹⁸² DHW Temperature Setpoint EEE Survey Data.pdf, Table 7

⁹⁸³ DHW Temperature Setpoint EEE Survey Data.pdf, Table 8

⁹⁸⁴ DHW Temperature Setpoint EEE Survey Data.pdf, Table 7

⁹⁸⁵ DHW Temperature Setpoint EEE Survey Data.pdf, Table 6

⁹⁸⁶ Ibid.

⁹⁸⁷ Electric water heaters have recovery efficiency of 98%.

Deemed kWh Savings		
Delivery Method	System Type	ΔkWh
Distributed school efficient kit instructions	Gas	5.87
	Other	3.37
All other kit programs	Electric	2.12
	Gas	2.94
	Other	1.69
Non-kit program	All	120.72

SUMMER COINCIDENT PEAK DEMAND SAVINGS

$$\Delta kW = \Delta kWh / \text{Hours} * CF$$

Where:

Hours = 8766

CF = Summer Peak Coincidence Factor for measure

= 1

Deemed savings assumptions for kit programs and non-kit programs are provided in the table below:

Deemed kW Savings		
Delivery Method	System Type	ΔkW
Distributed school efficient kit instructions	Electric	0.0005
	Gas	0.0007
	Other	0.0004
All other kit programs	Electric	0.0002
	Gas	0.0003
	Other	0.0002
Non-kit program	All	0.0138

FOSSIL FUEL SAVINGS

For homes with gas water heaters:

$$\Delta \text{Therms} = (U * A * (T_{pre} - T_{post}) * \text{Hours} * \text{ISR}) / (100,000 * \text{RE}_{gas})$$

Where

100,000 = Converts Btus to Therms (btu/Therm)

RE_{gas} = Recovery efficiency of gas water heater

= 78% For SF homes⁹⁸⁸

⁹⁸⁸ DOE Final Rule discusses Recovery Efficiency with an average around 0.76 for Gas Fired Storage Water heaters and 0.78 for standard efficiency gas fired tankless water heaters up to 0.95 for the highest efficiency gas fired condensing tankless water heaters. These numbers represent the range of new units however, not the range of existing units in stock. Review of AHRI

= 67% For MF homes⁹⁸⁹

Use Multifamily if: Building has shared DHW

Deemed savings for kit programs and non-kit programs, for both single-family and multi-family settings, are provided in the table below:

Deemed Fossil Fuel Savings			
Delivery Method	System Type	ΔTherms SF	ΔTherms MF
Distributed school efficient kit instructions	Electric	0.18	0.21
	Gas	0.25	0.29
	Other	0.14	0.17
All other kit programs	Electric	0.09	0.11
	Gas	0.13	0.15
	Other	0.07	0.08
Non-kit program	All	5.17	6.02

WATER IMPACT DESCRIPTIONS AND CALCULATION

N/A

DEEMED O&M COST ADJUSTMENT CALCULATION

N/A

MEASURE CODE: RS-HWE-TMPS-V09-240101

REVIEW DEADLINE: 1/1/2028

Directory suggests range of recovery efficiency ratings for new Gas DHW units of 70-87%. Average of existing units is estimated at 78%.

⁹⁸⁹ Water heating in Multifamily buildings is often provided by a larger central boiler. This suggests that the average recovery efficiency is somewhere between a typical central boiler efficiency of 0.59 and the 0.75 for single family homes. An average efficiency of 0.67 is used for this analysis as a default for Multifamily buildings.

5.4.7 Water Heater Wrap

DESCRIPTION

This measure relates to a Tank Wrap or insulation “blanket” that is wrapped around the outside of a hot water tank to reduce stand-by losses. This measure applies only for homes that have an electric water heater that is not already well insulated. Generally this can be determined based upon the appearance of the tank.⁹⁹⁰

This measure was developed to be applicable to the following program types: RF, DI.

If applied to other program types, the measure savings should be verified.

DEFINITION OF EFFICIENT EQUIPMENT

The measure is a properly installed, R-8 or greater insulating tank wrap to reduce standby energy losses from the tank to the surrounding ambient area.

DEFINITION OF BASELINE EQUIPMENT

The baseline is a standard electric domestic hot water tank without an additional tank wrap. Gas storage water heaters are excluded due to the limitations of retrofit wrapping and the associated impacts on reduced savings and safety.

DEEMED LIFETIME OF EFFICIENT EQUIPMENT

The measure life is assumed to be 5 years.⁹⁹¹

DEEMED MEASURE COST

The incremental cost for this measure will be the actual material cost of procuring and labor cost of installing the tank wrap.

LOADSHAPE

Loadshape R03 - Residential Electric DHW

COINCIDENCE FACTOR

This measure assumes a flat loadshape and as such the coincidence factor is 1.

Algorithm

CALCULATION OF SAVINGS

ELECTRIC ENERGY SAVINGS

For electric DHW systems:

$$\Delta kWh = ((1/ R_{base} - 1/ R_{insul}) * A_{base} * \Delta T * Hours) / (3412 * \eta_{DHW})$$

Where:

R_{base} = Overall thermal resistance coefficient prior to adding tank wrap (Hr-°F-ft²/BTU).

R_{insul} = Overall thermal resistance coefficient after addition of tank wrap (Hr-°F-ft²/BTU).

⁹⁹⁰ Visually determine whether it is insulated by foam (newer, rigid, and more effective) or fiberglass (older, gives to gently pressure, and not as effective)

⁹⁹¹ This estimate assumes the tank wrap is installed on an existing unit with 5 years remaining life.

- A_{base} = Surface area of storage tank prior to adding tank wrap (square feet)⁹⁹²
- ΔT = Average temperature difference between tank water and outside air temperature (°F)
= 60°F⁹⁹³
- Hours = Number of hours in a year (since savings are assumed to be constant over year).
= 8766
- 3412 = Conversion from Btu to kWh
- η_{DHW} = Recovery efficiency of electric hot water heater
= 0.98⁹⁹⁴

The following table has default savings for various tank capacity and pre and post R-VALUES.

Capacity (gal)	R _{base}	R _{insul}	A _{base} (ft ²) ⁹⁹⁵	ΔkWh	ΔkW
30	8	16	19.16	188	0.0215
30	10	18	19.16	134	0.0153
30	12	20	19.16	100	0.0115
30	8	18	19.16	209	0.0239
30	10	20	19.16	151	0.0172
30	12	22	19.16	114	0.0130
40	8	16	23.18	228	0.0260
40	10	18	23.18	162	0.0185
40	12	20	23.18	122	0.0139
40	8	18	23.18	253	0.0289
40	10	20	23.18	182	0.0208
40	12	22	23.18	138	0.0158
50	8	16	24.99	246	0.0280
50	10	18	24.99	175	0.0199
50	12	20	24.99	131	0.0149
50	8	18	24.99	273	0.0311
50	10	20	24.99	197	0.0224
50	12	22	24.99	149	0.0170
80	8	16	31.84	313	0.0357
80	10	18	31.84	223	0.0254
80	12	20	31.84	167	0.0190
80	8	18	31.84	348	0.0397
80	10	20	31.84	250	0.0286
80	12	22	31.84	190	0.0216

SUMMER COINCIDENT PEAK DEMAND SAVINGS

$$\Delta kW = \Delta kWh / 8766 * CF$$

Where:

$$\Delta kWh = kWh \text{ savings from tank wrap installation}$$

⁹⁹² Area includes tank sides and top to account for typical wrap coverage.

⁹⁹³ Assumes 125°F water leaving the hot water tank and average temperature of basement of 65°F.

⁹⁹⁴ Electric water heaters have recovery efficiency of 98%.

⁹⁹⁵ Assumptions from PA TRM. Area values were calculated from average dimensions of several commercially available units, with radius values measured to the center of the insulation. Area includes tank sides and top to account for typical wrap coverage.

8766 = Number of hours in a year (since savings are assumed to be constant over year).
CF = Summer Coincidence Factor for this measure
= 1.0

The table above has default kW savings for various tank capacity and pre and post R-values.

FOSSIL FUEL SAVINGS

N/A

WATER IMPACT DESCRIPTIONS AND CALCULATION

N/A

DEEMED O&M COST ADJUSTMENT CALCULATION

N/A

MEASURE CODE: RS-HWE-WRAP-V03-220101

REVIEW DEADLINE: 1/1/2026

5.4.8 Thermostatic Restrictor Shower Valve

DESCRIPTION

The measure is the installation of a thermostatic restrictor shower valve in a single or multi-family household. This is a valve attached to a residential showerhead which restricts hot water flow through the showerhead once the water reaches a set point (generally 95F or lower).

This measure was developed to be applicable to the following program types: RF, NC, DI. If applied to other program types, the measure savings should be verified.

DEFINITION OF EFFICIENT EQUIPMENT

To qualify for this measure the installed equipment must be a thermostatic restrictor shower valve installed on a residential showerhead.

DEFINITION OF BASELINE EQUIPMENT

The baseline equipment is the residential showerhead without the restrictor valve installed.

DEEMED LIFETIME OF EFFICIENT EQUIPMENT

The expected measure life is assumed to be 10 years.⁹⁹⁶

DEEMED MEASURE COST

The incremental cost of the measure should be the actual program cost (including labor if applicable), or \$35⁹⁹⁷ plus \$20 labor⁹⁹⁸ if not available.

LOADSHAPE

Loadshape R03 - Residential Electric DHW

COINCIDENCE FACTOR

The coincidence factor for this measure is assumed to be 0.22%.⁹⁹⁹

Algorithm

CALCULATION OF ENERGY SAVINGS

ELECTRIC ENERGY SAVINGS

$$\Delta kWh = \%ElectricDHW * ((GPM_base_S * L_showerdevice) * Household * SPCD * 365.25 / SPH) * EPG_electric * ISR$$

Where:

⁹⁹⁶ Assumptions based on NY TRM, Pacific Gas and Electric Company Work Paper PGECODHW113, and measure life of low-flow showerhead.

⁹⁹⁷ Based on actual cost of the showerstart tsv3 adapter from Evolve showerheads.

⁹⁹⁸ Estimate for contractor installation time.

⁹⁹⁹ Calculated as follows: Assume 11% showers take place during peak hours (based on: Oreo et al, "The end uses of hot water in single family homes from flow trace analysis", 2001.). There are 65 days in the summer peak period, so the percentage of total annual use in peak period is 0.11*65/365 = 1.96%. The number of hours of recovery during peak periods is therefore assumed to be 1.96% * 29.5 = 0.577 hours of recovery during peak period, where 29.5 equals the average annual electric DHW recovery hours for showerhead use prevented by the device including SF and MF homes with Direct Install and Retrofit/TOS measures. There are 260 hours in the peak period so the probability you will see savings during the peak period is 0.577/260 = 0.0022

%ElectricDHW = Percentage of DHW savings assumed to be electric
 = 100 % for Electric
 = 0 % for Fossil Fuel
 = If unknown¹⁰⁰⁰, use the following table:

Utility	Location				
	Single Family	Single Family Low Income	Multi Family	Multi Family Low Income	Unknown
Ameren ¹⁰⁰¹	24%	25%	40%	43%	28%
ComEd ¹⁰⁰²	8%		11%		9%
People’s Gas ¹⁰⁰³	2.0%	2.0%	1.7%	2.1%	2.0%
Northshore Gas ¹⁰⁰⁴	1.3%	1.8%	10.0%	2.4%	2.3%
Nicor Gas ¹⁰⁰⁵	1.3%	1.8%	10.0%	2.4%	2.3%
All DUs¹⁰⁰⁶					25%

Note: If a measure is supported by a gas and electric utility through a joint program, and it is unknown whether the participant has a gas supply, the electric utility values in the table above should be used. If it is known that the participant has a gas supply, the values from the gas utility above should be applied.

GPM_base_S = Flow rate of the basecase showerhead, or actual if available

Program	GPM
Direct-install, device only	2.24 ¹⁰⁰⁷
New Construction or direct install of device and low flow showerhead	Rated or actual flow of program-installed showerhead
Retrofit or TOS	2.35 ¹⁰⁰⁸

L_showerdevice = Hot water waste time avoided due to thermostatic restrictor valve
 = 0.89 minutes¹⁰⁰⁹

Household = Average number of people per household

¹⁰⁰⁰ Based on the average % electricity used for water heating in Unknown residential structure types across all utilities covered by the IL program. Residence types include: SF, SF LI, MF & MF LI. Utilities included: Ameren, ComEd, People’s Gas, Northshore Gas & Nicor. Please see subsequent table and citations for specific sources.

¹⁰⁰¹ Provided by AEG from the 2020 Market Potential Study completed for AIC, as well as AIC Income Qualified Initiative: 2021 Participant Survey Results Memo (February 1, 2022) p. 17.

¹⁰⁰² Commonwealth Edison Residential Baseline Study (2020). p.4.4 & 4.19; Section 4-7 Water Heating. Prepared by Itron.

¹⁰⁰³ Implementation Contractors data from Peoples Gas and North Shore Gas for PY2022-2023.

¹⁰⁰⁴ Ibid.

¹⁰⁰⁵ Comparable service area & customers to NSG, therefore using their survey data.

¹⁰⁰⁶ For the weighted average calculations, please see the Analysis file. PGL, NSG, Nicor & gas customers were assumed to follow the provided split. ComEd total customers, minus overlap with PGL,NSG & Nicor, therefore electric only homes. Ameren is total customers minus Nicor.

¹⁰⁰⁷ Based on measurements conducted from June 2013 to January 2014 by Franklin Energy. Over 300 residential sites in the Chicago area were tested.

¹⁰⁰⁸ Representative value from sources 1, 2, 4, 5, 6 and 7 (See Source Table at end of measure section) adjusted slightly upward to account for program participation which is expected to target customers with existing higher flow devices rather than those with existing low flow devices.

¹⁰⁰⁹ Average of the following sources: ShowerStart LLC survey; “Identifying, Quantifying and Reducing Behavioral Waste in the Shower: Exploring the Savings Potential of ShowerStart”, City of San Diego Water Department survey; “Water Conservation Program: ShowerStart Pilot Project White Paper”, and PG&E Work Paper PGECODHW113.

Household Unit Type	Household ¹⁰¹⁰		
	IQ Participants	Non-IQ Participants	All Participants
Single-Family - Deemed	2.76	2.62	2.67
Multifamily - Deemed	2.3	2.09	2.18
Household type unknown			2.52 ¹⁰¹¹
Custom	Actual Occupancy or Number of Bedrooms ¹⁰¹²		

Use Multifamily if: Building meets utility’s definition for multifamily

SPCD = Showers Per Capita Per Day
 = 0.6¹⁰¹³

365.25 = Days per year, on average.

SPH = Showerheads Per Household so that per-showerhead savings fractions can be determined

Household Type	SPH
Single-Family	1.79 ¹⁰¹⁴
Multifamily	1.3 ¹⁰¹⁵
Household type unknown	1.64 ¹⁰¹⁶
Custom	Actual

Use Multifamily if: Building meets utility’s definition for multifamily

EPG_electric = Energy per gallon of hot water supplied by electric
 = $(8.33 * 1.0 * (\text{ShowerTemp} - \text{SupplyTemp})) / (\text{RE_electric} * 3412)$
 = $(8.33 * 1.0 * (101 - 50.7)) / (0.98 * 3412)$
 = 0.125 kWh/gal

8.33 = Specific weight of water (lbs/gallon)

1.0 = Heat Capacity of water (btu/lb-°)

ShowerTemp = Assumed temperature of water
 = 101F¹⁰¹⁷

SupplyTemp = Assumed temperature of water entering house

¹⁰¹⁰ Assumptions are taken from the draft unadjusted 2024 Baseline Study evaluation data provided in 07/2024 by GDS Associates.

¹⁰¹¹ Unknown is based on statewide weighted average of 69% single family and 31% multifamily, based on IL data from 2009 RECS Table HC2.9 Structural and Geographic Characteristics of Homes in Midwest Region, Divisions and States, 2009.

¹⁰¹² Bedrooms are suitable proxies for household occupancy, and may be preferable to actual occupancy due to turnover rates in residency and non-adult population impacts.

¹⁰¹³ Cadmus and Opinion Dynamics Showerhead and Faucet Aerator Meter Study Memorandum dated June 2013, directed to Michigan Evaluation Working Group.

¹⁰¹⁴ Based on findings from a 2009 ComEd residential survey of 140 sites, provided by Cadmus.

¹⁰¹⁵ Ibid.

¹⁰¹⁶ Unknown is based on statewide weighted average of 69% single family and 31% multifamily, based on IL data from 2009 RECS Table HC2.9 Structural and Geographic Characteristics of Homes in Midwest Region, Divisions and States, 2009.

¹⁰¹⁷ Cadmus and Opinion Dynamics Showerhead and Faucet Aerator Meter Study Memorandum dated June 2013, directed to Michigan Evaluation Working Group.

- = 50.7°F ¹⁰¹⁸
- RE_electric = Recovery efficiency of electric water heater
= 98% ¹⁰¹⁹
- 3412 = Converts Btu to kWh (btu/kWh)
- ISR = In service rate of showerhead
= Dependent on program delivery method as listed in table below

Selection	ISR
Direct Install - Single Family	0.98 ¹⁰²⁰
Direct Install – Multi Family	0.95 ¹⁰²¹
Efficiency Kits	To be determined through evaluation

Use Multifamily if: Building meets utility’s definition for multifamily

For example, a direct installed valve in a single-family IQ home with electric DHW:

$$\Delta kWh = 1.0 * (2.24 * 0.89 * 2.76 * 0.6 * 365.25 / 1.79) * 0.125 * 0.98$$

$$= 82.5 \text{ kWh}$$

Secondary kWh Savings for Water Supply and Wastewater Treatment

The following savings should be included in the total savings for this measure, but should not be included in TRC tests to avoid double counting the economic benefit of water savings.

$$\Delta kWh_{\text{water}} = \Delta \text{Water (gallons)} / 1,000,000 * E_{\text{water total}}$$

Where

$$E_{\text{water total}} = \text{IL Total Water Energy Factor (kWh/Million Gallons)}$$

$$= 5,010^{1022}$$

For example, a direct installed thermostatic restrictor device in a single family IQ home where the number of showers is not known:

$$\Delta \text{Water (gallons)} = ((2.24 * 0.89) * 2.76 * 0.6 * 365.25 / 1.79) * 0.98$$

$$= 660 \text{ gallons}$$

$$\Delta kWh_{\text{water}} = 660 / 1,000,000 * 5,010$$

$$= 3.3 \text{ kWh}$$

¹⁰¹⁸ Table 4 in Chen, et. al., “Calculating Average Hot Water Mixes of Residential Plumbing Fixtures”, June 2020, reports a value of 50.7°F for inlet water temperature for U.S. Census Division 3.

¹⁰¹⁹ Electric water heaters have recovery efficiency of 98%.

¹⁰²⁰ Deemed values are from ComEd Energy Efficiency/ Demand Response Plan: Plan Year 2 (6/1/2009-5/31/2010) Evaluation Report: All Electric Single Family Home Energy Performance Tune-Up Program Table 3-8. Alternative ISRs may be developed for program delivery methods based on evaluation results.

¹⁰²¹ Navigant, ComEd-Nicor Gas EPY4/GPY1 Multifamily Home Energy Savings Program Evaluation Report FINAL 2013-06-05

¹⁰²² This factor include 2571 kWh/MG for water supply based on Illinois energy intensity data from a 2012 ISAWWA study and 2439 kWh/MG for wastewater treatment based on national energy intensity use estimates. For more information please review Elevate Energy’s ‘IL TRM: Energy per Gallon Factor, May 2018 paper’.

SUMMER COINCIDENT PEAK DEMAND SAVINGS

$$\Delta kW = \Delta kWh/Hours * CF$$

Where:

ΔkWh = calculated value above. Note do not include the secondary savings in this calculation.

Hours = Annual electric DHW recovery hours for wasted showerhead use prevented by device

$$= ((GPM_base_S * L_showerdevice) * Household * SPCD * 365.25) * 0.726^{1023} / GPH$$

GPH = Gallons per hour recovery of electric water heater calculated for 69.3F temp rise (120-50.7), 98% recovery efficiency, and typical 4.5kW electric resistance storage tank.

$$= 26.1$$

$$= 31.1 \text{ for SF Direct Install; } 25.5 \text{ for MF Direct Install}$$

$$= 32.6 \text{ for SF Retrofit and TOS; } 26.7 \text{ for MF Retrofit and TOS}$$

Use Multifamily if: Building meets utility’s definition for multifamily

CF = Coincidence Factor for electric load reduction

$$= 0.0022^{1024}$$

For example, a direct installed thermostatic restrictor device in a single family IQ home with electric DHW where the number of showers is not known.

$$\Delta kW = 82.5/31.1 * 0.0022$$

$$= 0.0058 \text{ kW}$$

FOSSIL FUEL SAVINGS

$$\Delta Therms = \%FossilDHW * ((GPM_base_S * L_showerdevice) * Household * SPCD * 365.25 / SPH) * EPG_gas * ISR$$

Where:

$\%FossilDHW$ = Percentage of DHW savings assumed to be fossil fuel

= 100 % for Fossil Fuel

= 0 % for Electric

= If unknown¹⁰²⁵, use the following table:

¹⁰²³ 72.6% is the proportion of hot 120F water mixed with 50.7F supply water to give 101F shower water.

¹⁰²⁴ Calculated as follows: Assume 11% showers take place during peak hours (based on: Oreo et al, “The end uses of hot water in single family homes from flow trace analysis”, 2001.). There are 65 days in the summer peak period, so the percentage of total annual use in peak period is $0.11 * 65 / 365 = 1.96\%$. The number of hours of recovery during peak periods is therefore assumed to be $1.96\% * 29.5 = 0.577$ hours of recovery during peak period, where 29.5 equals the average annual electric DHW recovery hours for showerhead use prevented by the device including SF and MF homes with Direct Install and Retrofit/TOS measures. There are 260 hours in the peak period so the probability you will see savings during the peak period is $0.577 / 260 = 0.0022$

¹⁰²⁵ Based on the average % electricity used for water heating in Unknown residential structure types across all utilities covered by the IL program. Residence types include: SF, SF LI, MF & MF LI. Utilities included: Ameren, ComEd, People’s Gas, Northshore Gas & Nicor. Please see subsequent table and citations for specific sources.

Utility	Location				
	Single Family	Single Family Low Income	Multi Family	Multi Family Low Income	Unknown
Ameren ¹⁰²⁶	76%	75%	60%	57%	72%
ComEd ¹⁰²⁷	92%		89%		91%
People’s Gas ¹⁰²⁸	97.9%	98.0%	98.3%	97.6%	97.8%
Northshore Gas ¹⁰²⁹	98.5%	98.2%	90.0%	97.6%	97.6%
Nicor Gas ¹⁰³⁰	98.5%	98.2%	90.0%	97.6%	97.6%
All DUs¹⁰³¹					75%

Note: If a measure is supported by a gas and electric utility through a joint program, and it is unknown whether the participant has a gas supply, the electric utility values in the table above should be used. If it is known that the participant has a gas supply, the values from the gas utility above should be applied.

- EPG_gas = Energy per gallon of Hot water supplied by gas

$$= (8.33 * 1.0 * (\text{ShowerTemp} - \text{SupplyTemp})) / (\text{RE_gas} * 100,000)$$
 - = 0.0054 Therm/gal for SF homes
 - = 0.0063 Therm/gal for MF homes
- RE_gas = Recovery efficiency of gas water heater
 - = 78% For SF homes¹⁰³²
 - = 67% For MF homes¹⁰³³
 - Use Multifamily if: Building has shared DHW.
- 100,000 = Converts Btus to Therms (btu/Therm)
 Other variables as defined above.

¹⁰²⁶ Provided by AEG from the 2020 Market Potential Study completed for AIC, as well as AIC Income Qualified Initiative: 2021 Participant Survey Results Memo (February 1, 2022) p. 17.

¹⁰²⁷ Commonwealth Edison Residential Baseline Study (2020). p.4.4 & 4.19; Section 4-7 Water Heating. Prepared by Itron.

¹⁰²⁸ Residential Appliance Saturation Survey of natural gas for space heating and water heating (2021). Note, Multifamily customers have a residential billing rate code and responded on the survey that they live in an apartment or condominium in a building that has either 2-4 or 5+ units.

¹⁰²⁹ Ibid.

¹⁰³⁰ Comparable service area & customers to NSG, therefore using their survey data.

¹⁰³¹ For the weighted average calculations, please see the Analysis file. PGL, NSG, Nicor & gas customers were assumed to follow the provided split. ComEd total customers, minus overlap with PGL,NSG & Nicor, therefore gas only homes. Ameren is total customers minus Nicor.

¹⁰³² DOE Final Rule discusses Recovery Efficiency with an average around 0.76 for Gas Fired Storage Water heaters and 0.78 for standard efficiency gas fired tankless water heaters up to 0.95 for the highest efficiency gas fired condensing tankless water heaters. These numbers represent the range of new units however, not the range of existing units in stock. Review of AHRI Directory suggests range of recovery efficiency ratings for new Gas DHW units of 70-87%. Average of existing units is estimated at 78%.

¹⁰³³ Water heating in Multifamily buildings is often provided by a larger central boiler. This suggests that the average recovery efficiency is somewhere between a typical central boiler efficiency of 0.59 and the 0.75 for single family homes. An average efficiency of 0.67 is used for this analysis as a default for Multifamily buildings.

For example, a direct installed thermostatic restrictor device in a gas fired DHW single family IQ home where the number of showers is not known:

$$\begin{aligned} \Delta\text{Therms} &= 1.0 * ((2.24 * 0.89) * 2.76 * 0.6 * 365.25 / 1.79) * 0.0054 * 0.98 \\ &= 3.6 \text{ therms} \end{aligned}$$

WATER IMPACT DESCRIPTIONS AND CALCULATION

$$\begin{aligned} \Delta\text{Water (gallons)} &= ((\text{GPM_base_S} * \text{L_showerdevice}) * \text{Household} * \text{SPCD} * 365.25 / \text{SPH}) * \text{ISR} \\ &\text{Variables as defined above} \end{aligned}$$

For example, a direct installed thermostatic restrictor device in a single family IQ home where the number of showers is not known:

$$\begin{aligned} \Delta\text{Water (gallons)} &= ((2.24 * 0.89) * 2.76 * 0.6 * 365.25 / 1.79) * 0.98 \\ &= 660 \text{ gallons} \end{aligned}$$

DEEMED O&M COST ADJUSTMENT CALCULATION

N/A

SOURCES

Source ID	Reference
1	2011, DeOreo, William. California Single Family Water Use Efficiency Study. April 20, 2011.
2	2000, Mayer, Peter, William DeOreo, and David Lewis. Seattle Home Water Conservation Study. December 2000.
3	1999, Mayer, Peter, William DeOreo. Residential End Uses of Water. Published by AWWA Research Foundation and American Water Works Association. 1999.
4	2003, Mayer, Peter, William DeOreo. Residential Indoor Water Conservation Study. Aquacraft, Inc. Water Engineering and Management. Prepared for East Bay Municipal Utility District and the US EPA. July 2003.
5	2011, DeOreo, William. Analysis of Water Use in New Single Family Homes. By Aquacraft. For Salt Lake City Corporation and US EPA. July 20, 2011.
6	2011, Aquacraft. Albuquerque Single Family Water Use Efficiency and Retrofit Study. For Albuquerque Bernalillo County Water Utility Authority. December 1, 2011.
7	2008, Schultdt, Marc, and Debra Tachibana. Energy related Water Fixture Measurements: Securing the Baseline for Northwest Single Family Homes. 2008 ACEEE Summer Study on Energy Efficiency in Buildings.
8	2011, Lutz, Jim. "Water and Energy Wasted During Residential Shower Events: Findings from a Pilot Field Study of Hot Water Distribution Systems", Energy Analysis Department Lawrence Berkeley National Laboratory, September 2011.
9	2008, Water Conservation Program: ShowerStart Pilot Project White Paper, City of San Diego, CA.
10	2012, Pacific Gas and Electric Company, Work Paper PGECODHW113, Low Flow Showerhead and Thermostatic Shower Restriction Valve, Revision # 4, August 2012.
11	2008, "Simply & Cost Effectively Reducing Shower Based Warm-Up Waste: Increasing Convenience & Conservation by Attaching ShowerStart to Existing Showerheads", ShowerStart LLC.
12	2014, New York State Record of Revision to the TRM, Case 07-M-0548, June 19, 2014.

MEASURE CODE: RS-HWE-TRVA-V09-250101

REVIEW DEADLINE: 1/1/2028

5.4.9 Shower Timer

DESCRIPTION

Shower Timers are designed to make it easy for people to consistently take short showers, resulting in water and energy savings.

The shower timer provides a reminder to participants on length of their shower visually or auditorily.

This measure was developed to be applicable to the following program type: KITS, DI.

If applied to other program types, the measure savings should be verified.

DEFINITION OF EFFICIENT EQUIPMENT

The shower timer should provide a reminder to participants to keep showers to a length of 5 minutes or less.

DEFINITION OF BASELINE EQUIPMENT

The baseline is no shower timer.

DEEMED LIFETIME OF EFFICIENT EQUIPMENT

The deemed lifetime is 2 years.¹⁰³⁴

DEEMED MEASURE COST

For shower timers provided in Efficiency Kits, the actual program delivery costs should be utilized.

LOADSHAPE

Loadshape R03 - Residential Electric DHW

COINCIDENCE FACTOR

The coincidence factor for this measure is assumed to be 2.78%.¹⁰³⁵

Algorithm

CALCULATION OF ENERGY SAVINGS

ELECTRIC ENERGY SAVINGS

$$\Delta kWh = \%Electric\ DHW * GPM * (L_base - L_timer) * Household * Days/yr * SPCD * UsageFactor * EPG_Electric$$

Where:

- $\%Electric\ DHW$ = Percentage of DHW savings assumed to be electric
- = 100 % for Electric
- = 0 % for Fossil Fuel

¹⁰³⁴ Estimate of persistence of behavior change instigated by the shower timer.

¹⁰³⁵ Calculated as follows: Assume 11% showers take place during peak hours (based on: Oreo et al, "The end uses of hot water in single family homes from flow trace analysis", 2001.). There are 65 days in the summer peak period, so the percentage of total annual aerator use in peak period is $0.11 * 65 / 365 = 1.96\%$. The number of hours of recovery during peak periods is therefore assumed to be $1.96\% * 369 = 7.23$ hours of recovery during peak period, where 369 equals the average annual electric DHW recovery hours for showerhead use including SF and MF homes with Direct Install and Retrofit/TOS measures. There are 260 hours in the peak period so the probability you will see savings during the peak period is $7.23 / 260 = 0.0278$

= If unknown¹⁰³⁶, use the following table:

Utility	Location				
	Single Family	Single Family Low Income	Multi Family	Multi Family Low Income	Unknown
Ameren ¹⁰³⁷	24%	25%	40%	43%	28%
ComEd ¹⁰³⁸	8%		11%		9%
People’s Gas ¹⁰³⁹	2.0%	2.0%	1.7%	2.1%	2.0%
Northshore Gas ¹⁰⁴⁰	1.3%	1.8%	10.0%	2.4%	2.3%
Nicor Gas ¹⁰⁴¹	1.3%	1.8%	10.0%	2.4%	2.3%
All DUs¹⁰⁴²					25%

Note: If a measure is supported by a gas and electric utility through a joint program, and it is unknown whether the participant has a gas supply, the electric utility values in the table above should be used. If it is known that the participant has a gas supply, the values from the gas utility above should be applied.

- GPM = Flow rate of showerhead as used
- = Custom, to be determined through evaluation. If data is not available use 1.93¹⁰⁴³
- L_base = Number of minutes in shower without a shower timer
- =7.8 minutes¹⁰⁴⁴
- L_timer = Number of minutes in shower after shower timer
- = Custom, to be determined through evaluation. If data is not available use 5.79.¹⁰⁴⁵
- Household = Number in household using timer

Household Unit Type	Household ¹⁰⁴⁶		
	IQ Participants	Non-IQ Participants	All Participants
Single-Family - Deemed	2.76	2.62	2.67
Multifamily - Deemed	2.3	2.09	2.18
Household type unknown			2.52 ¹⁰⁴⁷

¹⁰³⁶ Based on the average % electricity used for water heating in Unknown residential structure types across all utilities covered by the IL program. Residence types include: SF, SF LI, MF & MF LI. Utilities included: Ameren, ComEd, People’s Gas, Northshore Gas & Nicor. Please see subsequent table and citations for specific sources.

¹⁰³⁷ Provided by AEG from the 2020 Market Potential Study completed for AIC, as well as AIC Income Qualified Initiative: 2021 Participant Survey Results Memo (February 1, 2022) p. 17.

¹⁰³⁸ Commonwealth Edison Residential Baseline Study (2020). p.4.4 & 4.19; Section 4-7 Water Heating. Prepared by Itron.

¹⁰³⁹ Implementation Contractors data from Peoples Gas and North Shore Gas for PY2022-2023.

¹⁰⁴⁰ Ibid.

¹⁰⁴¹ Comparable service area & customers to NSG, therefore using their survey data.

¹⁰⁴² For the weighted average calculations, please see the Analysis file. PGL, NSG, Nicor & gas customers were assumed to follow the provided split. ComEd total customers, minus overlap with PGL,NSG & Nicor, therefore electric only homes. Ameren is total customers minus Nicor.

¹⁰⁴³ Navigant Elementary Education GPY4 Evaluation Report, dated May 12, 2016. Average of all utilities.

¹⁰⁴⁴ Cadmus and Opinion Dynamics Showerhead and Faucet Aerator Meter Study Memorandum dated June 2013, directed to Michigan Evaluation Working Group. This study of 135 single and Multifamily homes in Michigan metered energy parameters for efficient showerhead and faucet aerators.

¹⁰⁴⁵ Navigant Elementary Education GPY4 Evaluation Report, dated May 12, 2016. Average of all utilities.

¹⁰⁴⁶ Assumptions are taken from the draft unadjusted 2024 Baseline Study evaluation data provided in 07/2024 by GDS Associates.

¹⁰⁴⁷ Unknown is based on statewide weighted average of 69% single family and 31% multifamily, based on IL data from 2009 RECS Table HC2.9 Structural and Geographic Characteristics of Homes in Midwest Region, Divisions and States, 2009.

Household Unit Type	Household ¹⁰⁴⁶		
	IQ Participants	Non-IQ Participants	All Participants
Custom	Actual Occupancy or Number of Bedrooms ¹⁰⁴⁸		

Days/yr = 365.25

SPCD = Showers Per Capita Per Day
= 0.6¹⁰⁴⁹

UsageFactor = How often each participant is using shower timer
= Custom, to be determined through evaluation. If data is not available use 0.34¹⁰⁵⁰

EPG_Electric = Energy per gallon of hot water supplied by electric
= $(8.33 * 1.0 * (\text{ShowerTemp} - \text{SupplyTemp})) / (\text{RE_electric} * 3412)$
= $(8.33 * 1.0 * (101 - 50.7)) / (0.98 * 3412)$
= 0.125 kWh/gal

Where:

ShowerTemp = Assumed temperature of water
= 101°F¹⁰⁵¹

SupplyTemp = Assumed temperature of water entering house
= 50.7°F¹⁰⁵²

Based on default assumptions provided above, the savings for a single family IQ home would be:

$$\begin{aligned} \Delta\text{kWh} &= \% \text{Electric DHW} * \text{GPM} * (\text{L_base} - \text{L_timer}) * \text{Household} * \text{Days/yr} * \text{SPCD} * \text{UsageFactor} \\ &\quad * \text{EPG_Electric} \\ &= 0.25 * 1.93 * (7.8 - 5.79) * 2.76 * 365.25 * 0.6 * 0.34 * 0.125 \\ &= 24.9 \text{ kWh} \end{aligned}$$

Secondary kWh Savings for Water Supply and Wastewater Treatment

The following savings should be included in the total savings for this measure, but should not be included in TRC tests to avoid double counting the economic benefit of water savings.

$$\Delta\text{kWh}_{\text{water}} = \Delta\text{Water (gallons)} / 1,000,000 * E_{\text{water total}}$$

Where

E_{water total} = IL Total Water Energy Factor (kWh/Million Gallons)
= 5,010¹⁰⁵³

¹⁰⁴⁸ Bedrooms are suitable proxies for household occupancy, and may be preferable to actual occupancy due to turnover rates in residency and non-adult population impacts.

¹⁰⁴⁹ Cadmus and Opinion Dynamics Showerhead and Faucet Aerator Meter Study Memorandum dated June 2013, directed to Michigan Evaluation Working Group.

¹⁰⁵⁰ Navigant Elementary Education GPY4 Evaluation Report, dated May 12, 2016. Average of all utilities.

¹⁰⁵¹ Cadmus and Opinion Dynamics Showerhead and Faucet Aerator Meter Study Memorandum dated June 2013, directed to Michigan Evaluation Working Group.

¹⁰⁵² Table 4 in Chen, et. al., "Calculating Average Hot Water Mixes of Residential Plumbing Fixtures", June 2020, reports a value of 50.7°F for inlet water temperature for U.S. Census Division 3.

¹⁰⁵³ This factor include 2571 kWh/MG for water supply based on Illinois energy intensity data from a 2012 ISAWWA study and

Based on default assumptions provided above, the savings for a single family IQ home would be:

$$\begin{aligned} \Delta\text{Water (gallons)} &= \text{GPM} * (\text{L_base} - \text{L_timer}) * \text{Household} * \text{Days/yr} * \text{SPCD} * \text{UsageFactor} \\ &= 1.93 * (7.8 - 5.79) * 2.76 * 365.25 * 0.6 * 0.34 \\ &= 797.8 \text{ gallons} \\ \Delta\text{kWh}_{\text{water}} &= 797.8/1,000,000 * 5010 \\ &= 4.0 \text{ kWh} \end{aligned}$$

SUMMER COINCIDENT PEAK DEMAND SAVINGS

$$\Delta\text{kW} = \Delta\text{kWh/Hours} * \text{CF}$$

Where:

$$\begin{aligned} \Delta\text{kWh} &= \text{calculated value above. Note do not include the secondary savings in this calculation.} \\ \text{Hours} &= \text{Annual electric DHW recovery hours for showerhead use} \\ &= (\text{GPM_base} * \text{L_base} * \text{Household} * \text{SPCD} * \text{UsageFactor} * 365.25) * 0.726^{1054} / \text{GPH} \\ \text{GPH} &= \text{Gallons per hour recovery of electric water heater calculated for 69.3F temp rise (120-50.7), 98\% recovery efficiency, and typical 4.5kW electric resistance storage tank.} \\ &= 26.1 \\ \text{CF} &= \text{Coincidence Factor for electric load reduction} \\ &= 0.0278^{1055} \end{aligned}$$

Based on default assumptions provided above, the savings for a single family IQ home would be:

$$\begin{aligned} \text{Hours} &= (1.93 * 7.8 * 2.76 * 0.6 * 0.34 * 365.25) * 0.726/26.1 \\ &= 86.1 \text{ Hours} \\ \Delta\text{kW} &= \Delta\text{kWh/Hours} * \text{CF} \\ &= 24.9 / 86.1 * 0.0278 \\ &= 0.0080 \text{ kW} \end{aligned}$$

FOSSIL FUEL SAVINGS

$$\begin{aligned} \Delta\text{Therms} &= \% \text{FossilDHW} * \text{GPM} * (\text{L_base} - \text{L_timer}) * \text{Household} * \text{Days/yr} * \text{SPCD} * \text{UsageFactor} * \text{EPG_Gas} \\ \% \text{FossilDHW} &= \text{Percentage of DHW savings assumed to be fossil fuel} \\ &= 100 \% \text{ for Fossil Fuel} \end{aligned}$$

2439 kWh/MG for wastewater treatment based on national energy intensity use estimates. For more information please review Elevate Energy's 'IL TRM: Energy per Gallon Factor, May 2018 paper'.

¹⁰⁵⁴ 72.6% is the proportion of hot 120F water mixed with 50.7F supply water to give 101F shower water.

¹⁰⁵⁵ Calculated as follows: Assume 11% showers take place during peak hours (based on: Oreo et al, "The end uses of hot water in single family homes from flow trace analysis", 2001.). There are 65 days in the summer peak period, so the percentage of total annual aerator use in peak period is 0.11*65/365 = 1.96%. The number of hours of recovery during peak periods is therefore assumed to be 1.96% * 369 = 7.23 hours of recovery during peak period where 369 equals the average annual electric DHW recovery hours for showerhead use including SF and MF homes with Direct Install and Retrofit/TOS measures. There are 260 hours in the peak period so the probability you will see savings during the peak period is 7.23/260 = 0.0278

= 0 % for Electric

= If unknown¹⁰⁵⁶, use the following table:

Utility	Location				
	Single Family	Single Family Low Income	Multi Family	Multi Family Low Income	Unknown
Ameren ¹⁰⁵⁷	76%	75%	60%	57%	72%
ComEd ¹⁰⁵⁸	92%		89%		91%
People’s Gas ¹⁰⁵⁹	97.9%	98.0%	98.3%	97.6%	97.8%
Northshore Gas ¹⁰⁶⁰	98.5%	98.2%	90.0%	97.6%	97.6%
Nicor Gas ¹⁰⁶¹	98.5%	98.2%	90.0%	97.6%	97.6%
All DUs¹⁰⁶²					75%

Note: If a measure is supported by a gas and electric utility through a joint program, and it is unknown whether the participant has a gas supply, the electric utility values in the table above should be used. If it is known that the participant has a gas supply, the values from the gas utility above should be applied.

EPG_gas = Energy per gallon of Hot water supplied by gas
 = $(8.33 * 1.0 * (\text{ShowerTemp} - \text{SupplyTemp})) / (\text{RE_gas} * 100,000)$
 = 0.00537 Therm/gal for SF homes
 = 0.00625 Therm/gal for MF homes

RE_gas = Recovery efficiency of gas water heater
 = 78% For SF homes¹⁰⁶³
 = 67% For MF homes¹⁰⁶⁴

Use Multifamily if: Building has shared DHW.

100,000 = Converts Btus to Therms (btu/Therm)

¹⁰⁵⁶ Based on the average % electricity used for water heating in Unknown residential structure types across all utilities covered by the IL program. Residence types include: SF, SF LI, MF & MF LI. Utilities included: Ameren, ComEd, People’s Gas, Northshore Gas & Nicor. Please see subsequent table and citations for specific sources.

¹⁰⁵⁷ Provided by AEG from the 2020 Market Potential Study completed for AIC, as well as AIC Income Qualified Initiative: 2021 Participant Survey Results Memo (February 1, 2022) p. 17.

¹⁰⁵⁸ Commonwealth Edison Residential Baseline Study (2020). p.4.4 & 4.19; Section 4-7 Water Heating. Prepared by Itron.

¹⁰⁵⁹ Residential Appliance Saturation Survey of natural gas for space heating and water heating (2021). Note, Multifamily customers have a residential billing rate code and responded on the survey that they live in an apartment or condominium in a building that has either 2-4 or 5+ units.

¹⁰⁶⁰ Ibid.

¹⁰⁶¹ Comparable service area & customers to NSG, therefore using their survey data.

¹⁰⁶² For the weighted average calculations, please see the Analysis file. PGL, NSG, Nicor & gas customers were assumed to follow the provided split. ComEd total customers, minus overlap with PGL,NSG & Nicor, therefore gas only homes. Ameren is total customers minus Nicor.

¹⁰⁶³ DOE Final Rule discusses Recovery Efficiency with an average around 0.76 for Gas Fired Storage Water heaters and 0.78 for standard efficiency gas fired tankless water heaters up to 0.95 for the highest efficiency gas fired condensing tankless water heaters. These numbers represent the range of new units however, not the range of existing units in stock. Review of AHRI Directory suggests range of recovery efficiency ratings for new Gas DHW units of 70-87%. Average of existing units is estimated at 78%.

¹⁰⁶⁴ Water heating in Multifamily buildings is often provided by a larger central boiler. This suggests that the average recovery efficiency is somewhere between a typical central boiler efficiency of 0.59 and the 0.75 for single family homes. An average efficiency of 0.67 is used for this analysis as a default for Multifamily buildings.

Other variables as defined above.

Based on default assumptions provided above, the savings for a single family IQ home would be:

$$\begin{aligned} \Delta \text{ Therms} &= \%FossilDHW * GPM * (L_base - L_timer) * Household * Days/yr * SPCD * UsageFactor \\ &\quad * EPG_Gas \\ &= 0.75 * 1.93 * (7.8 - 5.79) * 2.76 * 365.25 * 0.6 * 0.34 * 0.00537 \\ &= 3.2 \text{ Therms} \end{aligned}$$

WATER DESCRIPTIONS AND CALCULATION

$$\Delta \text{Water (gallons)} = GPM * (L_base - L_timer) * Household * Days/yr * SPCD * UsageFactor$$

Variables as defined above

Based on default assumptions provided above, the savings for a single family home would be:

$$\begin{aligned} \Delta \text{Water (gallons)} &= GPM * (L_base - L_timer) * Household * Days/yr * SPCD * UsageFactor \\ &= 1.93 * (7.8 - 5.79) * 2.76 * 365.25 * 0.6 * 0.34 \\ &= 797.8 \text{ gallons} \end{aligned}$$

DEEMED O&M COST ADJUSTMENT CALCULATION

N/A

MEASURE CODE: RS-DHW-SHTM-V07-250101

REVIEW DEADLINE: 1/1/2026

5.4.10 Pool Covers

DESCRIPTION

This measure refers to the installation of covers on residential use pools that are heated with gas-fired equipment located either indoors or outdoors. By installing pool covers, the heating load on the pool boiler will be reduced by reducing the heat loss from the water to the environment and the amount of actual water lost due to evaporation (which then requires additional heated water to make up for it). An additional benefit to pool covers are the electricity savings from the reduced fresh water required to replace the evaporated water.

The main source of energy loss in pools is through evaporation. This is particularly true of outdoor pools where wind plays a larger role. The point of installing pool covers is threefold. First, it will reduce convective losses due to the wind by shielding the water surface. Second, it will insulate the water from the colder surrounding air. And third, it will reduce radiative losses to the night sky. In doing so, evaporative losses will also be minimized, and the boiler will not need to work as hard in replenishing the pool with hot water to keep the desired temperature.

This measure can be used for pools that (1) currently do not have pool covers, (2) have pool covers that are past the useful life of the existing cover, or (3) have pool covers that are past their warranty period and have failed.

This measure was developed to be applicable to the following program type: RF. If applied to other program types, the measure savings should be verified.

DEFINITION OF EFFICIENT EQUIPMENT

For indoor pools, the efficient case is the installation of an indoor pool cover with a 5 year warranty on an indoor pool that is used all year.

For outdoor pools, the efficient case is the installation of an outdoor pool cover with a 5 year warranty on an outdoor pool that is used through the summer season.

DEFINITION OF BASELINE EQUIPMENT

For indoor pools, the base case is an uncovered indoor pool that operates all year.

For outdoor pools, the base case is an outdoor pool that is uncovered and is open through the summer season.

DEEMED LIFETIME OF EFFICIENT EQUIPMENT

The useful life of this measure is assumed to be 6 years.¹⁰⁶⁵

DEEMED MEASURE COST

The table below shows the costs for the various options and cover sizes. Since this measure covers a mix of various sizes, the average cost of these options is taken to be the incremental measure cost.¹⁰⁶⁶ Costs are per square foot.

Cover Size	Edge Style	
	Hemmed (indoor)	Weighted (outdoor)
1-299 sq. ft.	\$3.86	\$3.12
300-999 sq. ft.	\$3.50	\$2.16
Average	\$3.68	\$2.64

LOADSHAPE

Loadshape R15 – Residential Pool Pumps

¹⁰⁶⁵ The effective useful life of a pool cover is typically one year longer than its warranty period. SolaPool Covers. Pool Covers Website, FAQ- "How long will my SolaPool cover blanket last?". Pool covers are typically offered with 3 and 5 year warranties with at least one company offering a 6 year warranty. Conversation with Trade Ally. Knorr Systems

¹⁰⁶⁶ Pool Cover Costs derived from three leading online realtors, see Pool Covers Costs.xlsx .

COINCIDENCE FACTOR

N/A

Algorithm

CALCULATION OF ENERGY SAVINGS

ELECTRIC ENERGY SAVINGS

Secondary kWh Savings for Water Supply and Wastewater Treatment

The following savings should be included in the total savings for this measure, but should not be included in TRC tests to avoid double counting the economic benefit of water savings.

$$\Delta kWh_{water} = \Delta Water \text{ (gallons)} / 1,000,000 * E_{water \text{ supply}}$$

Where

$$E_{water \text{ supply}} = \text{Water Supply Energy Factor (kWh/Million Gallons)}$$

$$= 2,571^{1067}$$

For example:

For a 392 ft² Indoor Swimming Pool:

$$\begin{aligned} \Delta Water &= \text{WaterSavingFactor} \times \text{Size of Pool} \\ &= 15.28 \text{ gal./ft}^2/\text{year} \times 392 \text{ ft}^2 \\ &= 5,990 \text{ gal./year} \end{aligned}$$

$$\begin{aligned} \Delta kWh_{water} &= \Delta Water / 1,000,000 * E_{water \text{ total}} \\ &= 5,990 \text{ gal./year} / 1,000,000 * 2,571 \text{ kWh/million gallons} \\ &= 15.4 \text{ kWh/year} \end{aligned}$$

For a 392 ft² Outdoor Swimming Pool:

$$\begin{aligned} \Delta Water &= \text{WaterSavingFactor} \times \text{Size of Pool} \\ &= 8.94 \text{ gal./ft}^2/\text{year} \times 392 \text{ ft}^2 \\ &= 3,504 \text{ gal./year} \end{aligned}$$

$$\begin{aligned} \Delta kWh_{water} &= \Delta Water / 1,000,000 * E_{water \text{ supply}} \\ &= 3,504 \text{ gal./year} / 1,000,000 * 2,571 \text{ kWh/million gallons} \\ &= 9.0 \text{ kWh/year} \end{aligned}$$

SUMMER COINCIDENT PEAK DEMAND SAVINGS

N/A

FOSSIL FUEL SAVINGS

The calculations are based on modeling runs using RSPEC! Energy Smart Pools Software that was created by the U.S. Department of Energy.¹⁰⁶⁸

¹⁰⁶⁷ This factor include 2571 kWh/MG for water supply based on Illinois energy intensity data from a 2012 ISAWWA study. For more information please review Elevate Energy’s ‘IL TRM: Energy per Gallon Factor, May 2018 paper’. Note since the water loss associated with this measure is due to evaporation and does not discharge into the wastewater system, only the water supply factor is used here.

¹⁰⁶⁸ Full method and supporting information found in reference document: IL TRM – Residential Pool Covers WorkPaper.docx. Note that the savings estimates are based upon Chicago weather data.

$$\Delta\text{Therms} = \text{SavingFactor} \times \text{Size of Pool}$$

Where

Savings factor = dependant on pool location and listed in table below:¹⁰⁶⁹

Location	Therm / sq-ft
Indoor	2.61
Outdoor	1.01

Size of Pool = Actual. If unknown assume 392 ft² ¹⁰⁷⁰

WATER IMPACT DESCRIPTIONS AND CALCULATION

$$\Delta\text{Water (gallons)} = \text{WaterSavingFactor} \times \text{Size of Pool}$$

Where

WaterSavingFactor = Water savings for this measure dependant on pool location and listed in table below:¹⁰⁷¹

Location	Annual Savings Gal / sq-ft
Indoor	15.28
Outdoor	8.94

Size of Pool = 392 ft²

DEEMED O&M COST ADJUSTMENT CALCULATION

There are no O&M cost adjustments for this measure.

MEASURE CODE: RS-HWE-PLCV-V02-240101

REVIEW DEADLINE: 1/1/2029

¹⁰⁶⁹ Calculations can be found in Residential Pool Covers.xlsx

¹⁰⁷⁰ The average size of an installed in-ground swimming pool is 14 ft x 28 ft, giving a surface area of 392 ft².
<<https://www.homeadvisor.com/cost/swimming-pools-hot-tubs-and-saunas/inground-pool/>>

¹⁰⁷¹ Ibid.

5.4.11 Drain Water Heat Recovery

DESCRIPTION

Drain Water Heat Recovery (DWHR) is a technology that captures waste heat in the drain line during a shower event, using the reclaimed heat to preheat cold water that is then delivered either to the shower or the water heater. The device can be installed in either an equal flow configuration (with preheated water being routed to both the water heater and the shower) or an unequal flow configuration (preheated water directed to either the water heater or shower). The energy harvested from a DWHR device is maximized in an equal flow configuration. It uses a non-regenerative heat exchanger to pre-heat the incoming cold fresh water with the outgoing warm drain water. It has been proven that DWHR devices only recover energy during simultaneous draws,¹⁰⁷² i.e., showers, and that for energy savings purposes all other water draws can be ignored. Savings are calculated per drain water heat recovery unit. Other benefits include increased first-hour rating of water tank, improved comfort due to slower temperature degradation at run-out and reduction of coincident peak demand.¹⁰⁷³

This measure was developed to be applicable to the following program types: RF, NC. If applied to other program types, the measure savings should be verified.

DEFINITION OF EFFICIENT EQUIPMENT

Efficient equipment is a DWHR unit retrofitted to the main drain which includes outlets from showers, sinks and other fixtures too. Note, that the DWHR unit can either be installed in a vertical configuration or a horizontal configuration. Although, this measure covers both horizontal and vertical DWHR,¹⁰⁷⁴ the energy savings calculations focuses on vertical. Due to the lack of any moving parts, no maintenance is required for either types of DWHR units. Vertical units are said to comprise 95% of the market currently.¹⁰⁷⁵

The device can be installed in either an equal flow configuration or an unequal flow configuration. An equal flow installation is ideal with all the incoming cold water passing through the DWHR heat exchanger apparatus, after which it splits into cold water and inlet to water heater. Units should be installed in single-family homes and multi-family homes.

DEFINITION OF BASELINE EQUIPMENT

The baseline condition is a storage type water heater without DWHR devices in a residential application.

DEEMED LIFETIME OF EFFICIENT EQUIPMENT

The measure life is assumed to be 30 years.¹⁰⁷⁶

DEEMED MEASURE COST

The incremental cost for this measure is \$744 per unit.¹⁰⁷⁷

LOADSHAPE

Load Shape R03 – Residential Electric DHW

¹⁰⁷² Charles Zaloum, John Gusdorf, and Anil Parekh; “Performance Evaluation of Drain Water Heat Recovery Technology at the Canadian Centre for Housing Technology”, January 2007, accessed April 2020.

¹⁰⁷³ G.Proskiw, “Technology Profile: Residential Greywater Heat Recovery Systems”, June 1998, accessed April 2020.

¹⁰⁷⁴ 2019 Title 24, Part 6 CASE Report. “Drain Water Heat Recovery – Final Report.”

¹⁰⁷⁵ Ibid

¹⁰⁷⁶ Ibid

¹⁰⁷⁷ 2019 Title 24, Part 6 CASE Report. “Drain Water Heat Recovery – Final Report.”, average of 4 ft and 5 ft units. Page 21.

COINCIDENCE FACTOR

The coincidence factor for this measure is assumed to be 2.78%.¹⁰⁷⁸

Algorithm

CALCULATION OF ENERGY SAVINGS

ELECTRIC ENERGY SAVINGS

For electric water heating, annual energy savings per unit are calculated through the following formula:

$$\Delta kWh = \frac{(ShowerTemp - SupplyTemp) \times 8.33 \frac{BTU}{gal \cdot ^\circ F} \times GPM \times T_{shower-length} \times Household \times N_{units} \times SPCD \times 365.25 \frac{days}{yr} \times SF}{3412 \frac{BTU}{kWh} \times RE}$$

Where:

- ShowerTemp = assumed water temperature during shower
= 101°F¹⁰⁷⁹
- SupplyTemp = assumed temperature of cold water entering house
= 50.7°F¹⁰⁸⁰
- 8.33 = Energy required (BTU) to heat one gallon of water by one degree Fahrenheit
- GPM = gallon per minute, flow rate of showerhead
= 2.35 Gallon/minute¹⁰⁸¹
- T_{shower-length} = shower length in minutes
= 7.8 minutes¹⁰⁸²
- Household = average number of people per household

Household Unit Type	Household ¹⁰⁸³		
	IQ Participants	Non-IQ Participants	All Participants
Single-Family - Deemed	2.76	2.62	2.67
Multifamily - Deemed	2.3	2.09	2.18
Household type unknown			2.52 ¹⁰⁸⁴

¹⁰⁷⁸ Assume coincidence factor for DWHR units is the same with that of low flow showerheads (see Illinois Statewide Technical Reference Manual for Energy Efficiency, section 5.4.5, low flow showerheads)

¹⁰⁷⁹ Cadmus and Opinion Dynamics Showerhead and Faucet Aerator Meter Study Memorandum dated June 2013, directed to Michigan Evaluation Working Group.

¹⁰⁸⁰ US DOE Building America Program, Building America Analysis Spreadsheet (for Chicago, IL), Office of Energy Efficiency & Renewable Energy.

¹⁰⁸¹ Current Illinois Statewide Technical Reference Manual for Energy Efficiency, section 5.4.5, low flow showerheads, for Retrofit and New Construction

¹⁰⁸² Cadmus and Opinion Dynamics Showerhead and Faucet Aerator Meter Study Memorandum dated June 2013, directed to Michigan Evaluation Working Group. This study of 135 single and Multifamily homes in Michigan metered energy parameters for efficient showerhead and faucet aerators.

¹⁰⁸³ Assumptions are taken from the draft unadjusted 2024 Baseline Study evaluation data provided in 07/2024 by GDS Associates.

¹⁰⁸⁴ Unknown is based on statewide weighted average of 69% single family and 31% multifamily, based on IL data from 2009 RECS Table HC2.9 Structural and Geographic Characteristics of Homes in Midwest Region, Divisions and States, 2009.

Household Unit Type	Household ¹⁰⁸³		
	IQ Participants	Non-IQ Participants	All Participants
Custom	Actual Occupancy or Number of Bedrooms ¹⁰⁸⁵		

N_{units} = Number of units in a multifamily building with drains connected to the DWHR unit

Household Unit	N _{units}
Single-Family	1
Multi-Family	1 or Actual

SPCD = Showers Per Capita Per Day
= 0.6¹⁰⁸⁶

365.25 = Days per year, on average.

SF = Water heating energy savings factor
= 0.466¹⁰⁸⁷

3,412 = Conversion factor, 1 kWh equals 3,412 BTU

RE = Recovery efficiency of electric water heater:
= Actual or:
= 0.98¹⁰⁸⁸ for Electric Resistance
= 3.51¹⁰⁸⁹ for Electric HPWH

For example, for electric water heating, DHWR energy savings for a single family IQ home can be calculated as follows:

$$\Delta kWh = ((101 - 50.7) * 8.33 * 2.35 * 7.8 * 2.76 * 1 * 0.6 * 365.25 * 0.466) / (3412 * 0.98)$$

$$= 647.4kWh$$

SUMMER COINCIDENT PEAK DEMAND SAVINGS

$$\Delta kW = \Delta kWh/Hours * CF$$

Where:

ΔkWh = calculated value from above.

Hours = Annual electric DHW recovery hours for showerhead use

$$= ((GPM * T_{shower-length}) * N_{persons} * SPCD * 365.25) * 0.726^{1090} / GPH$$

¹⁰⁸⁵ Bedrooms are suitable proxies for household occupancy, and may be preferable to actual occupancy due to turnover rates in residency and non-adult population impacts.

¹⁰⁸⁶ Cadmus and Opinion Dynamics Showerhead and Faucet Aerator Meter Study Memorandum dated June 2013, directed to Michigan Evaluation Working Group.

¹⁰⁸⁷ Codes and Standards Enhancement (CASE) Initiative, 2019 California Building Energy Efficiency Standards, Title 24, Part 6 Report. "Drain Water Heat Recovery - Final Report." July 2017, pg 17.

¹⁰⁸⁸ Review of AHRI database shows that electric water heaters have a recovery efficiency of 98%.

¹⁰⁸⁹ Review of AHRI database shows that Electric Heat Pump Water Heaters support this recovery efficiency. For the raw data, and calculations, please see AHRI_RES Water Heaters 2022.xlsx.

¹⁰⁹⁰ 72.6% is the proportion of hot 120F water mixed with 50.7F supply water to give 101F shower water.

= 286 for SF

= 234 for MF

Use Multifamily if: Building meets utility’s definition for multifamily

GPH = Gallons per hour recovery of electric water heater calculated for 69.3°F temp rise (120-50.7), 98% recovery efficiency, and typical 4.5kW electric resistance storage tank.

= 26.1

CF = Coincidence Factor for electric load reduction

= 0.0278

For example, When a DHWR unit is installed in a Single Family home, summer coincident peak demand savings can be calculated as follows:

$$\Delta kW = (647.4 / 286) * 0.0278$$

$$= 0.0629 \text{ kW}$$

FOSSIL FUEL SAVINGS

For gas water heating, annual energy savings per unit are calculated through the following formula:

$$\Delta \text{therms} = \frac{(\text{ShowerTemp} - \text{SupplyTemp}) \times 8.33 \frac{\text{BTU}}{\text{gal} \cdot \text{F}} \times \text{GPM} \times T_{\text{shower-length}} \times N_{\text{persons}} \times N_{\text{units}} \times \text{SPCD} \times 365.25 \frac{\text{days}}{\text{yr}} \times \text{SF}}{100,000 \frac{\text{BTU}}{\text{therm}} \times \text{RE}}$$

Where:

100,000 = Conversion factor, 1 therm equals 100,000 BTU

RE = efficiency of gas water heater: 79% for single family¹⁰⁹¹ and 67% for multi family¹⁰⁹²

For example, for gas water heating, DHWR energy savings for single family IQ home can be calculated as follows:

$$\Delta \text{Therms} = ((101 - 50.7) * 8.33 * 2.35 * 7.8 * 2.76 * 1 * 0.6 * 365.25 * 0.466) / (100000 * 0.79)$$

$$= 27.4 \text{ therms}$$

WATER AND OTHER NON-ENERGY IMPACT DESCRIPTIONS AND CALCULATION

N/A

DEEMED O&M COST ADJUSTMENT CALCULATION

N/A

MEASURE CODE: RS-DHW-DWHR-V05-250101

REVIEW DEADLINE: 1/1/2026

¹⁰⁹¹ DOE Final Rule discusses Recovery Efficiency with an average around 0.76 for Gas Fired Storage Water heaters and 0.78 for standard efficiency gas fired tankless water heaters up to 0.95 for the highest efficiency gas fired condensing tankless water heaters. These numbers represent the range of new units however, not the range of existing units in stock. Review of AHRI Directory suggests range of recovery efficiency ratings for new Gas DHW units of 70-87%. Average of existing units is estimated at 79%.

¹⁰⁹² Water heating in Multifamily buildings is often provided by a larger central boiler. This suggests that the average recovery efficiency is somewhere between a typical central boiler efficiency of 0.59 and the 0.75 for single family homes. An average efficiency of 0.67 is used for this analysis as a default for Multifamily buildings.

5.4.12 Recirculating Pump Controls

DESCRIPTION

Demand control recirculation pumps seek to reduce inefficiency by combining control via temperature and demand inputs, whereby the controller will not activate the recirculation pump unless both (a) the recirculation loop return water has dropped below a prescribed temperature (e.g., 100°F) and (b) a Central Domestic Hot Water (CDHW) demand is sensed as water flow through the CDHW system.

This measure was developed to be applicable to the following program types: TOS, RF, NC. If applied to other program types, the measure savings should be verified.

DEFINITION OF EFFICIENT EQUIPMENT

Re-circulating pump shall cycle on based on (a) the recirculation loop return water dropping below a prescribed temperature (e.g. 100°F) and (b) a CDHW demand is sensed as water flow through the CDHW system.

There are three alternative technologies that are considered in this characterization:

- Timer-based. This technology allows the user to program a schedule to perform recirculation during specific windows throughout the day.
- Aquastat-controlled. This type of control calls for recirculation when the water temperature at one point in the system falls below a certain pre-programmed setpoint.
- On-Demand. This technology senses the demand as water flow through the CDHW system. These types of system are most adequate on small central water heating systems.

DEFINITION OF BASELINE EQUIPMENT

The base case for this measure category is existing, uncontrolled recirculation pumps on either electric or gas-fired Central Domestic Hot Water systems (CDHW).

DEEMED LIFETIME OF EFFICIENT EQUIPMENT

The effective useful life is 15 years.¹⁰⁹³

DEEMED MEASURE COST

The average cost of the demand controller circulation kit is \$150 with an installation cost of \$72 for a total measure cost of \$222.¹⁰⁹⁴

LOADSHAPE

Loadshape R03 - Residential Electric DHW

COINCIDENCE FACTOR

N/A

¹⁰⁹³ Benningfield Group. (2009). *PY 2009 Monitoring Report: Demand Control for Multifamily Central Domestic Hot Water*. Folsom, CA: Prepared for Southern California Gas Company, October 30, 2009.

¹⁰⁹⁴ The incremental cost is sourced as a weighted average of control types, as sourced from the Northwest Power and Conservation Council, Regional Technical Forum, Unit Energy Savings Measures, Circulator Pump, December 5, 2023 ('ComResCirculatorPumps_v4_0.xlsm')

Algorithm

CALCULATION OF ENERGY SAVINGS

ELECTRIC ENERGY SAVINGS

$$\Delta kWh = \Delta kWh_{heater} * + \Delta kWh_{pump}$$

$$\Delta kWh_{heater} = \frac{(T_{out} - T_{in}) * GPD * Household * 365.25 * \gamma Water * 1 * \left(\frac{1}{UEF_{heater}}\right)}{3412} * SF$$

Where:

T_{OUT} = Tank temperature
= 125°F

T_{IN} = Incoming water temperature from well or municiple system
= 50.7°F¹⁰⁹⁵

GPD = Gallons hot water per day per person
= 17.6 gallons per day¹⁰⁹⁶

Household = Average number of people per household

Household Unit Type	Household ¹⁰⁹⁷		
	IQ Participants	Non-IQ Participants	All Participants
Single-Family - Deemed	2.76	2.62	2.67
Multifamily - Deemed	2.3	2.09	2.18
Household type unknown			2.52 ¹⁰⁹⁸
Custom	Actual Occupancy or Number of Bedrooms ¹⁰⁹⁹		

γ Water = Specific weight capacity of water (lb/gal)
= 8.33 lbs/gal

1 = Specific heat of water (Btu/lb.°F)

UEF_{heater} = Rated efficiency of water heater expressed as Uniform Energy Factor (UEF);

Note, the same draw pattern (very small, low, medium and high draw) should be used for both baseline and efficient units.

¹⁰⁹⁵ Table 4 in Chen, et. al., "Calculating Average Hot Water Mixes of Residential Plumbing Fixtures", June 2020, reports a value of 50.7°F for inlet water temperature for U.S. Census Division 3.

¹⁰⁹⁶ Deoreo, B., and P. Mayer. Residential End Uses of Water Study Update. Forthcoming. ©2015 Water Research Foundation. Reprinted With Permission.

¹⁰⁹⁷ Assumptions are taken from the draft unadjusted 2024 Baseline Study evaluation data provided in 07/2024 by GDS Associates.

¹⁰⁹⁸ Unknown is based on statewide weighted average of 69% single family and 31% multifamily, based on IL data from 2009 RECS Table HC2.9 Structural and Geographic Characteristics of Homes in Midwest Region, Divisions and States, 2009.

¹⁰⁹⁹ Bedrooms are suitable proxies for household occupancy, and may be preferable to actual occupancy due to turnover rates in residency and non-adult population impacts.

Equipment Type	Sub Category	Draw Pattern	Federal Standard – Uniform Energy Factor ¹¹⁰⁰
Residential Electric Storage Water Heaters ≤ 75,000 Btu/h	≤55 gallon tanks	Very small	UEF = 0.8808 – (0.0008 * Rated Storage Volume in Gallons)
		Low	UEF = 0.9254 – (0.0003 * Rated Storage Volume in Gallons)
		Medium	UEF = 0.9307 – (0.0002 * Rated Storage Volume in Gallons)
		High	UEF = 0.9349 – (0.0001 * Rated Storage Volume in Gallons)
	>55 gallon and ≤120 gallon tanks ¹¹⁰¹	Very small	UEF = 1.9236 – (0.0011 * Rated Storage Volume in Gallons)
		Low	UEF = 2.0440 – (0.0011 * Rated Storage Volume in Gallons)
		Medium	UEF = 2.1171 – (0.0011 * Rated Storage Volume in Gallons)
		High	UEF = 2.2418 – (0.0011 * Rated Storage Volume in Gallons)
Residential Electric Instantaneous Water Heaters	≤12kW and ≤2 gal	All other	UEF = 0.91
		High	UEF = 0.92
Residential-duty Commercial Electric Instantaneous Water Heaters	> 12kW and ≤58.6 kW and ≤2 gal	All	UEF = 0.80

Draw patterns are based on first hour rating (gallons) for storage tanks and maximum flow (GPM) for instantaneous as shown below:¹¹⁰²

Storage Water Heater Draw Pattern	
Draw Pattern	First Hour Rating (gallons)
Very Small	≥ 0 and < 18
Low	≥ 18 and < 51
Medium	≥ 51 and < 75
High	≥ 75

Instantaneous Water Heater Draw Pattern	
Draw Pattern	Max GPM
Very Small	≥ 0 and < 1.7
Low	≥ 1.7 and < 2.8
Medium	≥ 2.8 and < 4
High	≥ 4

3412 = Converts Btu to kWh

SF = Savings factor based on Building type

Building Type	Savings Factor ¹¹⁰³
Single-Family - Deemed	9%
Multifamily - Deemed	9%

¹¹⁰⁰ All Residential sized Federal Standards are from DOE Standard 10 CFR 430, Residential-Duty and Commercial Federal Standard are from DOE Standard 10 CFR 431.

¹¹⁰¹ It is assumed that tanks <75,000Btu/h and >55 gallons will not be eligible measures due to the high baseline.

¹¹⁰² Definitions provided in 10 CFR 430, Subpart B, Appendix E, Section 5.4.1.

¹¹⁰³ The savings factor from ACEEE Hot Water Forum. Control Methods, Code Requirements and Energy Savings. 9% is assumed to be the savings factor for multifamily and Single-Family buildings.

$$\Delta kW h_{pump} = \frac{HP_{recirculating} * 0.75 * (8760 - Pump_{hrs\ controlled})}{Motor_{eff}}$$

Where:

- HP_{recirculating} = the size of the recirculating pump in HP
= Actual. If unknown, default to 1/12 hp¹¹⁰⁴
- 0.75 = Conversion factor kW/HP
- 8760 = Hours of operation of uncontrolled recirculating pump
- Pump_{hrs controlled} = The table below corresponds to the control types for residences

Hours of operation ¹¹⁰⁵	
Timer	7,300
Aquastat-Controlled	1,095
On Demand	61

- Motor_{eff} = The efficiency of the pump motor
= Actual, if unknown, default to 70%¹¹⁰⁶

FOSSIL FUEL SAVINGS

Natural gas energy savings are calculated for natural gas storage water heaters per the equations given below.

$$\Delta Therms = \frac{(T_{out} - T_{in}) * HotWaterUse_{Gallon} * \gamma_{Water} * 1 * \left(\frac{1}{EF_{Gas}}\right)}{100,000} * SF$$

Where:

- 100,000 = Converts Btu to Therms
- EF_{gas} = Rated efficiency of baseline water heater (expressed as Uniform Energy Factor (UEF) or Thermal Efficiency as provided below).
Use actual or the minimum efficiency from the Federal Standard

Equipment Type	Sub Category	Draw Pattern	Federal Standard – Uniform Energy Factor ¹¹⁰⁷
Residential Gas Storage Water Heaters ≤75,000 Btu/h	≤55 gallon tanks	Very small	UEF = 0.3456 – (0.0020 * Rated Storage Volume in Gallons)
		Low	UEF = 0.5982 – (0.0019 * Rated Storage Volume in Gallons)
		Medium	UEF = 0.6483 – (0.0017 * Rated Storage Volume in Gallons)
		High	UEF = 0.6920 – (0.0013 * Rated Storage Volume in Gallons)
	>55 gallon and ≤100 gallon tanks	Very small	UEF = 0.6470 – (0.0006 * Rated Storage Volume in Gallons)
		Low	UEF = 0.7689 – (0.0005 * Rated Storage Volume in Gallons)
		Medium	UEF = 0.7897 – (0.0004 * Rated Storage Volume in Gallons)
		High	UEF = 0.8072 – (0.0003 * Rated Storage Volume in Gallons)

¹¹⁰⁴ DOE, Circulator Pump Technical Support Document, 2022 (2016-BT-STD-0004-0121). Circulator Pump Breakdowns by Nominal Horsepower and Sector for each Application. It was determined that 95 percent of hot water recirculation pumps are 1/12 hp or less.

¹¹⁰⁵ DOE, Circulator Pump Technical Support Document, 2022 (2016-BT-STD-0004-0121)DOE

¹¹⁰⁶ Fractional horsepower motors that are 1/12 hp or greater and less than 1 hp are not covered under NEMA design standards must have a minimum motor efficiency of 70 percent when rated in accordance with DOE 10 CFR 431.

¹¹⁰⁷ All Residential sized Federal Standards are from DOE Standard 10 CFR 430, Residential-Duty and Commercial Federal Standard are from DOE Standard 10 CFR 431.

Equipment Type	Sub Category	Draw Pattern	Federal Standard – Uniform Energy Factor ¹¹⁰⁷
Residential-duty Commercial High Capacity Storage Gas-Fired Storage Water Heaters > 75,000 Btu/h	≤120 gallon tanks	Very small	UEF = 0.2674 – (0.0009 * Rated Storage Volume in Gallons)
		Low	UEF = 0.5362 – (0.0012 * Rated Storage Volume in Gallons)
		Medium	UEF = 0.6002 – (0.0011 * Rated Storage Volume in Gallons)
		High	UEF = 0.6597 – (0.0009 * Rated Storage Volume in Gallons)
Commercial Gas Storage Water Heaters >75,000 Btu/h and ≤155,000 Btu/h	>120 gallon tanks	All	80% E _{thermal} , Standby Losses = (Q /800 + 110vRated Storage Volume in Gallons)
Commercial Gas Storage Water Heaters >155,000 Btu/h			
Residential Gas Instantaneous Water Heaters ≤ 200,000 Btu/h	≤2 gal	Very low	UEF = 0.80
		All other	UEF = 0.81
Commercial Gas Instantaneous Water Heaters > 200,000 Btu/h	<10 gal	All	80% E _{thermal}
	≥10 gal	All	78% E _{thermal}

Draw patterns are based on first hour rating (gallons) for storage tanks and maximum flow (GPM) for instantaneous as shown below:¹¹⁰⁸

Storage Water Heater Draw Pattern	
Draw Pattern	First Hour Rating (gallons)
Very Small	≥ 0 and < 18
Low	≥ 18 and < 51
Medium	≥ 51 and < 75
High	≥ 75

Instantaneous Water Heater Draw Pattern	
Draw Pattern	Max GPM
Very Small	≥ 0 and < 1.7
Low	≥ 1.7 and < 2.8
Medium	≥ 2.8 and < 4

SF = Savings factor based on Building type

Building Type	Savings Factor ¹¹⁰⁹
Single-Family - Deemed	9%
Multifamily - Deemed	9%

¹¹⁰⁸ Definitions provided in 10 CFR 430, Subpart B, Appendix E, Section 5.4.1.

¹¹⁰⁹ The savings factor from ACEEE Hot Water Forum. Control Methods, Code Requirements and Energy Savings. 9% is assumed to be the savings factor for multifamily and Single-Family buildings.

WATER AND OTHER NON-ENERGY IMPACT DESCRIPTIONS AND CALCULATION

N/A

DEEMED O&M COST ADJUSTMENT CALCULATION

N/A

MEASURE CODE: RS-HWE-CDHW-V02-250101

REVIEW DEADLINE: 1/1/2028

5.4.13 Auto-Diverting Tub Spout System

DESCRIPTION

This measure consists of replacing existing tub spouts and showerheads with an automatically diverting tub spout and showerhead system with a thermostatic restrictor shower valve between the existing shower arm and showerhead. When the water temperature reaches a set point (generally 95°F), the thermostatic restrictor valve will engage the anti-leak diverter. The water will divert to a showerhead with a normally closed valve that will prevent the hot water from going down the drain prior to the user entering the shower, thereby eliminating behavioral waste and tub spout leakage waste.

This measure was developed to be applicable to the following program types: RF, NC, DI, KITS. If applied to other program types, the measure savings should be verified.

DEFINITION OF EFFICIENT EQUIPMENT

To qualify for this measure, the installed equipment must be anti-leak, automatically diverting tub spout system with thermostatic restrictor technology installed on a residential shower arm and showerhead with a standard or low-flow showerhead.

DEFINITION OF BASELINE EQUIPMENT

The baseline condition is a residential tub spout with standard diverter, no thermostatic restrictor valve, and a standard showerhead rated at 2.0 GPM or greater.

DEEMED LIFETIME OF EFFICIENT EQUIPMENT

The expected measure life is assumed to be 10 years.¹¹¹⁰

DEEMED MEASURE COST

For the full tub spout with TSV and showerhead, the incremental cost of the measure should be the actual program cost (including labor if applicable), or \$117.66¹¹¹¹ plus \$40¹¹¹² labor if applicable.

If just the tub spout is installed (i.e., reuse existing showerhead), the incremental cost of the measure is \$66.90 plus \$20¹¹¹³ labor.

LOADSHAPE

Loadshape R03 - Residential Electric DHW

COINCIDENCE FACTOR

The coincidence factor for this measure is assumed to be 1.69%¹¹¹⁴

¹¹¹⁰ Measure life is assumed to be consistent with 5.4.5 Low Flow Showerheads.

¹¹¹¹ Average cost from online research at Lowes.com, HomeDepot.com, and Menards.com on 5/2/2024.

¹¹¹² Estimate for contractor installation time. Based on 2X cost for thermostatic restrictor shower valve installation in TRM 5.4.8 (1X for showerhead / TSV install, 1X for tub spout).

¹¹¹³ Estimate for contractor installation time. Based on cost for thermostatic restrictor shower valve installation in TRM 5.4.8.

¹¹¹⁴ Calculated as follows: Assume 11% showers take place during peak hours (based on: Oreo et al, "The end uses of hot water in single family homes from flow trace analysis", 2001.). There are 65 days in the summer peak period, so the percentage of total annual use in peak period is $0.11 * 65 / 365 = 1.96\%$. The number of hours of recovery during peak periods is therefore assumed to be $1.96\% * 223.7 = 4.38$ hours of recovery during peak period, where 223.7 equals the average annual electric DHW recovery hours for showerhead use. There are 260 hours in the peak period so the probability you will see savings during the peak period is $4.38 / 260 = 0.0169$

Algorithm

CALCULATION OF ENERGY SAVINGS

ELECTRIC ENERGY SAVINGS

$$\begin{aligned} \Delta\text{Water (gallons)} &= \text{Showerhead Behavioral Waste} + \text{Tub Spout Behavioral Waste} \\ &\quad + \text{Diverter Waste} + \text{Low Flow Showerhead Savings} \\ \text{Showerhead Behavioral Waste} &= \%WUE_{SH} * \text{GPM}_{base} * L_{showerdevice} * \text{SPCD} * 365.25 * \\ &\quad \text{Household} / \text{SPH} \\ \text{Tub Spout Behavioral Waste} &= \%WUE_{TS} * \text{GPM}_{spout} * L_{showerdevice} * \text{SPCD} * 365.25 * \\ &\quad \text{Household} / \text{SPH} \\ \text{Diverter Waste} &= \text{DLR} * L_{base} * \text{SPCD} * 365.25 * \text{Household} / \text{SPH} \\ \text{Low Flow Showerhead Savings} &= (\text{GPM}_{base} * L_{base} - \text{GPM}_{low} * L_{low}) * \text{SPCD} * 365.25 * \\ &\quad \text{Household} / \text{SPH} \end{aligned}$$

$$\Delta\text{kWh} = \%ElectricDHW * \Delta\text{Water (gallons)} * \text{EPG}_{electric} * \text{ISR}$$

Where:

$$\begin{aligned} \%WUE_{SH} &= \% \text{ of warm up events for showerhead} \\ &= 60\%^{1115} \end{aligned}$$

$$\begin{aligned} \%WUE_{TS} &= \% \text{ of warm up events for tub spout} \\ &= 40\%^{1116} \end{aligned}$$

$$\begin{aligned} \text{GPM}_{spout} &= \text{Flow rate of the tub spout} \\ &= 5.0 \text{ GPM}^{1117} \end{aligned}$$

$$\text{GPM}_{base} = \text{Flow rate of the basecase showerhead, or actual if available}$$

Program	GPM
Direct-install, device only	2.24 ¹¹¹⁸
New Construction or direct install of device and low flow showerhead	Rated or actual flow of program-installed showerhead
Retrofit or TOS	2.35 ¹¹¹⁹

$$\text{GPM}_{low} = \text{As-used flow rate of the low-flow showerhead, which may, as a result of measurements of program evaluations deviate from rated flows, see table below}^{1120}.$$

¹¹¹⁵ Arkansas Technical Reference Manual, Version 9.1, pg. 162. <https://apsc.arkansas.gov/programs-initiatives-activities/energy-efficiency/>

¹¹¹⁶ Ibid.

¹¹¹⁷ Ibid.

¹¹¹⁸ Based on measurements conducted from June 2013 to January 2014 by Franklin Energy. Over 300 residential sites in the Chicago area were tested.

¹¹¹⁹ Representative value from sources 1, 2, 4, 5, 6 and 7 (See Source Table at end of measure section) adjusted slightly upward to account for program participation which is expected to target customers with existing higher flow devices rather than those with existing low flow devices.

¹¹²⁰ Note that actual values may be either a) program-specific minimum flow rate, or b) program-specific evaluation-based

L_showerdevice = Hot water waste time avoided due to thermostatic restrictor valve
 = 0.89 minutes¹¹²¹

SPCD = Showers Per Capita Per Day
 = 0.6¹¹²²

365.25 = Days per year, on average

Household = Average number of people per household

Household Unit Type	Household ¹¹²³		
	IQ Participants	Non-IQ Participants	All Participants
Single-Family - Deemed	2.76	2.62	2.67
Multifamily - Deemed	2.3	2.09	2.18
Household type unknown			2.52 ¹¹²⁴
Custom	Actual Occupancy or Number of Bedrooms ¹¹²⁵		

Use Multifamily if: Building meets utility’s definition for multifamily

SPH = Showerheads Per Household so that per-showerhead savings fractions can be Determined

Household Type	SPH
Single-Family	1.79 ¹¹²⁶
Multifamily	1.3 ¹¹²⁷
Household type unknown	1.64 ¹¹²⁸
Custom	Actual

Use Multifamily if: Building meets utility’s definition for multifamily

DLR = Diverter leakage rate, gallons per minute
 = 0.8 GPM¹¹²⁹

L_base = Shower length in minutes with baseline showerhead

value of actual effective flow-rate due to increased duration or temperatures. The latter increases in likelihood as the rated flow drops and may become significant at or below rated flows of 1.5 GPM. The impact can be viewed as the inverse of the throttling described in the footnote for baseline flowrate.

¹¹²¹ Average of the following sources: ShowerStart LLC survey; “Identifying, Quantifying and Reducing Behavioral Waste in the Shower: Exploring the Savings Potential of ShowerStart”, City of San Diego Water Department survey; “Water Conservation Program: ShowerStart Pilot Project White Paper”, and PG&E Work Paper PGECODHW113.

¹¹²² Cadmus and Opinion Dynamics Showerhead and Faucet Aerator Meter Study Memorandum dated June 2013, directed to Michigan Evaluation Working Group.

¹¹²³ Assumptions are taken from the draft unadjusted 2024 Baseline Study evaluation data provided in 07/2024 by GDS Associates.

¹¹²⁴ Unknown is based on statewide weighted average of 69% single family and 31% multifamily, based on IL data from 2009 RECS Table HC2.9 Structural and Geographic Characteristics of Homes in Midwest Region, Divisions and States, 2009.

¹¹²⁵ Bedrooms are suitable proxies for household occupancy, and may be preferable to actual occupancy due to turnover rates in residency and non-adult population impacts.

¹¹²⁶ Based on findings from a 2009 ComEd residential survey of 140 sites, provided by Cadmus.

¹¹²⁷ Ibid.

¹¹²⁸ Unknown is based on statewide weighted average of 69% single family and 31% multifamily, based on IL data from 2009 RECS Table HC2.9 Structural and Geographic Characteristics of Homes in Midwest Region, Divisions and States, 2009.

¹¹²⁹ Arkansas Technical Reference Manual, Version 9.1, pg. 162. <https://apsc.arkansas.gov/programs-initiatives-activities/energy-efficiency/>

- = 7.8 minutes¹¹³⁰
- L_low = Shower length in minutes with low-flow showerhead
= 7.8 minutes¹¹³¹
- %ElectricDHW = Percentage of DHW savings assumed to be electric
= 100% for Electric
= 0% for Fossil Fuel
= If unknown¹¹³², use the following table:

Utility	Location				
	Single Family	Single Family Low Income	Multi Family	Multi Family Low Income	Unknown
Ameren ¹¹³³	24%	25%	40%	43%	28%
ComEd ¹¹³⁴	8%		11%		9%
People’s Gas ¹¹³⁵	2.0%	2.0%	1.7%	2.1%	2.0%
Northshore Gas ¹¹³⁶	1.3%	1.8%	10.0%	2.4%	2.3%
Nicor Gas ¹¹³⁷	1.3%	1.8%	10.0%	2.4%	2.3%
All DUs¹¹³⁸					25%

Note: If a measure is supported by a gas and electric utility through a joint program, and it is unknown whether the participant has a gas supply, the electric utility values in the table above should be used. If it is known that the participant has a gas supply, the values from the gas utility above should be applied.

- EPG_electric = Energy per gallon of hot water supplied by electric
= $(8.33 * 1.0 * (\text{ShowerTemp} - \text{SupplyTemp})) / (\text{RE_electric} * 3,412)$
= $(8.33 * 1.0 * (101 - 50.7)) / (0.98 * 3,412)$
= 0.125 kWh/gal
- 8.33 = Specific weight of water (lbs/gallon)
- 1.0 = Heat Capacity of water (btu/lb-°)
- ShowerTemp = Assumed temperature of water

¹¹³⁰ Cadmus and Opinion Dynamics Showerhead and Faucet Aerator Meter Study Memorandum dated June 2013, directed to Michigan Evaluation Working Group. This study of 135 single and Multifamily homes in Michigan metered energy parameters for efficient showerhead and faucet aerators.

¹¹³¹ Ibid.

¹¹³² Based on the average % electricity used for water heating in Unknown residential structure types across all utilities covered by the IL program. Residence types include: SF, SF LI, MF & MF LI. Utilities included: Ameren, ComEd, People’s Gas, Northshore Gas & Nicor. Please see subsequent table and citations for specific sources.

¹¹³³ Provided by AEG from the 2020 Market Potential Study completed for AIC, as well as AIC Income Qualified Initiative: 2021 Participant Survey Results Memo (February 1, 2022) p. 17.

¹¹³⁴ Commonwealth Edison Residential Baseline Study (2020). p.4.4 & 4.19; Section 4-7 Water Heating. Prepared by Itron.

¹¹³⁵ Implementation Contractors data from Peoples Gas and North Shore Gas for PY2022-2023.

¹¹³⁶ Ibid.

¹¹³⁷ Comparable service area & customers to NSG, therefore using their survey data.

¹¹³⁸ For the weighted average calculations, please see the Analysis file. PGL, NSG, Nicor & gas customers were assumed to follow the provided split. ComEd total customers, minus overlap with PGL,NSG & Nicor, therefore electric only homes. Ameren is total customers minus Nicor.

- = 101°F ¹¹³⁹
- SupplyTemp = Assumed temperature of water entering house
= 50.7°F ¹¹⁴⁰
- RE_electric = Recovery efficiency of electric water heater
= 98% ¹¹⁴¹
- 3412 = Converts Btu to kWh (btu/kWh)
- ISR = In service rate

Selection	ISR
Direct Install - Single Family	0.98 ¹¹⁴²
Direct Install – Multi Family	0.95 ¹¹⁴³
Efficiency Kits	To be determined through evaluation

Use Multifamily if: Building meets utility’s definition for multifamily

Secondary kWh Savings for Water Supply and Wastewater Treatment

The following savings should be included in the total savings for this measure, but should not be included in TRC tests to avoid double counting the economic benefit of water savings.

$$\Delta kWh_{water} = \Delta Water \text{ (gallons)} / 1,000,000 * E_{water \text{ total}}$$

Where

- E_{water total} = IL Total Water Energy Factor (kWh/Million Gallons)
= 5,010¹¹⁴⁴

SUMMER COINCIDENT PEAK DEMAND SAVINGS

$$\Delta kW = \Delta kWh/Hours * CF$$

Where:

- ΔkWh = calculated value above. Note do not include the secondary savings in this calculation.
- Hours = Annual electric DHW recovery hours for showerhead use
= ((GPM_base * L_base) * Household * SPCD * 365.25) * 0.726¹¹⁴⁵ / GPH
- GPH = Gallons per hour recovery of electric water heater calculated for 69.3°F temp rise (120-50.7),

¹¹³⁹ Cadmus and Opinion Dynamics Showerhead and Faucet Aerator Meter Study Memorandum dated June 2013, directed to Michigan Evaluation Working Group.
¹¹⁴⁰ Table 4 in Chen, et. al., “Calculating Average Hot Water Mixes of Residential Plumbing Fixtures”, June 2020, reports a value of 50.7°F for inlet water temperature for U.S. Census Division 3.
¹¹⁴¹ Electric water heaters have recovery efficiency of 98%.
¹¹⁴² Deemed values are from ComEd Energy Efficiency/ Demand Response Plan: Plan Year 2 (6/1/2009-5/31/2010) Evaluation Report: All Electric Single Family Home Energy Performance Tune-Up Program Table 3-8. Alternative ISRs may be developed for program delivery methods based on evaluation results.
¹¹⁴³ Navigant, ComEd-Nicor Gas EPY4/GPY1 Multifamily Home Energy Savings Program Evaluation Report FINAL 2013-06-05
¹¹⁴⁴ This factor includes 2571 kWh/MG for water supply based on Illinois energy intensity data from a 2012 ISAWWA study and 2439 kWh/MG for wastewater treatment based on national energy intensity use estimates. For more information please review Elevate Energy’s ‘IL TRM: Energy per Gallon Factor, May 2018 paper’.
¹¹⁴⁵ 72.6% is the proportion of hot 120F water mixed with 50.7F supply water to give 101F shower water.

98% recovery efficiency, and typical 4.5kW electric resistance storage tank.

= 26.1

CF = Coincidence Factor for electric load reduction

= 1.69%¹¹⁴⁶

FOSSIL FUEL SAVINGS

Δ Therms = %FossilDHW * Gallons Saved * EPG_gas * ISR

Where:

%FossilDHW = Percentage of DHW savings assumed to be fossil fuel

= 100% for Fossil Fuel

= 0% for Electric

= If unknown¹¹⁴⁷, use the following table:

Utility	Location				Unknown
	Single Family	Single Family Low Income	Multi Family	Multi Family Low Income	
Ameren ¹¹⁴⁸	76%	75%	60%	57%	72%
ComEd ¹¹⁴⁹	92%		89%		91%
People’s Gas ¹¹⁵⁰	97.9%	98.0%	98.3%	97.6%	97.8%
Northshore Gas ¹¹⁵¹	98.5%	98.2%	90.0%	97.6%	97.6%
Nicor Gas ¹¹⁵²	98.5%	98.2%	90.0%	97.6%	97.6%
All DUs¹¹⁵³					75%

Note: If a measure is supported by a gas and electric utility through a joint program, and it is unknown whether the participant has a gas supply, the electric utility values in the table above should be used. If it is known that the participant has a gas supply, the values from the gas utility above should be applied.

EPG_gas = Energy per gallon of Hot water supplied by gas

¹¹⁴⁶ Calculated as follows: Assume 11% showers take place during peak hours (based on: Oreo et al, “The end uses of hot water in single family homes from flow trace analysis”, 2001.). There are 65 days in the summer peak period, so the percentage of total annual use in peak period is 0.11*65/365 = 1.96%. The number of hours of recovery during peak periods is therefore assumed to be 1.96% * 223.7 = 4.38 hours of recovery during peak period, where 223.7 equals the average annual electric DHW recovery hours for showerhead use. There are 260 hours in the peak period so the probability you will see savings during the peak period is 4.38/260 = 0.0169

¹¹⁴⁷ Based on the average % electricity used for water heating in Unknown residential structure types across all utilities covered by the IL program. Residence types include: SF, SF LI, MF & MF LI. Utilities included: Ameren, ComEd, People’s Gas, Northshore Gas & Nicor. Please see subsequent table and citations for specific sources.

¹¹⁴⁸ Provided by AEG from the 2020 Market Potential Study completed for AIC, as well as AIC Income Qualified Initiative: 2021 Participant Survey Results Memo (February 1, 2022) p. 17.

¹¹⁴⁹ Commonwealth Edison Residential Baseline Study (2020). p.4.4 & 4.19; Section 4-7 Water Heating. Prepared by Itron.

¹¹⁵⁰ Residential Appliance Saturation Survey of natural gas for space heating and water heating (2021). Note, Multifamily customers have a residential billing rate code and responded on the survey that they live in an apartment or condominium in a building that has either 2-4 or 5+ units.

¹¹⁵¹ Ibid.

¹¹⁵² Comparable service area & customers to NSG, therefore using their survey data.

¹¹⁵³ For the weighted average calculations, please see the Analysis file. PGL, NSG, Nicor & gas customers were assumed to follow the provided split. ComEd total customers, minus overlap with PGL,NSG & Nicor, therefore gas only homes. Ameren is total customers minus Nicor.

$$= (8.33 * 1.0 * (\text{ShowerTemp} - \text{SupplyTemp})) / (\text{RE_gas} * 100,000)$$

= 0.0054 Therm/gal for SF homes

= 0.0063 Therm/gal for MF homes

RE_gas = Recovery efficiency of gas water heater

= 78% For individual water heater¹¹⁵⁴

= 67% For shared water heater¹¹⁵⁵

If unknown, use individual water heater value for single family, use shared water heater value for multifamily. Use multifamily if building meets utility’s definition for multifamily.

100,000 = Converts Btus to Therms (btu/Therm)

Other variables as defined above.

WATER AND OTHER NON-ENERGY IMPACT DESCRIPTIONS AND CALCULATION

Calculation provided together with Electric Energy Savings above.

DEEMED O&M COST ADJUSTMENT CALCULATION

N/A

SOURCES

Source ID	Reference
1	2011, DeOreo, William. California Single Family Water Use Efficiency Study. April 20, 2011.
2	2000, Mayer, Peter, William DeOreo, and David Lewis. Seattle Home Water Conservation Study. December 2000.
3	1999, Mayer, Peter, William DeOreo. Residential End Uses of Water. Published by AWWA Research Foundation and American Water Works Association. 1999.
4	2003, Mayer, Peter, William DeOreo. Residential Indoor Water Conservation Study. Aquacraft, Inc. Water Engineering and Management. Prepared for East Bay Municipal Utility District and the US EPA. July 2003.
5	2011, DeOreo, William. Analysis of Water Use in New Single Family Homes. By Aquacraft. For Salt Lake City Corporation and US EPA. July 20, 2011.
6	2011, Aquacraft. Albuquerque Single Family Water Use Efficiency and Retrofit Study. For Albuquerque Bernalillo County Water Utility Authority. December 1, 2011.
7	2008, Schultdt, Marc, and Debra Tachibana. Energy related Water Fixture Measurements: Securing the Baseline for Northwest Single Family Homes. 2008 ACEEE Summer Study on Energy Efficiency in Buildings.

¹¹⁵⁴ DOE Final Rule discusses Recovery Efficiency with an average around 0.76 for Gas Fired Storage Water heaters and 0.78 for standard efficiency gas fired tankless water heaters up to 0.95 for the highest efficiency gas fired condensing tankless water heaters. These numbers represent the range of new units however, not the range of existing units in stock. Review of AHRI Directory suggests range of recovery efficiency ratings for new Gas DHW units of 70-87%. Average of existing units is estimated at 78%.

¹¹⁵⁵ Water heating in Multifamily buildings is often provided by a larger central boiler. This suggests that the average recovery efficiency is somewhere between a typical central boiler efficiency of 0.59 and the 0.75 for single family homes. An average efficiency of 0.67 is used for this analysis as a default for Multifamily buildings.

MEASURE CODE: RS-HWE-ADTS-V01-250101

REVIEW DEADLINE: 1/1/2029

5.5 Lighting End Use

- 5.5.1 Compact Fluorescent Lamp (CFL)—Retired 12/31/2018, Removed in v8
- 5.5.2 ENERGY STAR Specialty Compact Fluorescent Lamp (CFL)—Retired 12/31/2018, Removed in v8
- 5.5.3 ENERGY STAR Torchiere—Retired 12/31/2018, Removed in v8
- 5.5.4 Exterior Hardwired Compact Fluorescent Lamp (CFL) Fixture—Retired 12/31/2018, Removed in v8
- 5.5.5 Interior Hardwired Compact Fluorescent Lamp (CFL) Fixture—Retired 12/31/2018, Removed in v8

5.5.6 LED Specialty Lamps

DESCRIPTION

Please note that this measure characterization contains specific assumptions that were negotiated as a compromise between the utilities and stakeholders and also reflects input from community-based organizations. The compromise is designed to allow for a gradual change in Income Qualified programming and to address the unique challenges that an abrupt change makes within the context of the Illinois CPAS savings goal structure. Such compromise shall not be taken as precedent for future non-consensus discussions.

This measure describes savings from a variety of specialty LED lamp types (including globe, decorative and downlights). This characterization assumes that the LED lamp is installed in a residential location. For stores easily accessed by income qualified communities, 100% of sales are assumed to be Income Qualified (IQ) residential.

This measure was developed to be applicable to the following program types: TOS, NC, EREP, KITS.

If applied to other program types, the measure savings should be verified.

DEFINITION OF EFFICIENT EQUIPMENT

To qualify for this measure the installed equipment must be an ENERGY STAR LED lamp or fixture or equivalent to the most recent version of ENERGY STAR specifications. Note a new ENERGY STAR specification v2.1 becomes effective on 1/2/2017.

DEFINITION OF BASELINE EQUIPMENT

Specialty and Directional lamps were not included in the original definition of General Service Lamps in the Energy Independence and Security Act of 2007 (EISA). Therefore, the initial baseline is an incandescent / halogen lamp described in the table below.

A DOE Final Rule released on 1/19/2017 updated the EISA regulations to remove the exemption for these lamp types such that they become subject to the backstop provision defined within the original legislation. In September 2019 this decision was revoked in a new DOE Final Rule. However, in May 2022 DOE reversed this decision by issuing a Final rule for both the broadened General Service Lamp definition as well as the implementation of the 45 lumen per watt backstop. DOE stated that it will use its enforcement discretion to minimize impacts on the supply chain and effectively allow companies to continue the manufacture and import of noncompliant bulbs through the remainder of 2022, and allow retailers to continue selling them with limited enforcement until July 2023.

As of 6/30/2023, no savings are claimed for non-income qualified programs unless via direct install programs. Direct Install programs where it can be shown that the LED is replacing working inefficient lighting should continue to use the existing inefficient lighting as baseline and also assume a measure life of 2 years.

Income Qualified Programs

Through 2025, Retail programs in stores ‘easily accessed by income qualified communities’ (as defined below), and Kit, School and Foodbank programs, will continue to assume a halogen baseline and apply a measure life of 8 years.

A store is considered easily accessed by income qualified communities¹¹⁵⁶:

- a. For Ameren:
 - i. if it is a retail store that is closest to a community with a zip code that has 65% of family households with an income less than or equal to 299% of the Federal poverty level for their household size (Applies to big box (e.g., Walmart), club (e.g., Costco), DIY (e.g., Home Depot), hardware and grocery stores); or
 - ii. If it is a "dollar store" in the AIC service area; or

¹¹⁵⁶ Utilities to provide list of all stores that are easily accessed by income qualified communities, as defined above, by December 31, 2022, with one of the utility's quarterly reports and to the utility's independent evaluator. The Utilities will update the list of stores annually, by December 31 of each year of the current portfolio cycle in a similar fashion.

- iii. If it is a "thrift store" in the AIC service area.
- b. For ComEd:
 - i. if it is a retail store is within a zip code where at least 60% or more of the households are at or below 80% Area Median Income (AMI); or
 - ii. If it is a "dollar store" in the ComEd service area; or
 - iii. If it is a "thrift store" in the ComEd service area.

100% of sales from such stores as defined above will count as IQ lighting.

Direct Install programs where it can be shown that the LED is replacing working inefficient lighting should continue to use the existing inefficient lighting as baseline and also assume a measure life of 8 years.

DEEMED LIFETIME OF EFFICIENT EQUIPMENT

The average rated life for Decorative lamps on the ENERGY STAR Qualified Products list (accessed 6/16/2020) is approximately 17,000 hours, and for Directional Lamps is approximately 25,000 hours.

However, for all purchases through 2025 the measure life is assumed to be two years for Direct Install in non-income eligible populations and eight years for income eligible populations.

DEEMED MEASURE COST

The price of LED lamps is falling quickly. Where possible, the actual cost should be used and compared to the baseline cost provided below. If the incremental cost is unknown, assume the following:¹¹⁵⁷

Bulb Type	Year	Incandescent	LED	Incremental Cost
Directional	2019 and on	\$3.53	\$5.18	\$1.65
Decorative and Globe	2019 and on	\$1.74	\$3.40	\$1.66

LOADSHAPE

Loadshape R06 - Residential Indoor Lighting

Loadshape R07 - Residential Outdoor Lighting

COINCIDENCE FACTOR

The summer peak coincidence factor is assumed to be 0.109 for residential and in-unit multifamily bulbs,¹¹⁵⁸ 0.273 for exterior bulbs¹¹⁵⁹ and 0.117 for unknown¹¹⁶⁰. Use Multifamily if the building meets the utility’s definition for multifamily.

Algorithm

¹¹⁵⁷ Baseline and LED lamp costs for both directional and decorative and globe are based on field data collected by CLEAResult and provided by ComEd. See ComEd Pricing Projections 06302016.xlsx for analysis.

¹¹⁵⁸ Based on the IL Statewide LED Lighting Logger study conducted as part of the PY8/PY9 evaluations of the Ameren Illinois and ComEd Residential Lighting programs.

¹¹⁵⁹ Based on lighting logger study conducted as part of the PY5/6 ComEd Residential Lighting Program evaluation. the IL Statewide LED Lighting Logger study conducted as part of the PY8/PY9 evaluations of the Ameren Illinois and ComEd Residential Lighting programs was unable to provide coincidence factors for specialty LEDs in exterior applications.

¹¹⁶⁰ Based on a weighted average of coincidence factors in interior and exterior applications, assuming 5% exterior lighting. The distribution of LEDs is based on the on-site lighting inventory conducted as part of the IL Statewide LED Lighting Logger study.

CALCULATION OF SAVINGS

ELECTRIC ENERGY SAVINGS

$$\Delta kWh = ((WattsBase - WattsEE) / 1000) * ISR * (1 - Leakage) * Hours * WHFe$$

Where:

Watts_{base} = Input wattage of the existing or baseline system. Reference the table below for default values.¹¹⁶¹

Watts_{EE} = Actual wattage of LED purchased / installed. If unknown, use default provided below.

¹¹⁶¹ See file “LED Lamp Updates 2021-06-09” for details on Guidehouse lamp wattage calculations based on equivalent baseline wattage and LED wattage of available ENERGY STAR product.

Decorative Lamps – ENERGY STAR Minimum Luminous Efficacy = 65Lm/W for all lamps

Bulb Type	Minimum Lumens	Maximum Lumens	LED Wattage (Watts _{EE})	Baseline (Watts _{Base})	Delta Watts (Watts _{EE})
Omni-Directional 3-Way	1,100	1,999	14.7	100	85.3
	2,000	2,700	22.6	150	127.4
Globe (medium and intermediate bases less than 750 lumens)	310	349	3.0	25	22
	350	499	4.7	40	35.3
	500	574	5.7	60	54.3
	575	649	6.5	75	68.5
	650	1,000	8.2	100	91.8
Globe (candelabra bases less than 1050 lumens)	310	349	3.5	25	21.5
	350	499	4.4	40	35.6
	500	574	5.5	60	54.5
Decorative (Shapes B, BA, C, CA, DC, F, G, medium and intermediate bases less than 750 lumens)	310	499	4.3	40	35.7
	500	800	5.8	60	54.2
Decorative (Shapes B, BA, C, CA, DC, F, G, candelabra bases less than 1050 lumens)	310	499	4.2	40	35.8
	500	650	5.5	60	54.5
Decorative (Shape ST)	310	499	6.5	40	33.5
	500	999	8.8	60	51.2
	1000	1500	10.0	100	90.0
Decorative (Shape S)	310	340	2.25	25	22.8

Directional Lamps - ENERGY STAR Minimum Luminous Efficacy = 70Lm/W for <90 CRI lamps and 61 Lm/W for >=90CRI lamps.

For Directional R, BR, and ER lamp types:¹¹⁶²

¹¹⁶² From pg. 13 of the ENERGY STAR Specification for lamps v2.1

Bulb Type	Minimum Lumens	Maximum Lumens	LED Wattage (Watts _{EE})	Baseline (Watts _{Base})	Delta Watts (Watts _{EE})
Reflector lamp types with medium screw bases (PAR20, PAR30(S,L), PAR38, R40, etc.) w/ diameter >2.25" (*see exceptions below)	400	649	7.0	50	43
	650	899	10.7	75	64.3
	900	1,049	13.9	90	76.1
	1,050	1,199	13.8	100	86.2
	1,200	1,499	15.9	120	104.1
	1,500	1,999	18.9	150	131.1
Reflector lamp types with medium screw bases (PAR16, R14, R16, etc.) w/ diameter <2.25" (*see exceptions below)	310	374	4.6	35	30.4
	375	600	6.4	50	43.6
*BR30, BR40, or ER40	650	949	9.3	65	55.7
	950	1,099	12.7	75	62.3
	1,100	1,399	14.4	85	70.6
	1,400	1,600	16.6	100	83.4
	1,601	1,800	22.2	120	97.8
*R20	450	524	6.0	40	34.0
	525	750	7.1	45	37.9
*MR16	310	324	3.8	20.0	16.2
	325	369	4.8	25.0	20.2
	370	400	4.9	25.0	20.1

For PAR, MR, and MRX Lamps Types:

For these highly focused directional lamp types, it is necessary to have Center Beam Candle Power (CBCP) and beam angle measurements to accurately estimate the equivalent baseline wattage. The formula below is based on the ENERGY STAR Center Beam Candle Power tool.¹¹⁶³ If CBCP and beam angle information are not available or if the equation below returns a negative value (or undefined), use the manufacturer’s recommended baseline wattage equivalent.¹¹⁶⁴

Wattsbase =

$$375.1 - 4.355(D) - \sqrt{227,800 - 937.9(D) - 0.9903(D^2) - 1479(BA) - 12.02(D * BA) + 14.69(BA^2) - 16,720 * \ln(CBCP)}$$

Where:

- D = Bulb diameter (e.g. for PAR20 D = 20)
- BA = Beam angle
- CBCP = Center beam candle power

¹¹⁶³ See ‘ESLampCenterBeamTool.xls’.

¹¹⁶⁴ The ENERGY STAR Center Beam Candle Power tool does not accurately model baseline wattages for lamps with certain bulb characteristic combinations – specifically for lamps with very high CBCP.

The result of the equation above should be rounded DOWN to the nearest wattage established by ENERGY STAR:

Diameter	Permitted Wattages
16	20, 35, 40, 45, 50, 60, 75
20	50
30S	40, 45, 50, 60, 75
30L	50, 75
38	40, 45, 50, 55, 60, 65, 75, 85, 90, 100, 120, 150, 250

Additional EISA non-exempt bulb types:

Bulb Type	Minimum Lumens	Maximum Lumens	LED Wattage (Watts _{EE})	Baseline (Watts _{Base})	Delta Watts (Watts _{EE})
Dimmable Twist, Globe (less than 5" in diameter and > 749 lumens), candle (shapes B, BA, CA > 749 lumens), Candelabra Base Lamps (>1049 lumens), Intermediate Base Lamps (>749 lumens)	310	399	4.0	25	21.0
	400	749	6.6	29	22.4
	750	899	9.6	43	33.4
	900	1,399	13.1	53	39.9
	1,400	1,999	16.0	72	56.0

ISR = In Service Rate or the percentage of lamps rebated that get installed

Program	In Service Rate (ISR) ¹¹⁶⁵
Retail (Time of Sale)	97.9% ¹¹⁶⁶
Direct Install	94.5% ¹¹⁶⁷

¹¹⁶⁵ In Service Rates now represent the lifetime In Service Rates with the second and third year installations discounted by the Real Discount Rate of 0.46%. Lifetime ISR assumptions for efficiency kits are based upon comparing with CFL Distribution First year ISR and multiplying by the CFL Distribution Final ISR value, capped at 95%, and second and third year estimates based on same proportion of future installs. For all other programs the 98% Lifetime ISR assumption is based upon the standard CFL measure in the absence of any better reference. This value is based upon review of two evaluations:

‘Nexus Market Research, RLW Analytics and GDS Associates study; ‘New England Residential Lighting Markdown Impact Evaluation, January 20, 2009’ and ‘KEMA Inc, Feb 2010, Final Evaluation Report:, Upstream Lighting Program, Volume 1.’ This implies that only 2% of bulbs purchased are never installed. The second and third year installations are based upon Ameren analysis of the Californian KEMA study showing that 54% of future installs occur in year 2 and 46% in year 3.

¹¹⁶⁶ 1st year in service rate is based upon analysis of ComEd PY8, PY9 and CY2018 intercept data (see ‘Res Lighting ISR_2019.xlsx’ for more information).

¹¹⁶⁷ Consistent with assumption for standard LEDs (in the absence of evidence that it should be different for this bulb type). Based upon average of Navigant low income single family direct install field work LED ISR and review of the PY2 and PY3 ComEd Direct Install program surveys. This value includes bulb failures in the 1st year to be consistent with the Commission approval of annualization of savings for first year savings claims. ComEd PY2 All Electric Single Family Home Energy Performance Tune-Up Program Evaluation, Navigant Consulting, December 21, 2010.

Program		In Service Rate (ISR) ¹¹⁶⁵
Virtual Assessment followed by Unverified Self-Install		97.9% ¹¹⁶⁸
Efficiency Kits ¹¹⁶⁹	LED Distribution ¹¹⁷⁰	82.8%
	School Kits ¹¹⁷¹	83.8%
	Direct Mail Kits ¹¹⁷²	91.8%
	Direct Mail Kits, Income Qualified ¹¹⁷³	64.8%
	Community Distributed Kits ¹¹⁷⁴	95.0%

Leakage = Adjustment to account for the percentage of program bulbs that move out (and in if deemed appropriate)¹¹⁷⁵ of the Utility Jurisdiction.

KITS programs = Determined through evaluation

Upstream (TOS) Lighting programs = Use deemed assumptions below:¹¹⁷⁶

ComEd: 1.1%

Ameren: 13.1%

All other programs = 0

Hours = Average hours of use per year

Installation Location	Annual hours of use (HOU)
Residential and In-Unit Multi Family	763 ¹¹⁷⁷

¹¹⁶⁸ An equal weighted average of Direct Install and Direct Mail Kit ISRs. Interest and applicability of measures confirmed through virtual assessment.

¹¹⁶⁹ In Service Rates provided are for the bulb within a kit only. Given the significant differences in program design and the level of education provided through Efficiency Kits programs, the evaluators should apply the ISR estimated through evaluations (either past evaluations or the current program year evaluation) of the specific Efficiency Kits program. In cases where program-specific evaluation results for an ISR are unavailable, the default ISR values for Efficiency Kits provide may be used.

¹¹⁷⁰ Free bulbs provided without request, with little or no education. Consistent with Standard CFL assumptions.

¹¹⁷¹ 1st year ISR for school kits based on ComEd PY9 data for the Elementary Energy Education program. Final ISR assumptions are based upon comparing with CFL Distribution First year ISR and multiplying by the CFL Distribution Final ISR value, and second and third year estimates based on same proportion of future installs.

¹¹⁷² Opt-in program to receive kits via mail, with little or no education. Consistent with Standard CFL assumptions.

¹¹⁷³ Research from 2021 Ameren Illinois Income Qualified participant survey (customer self-report), available on IL SAG website: <https://ilsag.s3.amazonaws.com/AIC-Income-Qualified-Initiative-Participant-Survey-Results-Memo-FINAL-2022-02-01.pdf>

¹¹⁷⁴ Kits distributed in a community setting, targeted to income qualified communities. Research from 2018 Ameren Illinois Income Qualified participant survey.

¹¹⁷⁵ Leakage in is only appropriate to credit to IL utility program savings if it is reasonably expected that the IL utility program marketing efforts played an important role in influencing customer to purchase the light bulbs. Furthermore, consideration that such customers might be free riders should be addressed. If leakage in is assessed, efforts should be made to ensure no double counting of savings occurs if the evaluation is estimating both leakage in and spillover savings of light bulbs.

¹¹⁷⁶ Leakage rate is based upon review of PY8-CY2018 evaluations from ComEd and PY5,6 and 8 for Ameren.

¹¹⁷⁷ Based on the IL Statewide LED Lighting Logger study evaluations conducted as part of the PY8/PY9 evaluations of the Ameren Illinois and ComEd Residential Lighting programs.

Installation Location	Annual hours of use (HOU)
Exterior	2,475 ¹¹⁷⁸
Unknown	1,020 ¹¹⁷⁹

WHFe = Waste heat factor for energy to account for cooling savings from efficient lighting

Bulb Location	WHFe
Interior single family	1.06 ¹¹⁸⁰
Multifamily in unit	1.04 ¹¹⁸¹
Exterior or uncooled location	1.0
Unknown location	1.046 ¹¹⁸²

Use Multifamily if: Building meets utility’s definition for multifamily

For example, a 13W PAR20 LED is purchased through a ComEd upstream program and installed in place of a 750 lumen PAR20 incandescent screw-in lamp with medium screw base, diameter >2.5" in a single family interior location:

$$\Delta kWh = ((75 - 13) / 1000) * 0.840 * (1 - 0.011) * 763 * 1.06$$

$$= 41.6 kWh$$

HEATING PENALTY

If electric heated home (if heating fuel is unknown assume gas, see Fossil Fuel section):

$$\Delta kWh^{1183} = - (((WattsBase - WattsEE) / 1000) * ISR * (1 - Leakage) * Hours * HF) / \eta_{Heat}$$

Where:

HF = Heating Factor or percentage of light savings that must be heated

¹¹⁷⁸ Based on lighting logger study conducted as part of the PY5/6 ComEd Residential Lighting Program evaluation. The IL Statewide LED Lighting Logger study conducted as part of the PY8/PY9 evaluations of the Ameren Illinois and ComEd Residential Lighting programs was unable to provide hours of use for specialty LEDs in exterior applications.

¹¹⁷⁹ Based on a weighted average of interior and exterior hours of use from the IL Statewide LED Lighting Logger study conducted as part of the PY8/PY9 evaluations of the Ameren Illinois and ComEd Residential Lighting programs, assuming 15% exterior specialty lighting. The distribution of LEDs is based on the on-site lighting inventory conducted as part of the IL Statewide LED Lighting Logger study.

¹¹⁸⁰ The value is estimated at 1.06 (calculated as 1 + (0.66*(0.27 / 2.8)). Based on cooling loads decreasing by 27% of the lighting savings (average result from REMRate modeling of several different configurations and IL locations of homes), assuming typical cooling system operating efficiency of 2.8 COP (starting from standard assumption of SEER 10.5 central AC unit, converted to 9.5 EER using algorithm (-0.02 * SEER2) + (1.12 * SEER) (from Wassmer, M. (2003). A Component-Based Model for Residential Air Conditioner and Heat Pump Energy Calculations. Masters Thesis, University of Colorado at Boulder), converted to COP = EER/3.412 = 2.8COP) and 66% of homes in Illinois having central cooling ("Table HC7.9 Air Conditioning in Homes in Midwest Region, Divisions, and States, 2009 from Energy Information Administration", 2009 Residential Energy Consumption Survey)

¹¹⁸¹ As above but using estimate of 45% of multifamily buildings in Illinois having central cooling (based on data from "Table HC7.1 Air Conditioning in U.S. Homes, By Housing Unit Type, 2009" which is for the whole of the US, scaled to IL air conditioning prevalence compared to US average)

¹¹⁸² Unknown is weighted average of interior v exterior (assuming 15% exterior specialty lighting based on distribution of LEDs from on-site lighting inventory conducted as part of the IL Statewide LED Lighting Logger study) and SF v MF interior based on statewide weighted average of 69% single family and 31% multifamily, based on IL data from 2009 RECS Table HC2.9 Structural and Geographic Characteristics of Homes in Midwest Region, Divisions and States, 2009.

¹¹⁸³ Negative value because this is an increase in heating consumption due to the efficient lighting.

- = 49% for interior location ¹¹⁸⁴
- = 0% for exterior location
- = 42% for unknown location ¹¹⁸⁵

η_{Heat} = Efficiency in COP of Heating equipment
 = Actual. If not available use: ¹¹⁸⁶

System Type	Age of Equipment	HSPF2 Estimate	COP _{HEAT} (COP Estimate) = (HSPF2/3.413)*0.85
Heat Pump (if age unknown assume 2006-2014)	Before 2006	5.8	1.44
	After 2006 - 2014	6.5	1.62
	2015 on	7.0	1.74
Resistance	N/A	N/A	1.00
Unknown ¹¹⁸⁷	N/A	N/A	1.28

For example, a 13W PAR20 LED is purchased through a ComEd upstream program and installed in place of a 750 lumen PAR20 incandescent screw-in lamp with medium screw base, diameter >2.5" in a single family interior location with a 2016 heat pump:

$$\Delta kWh = - ((75 - 13) / 1000) * 0.840 * (1 - 0.011) * 763 * 0.49 / 2.04$$

$$= - 9.4 kWh$$

SUMMER COINCIDENT PEAK DEMAND SAVINGS

$$\Delta kW = ((WattsBase - WattsEE) / 1000) * ISR * (1 - Leakage) * WHFd * CF$$

Where:

WHFd = Waste heat factor for demand to account for cooling savings from efficient lighting.

Bulb Location	WHFd
Interior single family	1.11 ¹¹⁸⁸
Multifamily in unit	1.07 ¹¹⁸⁹

¹¹⁸⁴ This means that heating loads increase by 49% of the lighting savings. This is based on the average result from REMRate modeling of several different configurations and IL locations of homes.

¹¹⁸⁵ Based on a weighted average of interior and exterior hours of use from the IL Statewide LED Lighting Logger study conducted as part of the PY8/PY9 evaluations of the Ameren Illinois and ComEd Residential Lighting programs, assuming 15% exterior specialty lighting. The distribution of LEDs is based on the on-site lighting inventory conducted as part of the IL Statewide LED Lighting Logger study.

¹¹⁸⁶ These default system efficiencies are based on the applicable minimum Federal Standards. In 2006 the Federal Standard for Heat Pumps was adjusted. While one would expect the average system efficiency to be higher than this minimum, the likely degradation of efficiencies over time mean that using the minimum standard is appropriate. Note efficiency should include duct losses. Defaults provided assume 15% duct loss for heat pumps.

¹¹⁸⁷ Calculation assumes 35% Heat Pump and 65% Resistance, which is based upon data from Energy Information Administration, 2009 Residential Energy Consumption Survey, see "HC6.9 Space Heating in Midwest Region.xls", using average for East North Central Region. Average efficiency of heat pump is based on assumption that 50% are units from before 2006 and 50% from 2006-2014. Program or evaluation data should be used to improve this assumption if available.

¹¹⁸⁸ The value is estimated at 1.11 (calculated as 1 + (0.66 * 0.466 / 2.8)). See footnote relating to WHFe for details. Note the 46.6% factor represents the average Residential cooling coincidence factor calculated by dividing average load during the peak hours divided by the maximum cooling load.

¹¹⁸⁹ As above but using estimate of 45% of multifamily buildings in Illinois having central cooling (based on data from "Table

Bulb Location	WHFd
Exterior or uncooled location	1.0
Unknown location	1.083 ¹¹⁹⁰

Use Multifamily if: Building meets utility’s definition for multifamily

- CF = Summer Peak Coincidence Factor for measure
 = 0.109 for residential and in-unit multifamily bulbs¹¹⁹¹, 0.273 for exterior bulbs,¹¹⁹² and 0.117 for unknown.¹¹⁹³
 Use Multifamily if: Building meets utility’s definition for multifamily
 Other factors as defined above

For example, a 13W PAR20 LED is purchased through a ComEd upstream program and installed in place of a 750 lumen PAR20 incandescent screw-in lamp with medium screw base, diameter >2.5" in a single family interior location:

$$\Delta kW = ((75 - 13) / 1000) * 0.840 * (1 - 0.011) * 1.11 * 0.109$$

$$= 0.0062 \text{ kW}$$

FOSSIL FUEL SAVINGS

Heating penalty if Natural Gas heated home, or if heating fuel is unknown.

$$\Delta \text{therms} = - (((\text{WattsBase} - \text{WattsEE}) / 1000) * \text{ISR} * (1 - \text{Leakage}) * \text{Hours} * \text{HF} * 0.03412) / \eta \text{Heat}$$

Where:

- HF = Heating factor, or percentage of lighting savings that must be replaced by heating system.
 = 49% for interior¹¹⁹⁴
 = 0% for exterior location
 = 42% for unknown location¹¹⁹⁵
- 0.03412 = Converts kWh to Therms
- ηHeat = Average heating system efficiency.

HC7.1 Air Conditioning in U.S. Homes, By Housing Unit Type, 2009” which is for the whole of the US, scaled to IL air conditioning prevalence compared to US average)

¹¹⁹⁰ Unknown is weighted average of interior v exterior (assuming 15% exterior specialty lighting based on distribution of LEDs from on-site lighting inventory conducted as part of the IL Statewide LED Lighting Logger study) and SF v MF interior based on statewide weighted average of 69% single family and 31% multifamily, based on IL data from 2009 RECS Table HC2.9 Structural and Geographic Characteristics of Homes in Midwest Region, Divisions and States, 2009.

¹¹⁹¹ Based on the IL Statewide LED Lighting Logger study conducted as part of the PY8/PY9 evaluations of the Ameren Illinois and ComEd Residential Lighting programs.

¹¹⁹² Based on lighting logger study conducted as part of the PY5/6 ComEd Residential Lighting Program evaluation. the IL Statewide LED Lighting Logger study conducted as part of the PY8/PY9 evaluations of the Ameren Illinois and ComEd Residential Lighting programs was unable to provide coincidence factors for specialty LEDs in exterior applications.

¹¹⁹³ Based on a weighted average of coincidence factors in interior and exterior applications, assuming 5% exterior lighting. The distribution of LEDs is based on the on-site lighting inventory conducted as part of the IL Statewide LED Lighting Logger study.

¹¹⁹⁴ Average result from REMRate modeling of several different configurations and IL locations of homes

¹¹⁹⁵ Based on a weighted average of interior and exterior hours of use from the IL Statewide LED Lighting Logger study conducted as part of the PY8/PY9 evaluations of the Ameren Illinois and ComEd Residential Lighting programs, assuming 15% exterior specialty lighting. The distribution of LEDs is based on the on-site lighting inventory conducted as part of the IL Statewide LED Lighting Logger study.

$$= 0.70^{1196}$$

Other factors as defined above

For example, a 13W PAR20 LED is purchased through a ComEd upstream program and installed in place of a 750 lumen PAR20 incandescent screw-in lamp with medium screw base, diameter >2.5" in single family interior location with gas heating at 70% total efficiency:

$$\begin{aligned} \Delta \text{therms} &= - ((75 - 13) / 1000) * 0.840 * (1 - 0.011) * 763 * 0.49 * 0.03412 / 0.70 \\ &= - 0.94 \text{ therms} \end{aligned}$$

WATER IMPACT DESCRIPTIONS AND CALCULATION

N/A

DEEMED O&M COST ADJUSTMENT CALCULATION

For income eligible populations, an annual baseline cost of \$1.74 for decorative and \$3.53 for directional should be applied.

It is important to note that for cost-effectiveness screening purposes, the O&M cost adjustments should only be applied in cases where the light bulbs area actually in service and so should be multiplied by the appropriate ISR.

MEASURE CODE: RS-LTG-LEDD-V17-240101

REVIEW DEADLINE: 1/1/2026

¹¹⁹⁶ This has been estimated assuming that natural gas central furnace heating is typical for Illinois residences (66% of Illinois homes have a Natural Gas Furnace (based on Energy Information Administration, 2009 Residential Energy Consumption Survey) In 2000, 24% of furnaces purchased in Illinois were condensing (based on data from GAMA, provided to Department of Energy during the federal standard setting process for residential heating equipment - see Furnace Penetration.xls). Furnaces tend to last up to 20 years and so units purchased 10 years ago provide a reasonable proxy for the current mix of furnaces in the State. Assuming typical efficiencies for condensing and non-condensing furnaces and duct losses, the average heating system efficiency is estimated as follows:

$$(0.24 * 0.92) + (0.76 * 0.8) * (1 - 0.15) = 0.70$$

5.5.7 LED Exit Signs

DESCRIPTION

This measure characterizes the savings associated with installing a Light Emitting Diode (LED) exit sign in place of a fluorescent or incandescent exit sign in a Multifamily building within unit (use 4.5.5 Commercial Exit Signs for multifamily common area exit signs). Light Emitting Diode exit signs have a string of very small, typically red or green, glowing LEDs arranged in a circle or oval. The LEDs may also be arranged in a line on the side, top or bottom of the exit sign. LED exit signs provide the best balance of safety, low maintenance, and very low energy usage compared to other exit sign technologies.

This measure was developed to be applicable to the following program types: RF.

If applied to other program types, the measure savings should be verified.

DEFINITION OF EFFICIENT EQUIPMENT

The efficient equipment is assumed to be an exit sign illuminated by LEDs.

DEFINITION OF BASELINE EQUIPMENT

The baseline equipment is assumed to be an existing fluorescent or incandescent model.

DEEMED LIFETIME OF EFFICIENT EQUIPMENT

The measure life is assumed to be 5 years.¹¹⁹⁷

DEEMED MEASURE COST

The actual material and labor costs should be used if available. If actual costs are unavailable, assume a total installed cost of at \$32.50.¹¹⁹⁸

LOADSHAPE

Loadshape C53 - Flat

COINCIDENCE FACTOR

The summer peak coincidence factor for this measure is assumed to be 100%.¹¹⁹⁹

Algorithm

CALCULATION OF SAVINGS

ELECTRIC ENERGY SAVINGS

$$\Delta kWh = ((Watts_{Base} - Watts_{EE}) / 1000) * HOURS * WHF_e$$

Where:

Watts_{Base} = Actual wattage if known, if unknown assume the following:

Baseline Type	Watts _{Base}
Incandescent	35W ¹²⁰⁰

¹¹⁹⁷ Estimate of remaining life of existing unit being replaced.

¹¹⁹⁸ Price includes new exit sign/fixture and installation. LED exit sign cost/unit is \$22.50 based on the NYSERDA Deemed Savings Database and review of LED exit signs available as of April 2023, and assuming 1 labor cost of 15 minutes @ \$40/hr.

¹¹⁹⁹ Assuming continuous operation of an LED exit sign, the Summer Peak Coincidence Factor is assumed to equal 1.0.

¹²⁰⁰ Based on review of available product.

Baseline Type	Watts _{Base}
CFL (dual sided)	14W ¹²⁰¹
CFL (single sided)	7W
Unknown	7W

Watts_{EE} = Actual wattage if known, if single sided or unknown assume 2W, if dual sided assume 4W.¹²⁰²

HOURS = Annual operating hours
= 8766

WHF_e = Waste heat factor for energy; accounts for cooling savings from efficient lighting.
= 1.04¹²⁰³

Default if replacing incandescent fixture

$$\Delta\text{kWh} = (35 - 2)/1000 * 8766 * 1.04$$

$$= 301 \text{ kWh}$$

Default if replacing dual sided fluorescent fixture

$$\Delta\text{kWh} = (14 - 4)/1000 * 8766 * 1.04$$

$$= 91 \text{ kWh}$$

Default if replacing single sided fluorescent (or unknown) fixture

$$\Delta\text{kWh} = (7 - 2)/1000 * 8766 * 1.04$$

$$= 46 \text{ kWh}$$

HEATING PENALTY

If electric heated home (if heating fuel is unknown assume gas, see Fossil Fuel section):

$$\Delta\text{kWh}^{1204} = - ((\text{WattsBase} - \text{WattsEE}) / 1000) * \text{Hours} * \text{HF} / \eta\text{Heat}$$

Where:

HF = Heating Factor or percentage of light savings that must be heated
= 49%¹²⁰⁵

ηHeat = Efficiency in COP of Heating equipment

¹²⁰¹ Average CFL single sided (5W, 7W, 9W) from Appendix B 2013-14 Table of Standard Fixture Wattages.

¹²⁰² Average LED single sided (2W) from Appendix B 2013-14 Table of Standard Fixture Wattages.

¹²⁰³ The value is estimated at 1.04 (calculated as $1 + (0.45 * (0.27 / 2.8))$). Based on cooling loads decreasing by 27% of the lighting savings (average result from REMRate modeling of several different configurations and IL locations of homes), assuming typical cooling system operating efficiency of 3.1 COP (starting from standard assumption of SEER 10.5 central AC unit, converted to 9.5 EER using algorithm $(-0.02 * \text{SEER}2) + (1.12 * \text{SEER})$ (from Wassmer, M. (2003). A Component-Based Model for Residential Air Conditioner and Heat Pump Energy Calculations. Masters Thesis, University of Colorado at Boulder), converted to $\text{COP} = \text{EER}/3.412 = 2.8\text{COP}$) and estimate of 45% of multi family buildings in Illinois having central cooling (based on data from "Table HC7.1 Air Conditioning in U.S. Homes, By Housing Unit Type, 2009" which is for the whole of the US, scaled to IL air conditioning prevalence compared to US average)

¹²⁰⁴ Negative value because this is an increase in heating consumption due to the efficient lighting.

¹²⁰⁵ This means that heating loads increase by 49% of the lighting savings. This is based on the average result from REMRate modeling of several different configurations and IL locations of homes.

= Actual. If not available use: ¹²⁰⁶

System Type	Age of Equipment	HSPF2 Estimate	COP _{HEAT} (COP Estimate) = (HSPF2/3.413)*0.85
Heat Pump (if age unknown assume 2006-2014)	Before 2006	5.8	1.44
	After 2006 - 2014	6.5	1.62
	2015 on	7.0	1.74
Resistance	N/A	N/A	1.00
Unknown ¹²⁰⁷	N/A	N/A	1.28

For example, a 2.0 COP (including duct loss) Heat Pump heated building:

If incandescent fixture: $\Delta kWh = -((35 - 2)/1000 * 8766 * 0.49) / 2$
 $= -71 kWh$

If unknown fixture $\Delta kWh = -((7 - 2)/1000 * 8766 * 0.49) / 2$
 $= -10.7 kWh$

SUMMER COINCIDENT PEAK DEMAND SAVINGS

$$\Delta kW = ((WattsBase - WattsEE) / 1000) * WHF_d * CF$$

Where:

WHF_d = Waste heat factor for demand to account for cooling savings from efficient lighting. The cooling savings are only added to the summer peak savings.
 $= 1.07^{1208}$

CF = Summer Peak Coincidence Factor for measure
 $= 1.0$

Default if incandescent fixture
 $\Delta kW = (35 - 2)/1000 * 1.07 * 1.0$
 $= 0.035 kW$

Default if dual sided fluorescent fixture
 $\Delta kW = (14 - 4)/1000 * 1.07 * 1.0$
 $= 0.0107 kW$

Default if single sided fluorescent fixture
 $\Delta kW = (7 - 2)/1000 * 1.07 * 1.0$

¹²⁰⁶ These default system efficiencies are based on the applicable minimum Federal Standards. In 2006 the Federal Standard for Heat Pumps was adjusted. While one would expect the average system efficiency to be higher than this minimum, the likely degradation of efficiencies over time mean that using the minimum standard is appropriate. Note efficiency should include duct losses. Defaults provided assume 15% duct loss for heat pumps.

¹²⁰⁷ Calculation assumes 35% Heat Pump and 65% Resistance, which is based upon data from Energy Information Administration, 2009 Residential Energy Consumption Survey, see "HC6.9 Space Heating in Midwest Region.xls", using average for East North Central Region. Average efficiency of heat pump is based on assumption that 50% are units from before 2006 and 50% from 2006-2014. Program or evaluation data should be used to improve this assumption if available.

¹²⁰⁸ The value is estimated at 1.11 (calculated as $1 + (0.45 * 0.466 / 2.8)$). See footnote relating to WHF_e for details. Note the 46.6% factor represents the average Residential cooling coincidence factor calculated by dividing average load during the peak hours divided by the maximum cooling load.

$$= 0.0054 \text{ kW}$$

FOSSIL FUEL SAVINGS

Heating penalty if Natural Gas heated building, or if heating fuel is unknown.

$$\Delta\text{Therms} = - ((\text{WattsBase} - \text{WattsEE}) / 1000) * \text{Hours} * \text{HF} * 0.03412 / \eta\text{Heat}$$

Where:

HF = Heating factor, or percentage of lighting savings that must be replaced by heating system.

$$= 49\%^{1209}$$

0.03412 = Converts kWh to Therms

ηHeat = Average heating system efficiency.

$$= 0.70^{1210}$$

Other factors as defined above

Default if incandescent fixture

$$\begin{aligned} \Delta\text{Therms} &= - ((35 - 2) / 1000) * 8766 * 0.49 * 0.03412 / 0.70 \\ &= -6.9 \text{ therms} \end{aligned}$$

Default if dual sided fluorescent fixture

$$\begin{aligned} \Delta\text{Therms} &= - ((14 - 4) / 1000) * 8766 * 0.49 * 0.03412 / 0.70 \\ &= -2.1 \text{ therms} \end{aligned}$$

Default if single sided fluorescent fixture

$$\begin{aligned} \Delta\text{Therms} &= - ((7 - 2) / 1000) * 8766 * 0.49 * 0.03412 / 0.70 \\ &= -1.05 \text{ therms} \end{aligned}$$

WATER IMPACT DESCRIPTIONS AND CALCULATION

N/A

DEEMED O&M COST ADJUSTMENT CALCULATION

The annual O&M Cost Adjustment savings should be calculated using the following component costs and lifetimes.

Component	Baseline Measures	
	Cost	Life (yrs)
Lamp	\$12.45 ¹²¹¹	1.37 years ¹²¹²

¹²⁰⁹ Average result from REMRate modeling of several different configurations and IL locations of homes

¹²¹⁰ This has been estimated assuming that natural gas central furnace heating is typical for Illinois residences (66% of Illinois homes have a Natural Gas Furnace (based on Energy Information Administration, 2009 Residential Energy Consumption Survey) In 2000, 24% of furnaces purchased in Illinois were condensing (based on data from GAMA, provided to Department of Energy during the federal standard setting process for residential heating equipment - see Furnace Penetration.xls). Furnaces tend to last up to 20 years and so units purchased 10 years ago provide a reasonable proxy for the current mix of furnaces in the State. Assuming typical efficiencies for condensing and non-condensing furnaces and duct losses, the average heating system efficiency is estimated as follows:

$$(0.24 * 0.92) + (0.76 * 0.8) * (1 - 0.15) = 0.70$$

¹²¹¹ Consistent with assumption for a Standard CFL bulb (\$2.45) with an estimated labor cost of \$10 (assuming \$40/hour and a task time of 15 minutes).

¹²¹² Assumes a lamp life of 12,000 hours and 8766 run hours 12000/8766 = 1.37 years.

MEASURE CODE: RS-LTG-LEDE-V04-240101

REVIEW DEADLINE: 1/1/2028

5.5.8 LED Screw Based Omnidirectional Bulbs

DESCRIPTION

Please note that this measure characterization contains specific assumptions that were negotiated as a compromise between the utilities and stakeholders and also reflects input from community-based organizations. The compromise is designed to allow for a gradual change in Income Qualified programming and to address the unique challenges that an abrupt change makes within the context of the Illinois CPAS savings goal structure. Such compromise shall not be taken as precedent for future non-consensus discussions.

This characterization provides savings assumptions for LED Screw Based Omnidirectional (e.g., A-Type lamps) lamps within the Income Qualified residential and multifamily sectors. This characterization assumes that the LED lamp is installed in a residential location. For stores easily accessed by income qualified communities, 100% of sales are assumed to be Income Qualified (IQ) residential.

This measure was developed to be applicable to the following program types: TOS, NC, EREP, DI, KITS.

If applied to other program types, the measure savings should be verified.

DEFINITION OF EFFICIENT EQUIPMENT

In order for this characterization to apply, new lamps must be ENERGY STAR labeled or equivalent to the most recent version of ENERGY STAR specifications. Note a new ENERGY STAR specification v2.1 became effective on 1/2/2017.

DEFINITION OF BASELINE EQUIPMENT

In 2012, Federal legislation stemming from the Energy Independence and Security Act of 2007 (EISA) will require all general-purpose light bulbs between 40 watts and 100 watts to have ~30% increased efficiency, essentially phasing out standard incandescent technology. In 2012, the 100 w lamp standards apply; in 2013 the 75 w lamp standards will apply, followed by restrictions on the 60 w and 40 w lamps in 2014. Since measures installed under this TRM all occur after 2014, baseline equipment are the values after EISA. These are shown in the baseline table below.

Additionally, an EISA backstop provision was included that would require replacement baseline lamps to meet an efficacy requirement of 45 lumens/watt or higher beginning on 1/1/2020. In December 2019, DOE issued a final determination for General Service Incandescent Lamps (GSILs), finding that this more stringent standard was not economically justified. However, in May 2022 DOE reversed this decision by issuing a Final rule for both the broadened General Service Lamp definition as well as the implementation of the 45 lumen per watt backstop. DOE stated that it will use its enforcement discretion to minimize impacts on the supply chain and effectively allow companies to continue the manufacture and import of noncompliant bulbs through the remainder of 2022, and allow retailers to continue selling them with limited enforcement until July 2023.

As of 6/30/2023, no savings are claimed for non-income qualified programs unless via direct install programs. Direct Install programs where it can be shown that the LED is replacing working inefficient lighting should continue to use the existing inefficient lighting as baseline and also assume a measure life of 2 years.

Income Qualified Programs

Through 2025, Retail programs in stores ‘easily accessed by income qualified communities’ (as defined below), and Kit, School and Foodbank programs, will continue to assume a halogen baseline and apply a measure life of 8 years.

A store is considered easily accessed by income qualified communities¹²¹³:

- c. For Ameren:

¹²¹³ Utilities to provide list of all stores that are easily accessed by income qualified communities, as defined above, by December 31, 2022, with one of the utility's quarterly reports and to the utility's independent evaluator. The Utilities will update the list of stores annually, by December 31 of each year of the current portfolio cycle in a similar fashion.

- i. if it is a retail store that is closest to a community with a zip code that has 65% of family households with an income less than or equal to 299% of the Federal poverty level for their household size (Applies to big box (e.g., Walmart), club (e.g., Costco), DIY (e.g., Home Depot), hardware and grocery stores); or
 - ii. If it is a "dollar store" in the AIC service area; or
 - iii. If it is a "thrift store" in the AIC service area.
- d. For ComEd:
- i. if it is a retail store is within a zip code where at least 60% or more of the households are at or below 80% Area Median Income (AMI); or
 - ii. If it is a "dollar store" in the ComEd service area; or
 - iii. If it is a "thrift store" in the ComEd service area.

100% of sales from such stores as defined above will count as IQ lighting.

Direct Install programs where it can be shown that the LED is replacing working inefficient lighting should continue to use the existing inefficient lighting as baseline and also assume a measure life of 8 years.

DEEMED LIFETIME OF EFFICIENT EQUIPMENT

The average rated life for Omnidirectional lamps on the ENERGY STAR Qualified Products list (accessed 6/16/2020) is approximately 20,000 hours.

However, for all purchases through 2025 the measure life is assumed to be two years for Direct Install in non-income eligible populations and eight years for income eligible populations.

DEEMED MEASURE COST

The price of LED lamps is falling quickly. Where possible, the actual LED lamp cost should be used and compared to the baseline cost provided below. If the incremental cost is unknown, assume the following:¹²¹⁴

Year	EISA Compliant Halogen	LED A-Lamp	Incremental Cost
2020 and on	\$1.25	\$2.70	\$1.45

LOADSHAPE

Loadshape R06 – Residential Indoor Lighting

Loadshape R07 – Residential Outdoor Lighting

COINCIDENCE FACTOR

The summer peak coincidence factor is assumed to be 0.128 for Residential and in-unit Multi Family bulbs,¹²¹⁵ 0.273 for exterior bulbs,¹²¹⁶ and 0.135 for unknown,¹²¹⁷

¹²¹⁴ Baseline and LED lamp costs are based on field data collected by CLEAResult and provided by ComEd. See ComEd Pricing Projections 06302016.xlsx for analysis.

¹²¹⁵ Based on the IL Statewide LED Lighting Logger study conducted as part of the PY8/PY9 evaluations of the Ameren Illinois and ComEd Residential Lighting programs.

¹²¹⁶ Based on lighting logger study conducted as part of the PY5/6 ComEd Residential Lighting Program evaluation. the IL Statewide LED Lighting Logger study conducted as part of the PY8/PY9 evaluations of the Ameren Illinois and ComEd Residential Lighting programs was unable to provide coincidence factors for screw-based omnidirectional LEDs in exterior applications.

¹²¹⁷Based on a weighted average of coincidence factors in interior and exterior applications, assuming 5% exterior lighting. The distribution of LEDs is based on the on-site lighting inventory conducted as part of the IL Statewide LED Lighting Logger study.

Use Multifamily if: Building meets utility’s definition for multifamily.

Algorithm

CALCULATION OF SAVINGS

ELECTRIC ENERGY SAVINGS

$$\Delta kWh = ((Watts_{base} - Watts_{EE}) / 1000) * ISR * (1 - Leakage) * Hours * WHF_e$$

Where:

Watts_{base} = Input wattage of the existing or baseline system. Reference the “LED New and Baseline Assumptions” table for default values.

Watts_{EE} = Actual wattage of LED purchased / installed. If unknown, use default provided below:¹²¹⁸

LED New and Baseline Assumptions Table

Minimum Lumens	Maximum Lumens	LED Wattage (WattsEE)	Baseline (WattsBase)	Delta Watts (WattsEE)
310	399	4.0	25	21.0
400	749	6.6	29	22.4
750	899	9.6	43	33.4
900	1,399	13.1	53	39.9
1,400	1,999	16.0	72	56.0
2,000	2,999	21.8	150	128.2
3,000	3,299	28.9	200	171.1

ISR = In Service Rate, the percentage of lamps rebated that are actually in service.

Program	In Service Rate (ISR) ¹²¹⁹
Retail (Time of Sale)	97.9% ¹²²⁰
Direct Install	94.5% ¹²²¹

¹²¹⁸ See file “LED Lamp Updates 2021-06-09” for details on Guidehouse lamp wattage calculations based on equivalent baseline wattage and LED wattage of available ENERGY STAR product.

¹²¹⁹ In Service Rates now represent the lifetime In Service Rates with the second and third year installations discounted by the Real Discount Rate of 0.46%. Lifetime ISR assumptions for efficiency kits are based upon comparing with CFL Distribution First year ISR and multiplying by the CFL Distribution Final ISR value, capped at 95%, and second and third year estimates based on same proportion of future installs. For all other programs The 98% Lifetime ISR assumption is based upon the standard CFL measure in the absence of any better reference. This value is based upon review of two evaluations:

‘Nexus Market Research, RLW Analytics and GDS Associates study; “New England Residential Lighting Markdown Impact Evaluation, January 20, 2009’ and ‘KEMA Inc, Feb 2010, Final Evaluation Report; Upstream Lighting Program, Volume 1.’ This implies that only 2% of bulbs purchased are never installed. The second and third year installations are based upon Ameren analysis of the Californian KEMA study showing that 54% of future installs occur in year 2 and 46% in year 3.

¹²²⁰ 1st year in service rate is based upon analysis of ComEd PY8, PY9 and CY2018 and Ameren PY8 intercept data (see ‘RES Lighting ISR_2019.xlsx’ for more information).

¹²²¹ Based upon average of Navigant low income single family direct install field work LED ISR and Standard CFL assumption in the absence of better data, and is based upon review of the PY2 and PY3 ComEd Direct Install program surveys. This value includes bulb failures in the 1st year to be consistent with the Commission approval of annualization of savings for first year

Program		In Service Rate (ISR) ¹²¹⁹
Virtual Assessment followed by Unverified Self-Install		97.9% ¹²²²
Efficiency Kits ¹²²³	LED Distribution ¹²²⁴	82.8%
	School Kits ¹²²⁵	83.8%
	Direct Mail Kits ¹²²⁶	91.8%
	Direct Mail Kits, Income Qualified ¹²²⁷	60%
	Community Distributed Kits ¹²²⁸	95.0%
Food Bank / Pantry Distribution ¹²²⁹		97.9% ¹²³⁰

Leakage = Adjustment to account for the percentage of program bulbs that move out (and in if deemed appropriate)¹²³¹ of the Utility Jurisdiction.

KITS programs = Determined through evaluation

Upstream (TOS) Lighting programs = Use deemed assumptions below:¹²³²

ComEd: 0.8%

Ameren: 13.1%

All other programs = 0

Hours = Average hours of use per year

Installation Location	Hours
Residential and in-unit Multi Family	1,089 ¹²³³

savings claims. ComEd PY2 All Electric Single Family Home Energy Performance Tune-Up Program Evaluation, Navigant Consulting, December 21, 2010.

¹²²² An equal weighted average of Direct Install and Direct Mail Kit ISRs. Interest and applicability of measures confirmed through virtual assessment.

¹²²³ In Service Rates provided are for the bulb within a kit only. Given the significant differences in program design and the level of education provided through Efficiency Kits programs, the evaluators should apply the ISR estimated through evaluations (either past evaluations or the current program year evaluation) of the specific Efficiency Kits program. In cases where program-specific evaluation results for an ISR are unavailable, the default ISR values for Efficiency Kits provide may be used.

¹²²⁴ Free bulbs provided without request, with little or no education. Consistent with Standard CFL assumptions.

¹²²⁵ 1st year ISR for school kits based on ComEd PY9 data for the Elementary Energy Education program. Final ISR assumptions are based upon comparing with CFL Distribution First year ISR and multiplying by the CFL Distribution Final ISR value, and second and third year estimates based on same proportion of future installs.

¹²²⁶ Opt-in program to receive kits via mail, with little or no education. Consistent with Standard CFL assumptions.

¹²²⁷ Research from 2021 Ameren Illinois Income Qualified participant survey (customer self-report), available on IL SAG website: <https://ilsag.s3.amazonaws.com/AIC-Income-Qualified-Initiative-Participant-Survey-Results-Memo-FINAL-2022-02-01.pdf>

¹²²⁸ Kits distributed in a community setting, targeted to income qualified communities. Research from 2018 Ameren Illinois Income Qualified participant survey.

¹²²⁹ Free bulbs provided through local food banks and food pantries.

¹²³⁰ 1st year ISR is determined based on online surveys conducted for ComEd CY2018 Food Bank LED Distribution program. See 'CY2018 ComEd Foodbank LED Dist Survey Results_Navigant'.

¹²³¹ Leakage in is only appropriate to credit to IL utility program savings if it is reasonably expected that the IL utility program marketing efforts played an important role in influencing customer to purchase the light bulbs. Furthermore, consideration that such customers might be free riders should be addressed. If leakage in is assessed, efforts should be made to ensure no double counting of savings occurs if the evaluation is estimating both leakage in and spillover savings of light bulbs.

¹²³² Leakage rate is based upon review of PY8-CY2018 evaluations from ComEd and PY8 for Ameren.

¹²³³ Based on the IL Statewide LED Lighting Logger study conducted as part of the PY8/PY9 evaluations of the Ameren Illinois and ComEd Residential Lighting programs.

Installation Location	Hours
Exterior	2,475 ¹²³⁴
Unknown	1,159 ¹²³⁵

WHFe = Waste heat factor for energy to account for cooling energy savings from efficient lighting

Bulb Location	WHFe
Interior single family	1.06 ¹²³⁶
Multifamily in unit	1.04 ¹²³⁷
Exterior or uncooled location	1.0
Unknown location	1.051 ¹²³⁸

For example, an 8W LED lamp, 450 lumens, is installed in the interior of a home. The customer purchased the lamp through a ComEd upstream program:

$$\begin{aligned} \Delta kWh &= ((29.0 - 8) / 1000) * 0.784 * (1 - 0.008) * 1,089 * 1.06 \\ &= 18.9 \text{ kWh} \end{aligned}$$

HEATING PENALTY

If electric heated home (if heating fuel is unknown assume gas, see Fossil Fuel section):

$$\Delta kWh^{1239} = - (((WattsBase - WattsEE) / 1000) * ISR * (1 - Leakage) * Hours * HF) / \eta_{Heat}$$

Where:

$$\begin{aligned} HF &= \text{Heating Factor or percentage of lighting savings that must be heated} \\ &= 49\% \text{ for interior}^{1240} \end{aligned}$$

¹²³⁴ Based on lighting logger study conducted as part of the PY5/6 ComEd Residential Lighting Program evaluation. The IL Statewide LED Lighting Logger study conducted as part of the PY8/PY9 evaluations of the Ameren Illinois and ComEd Residential Lighting programs was unable to provide hours of use for screw-based omnidirectional LEDs in exterior applications.

¹²³⁵ Based on a weighted average of hours of use in interior and exterior applications, assuming 5% exterior lighting. The distribution of LEDs is based on the on-site lighting inventory conducted as part of the IL Statewide LED Lighting Logger study.

¹²³⁶ The value is estimated at 1.06 (calculated as $1 + (0.66 * (0.27 / 2.8))$). Based on cooling loads decreasing by 27% of the lighting savings (average result from REMRate modeling of several different configurations and IL locations of homes), assuming typical cooling system operating efficiency of 2.8 COP (starting from standard assumption of SEER 10.5 central AC unit, converted to 9.5 EER using algorithm $(-0.02 * SEER2) + (1.12 * SEER)$ (from Wassmer, M. (2003). A Component-Based Model for Residential Air Conditioner and Heat Pump Energy Calculations. Masters Thesis, University of Colorado at Boulder), converted to $COP = EER / 3.412 = 2.8COP$) and 66% of homes in Illinois having central cooling ("Table HC7.9 Air Conditioning in Homes in Midwest Region, Divisions, and States, 2009 from Energy Information Administration", 2009 Residential Energy Consumption Survey)

¹²³⁷ As above but using estimate of 45% of multifamily buildings in Illinois having central cooling (based on data from "Table HC7.1 Air Conditioning in U.S. Homes, By Housing Unit Type, 2009" which is for the whole of the US, scaled to IL air conditioning prevalence compared to US average)

¹²³⁸ Unknown is weighted average of interior v exterior (assuming 5% exterior lighting based on distribution of LEDs from on-site lighting inventory conducted as part of the IL Statewide LED Lighting Logger study) and SF v MF interior based on statewide weighted average of 69% single family and 31% multifamily, based on IL data from 2009 RECS Table HC2.9 Structural and Geographic Characteristics of Homes in Midwest Region, Divisions and States, 2009.

¹²³⁹ Negative value because this is an increase in heating consumption due to the efficient lighting.

¹²⁴⁰ This means that heating loads increase by 49% of the lighting savings. This is based on the average result from REMRate modeling of several different configurations and IL locations of homes.

- = 0% for exterior or unheated location
- = 42% for unknown location¹²⁴¹
- η_{Heat} = Efficiency in COP of Heating equipment
- = actual. If not available use:¹²⁴²

System Type	Age of Equipment	HSPF2 Estimate	COP _{HEAT} (COP Estimate) = (HSPF2/3.413)*0.85
Heat Pump (if age unknown assume 2006-2014)	Before 2006	5.8	1.44
	After 2006 - 2014	6.5	1.62
	2015 on	7.0	1.74
Resistance	N/A	N/A	1.00
Unknown ¹²⁴³	N/A	N/A	1.28

For example: using the same 8 W LED that is installed in home with 2.0 COP Heat Pump (including duct loss) through a ComEd upstream program:

$$\Delta \text{kWh}_{1\text{st year}} = - ((29 - 8) / 1000) * 0.784 * (1 - 0.008) * 1,089 * 0.42 / 2.0$$

$$= - 3.7 \text{ kWh}$$

Second and third year install savings should be calculated using the appropriate ISR and the delta watts and hours from the install year.

SUMMER COINCIDENT PEAK DEMAND SAVINGS

$$\Delta \text{kW} = ((\text{WattsBase} - \text{WattsEE}) / 1000) * \text{ISR} * (1 - \text{Leakage}) * \text{WHFd} * \text{CF}$$

Where:

WHFd = Waste heat factor for demand to account for cooling savings from efficient lighting.

Bulb Location	WHFd
Interior single family	1.11 ¹²⁴⁴
Multifamily in unit	1.07 ¹²⁴⁵
Exterior or uncooled location	1.0

¹²⁴¹ Based on a weighted average of interior and exterior hours of use from the IL Statewide LED Lighting Logger study conducted as part of the PY8/PY9 evaluations of the Ameren Illinois and ComEd Residential Lighting programs, assuming 15% exterior specialty lighting. The distribution of LEDs is based on the on-site lighting inventory conducted as part of the IL Statewide LED Lighting Logger study.

¹²⁴² These default system efficiencies are based on the applicable minimum Federal Standards. In 2006 the Federal Standard for Heat Pumps was adjusted. While one would expect the average system efficiency to be higher than this minimum, the likely degradation of efficiencies over time mean that using the minimum standard is appropriate. Note efficiency should include duct losses. Defaults provided assume 15% duct loss for heat pumps.

¹²⁴³ Calculation assumes 35% Heat Pump and 65% Resistance, which is based upon data from Energy Information Administration, 2009 Residential Energy Consumption Survey, see "HC6.9 Space Heating in Midwest Region.xls", using average for East North Central Region. Average efficiency of heat pump is based on assumption that 50% are units from before 2006 and 50% from 2006-2014. Program or evaluation data should be used to improve this assumption if available.

¹²⁴⁴ The value is estimated at 1.11 (calculated as 1 + (0.66 * 0.466 / 2.8)). See footnote relating to WHFe for details. Note the 46.6% factor represents the average Residential cooling coincidence factor calculated by dividing average load during the peak hours divided by the maximum cooling load.

¹²⁴⁵ As above but using estimate of 45% of multifamily buildings in Illinois having central cooling (based on data from "Table HC7.1 Air Conditioning in U.S. Homes, By Housing Unit Type, 2009" which is for the whole of the US, scaled to IL air conditioning prevalence compared to US average)

Bulb Location	WHFd
Unknown location	1.093 ¹²⁴⁶

CF = Summer Peak Coincidence Factor for measure.

Bulb Location	CF
Interior	0.128 ¹²⁴⁷
Exterior	0.273 ¹²⁴⁸
Unknown	0.135 ¹²⁴⁹

Other factors as defined above

For example: for the same 8 W LED that is installed in a single family interior location through a ComEd upstream program:

$$\begin{aligned} \Delta kW &= ((29 - 8) / 1000) * 0.784 * (1 - 0.008) * 1.11 * 0.128 \\ &= 0.0023 \text{ kW} \end{aligned}$$

Second and third year install savings should be calculated using the appropriate ISR and the delta watts and hours from the install year.

FOSSIL FUEL SAVINGS

Heating penalty if Natural Gas heated home, or if heating fuel is unknown.

$$\Delta \text{Therms} = -(((\text{WattsBase} - \text{WattsEE}) / 1000) * \text{ISR} * (1 - \text{Leakage}) * \text{Hours} * \text{HF} * 0.03412) / \eta \text{Heat}$$

Where:

HF = Heating factor, or percentage of lighting savings that must be replaced by heating system.

= 49% for interior¹²⁵⁰

= 0% for exterior location

= 42% for unknown location¹²⁵¹

0.03412 = Converts kWh to Therms

η Heat = Average heating system efficiency.

¹²⁴⁶ Unknown is weighted average of interior v exterior (assuming 5% exterior lighting based on distribution of LEDs from on-site lighting inventory conducted as part of the IL Statewide LED Lighting Logger study) and SF v MF interior based on statewide weighted average of 69% single family and 31% multifamily, based on IL data from 2009 RECS Table HC2.9 Structural and Geographic Characteristics of Homes in Midwest Region, Divisions and States, 2009.

¹²⁴⁷ Based on the IL Statewide LED Lighting Logger study conducted as part of the PY8/PY9 evaluations of the Ameren Illinois and ComEd Residential Lighting programs.

¹²⁴⁸ Based on lighting logger study conducted as part of the PY5/6 ComEd Residential Lighting Program evaluation. the IL Statewide LED Lighting Logger study conducted as part of the PY8/PY9 evaluations of the Ameren Illinois and ComEd Residential Lighting programs was unable to provide coincidence factors for screw-based omnidirectional LEDs in exterior applications.

¹²⁴⁹ Based on a weighted average of coincidence factors in interior and exterior applications, assuming 5% exterior lighting. The distribution of LEDs is based on the on-site lighting inventory conducted as part of the IL Statewide LED Lighting Logger study.

¹²⁵⁰ Average result from REMRate modeling of several different configurations and IL locations of homes

¹²⁵¹ Based on a weighted average of interior and exterior hours of use from the IL Statewide LED Lighting Logger study conducted as part of the PY8/PY9 evaluations of the Ameren Illinois and ComEd Residential Lighting programs, assuming 15% exterior specialty lighting. The distribution of LEDs is based on the on-site lighting inventory conducted as part of the IL Statewide LED Lighting Logger study.

$$= 0.70^{1252}$$

WATER IMPACT DESCRIPTIONS AND CALCULATION

N/A

DEEMED O&M COST ADJUSTMENT CALCULATION

For income eligible populations, an annual baseline cost of \$1 should be applied.

It is important to note that for cost-effectiveness screening purposes, the O&M cost adjustments should only be applied in cases where the light bulbs area actually in service and so should be multiplied by the appropriate ISR:

MEASURE CODE: RS-LTG-LEDA-V16-240101

REVIEW DEADLINE: 1/1/2026

¹²⁵² This has been estimated assuming that natural gas central furnace heating is typical for Illinois residences (66% of Illinois homes have a Natural Gas Furnace (based on Energy Information Administration, 2009 Residential Energy Consumption Survey) In 2000, 24% of furnaces purchased in Illinois were condensing (based on data from GAMA, provided to Department of Energy during the federal standard setting process for residential heating equipment - see Furnace Penetration.xls). Furnaces tend to last up to 20 years and so units purchased 10 years ago provide a reasonable proxy for the current mix of furnaces in the State. Assuming typical efficiencies for condensing and non-condensing furnaces and duct losses, the average heating system efficiency is estimated as follows:

$$(0.24*0.92) + (0.76*0.8) * (1-0.15) = 0.70$$

5.5.9 LED Fixtures

DESCRIPTION

Please note that this measure characterization contains specific assumptions that were negotiated as a compromise between the utilities and stakeholders and also reflects input from community-based organizations. The compromise is designed to allow for a gradual change in Income Qualified programming and to address the unique challenges that an abrupt change makes within the context of the Illinois CPAS savings goal structure. Such compromise shall not be taken as precedent for future non-consensus discussions.

This characterization provides savings assumptions for LED Fixtures and is broken into five ENERGY STAR fixture types: Indoor Fixtures (including track lighting, wall-wash, sconces, ceiling and fan lights), Task and Downlight Under Cabinet Fixtures, including LED desk lamps (linear under cabinet fixtures are exempt from EISA and so can be found in measure 5.5.13), Outdoor Fixtures (including flood light, hanging lights, security/path lights, outdoor porch lights), and Downlight Fixtures.

For stores easily accessed by income qualified communities, 100% of sales are assumed to be Income Qualified (IQ) residential.

This measure was developed to be applicable to the following program types: TOS, NC.

If applied to other program types, the measure savings should be verified.

DEFINITION OF EFFICIENT EQUIPMENT

In order for this characterization to apply, new fixtures must be ENERGY STAR labeled based upon the v2.1 ENERGY STAR specification for luminaires or equivalent to the most recent version of ENERGY STAR specifications. Specifications are as follows:

Fixture Category	Lumens/Watt
Indoor	65
Downlight Task and Under Cabinet	50
Outdoor	60
Downlight	55

DEFINITION OF BASELINE EQUIPMENT

The baseline condition for this measure is assumed to be an average of EISA-equivalent wattages for ENERGY STAR-qualified products. Most of the lamp types in this measure are considered specialty so the baseline adjustments are consistent with the 5.5.6 LED Specialty Lamps.

Specialty and Directional lamps were not included in the original definition of General Service Lamps in the Energy Independence and Security Act of 2007 (EISA). Therefore, the initial baseline is an incandescent / halogen lamp described in the tables below.

A DOE Final Rule released on 1/19/2017 updated the EISA regulations to remove the exemption for these lamp types such that they become subject to the backstop provision defined within the original legislation. In September 2019 this decision was revoked in a DOE Final Rule. However, in May 2022 DOE reversed this decision by issuing a Final rule for both the broadened General Service Lamp definition as well as the implementation of the 45 lumen per watt backstop. DOE stated that it will use its enforcement discretion to minimize impacts on the supply chain and effectively allow companies to continue the manufacture and import of noncompliant bulbs through the remainder of 2022, and allow retailers to continue selling them with limited enforcement until July 2023.

As of 6/30/2023, no savings are claimed for non-income qualified programs unless via direct install programs. Direct Install programs where it can be shown that the LED is replacing working inefficient lighting should continue to use the existing inefficient lighting as baseline and also assume a measure life of 2 years.

Income Qualified Programs

Through 2025, Retail programs in stores ‘easily accessed by income qualified communities’ (as defined below), and Kit, School and Foodbank programs, will continue to assume a halogen baseline and apply a measure life of 8 years.

A store is considered easily accessed by income qualified communities¹²⁵³:

- a. For Ameren:
 - iv. if it is a retail store that is closest to a community with a zip code that has 65% of family households with an income less than or equal to 299% of the Federal poverty level for their household size (Applies to big box (e.g., Walmart), club (e.g., Costco), DIY (e.g., Home Depot), hardware and grocery stores); or
 - v. If it is a "dollar store" in the AIC service area; or
 - vi. If it is a "thrift store" in the AIC service area.
- b. For ComEd:
 - vii. if it is a retail store is within a zip code where at least 60% or more of the households are at or below 80% Area Median Income (AMI); or
 - viii. If it is a "dollar store" in the ComEd service area; or
 - ix. If it is a "thrift store" in the ComEd service area.

100% of sales from such stores as defined above will count as IQ lighting.

Direct Install programs where it can be shown that the LED is replacing working inefficient lighting should continue to use the existing inefficient lighting as baseline and also assume a measure life of 8 years.

DEEMED LIFETIME OF EFFICIENT EQUIPMENT

The lifetime of a fixture is a function of its rated life and average hours of use. The rated life is 47,000 hours for indoor and downlight, 45,000 for downlight task and under cabinet, and 49,000 for outdoor fixtures.¹²⁵⁴

However, for all purchases through 2025 the measure life is assumed to be two years for Direct Install non-income eligible populations and eight years for income eligible populations.

DEEMED MEASURE COST

Wherever possible, actual incremental costs should be used. If unavailable, assume the following incremental costs:

Fixture Category	Incremental Cost
Indoor	\$26 ¹²⁵⁵
Downlight Task /Under Cabinet	\$18 ¹²⁵⁶
Outdoor	\$26
Downlight	\$13

¹²⁵³ Utilities to provide list of all stores that are easily accessed by income qualified communities, as defined above, by December 31, 2022, with one of the utility's quarterly reports and to the utility's independent evaluator. The Utilities will update the list of stores annually, by December 31 of each year of the current portfolio cycle in a similar fashion.

¹²⁵⁴ Average rated lives are based on the average rated lives of fixtures available on the ENERGY STAR qualifying list as of 2/26/2018.

¹²⁵⁵ Incremental costs for indoor and outdoor fixtures based on ENERGY STAR Light Fixtures and Ceiling Fans Calculator, which cites “EPA research on available products, 2012.” ENERGY STAR cost assumptions were reduced by 20% to account for falling LED prices.

¹²⁵⁶ Incremental costs for task/under cabinet and downlight fixtures are from the 2018 Michigan Energy Measures Database.

LOADSHAPE

Loadshape R06 - Residential Indoor Lighting

Loadshape R07 - Residential Outdoor Lighting

COINCIDENCE FACTOR

The summer peak coincidence factor is assumed to be 0.119 for residential and in-unit multifamily fixtures,¹²⁵⁷ 0.273 for exterior fixtures,¹²⁵⁸ and 0.127 for unknown.¹²⁵⁹

Algorithm

CALCULATION OF SAVINGS

ELECTRIC ENERGY SAVINGS

$$\Delta kWh = ((Watts_{base} - Watts_{EE}) / 1000) * ISR * (1 - Leakage) * Hours * WHF_e$$

Where:

Watts_{Base} = Baseline is an average of lumen-equivalent EISA wattages for ENERGY STAR products within the fixture category;¹²⁶⁰ see table below.

Watts_{EE} = Actual wattage of LED fixture purchased / installed - If unknown, use default provided below:¹²⁶¹

Fixture Category	Watts _{Base}	Watts _{EE}
Indoor	88.5	22.4
Downlight Task and Under Cabinet	45.2	11.6
Outdoor	79.6	18.3
Downlight	72.8	20.3

ISR = In Service Rate, the percentage of units rebated that are actually in service
= 1.0¹²⁶²

Leakage = Adjustment to account for the percentage of program bulbs that move out (and in if deemed appropriate)¹²⁶³ of the Utility Jurisdiction.

¹²⁵⁷ Based on the IL Statewide LED Lighting Logger study conducted as part of the PY8/PY9 evaluations of the Ameren Illinois and ComEd Residential Lighting programs. Average of values for standard and specialty bulbs.

¹²⁵⁸ Based on lighting logger study conducted as part of the PY5/6 ComEd Residential Lighting Program evaluation. the IL Statewide LED Lighting Logger study conducted as part of the PY8/PY9 evaluations of the Ameren Illinois and ComEd Residential Lighting programs was unable to provide coincidence factors for screw-based omnidirectional LEDs in exterior applications.

¹²⁵⁹ Based on a weighted average of coincidence factors in interior and exterior applications, assuming 5% exterior lighting. The distribution of LEDs is based on the on-site lighting inventory conducted as part of the IL Statewide LED Lighting Logger study.

¹²⁶⁰ See "Analysis" tab within file Residential LED Fixtures_Analysis_June 2018.xlsx for baseline calculations.

¹²⁶¹ Average of ENERGY STAR product category watts for products at or above the version 2.1 efficacy specification

¹²⁶² ISR recommendation for fixtures in the Dunsky Energy Consulting, Livingston Energy Innovations and Opinion Dynamics Corporation; NEEP Emerging Technology Research Report, p 6-22.

¹²⁶³ Leakage in is only appropriate to credit to IL utility program savings if it is reasonably expected that the IL utility program marketing efforts played an important role in influencing customer to purchase the light bulbs. Furthermore, consideration that such customers might be free riders should be addressed. If leakage in is assessed, efforts should be made to ensure no double counting of savings occurs if the evaluation is estimating both leakage in and spillover savings of light bulbs.

Upstream (TOS) Lighting programs = Use deemed assumptions below:¹²⁶⁴

ComEd: 0.7%
Ameren: 6.6%

All other programs = 0

Hours = Average hours of use per year

Fixture Category	Hours
Indoor and Downlight	926 ¹²⁶⁵
Task/Under Cabinet	730 ¹²⁶⁶
Outdoor	2,475 ¹²⁶⁷

WHFe = Waste heat factor for energy to account for cooling energy savings from efficient lighting

Bulb Location	WHFe
Interior single family	1.06 ¹²⁶⁸
Multifamily in unit	1.04 ¹²⁶⁹
Exterior or uncooled location	1.0
Unknown location	1.051 ¹²⁷⁰

For example, an indoor LED fixture is purchased through a ComEd retail program in 2019:

$$\begin{aligned} \Delta\text{kWh} &= ((88.5 - 22.4) / 1000) * 1.0 * (1 - 0.007) * 926 * 1.06 \\ &= 64.4 \text{ kWh} \end{aligned}$$

¹²⁶⁴ Leakage rate is based upon review of PY7-9 evaluations from ComEd and PY8 for Ameren (see for more information) for LED omnidirectional and specialty lamps. Leakage rates for fixtures are an average of rates for standard and specialty lamps, reduced by half according to TAC agreement.

¹²⁶⁵ Assuming 365.25 days/year and average of recommended values for standard LED lamps (2.98) and specialty LED lamps (2.09) in interior locations from the IL Statewide LED Lighting Logger study conducted as part of the PY8/PY9 evaluations of the Ameren Illinois and ComEd Residential Lighting programs

¹²⁶⁶ Task/under cabinet hours of use are estimated at 2 hours per day.

¹²⁶⁷ Based on lighting logger study conducted as part of the PY5/6 ComEd Residential Lighting Program evaluation. The IL Statewide LED Lighting Logger study conducted as part of the PY8/PY9 evaluations of the Ameren Illinois and ComEd Residential Lighting programs was unable to provide hours of use for screw-based omnidirectional LEDs in exterior applications.

¹²⁶⁸ The value is estimated at 1.06 (calculated as $1 + (0.66 * (0.27 / 2.8))$). Based on cooling loads decreasing by 27% of the lighting savings (average result from REMRate modeling of several different configurations and IL locations of homes), assuming typical cooling system operating efficiency of 2.8 COP (starting from standard assumption of SEER 10.5 central AC unit, converted to 9.5 EER using algorithm $(-0.02 * SEER2) + (1.12 * SEER)$ (from Wassmer, M. (2003). A Component-Based Model for Residential Air Conditioner and Heat Pump Energy Calculations. Masters Thesis, University of Colorado at Boulder), converted to $COP = EER/3.412 = 2.8COP$) and 66% of homes in Illinois having central cooling ("Table HC7.9 Air Conditioning in Homes in Midwest Region, Divisions, and States, 2009 from Energy Information Administration", 2009 Residential Energy Consumption Survey)

¹²⁶⁹ As above but using estimate of 45% of multifamily buildings in Illinois having central cooling (based on data from "Table HC7.1 Air Conditioning in U.S. Homes, By Housing Unit Type, 2009" which is for the whole of the US, scaled to IL air conditioning prevalence compared to US average)

¹²⁷⁰ Unknown is weighted average of interior v exterior (assuming 5% exterior lighting based on distribution of LEDs from on-site lighting inventory conducted as part of the IL Statewide LED Lighting Logger study) and SF v MF interior based on statewide weighted average of 69% single family and 31% multifamily, based on IL data from 2009 RECS Table HC2.9 Structural and Geographic Characteristics of Homes in Midwest Region, Divisions and States, 2009.

HEATING PENALTY

If electric heated home (if heating fuel is unknown assume gas, see Fossil Fuel section):

$$\Delta kWh^{1271} = - (((WattsBase - WattsEE) / 1000) * ISR * (1 - Leakage) * Hours * HF) / \eta_{Heat}$$

Where:

- HF = Heating Factor or percentage of light savings that must be heated
 - = 49%¹²⁷² for interior location
 - = 0% for exterior or unheated location
 - = 42%¹²⁷³ for unknown location
- η_{Heat} = Efficiency in COP of Heating equipment
 - = actual. If not available use:¹²⁷⁴

System Type	Age of Equipment	HSPF2 Estimate	COP _{HEAT} (COP Estimate) = (HSPF2/3.413)*0.85
Heat Pump (if age unknown assume 2006-2014)	Before 2006	5.8	1.44
	After 2006 - 2014	6.5	1.62
	2015 on	7.0	1.74
Resistance	N/A	N/A	1.00
Unknown ¹²⁷⁵	N/A	N/A	1.28

For example, using the same indoor LED fixture that is installed in home with 2.0 COP Heat Pump (including duct loss) through a ComEd retail program in 2019:

$$\begin{aligned} \Delta kWh_{1st\ year} &= - (((88.5 - 22.4) / 1000) * 1.0 * (1 - 0.007) * 926 * 0.49) / 2.0 \\ &= - 14.9\ kWh \end{aligned}$$

Second and third year install savings should be calculated using the appropriate ISR and the delta watts and hours from the install year. The appropriate baseline shift adjustment should then be applied to all installs.

SUMMER COINCIDENT PEAK DEMAND SAVINGS

$$\Delta kW = ((WattsBase - WattsEE) / 1000) * ISR * (1 - Leakage) * WHFd * CF$$

Where:

¹²⁷¹ Negative value because this is an increase in heating consumption due to the efficient lighting.

¹²⁷² This means that heating loads increase by 49% of the lighting savings. This is based on the average result from REMRate modeling of several different configurations and IL locations of homes.

¹²⁷³ Based on a weighted average of interior and exterior hours of use from the IL Statewide LED Lighting Logger study conducted as part of the PY8/PY9 evaluations of the Ameren Illinois and ComEd Residential Lighting programs, assuming 15% exterior specialty lighting. The distribution of LEDs is based on the on-site lighting inventory conducted as part of the IL Statewide LED Lighting Logger study.

¹²⁷⁴ These default system efficiencies are based on the applicable minimum Federal Standards. In 2006 the Federal Standard for Heat Pumps was adjusted. While one would expect the average system efficiency to be higher than this minimum, the likely degradation of efficiencies over time mean that using the minimum standard is appropriate. Note efficiency should include duct losses. Defaults provided assume 15% duct loss for heat pumps.

¹²⁷⁵ Calculation assumes 35% Heat Pump and 65% Resistance, which is based upon data from Energy Information Administration, 2009 Residential Energy Consumption Survey, see "HC6.9 Space Heating in Midwest Region.xls", using average for East North Central Region. Average efficiency of heat pump is based on assumption that 50% are units from before 2006 and 50% from 2006-2014. Program or evaluation data should be used to improve this assumption if available.

WHFd = Waste heat factor for demand to account for cooling savings from efficient lighting.

Bulb Location	WHFd
Interior single family	1.11 ¹²⁷⁶
Multifamily in unit	1.07 ¹²⁷⁷
Exterior or uncooled location	1.0
Unknown location	1.093 ¹²⁷⁸

CF = Summer Peak Coincidence Factor for measure.

Bulb Location	CF
Interior	0.119 ¹²⁷⁹
Exterior	0.273 ¹²⁸⁰
Unknown	0.127 ¹²⁸¹

Other factors as defined above

For example, for the same indoor LED fixture that is installed in a single family interior location through a ComEd retail program in 2019, the demand savings are:

$$\begin{aligned} \Delta kW &= ((88.5 - 22.4) / 1000) * 1.0 * (1-0.007) * 1.11 * 0.119 \\ &= 0.0087 \text{ kW} \end{aligned}$$

Second and third year install savings should be calculated using the appropriate ISR and the delta watts and hours from the install year. The appropriate baseline shift adjustment should then be applied to all installs.

FOSSIL FUEL SAVINGS

Heating penalty if Natural Gas heated home, or if heating fuel is unknown.

$$\Delta \text{Therms} = - (((\text{WattsBase} - \text{WattsEE}) / 1000) * \text{ISR} * (1 - \text{Leakage}) * \text{Hours} * \text{HF} * 0.03412) / \eta_{\text{Heat}}$$

Where:

HF = Heating factor, or percentage of lighting savings that must be replaced by heating system.

$$= 49\% \text{ for interior or unknown location}^{1282}$$

¹²⁷⁶ The value is estimated at 1.11 (calculated as $1 + (0.66 * 0.466 / 2.8)$). See footnote relating to WHFe for details. Note the 46.6% factor represents the average Residential cooling coincidence factor calculated by dividing average load during the peak hours divided by the maximum cooling load.

¹²⁷⁷ As above but using estimate of 45% of multifamily buildings in Illinois having central cooling (based on data from “Table HC7.1 Air Conditioning in U.S. Homes, By Housing Unit Type, 2009” which is for the whole of the US, scaled to IL air conditioning prevalence compared to US average)

¹²⁷⁸ Unknown is weighted average of interior v exterior (assuming 5% exterior lighting based on distribution of LEDs from on-site lighting inventory conducted as part of the IL Statewide LED Lighting Logger study) and SF v MF interior based on statewide weighted average of 69% single family and 31% multifamily, based on IL data from 2009 RECS Table HC2.9 Structural and Geographic Characteristics of Homes in Midwest Region, Divisions and States, 2009.

¹²⁷⁹ Based on the IL Statewide LED Lighting Logger study conducted as part of the PY8/PY9 evaluations of the Ameren Illinois and ComEd Residential Lighting programs. Average of values for standard and specialty bulbs.

¹²⁸⁰ Based on lighting logger study conducted as part of the PY5/6 ComEd Residential Lighting Program evaluation. the IL Statewide LED Lighting Logger study conducted as part of the PY8/PY9 evaluations of the Ameren Illinois and ComEd Residential Lighting programs was unable to provide coincidence factors for screw-based omnidirectional LEDs in exterior applications.

¹²⁸¹ Based on a weighted average of coincidence factors in interior and exterior applications, assuming 5% exterior lighting. The distribution of LEDs is based on the on-site lighting inventory conducted as part of the IL Statewide LED Lighting Logger study.

¹²⁸² Average result from REMRate modeling of several different configurations and IL locations of homes

	= 0% for exterior location
	= 42% for unknown location ¹²⁸³
0.03412	= Converts kWh to Therms
η_{Heat}	= Average heating system efficiency.
	= 0.70 ¹²⁸⁴

WATER IMPACT DESCRIPTIONS AND CALCULATION

N/A

DEEMED O&M COST ADJUSTMENT CALCULATION

For income eligible populations, an annual baseline cost of \$1.90 should be applied.

It is important to note that for cost-effectiveness screening purposes, the O&M cost adjustments should only be applied in cases where the light bulbs area actually in service and so should be multiplied by the appropriate ISR:

MEASURE CODE: RS-LTG-LDFX-V07-240101

REVIEW DEADLINE: 1/1/2026

¹²⁸³ Based on a weighted average of interior and exterior hours of use from the IL Statewide LED Lighting Logger study conducted as part of the PY8/PY9 evaluations of the Ameren Illinois and ComEd Residential Lighting programs, assuming 15% exterior specialty lighting. The distribution of LEDs is based on the on-site lighting inventory conducted as part of the IL Statewide LED Lighting Logger study.

¹²⁸⁴ This has been estimated assuming that natural gas central furnace heating is typical for Illinois residences (66% of Illinois homes have a Natural Gas Furnace (based on Energy Information Administration, 2009 Residential Energy Consumption Survey) In 2000, 24% of furnaces purchased in Illinois were condensing (based on data from GAMA, provided to Department of Energy during the federal standard setting process for residential heating equipment - see Furnace Penetration.xls). Furnaces tend to last up to 20 years and so units purchased 10 years ago provide a reasonable proxy for the current mix of furnaces in the State. Assuming typical efficiencies for condensing and non-condensing furnaces and duct losses, the average heating system efficiency is estimated as follows:

$$(0.24*0.92) + (0.76*0.8) * (1-0.15) = 0.70$$

5.5.10 Holiday String Lighting

DESCRIPTION

This measure categorizes the savings from customers handing in incandescent string lighting typically used during the holidays and receiving equivalent LED string lighting. LED bulbs on string lights can consume up to 98% less power when compared to incandescent bulbs. Besides less energy to operate, LED string lighting offers many other advantages over incandescent: longer bulb life, a higher brightness, less heat buildup making them safer especially when used indoors on live trees, and better durability since they use a plastic covering over the diode instead of a glass bulb.¹²⁸⁵

This measure applies to mini, C7, and C9 bulb shape types used in residential locations. Description of the bulb types of string lighting are listed below:^{1286, 1287}

- Mini: About 1/4" wide x 5/8" high with a shape described as a miniature candle with a pointed tip. The mini is the most common type of string light today and shares about 80% of the market. They have a female-to-male push type base.
- C7: Approximately 1" wide x 1-1/2" high with a shape described as a strawberry. The C7 (and C9) are thought of as more "old fashioned" or traditional since they were the first types of string lighting used for decorative purposes. The C7 shares about 7% of the market and has a screw-in E12 candelabra base.
- C9: Similar in shape to the C7, the C9 is slightly larger at 1-1/4" wide x 2-1/2" high. The C9 shares about 5% of the market and has a screw-in E17 intermediate base.

A third variant of the "C" bulb exists, which is called C6. However, due to lack of availability of the C6 incandescent from retailers, it is assumed the market has already adopted the LED as the baseline for this bulb shape type and should not be claimed for utility program savings.

The implementation strategy for this measure is only geared towards residential customers. Furthermore, the deemed hours of operation are sourced on residential only. As such, the proposed deemed split of 100% Residential and 0% Commercial assumptions should be used.

This measure was developed to be applicable to the following program types: EREP. To ensure that the baseline is appropriate, the measure is limited to an exchange event where the customer has to turn in a string of inefficient lighting.

If applied to other program types, the measure savings should be verified.

DEFINITION OF EFFICIENT EQUIPMENT

To qualify for this measure, new string lights must be LED and one of the eligible bulb shape categories listed in this measure (mini, C7, C9).

Some manufacturers offer integrated "smart" control of new LED strings; however, these are not included in this measure.

DEFINITION OF BASELINE EQUIPMENT

The baseline condition is the existing incandescent mini, C7, or C9 string lighting turned in during an exchange event.

DEEMED LIFETIME OF EFFICIENT EQUIPMENT

The rated lifespan of LED bulbs for string lighting is in the range of 20,000 to 100,000 hours of use. However, the measure lifetime is capped at 7 years due to wear on bulbs and string from weather, sunlight, and annual installation

¹²⁸⁵ See 'Christmas Lights Buying Guide – Hayneedle'.

¹²⁸⁶ See 'Christmas Lights Buying Guide – Hayneedle'.

¹²⁸⁷ See 'Christmas Lights Guide Visual'.

and storage.¹²⁸⁸

DEEMED MEASURE COST

Where possible, the actual, full cost of new LED string lighting should be used. If unavailable, assume the following costs.

Bulb Type	Measure Cost ¹²⁸⁹
Mini	\$15.38
C7	\$21.42
C9	\$17.28

Loadshape

Loadshape R16; Residential Holiday String Lighting

COINCIDENCE FACTOR

Due to the seasonal nature and evening operation of holiday string lights, there is no expected reduction in a utility’s peak demand.

Algorithm

CALCULATION OF ENERGY SAVINGS

ELECTRIC ENERGY SAVINGS

$$\Delta kWh = ((Watts_{base} - Watts_{EE}) / 1000) * ISR * (1 - Leakage) * Hours * WHF_e$$

Where:

Watts_{base} = Total wattage of the existing incandescent string lights = Bulb Wattage * # Bulbs; see table below for baseline bulb wattage assumptions

Watts_{EE} = Actual total wattage of the new LED string lights = Bulb Wattage * # Bulbs. If unknown, assume total wattage of new LED string lights = Bulb Wattage * # Bulbs; see table below for LED bulb wattage assumptions

Where:

Bulb Wattage = Reference the “Bulb Wattage Assumptions” table below.

Bulb Wattage Assumptions¹²⁹⁰

Type	Incandescent Bulb (Watts)	LED Bulb (Watts)
Mini	0.40	0.07
C7	5.00	0.48
C9	7.00	2.00

Bulbs = Actual quantity of bulbs on the string. If baseline is unknown, assume same as the new string.

ISR = In Service Rate, or percentage of string lights that get installed. Derive from program

¹²⁸⁸ LED string lighting lifetime from <https://www.christmasdesigners.com/blog/how-long-do-led-christmas-lights-really-last/> 'How Long Do LED Christmas Lights Really Last Christmas Designers'

¹²⁸⁹ See file Holiday Lights Research and Calcs_2018.xlsx for CLEAResult research on holiday string lighting costs.

¹²⁹⁰ Average wattages from PGE "Cost of holiday lights", published December 2021, and PA PUC Feb 2021.

evaluation analysis, otherwise assume 100%.

- Leakage = Adjustment to account for the percentage of program string lights that move out (and in, if deemed appropriate) of the Utility Jurisdiction.
 = For an exchange event, assume 0% if customer is required to be a utility customer. If not, determine leakage rate through evaluation. If customer is not required to be utility customer and if leakage is not determined through evaluation, use the deemed leakage rates LED omnidirectional bulbs sold through Upstream (TOS) programs:¹²⁹¹
 - ComEd: 1.6%
 - Ameren: 13.1%
- Hours = Average hours of use per year
 = 210 hours¹²⁹²
- WHFe = Waste heat factor for energy to account for cooling energy savings from efficient lighting, assumed value of 1.0 since operation of string lights (if indoors) does not coincide with cooling season and there are no interactive effects for outdoor string lights.

For example, a customer replaces a 50-bulb mini incandescent string with a 50-bulb mini LED string through exchange event:

$$\Delta kWh = ((0.40 * 50) - (0.07 * 50)) / 1000 * 1.00 * (1 - 0) * 210 * 1.0$$

$$= 3.5 kWh$$

HEATING PENALTY

If electric heated home (if heating fuel is unknown assume gas, see Fossil Fuel section):

$$\Delta kWh^{1293} = - (((WattsBase - WattsEE) / 1000) * ISR * (1 - Leakage) * Hours * HF) / \eta_{Heat}$$

Where:

- HF = Heating Factor or percentage of light savings that must be heated
 = 49% for interior or unknown location¹²⁹⁴
 = 0% for exterior or unheated location
- η_{Heat} = Efficiency in COP of Heating equipment
 = actual. If not available, use:¹²⁹⁵

System Type	Age of Equipment	HSPF2 Estimate	COPheat (COP Estimate) = (HSPF2/3.413) * 0.85
Heat Pump	Before 2006	5.8	1.44

¹²⁹¹ Leakage rate is based upon review of PY8-CY2018 evaluations from ComEd and PY8 for Ameren.

¹²⁹² Based on typical holiday lighting hours of use (6 hours per day, 7 days per week for 5 weeks) from California Municipal Utilities Association “TRM 205 LED Holiday Lights.”

¹²⁹³ Negative value because this is an increase in heating consumption due to the efficient lighting.

¹²⁹⁴ This means that heating loads increase by 49% of the lighting savings. This is based on the average result from REMRate modeling of several different configurations and IL locations of homes.

¹²⁹⁵ These default system efficiencies are based on the applicable minimum Federal Standards. In 2006 the Federal Standard for Heat Pumps was adjusted. While one would expect the average system efficiency to be higher than this minimum, the likely degradation of efficiencies over time mean that using the minimum standard is appropriate. Note efficiency should include duct losses. Defaults provided assume 15% duct loss for heat pumps.

System Type	Age of Equipment	HSPF2 Estimate	COPheat (COP Estimate) = (HSPF2/3.413) * 0.85
(if age unknown assume 2006-2014)	After 2006-2014	6.5	1.62
	2015 on	7.0	1.74
Resistance	N/A	N/A	1
Unknown ¹²⁹⁶	N/A	N/A	1.28

For example, using the same 50-bulb mini LED string that is installed in home with 2.0 COP Heat Pump (including duct loss):

$$\Delta kWh = - (((0.40 * 50) - (0.07 * 50)) / 1000) * 1.00 * (1 - 0) * 210 * 0.49 / 2.0$$

$$= - 0.8 kWh$$

SUMMER COINCIDENT PEAK DEMAND SAVINGS

N/A

SUMMER COINCIDENT PEAK DEMAND SAVINGS

N/A

FOSSIL FUEL SAVINGS

Heating penalty if installed in a natural gas heated home, or if heating fuel is unknown.

$$\Delta Therms = - (((WattsBase - WattsEE) / 1000) * ISR * (1 - Leakage) * Hours * HF * 0.03412) / \eta_{Heat}$$

Where:

- HF = Heating factor, or percentage of lighting savings that must be replaced by heating system.
= 49% for interior or unknown location ¹²⁹⁷
= 0% for exterior location
- 0.03412 = Converts kWh to Therms
- η_{Heat} = Actual heating system efficiency
= 70% ¹²⁹⁸

¹²⁹⁶ Calculation assumes 35% Heat Pump and 65% Resistance, which is based upon data from Energy Information Administration, 2009 Residential Energy Consumption Survey, see “HC6.9 Space Heating in Midwest Region.xls”, using average for East North Central Region. Average efficiency of heat pump is based on assumption that 50% are units from before 2006 and 50% from 2006-2014. Program or evaluation data should be used to improve this assumption if available.

¹²⁹⁷ Average result from REMRate modeling of several different configurations and IL locations of homes.

¹²⁹⁸ This has been estimated assuming that natural gas central furnace heating is typical for Illinois residences (66% of Illinois homes have a Natural Gas Furnace (based on Energy Information Administration, 2009 Residential Energy Consumption Survey). In 2000, 24% of furnaces purchased in Illinois were condensing (based on data from GAMA, provided to Department of Energy during the federal standard setting process for residential heating equipment - see Furnace Penetration.xls). Furnaces tend to last up to 20 years and so units purchased 10 years ago provide a reasonable proxy for the current mix of furnaces in the State. Assuming typical efficiencies for condensing and non-condensing furnaces and duct losses, the average heating system efficiency is estimated as follows:

$$(0.24 * 0.92) + (0.76 * 0.8) * (1 - 0.15) = 0.70$$

For example, using the same 50-bulb mini LED string that is installed in a single family interior location with gas heating at 70% total efficiency:

$$\begin{aligned}\Delta\text{therms} &= - (((0.40 * 50) - (0.07 * 50))/1000) * 1.00 * (1 - 0) * 210 * 0.49 * 0.03412 / 0.70 \\ &= - 0.08 \text{ therms}\end{aligned}$$

WATER IMPACT DESCRIPTIONS AND CALCULATION

N/A

DEEMED O&M COST ADJUSTMENT CALCULATION

N/A

MEASURE CODE: RS-LTG-LEDH-V04-250101

REVIEW DEADLINE: 1/1/2028

5.5.11 LED Nightlights

DESCRIPTION

This measure describes savings from LED nightlights. This characterization assumes that the LED nightlight is installed in a residential location.

This measure was developed to be applicable to the following program types: TOS, NC.

If applied to other program types, the measure savings should be verified.

DEFINITION OF EFFICIENT EQUIPMENT

For this characterization to apply, the high-efficiency equipment must be a qualified LED nightlight.

DEFINITION OF BASELINE EQUIPMENT

The baseline condition is assumed to be an incandescent/halogen nightlight.

DEEMED LIFETIME OF EFFICIENT EQUIPMENT

The estimated useful life of the is estimated is 8 years.¹²⁹⁹

DEEMED MEASURE COST

Where possible, the actual cost should be used and compared to the baseline cost. If the incremental cost is unknown, assume the following:¹³⁰⁰

Bulb Type	Year	Incandescent	LED	Incremental Cost
Nightlights	All	\$2.84	\$6.19	\$3.35

LOADSHAPE

Loadshape R07 - Residential Outdoor Lighting

COINCIDENCE FACTOR

Demand savings is assumed to be zero for this measure.

Algorithm

CALCULATION OF SAVINGS

ELECTRIC ENERGY SAVINGS

$$\Delta kWh = ((WattsBase - WattsEE) / 1000) * ISR * (1 - Leakage) * Hours * WHFe$$

Where:

Watts_{base} = Actual wattage if known, if unknown, assume 7W.¹³⁰¹

Watts_{EE} = Actual wattage of LED purchased / installed.

¹²⁹⁹ Southern California Edison Company, “LED, Electroluminescent & Fluorescent Night Lights”, Work Paper WPSCRELG0029 Rev. 1, February 2009, p. 2. and p.3.

¹³⁰⁰ Average cost data provided in Stanley Mertz, “LED Nightlights Energy Efficiency Retail products programs”, March 2018.

¹³⁰¹ Based on Stanley Mertz, “LED Nightlights Energy Efficiency Retail products programs”, March 2018.

ISR = In Service Rate or the percentage of nightlights rebated that get installed

Program	In Service Rate (ISR) ¹³⁰²
Retail (Time of Sale)	97.9% ¹³⁰³
Direct Install	96.9% ¹³⁰⁴
School Kits	83.8% ¹³⁰⁵

Leakage = Adjustment to account for the percentage of program bulbs that move out (and in if deemed appropriate)¹³⁰⁶ of the Utility Jurisdiction.

KITS programs = Determined through evaluation

Upstream (TOS) Lighting programs = Use deemed assumptions below:¹³⁰⁷

ComEd:	2.0%
Ameren:	13.1%

Hours = Average hours of use per year

= 4,380¹³⁰⁸

WHFe = Waste heat factor for energy to account for cooling savings from efficient lighting

Bulb Location	WHFe
Interior single family	1.06 ¹³⁰⁹

¹³⁰² In Service Rates now represent the lifetime In Service Rates with the second and third year installations discounted by the Real Discount Rate of 0.46%. Lifetime ISR assumptions for efficiency kits are based upon comparing with CFL Distribution First year ISR and multiplying by the CFL Distribution Final ISR value, capped at 95%, and second and third year estimates based on same proportion of future installs. For all other programs The 98% Lifetime ISR assumption is based upon the standard CFL measure in the absence of any better reference. This value is based upon review of two evaluations:

‘Nexus Market Research, RLW Analytics and GDS Associates study; ‘New England Residential Lighting Markdown Impact Evaluation, January 20, 2009’ and ‘KEMA Inc, Feb 2010, Final Evaluation Report: Upstream Lighting Program, Volume 1.’ This implies that only 2% of bulbs purchased are never installed. The second and third year installations are based upon Ameren analysis of the Californian KEMA study showing that 54% of future installs occur in year 2 and 46% in year 3.

¹³⁰³ 1st year in service rate is based upon analysis of ComEd PY8, PY9 and CY2018 and Ameren PY8 intercept data (see ‘RES Lighting ISR_2019.xlsx’ for more information).

¹³⁰⁴ Consistent with assumption for standard CFLs (in the absence of evidence that it should be different for this bulb type). Based upon review of the PY2 and PY3 ComEd Direct Install program surveys. This value includes bulb failures in the 1st year to be consistent with the Commission approval of annualization of savings for first year savings claims. ComEd PY2 All Electric Single Family Home Energy Performance Tune-Up Program Evaluation, Navigant Consulting, December 21, 2010.

¹³⁰⁵ 1st year ISR for school kits based on ComEd PY9 data for the Elementary Energy Education program.

¹³⁰⁶ Leakage in is only appropriate to credit to IL utility program savings if it is reasonably expected that the IL utility program marketing efforts played an important role in influencing customer to purchase the light bulbs. Furthermore, consideration that such customers might be free riders should be addressed. If leakage in is assessed, efforts should be made to ensure no double counting of savings occurs if the evaluation is estimating both leakage in and spillover savings of light bulbs.

¹³⁰⁷ Leakage rate is based upon review of PY7-9 evaluations from ComEd and PY5,6 and 8 for Ameren (see for more information).

¹³⁰⁸ Assumes nightlight is operating 12 hours per day, consistent with the 2016 Pennsylvania TRM.

¹³⁰⁹ The value is estimated at 1.06 (calculated as $1 + (0.66 * (0.27 / 2.8))$). Based on cooling loads decreasing by 27% of the lighting savings (average result from REMRate modeling of several different configurations and IL locations of homes), assuming typical cooling system operating efficiency of 2.8 COP (starting from standard assumption of SEER 10.5 central AC unit, converted to 9.5 EER using algorithm $(-0.02 * SEER2) + (1.12 * SEER)$ (from Wassmer, M. (2003). A Component-Based Model for Residential Air Conditioner and Heat Pump Energy Calculations. Masters Thesis, University of Colorado at Boulder), converted to $COP = EER/3.412 = 2.8COP$) and 66% of homes in Illinois having central cooling ("Table HC7.9 Air Conditioning in Homes in Midwest Region, Divisions, and States, 2009 from Energy Information Administration", 2009 Residential Energy Consumption Survey)

Bulb Location	WHFe
Multifamily in unit	1.04 ¹³¹⁰
Unknown location	1.054 ¹³¹¹

For example, a 0.3W LED nightlight is direct installed in single family interior location within ComEd territory:

$$\begin{aligned} \Delta\text{kWh} &= ((7 - 0.3) / 1000) * 0.969 * (1 - 0) * 4380 * 1.06 \\ &= 30.1 \text{ kWh} \end{aligned}$$

HEATING PENALTY

If electric heated home (if heating fuel is unknown assume gas, see Fossil Fuel section):

$$\Delta\text{kWh}^{1312} = - ((\text{WattsBase} - \text{WattsEE}) / 1000) * \text{ISR} * \text{Hours} * \text{HF} / \eta\text{Heat}$$

Where:=(

- HF = Heating Factor or percentage of light savings that must be heated
= 49% for interior¹³¹³
- ηHeat = Efficiency in COP of Heating equipment
= Actual. If not available use: ¹³¹⁴

System Type	Age of Equipment	HSPF2 Estimate	COP _{HEAT} (COP Estimate) = (HSPF2/3.413)*0.85
Heat Pump (if age unknown assume 2006-2014)	Before 2006	5.8	1.44
	After 2006 - 2014	6.5	1.62
	2015 on	7.0	1.74
Resistance	N/A	N/A	1.00
Unknown ¹³¹⁵	N/A	N/A	1.28

¹³¹⁰ As above but using estimate of 45% of multifamily buildings in Illinois having central cooling (based on data from “Table HC7.1 Air Conditioning in U.S. Homes, By Housing Unit Type, 2009” which is for the whole of the US, scaled to IL air conditioning prevalence compared to US average)

¹³¹¹ Unknown is based on statewide weighted average of 69% single family and 31% multifamily, based on IL data from 2009 RECS Table HC2.9 Structural and Geographic Characteristics of Homes in Midwest Region, Divisions and States, 2009.

¹³¹² Negative value because this is an increase in heating consumption due to the efficient lighting.

¹³¹³ This means that heating loads increase by 49% of the lighting savings. This is based on the average result from REMRate modeling of several different configurations and IL locations of homes.

¹³¹⁴ These default system efficiencies are based on the applicable minimum Federal Standards. In 2006 the Federal Standard for Heat Pumps was adjusted. While one would expect the average system efficiency to be higher than this minimum, the likely degradation of efficiencies over time mean that using the minimum standard is appropriate. Note efficiency should include duct losses. Defaults provided assume 15% duct loss for heat pumps.

¹³¹⁵ Calculation assumes 35% Heat Pump and 65% Resistance, which is based upon data from Energy Information Administration, 2009 Residential Energy Consumption Survey, see “HC6.9 Space Heating in Midwest Region.xls”, using average for East North Central Region. Average efficiency of heat pump is based on assumption that 50% are units from before 2006 and 50% from 2006-2014. Program or evaluation data should be used to improve this assumption if available.

For example, a 0.3W LED nightlight is direct installed in single family interior location with a 2016 heat pump:

$$\begin{aligned} \Delta\text{kWh} &= - (((7 - 0.3) / 1000) * 0.969 * (1-0) * 4380 * 0.49) / 2.04 \\ &= - 6.83 \text{ kWh} \end{aligned}$$

SUMMER COINCIDENT PEAK DEMAND SAVINGS

$$\Delta\text{kW} = ((\text{WattsBase} - \text{WattsEE}) / 1000) * \text{ISR} * (1 - \text{Leakage}) * \text{WHFd} * \text{CF}$$

Where:

WHFd = Waste heat factor for demand to account for cooling savings from efficient lighting.

Bulb Location	WHFd
Interior single family or unknown location	1.11 ¹³¹⁶
Multifamily in unit	1.07 ¹³¹⁷
Unknown location	1.098 ¹³¹⁸

CF = Summer Peak Coincidence Factor for measure.
= 0

FOSSIL FUEL SAVINGS

Heating penalty if Natural Gas heated home, or if heating fuel is unknown.

$$\Delta\text{therms} = - (((\text{WattsBase} - \text{WattsEE}) / 1000) * \text{ISR} * \text{Hours} * \text{HF} * 0.03412) / \eta\text{Heat}$$

Where:

HF = Heating factor, or percentage of lighting savings that must be replaced by heating system.
= 49% for interior¹³¹⁹

0.03412 = Converts kWh to Therms

ηHeat = Average heating system efficiency
= 0.70¹³²⁰

Other factors as defined above

¹³¹⁶ The value is estimated at 1.11 (calculated as 1 + (0.66 * 0.466 / 2.8)). See footnote relating to WHFe for details. Note the 46.6% factor represents the average Residential cooling coincidence factor calculated by dividing average load during the peak hours divided by the maximum cooling load.

¹³¹⁷ As above but using estimate of 45% of multifamily buildings in Illinois having central cooling (based on data from “Table HC7.1 Air Conditioning in U.S. Homes, By Housing Unit Type, 2009” which is for the whole of the US, scaled to IL air conditioning prevalence compared to US average)

¹³¹⁸ Unknown is based on statewide weighted average of 69% single family and 31% multifamily, based on IL data from 2009 RECS Table HC2.9 Structural and Geographic Characteristics of Homes in Midwest Region, Divisions and States, 2009.

¹³¹⁹ Average result from REMRate modeling of several different configurations and IL locations of homes

¹³²⁰ This has been estimated assuming that natural gas central furnace heating is typical for Illinois residences (66% of Illinois homes have a Natural Gas Furnace (based on Energy Information Administration, 2009 Residential Energy Consumption Survey) In 2000, 24% of furnaces purchased in Illinois were condensing (based on data from GAMA, provided to Department of Energy during the federal standard setting process for residential heating equipment - see Furnace Penetration.xls). Furnaces tend to last up to 20 years and so units purchased 10 years ago provide a reasonable proxy for the current mix of furnaces in the State. Assuming typical efficiencies for condensing and non-condensing furnaces and duct losses, the average heating system efficiency is estimated as follows:

$$(0.24 * 0.92) + (0.76 * 0.8) * (1 - 0.15) = 0.70$$

For example, a 0.3W LED nightlight is direct installed in single family interior location with gas heating at 70% total efficiency:

$$\begin{aligned}\Delta\text{therms} &= - ((7 - 0.3) / 1000) * 0.969 * (1-0) * 4380 * 0.49 * 0.03412 / 0.70 \\ &= - 0.68 \text{ therms}\end{aligned}$$

WATER IMPACT DESCRIPTIONS AND CALCULATION

N/A

MEASURE CODE: RS-LTG-NITL-V03-250101

REVIEW DEADLINE: 1/1/2028

5.5.12 Connected LED Lamps

DESCRIPTION

Many home devices in the market have become integrated with smart technology in recent years. Home devices able to connect to Wifi or a mobile network allow the user to control the device over the internet. This measure defines the savings associated with connected lighting. Connected LEDs allow for remote user control through a smart device, such as smart phone, tablet, or smart speaker. The standard LED provides light in one shade at one lumen level and color temperature. Connected LEDs have options integrated that allow for customizable color, color temperature, and lumen output. The Connected LED can also be turned on and off with a set schedule or controlled remotely. Savings from this measure come from both reduced hours of operation and dimming.

This measure was developed to be applicable to the following program types: TOS, NC

DEFINITION OF EFFICIENT EQUIPMENT

For this characterization to apply, the efficient condition must be LED lighting that is controlled by a smart device. The savings for this measure are the estimated incremental control savings compared to a non-connected efficient lamp. Some connected LEDs come with hubs for managing their operations. Connected LEDs with hubs do not qualify for this savings characterization, as the energy use by the hub cancels out the savings attributed to the connectivity of the lamp.

DEFINITION OF BASELINE EQUIPMENT

The baseline condition is the efficient LED without the connected capabilities.

DEEMED LIFETIME OF EFFICIENT EQUIPMENT

The deemed measure life is 6.1 years for exterior application.¹³²¹ For all other applications, lifetimes are capped at 10 years.¹³²²

DEEMED MEASURE COST

The incremental cost can be assumed to be \$20, the difference between the average cost of the baseline non-connected LED and the average cost of the connected LED.¹³²³

LOADSHAPE

Loadshape R06 – Residential Indoor Lighting

Loadshape R07 – Residential Outdoor Lighting

COINCIDENCE FACTOR

The summer peak coincidence factor is assumed to be 0.128 for Residential and in-unit Multi Family bulbs,¹³²⁴ 0.273

¹³²¹ ENERGY STAR v2.1 requires omnidirectional LED bulbs to be rated for at least 15,000 hours. 15000/2475 (exterior hours of use) = 6.1 years.

¹³²² Based on recommendation in the Dunsky Energy Consulting, Livingston Energy Innovations and Opinion Dynamics Corporation; NEEP Emerging Technology Research Report, p 6-18.

¹³²³ Estimate based on review of available product and estimates provided in King J., ACEEE, “Energy Impacts of Smart Home Technologies”, April 2018.

¹³²⁴ Based on the IL Statewide LED Lighting Logger study conducted as part of the PY8/PY9 evaluations of the Ameren Illinois and ComEd Residential Lighting programs.

for exterior bulbs,¹³²⁵ and 0.135 for unknown.¹³²⁶

Use Multifamily if: Building meets utility’s definition for multifamily.

Algorithm

CALCULATION OF ENERGY SAVINGS

ELECTRIC ENERGY SAVINGS

$$\Delta kWh = (((Watts_{EE}/1000) * HOURS * SVGe * WHFe) - Standby_{kWh}) * ISR * (1 - Leakage)$$

Where:

WattsEE = Actual wattage of LED. If unknown, then use defaults provided below.¹³²⁷

Minimum Lumens	Maximum Lumens	LED Wattage (WattsEE)
310	399	4.0
400	749	6.6
750	899	9.6
900	1,399	13.1
1,400	1,999	16.0
2,000	2,999	21.8
3,000	3,299	28.9

HOURS = Average hours of use per year

Installation Location	Hours
Residential and in-unit Multi Family	1,089 ¹³²⁸
Exterior	2,475 ¹³²⁹
Unknown	1,159 ¹³³⁰

SVGe = Percentage of annual lighting energy saved by lighting control; determined on a site-specific basis or using default below

¹³²⁵ Based on lighting logger study conducted as part of the PY5/6 ComEd Residential Lighting Program evaluation. the IL Statewide LED Lighting Logger study conducted as part of the PY8/PY9 evaluations of the Ameren Illinois and ComEd Residential Lighting programs was unable to provide coincidence factors for screw-based omnidirectional LEDs in exterior applications.

¹³²⁶ Based on a weighted average of coincidence factors in interior and exterior applications, assuming 5% exterior lighting. The distribution of LEDs is based on the on-site lighting inventory conducted as part of the IL Statewide LED Lighting Logger study.

¹³²⁷ See file “LED Lamp Updates 2021-06-09” for details on Guidehouse lamp wattage calculations based on equivalent baseline wattage and LED wattage of available ENERGY STAR product.

¹³²⁸ Based on the IL Statewide LED Lighting Logger study conducted as part of the PY8/PY9 evaluations of the Ameren Illinois and ComEd Residential Lighting programs.

¹³²⁹ Based on lighting logger study conducted as part of the PY5/6 ComEd Residential Lighting Program evaluation. The IL Statewide LED Lighting Logger study conducted as part of the PY8/PY9 evaluations of the Ameren Illinois and ComEd Residential Lighting programs was unable to provide hours of use for screw-based omnidirectional LEDs in exterior applications.

¹³³⁰ Based on a weighted average of hours of use in interior and exterior applications, assuming 5% exterior lighting. The distribution of LEDs is based on the on-site lighting inventory conducted as part of the IL Statewide LED Lighting Logger study.

= 0.37¹³³¹

ISR = In Service Rate, the percentage of lamps rebated that are actually in service.

Program		Weighted Average 1 st year In Service Rate (ISR) ¹³³²
Retail (Time of Sale)		98.0%
Direct Install		94.5%
Efficiency Kits	LED Distribution	83%
	School Kits	84%
	Direct Mail Kits	93%
	Direct Mail Kits, Income Qualified	95%
	Community Distributed Kits	95%
Food Bank / Pantry Distribution		98%

Leakage = Adjustment to account for the percentage of program bulbs that move out (and in if deemed appropriate)¹³³³ of the Utility Jurisdiction.

KITS programs = Determined through evaluation

Upstream (TOS) Lighting programs = Use deemed assumptions below:¹³³⁴

ComEd: 0.8%

Ameren: 13.1%

All other programs = 0

WHFe = Waste heat factor for energy to account for cooling savings

Bulb Location	WHFe
Interior single family	1.06 ¹³³⁵

¹³³¹ Based on Lockheed Martin, 'Home Energy Management System/Smart Lighting Pilot for National Grid's Massachusetts and Rhode Island Residential Energy Efficiency Programs', Final Report, March 18, 2019. The study found the energy consumption of the LED to be 11.5/1000 * 1200 hours = 13.8kWh. Savings from the smart lamp included both geo fencing (96% of studied homes providing 5.1kWh of savings) and in-room occupancy (3% of studied homes providing 6.6kWh of savings), for a total savings of 5.1kWh (0.96*5.1 + 0.03*6.6). As a percentage of the LED consumption this is 5.1/13.8 = 37%.

¹³³² ISRs are consistent with the LED Screw Based Standard Lamp measure, however since 2nd and 3rd year savings for this measure are so minimal, for ease of implementation the 3 year installs are discounted using the real discount rate to a single assumption.

¹³³³ Leakage in is only appropriate to credit to IL utility program savings if it is reasonably expected that the IL utility program marketing efforts played an important role in influencing customer to purchase the light bulbs. Furthermore, consideration that such customers might be free riders should be addressed. If leakage in is assessed, efforts should be made to ensure no double counting of savings occurs if the evaluation is estimating both leakage in and spillover savings of light bulbs.

¹³³⁴ Leakage rate is based upon review of PY8-CY2018 evaluations from ComEd and PY8 for Ameren.

¹³³⁵ The value is estimated at 1.06 (calculated as 1 + (0.66*(0.27 / 2.8)). Based on cooling loads decreasing by 27% of the lighting savings (average result from REMRate modeling of several different configurations and IL locations of homes), assuming typical cooling system operating efficiency of 2.8 COP (starting from standard assumption of SEER 10.5 central AC unit, converted to 9.5 EER using algorithm (-0.02 * SEER2) + (1.12 * SEER) (from Wassmer, M. (2003). A Component-Based Model for Residential Air Conditioner and Heat Pump Energy Calculations. Masters Thesis, University of Colorado at Boulder), converted to COP = EER/3.412 = 2.8COP) and 66% of homes in Illinois having central cooling ("Table HC7.9 Air Conditioning in Homes in Midwest Region, Divisions, and States, 2009 from Energy Information Administration", 2009 Residential Energy Consumption Survey)

Bulb Location	WHFe
Multifamily in unit	1.04 ¹³³⁶
Exterior or uncooled location	1.0
Unknown location	1.051 ¹³³⁷

StandbykWh = Standby power draw of the controlled lamp. Use actual value from manufacturer specification. If not known then assume:
 = 0.63 kWh¹³³⁸

For example, a 9W Connected LED is purchased through a ComEd upstream program.

$$\Delta kWh_{1st\ year\ installs} = (((9/1000) * 1,089 * 0.37 * 1.051) - 0.63) * 0.9 * (1 - 0.008)$$

$$= 2.84\ kWh$$

HEATING PENALTY

If electric heated home (if heating fuel is unknown assume gas, see Fossil Fuel section):

$$\Delta kWh^{1339} = - (((WattsBase - WattsEE) / 1000) * ISR * Hours * HF) / \eta_{Heat}$$

Where:

- HF = Heating Factor or percentage of light savings that must be heated
 = 49% for interior¹³⁴⁰
- η_{Heat} = Efficiency in COP of Heating equipment
 = Actual. If not available use: ¹³⁴¹

System Type	Age of Equipment	HSPF2 Estimate	COP _{HEAT} (COP Estimate) = (HSPF2/3.413)*0.85
Heat Pump (if age unknown assume 2006-2014)	Before 2006	5.8	1.44
	After 2006 - 2014	6.5	1.62
	2015 on	7.0	1.74
Resistance	N/A	N/A	1.00
Unknown ¹³⁴²	N/A	N/A	1.28

¹³³⁶ As above but using estimate of 45% of multifamily buildings in Illinois having central cooling (based on data from “Table HC7.1 Air Conditioning in U.S. Homes, By Housing Unit Type, 2009” which is for the whole of the US, scaled to IL air conditioning prevalence compared to US average)

¹³³⁷ Unknown is weighted average of interior v exterior (assuming 5% exterior lighting based on distribution of LEDs from on-site lighting inventory conducted as part of the IL Statewide LED Lighting Logger study) and SF v MF interior based on statewide weighted average of 69% single family and 31% multifamily, based on IL data from 2009 RECS Table HC2.9 Structural and Geographic Characteristics of Homes in Midwest Region, Divisions and States, 2009.

¹³³⁸ Based on Lockheed Martin, ‘Home Energy Management System/Cmart Lighting Pilot for National Grid’s Massachusetts and Rhode Island Residential Energy Efficiency Programs’, Final Report, March 18, 2019.

¹³³⁹ Negative value because this is an increase in heating consumption due to the efficient lighting.

¹³⁴⁰ This means that heating loads increase by 49% of the lighting savings. This is based on the average result from REMRate modeling of several different configurations and IL locations of homes.

¹³⁴¹ These default system efficiencies are based on the applicable minimum Federal Standards. In 2006 the Federal Standard for Heat Pumps was adjusted. While one would expect the average system efficiency to be higher than this minimum, the likely degradation of efficiencies over time mean that using the minimum standard is appropriate. Note efficiency should include duct losses. Defaults provided assume 15% duct loss for heat pumps.

¹³⁴² Calculation assumes 35% Heat Pump and 65% Resistance, which is based upon data from Energy Information Administration,

SUMMER COINCIDENT PEAK DEMAND SAVINGS

$$\Delta kWh = (\text{Watts}_{\text{SE}}/1000) * \text{SVGd} * \text{WHFd} * \text{ISR} * (1 - \text{Leakage}) * \text{CF}$$

Where:

SVGd = Percentage of annual lighting demand saved by lighting control; determined on a site-specific basis or using default below
 = 0.37¹³⁴³

WHFd = Waste heat factor for demand to account for cooling savings from efficient lighting.

Bulb Location	WHFd
Interior single family	1.11 ¹³⁴⁴
Multifamily in unit	1.07 ¹³⁴⁵
Exterior or uncooled location	1.0
Unknown location	1.093 ¹³⁴⁶

CF = Summer Peak Coincidence Factor for measure.

Bulb Location	CF
Interior	0.128 ¹³⁴⁷
Exterior	0.273 ¹³⁴⁸
Unknown	0.135 ¹³⁴⁹

For example, a 9W Connected LED is purchased through a ComEd upstream program.

$$\begin{aligned} \Delta kW_{\text{1st year installs}} &= (((9/1000) * 0.37 * 1.093)) * 0.9 * (1 - 0.008) \\ &= 0.0032 \text{ kW} \end{aligned}$$

FOSSIL FUEL SAVINGS

Heating penalty if Natural Gas heated home, or if heating fuel is unknown.

2009 Residential Energy Consumption Survey, see “HC6.9 Space Heating in Midwest Region.xls”, using average for East North Central Region. Average efficiency of heat pump is based on assumption that 50% are units from before 2006 and 50% from 2006-2014. Program or evaluation data should be used to improve this assumption if available.

¹³⁴³ Assumed equal to SVGe.

¹³⁴⁴ The value is estimated at 1.11 (calculated as 1 + (0.66 * 0.466 / 2.8)). See footnote relating to WHFe for details. Note the 46.6% factor represents the average Residential cooling coincidence factor calculated by dividing average load during the peak hours divided by the maximum cooling load.

¹³⁴⁵ As above but using estimate of 45% of multifamily buildings in Illinois having central cooling (based on data from “Table HC7.1 Air Conditioning in U.S. Homes, By Housing Unit Type, 2009” which is for the whole of the US, scaled to IL air conditioning prevalence compared to US average)

¹³⁴⁶ Unknown is weighted average of interior v exterior (assuming 5% exterior lighting based on distribution of LEDs from on-site lighting inventory conducted as part of the IL Statewide LED Lighting Logger study) and SF v MF interior based on statewide weighted average of 69% single family and 31% multifamily, based on IL data from 2009 RECS Table HC2.9 Structural and Geographic Characteristics of Homes in Midwest Region, Divisions and States, 2009.

¹³⁴⁷ Based on the IL Statewide LED Lighting Logger study conducted as part of the PY8/PY9 evaluations of the Ameren Illinois and ComEd Residential Lighting programs.

¹³⁴⁸ Based on lighting logger study conducted as part of the PY5/6 ComEd Residential Lighting Program evaluation. the IL Statewide LED Lighting Logger study conducted as part of the PY8/PY9 evaluations of the Ameren Illinois and ComEd Residential Lighting programs was unable to provide coincidence factors for screw-based omnidirectional LEDs in exterior applications.

¹³⁴⁹ Based on a weighted average of coincidence factors in interior and exterior applications, assuming 5% exterior lighting. The distribution of LEDs is based on the on-site lighting inventory conducted as part of the IL Statewide LED Lighting Logger study.

$$\Delta \text{therms} = - \left(\frac{\text{WattsBase} - \text{WattsEE}}{1000} \right) * \text{ISR} * \text{Hours} * \text{HF} * 0.03412 / \eta_{\text{Heat}}$$

Where:

HF = Heating factor, or percentage of lighting savings that must be replaced by heating system.

= 49% for interior¹³⁵⁰

0.03412 = Converts kWh to Therms

η_{Heat} = Average heating system efficiency

= 0.70¹³⁵¹

Other factors as defined above

WATER AND OTHER NON-ENERGY IMPACT DESCRIPTIONS AND CALCULATION

NA

DEEMED O&M COST ADJUSTMENT CALCULATION

NA

MEASURE CODE: RS-LTG-LEDC-V04-250101

REVIEW DEADLINE: 1/1/2026

¹³⁵⁰ Average result from REMRate modeling of several different configurations and IL locations of homes

¹³⁵¹ This has been estimated assuming that natural gas central furnace heating is typical for Illinois residences (66% of Illinois homes have a Natural Gas Furnace (based on Energy Information Administration, 2009 Residential Energy Consumption Survey) In 2000, 24% of furnaces purchased in Illinois were condensing (based on data from GAMA, provided to Department of Energy during the federal standard setting process for residential heating equipment - see Furnace Penetration.xls). Furnaces tend to last up to 20 years and so units purchased 10 years ago provide a reasonable proxy for the current mix of furnaces in the State. Assuming typical efficiencies for condensing and non-condensing furnaces and duct losses, the average heating system efficiency is estimated as follows:

$$(0.24 * 0.92) + (0.76 * 0.8) * (1 - 0.15) = 0.70$$

5.5.13 EISA Exempt LED Lighting

DESCRIPTION

This characterization provides savings assumptions for LED lamps and fixture types that are exempt from the EISA legislation. This characterization assumes that the LED lamp is installed in a residential location. Where the implementation strategy does not allow for the installation location to be known (e.g., an upstream retail program) a deemed split of 97% Residential and 3% Commercial assumptions should be used.¹³⁵²

This measure was developed to be applicable to the following program types: TOS, NC, EREP, DI, KITS.

If applied to other program types, the measure savings should be verified.

DEFINITION OF EFFICIENT EQUIPMENT

In order for this characterization to apply, new lamps must be ENERGY STAR labeled or equivalent to the most recent version of ENERGY STAR specifications or be listed on the Design Lights Consortium Qualifying Product List. Note a new ENERGY STAR specification v2.1 became effective on 1/2/2017.

DEFINITION OF BASELINE EQUIPMENT

This measure is only for lamp and fixture types that are exempt from EISA, including lamps with an initial lumen output of less than 310 lumens, with initial lumen output greater than 3,300 lumens, and Task/Undercabinet Fixtures with a linear fluorescent baseline.

DEEMED LIFETIME OF EFFICIENT EQUIPMENT

The average rated life for lamps on the ENERGY STAR Qualified Products list (accessed 6/16/2020) is approximately 20,000 hours for omnidirectional lamps, 17,000 hours for decorative lamps and 25,000 for directional lamps. The deemed measure life is 8 years for exterior omnidirectional lamps and 6.9 years for exterior decorative lamps and lifetimes are capped at 10 years for other applications.¹³⁵³ For early replacement measures, if replacing a halogen or incandescent bulb, the remaining life is assumed to be 333 hours. For CFL's, the remaining life is 3,333 hours.¹³⁵⁴

The rated life of linear task and under cabinet fixtures is 45,000 hours¹³⁵⁵ and for T-LEDS is 50,000 hours. However, all fixture lifetimes are capped at 15 years.¹³⁵⁶

DEEMED MEASURE COST

The price of LED lamps is falling quickly. Where possible, the actual LED lamp cost should be used and compared to the baseline cost provided below. If the incremental cost is unknown, assume the following:

Type	Incremental Cost
Omni-directional A-Lamps	\$1.45 ¹³⁵⁷
Decorative	\$1.66

¹³⁵² RES v C&I split is based on a weighted (by sales volume) average of ComEd PY8, PY9 and CY2018 and Ameren PY8 in store intercept survey results. See 'RESvCI Split_2019.xlsx'.

¹³⁵³ Based on recommendation in the Dunsy Energy Consulting, Livingston Energy Innovations and Opinion Dynamics Corporation; NEEP Emerging Technology Research Report, p 6-18.

¹³⁵⁴ Representing a third of the expected lamp lifetime.

¹³⁵⁵ Average rated lives are based on the average rated lives of fixtures available on the ENERGY STAR qualifying list as of 2/26/2018.

¹³⁵⁶ Based on recommendation in the Dunsy Energy Consulting, Livingston Energy Innovations and Opinion Dynamics Corporation; NEEP Emerging Technology Research Report, p 6-18.

¹³⁵⁷ Baseline and LED lamp costs are based on field data collected by CLEAResult and provided by ComEd. See ComEd Pricing Projections 06302016.xlsx for analysis.

Type	Incremental Cost
Directional	\$1.65
Linear Task/Under Cabinet	\$18 ¹³⁵⁸
T-LEDs	\$13 ¹³⁵⁹

LOADSHAPE

Loadshape R06 – Residential Indoor Lighting

Loadshape R07 – Residential Outdoor Lighting

COINCIDENCE FACTOR

The summer peak coincidence factor is assumed to be 0.128 for Residential and in-unit Multi Family bulbs,¹³⁶⁰ 0.273 for exterior bulbs,¹³⁶¹ and 0.135 for unknown,¹³⁶²

Use Multifamily if: Building meets utility’s definition for multifamily.

Algorithm

CALCULATION OF SAVINGS

ELECTRIC ENERGY SAVINGS

$$\Delta kWh = ((Watts_{base} - Watts_{EE}) / 1000) * ISR * (1 - Leakage) * Hours * WHF_e$$

Where:

Watts_{base} = Input wattage of the existing or baseline system. Reference the “LED New and Baseline Assumptions” table for default values.

Watts_{EE} = Actual wattage of LED purchased / installed. If unknown, use default provided below.¹³⁶³

LED New and Baseline Assumptions Table

¹³⁵⁸ Incremental costs for task/under cabinet and downlight fixtures are from the 2018 Michigan Energy Measures Database.

¹³⁵⁹ Consistent with measure 4.5.4 LED Bulbs and Fixtures in Volume 2.

¹³⁶⁰ Based on the IL Statewide LED Lighting Logger study conducted as part of the PY8/PY9 evaluations of the Ameren Illinois and ComEd Residential Lighting programs.

¹³⁶¹ Based on lighting logger study conducted as part of the PY5/6 ComEd Residential Lighting Program evaluation. the IL Statewide LED Lighting Logger study conducted as part of the PY8/PY9 evaluations of the Ameren Illinois and ComEd Residential Lighting programs was unable to provide coincidence factors for screw-based omnidirectional LEDs in exterior applications.

¹³⁶² Based on a weighted average of coincidence factors in interior and exterior applications, assuming 5% exterior lighting. The distribution of LEDs is based on the on-site lighting inventory conducted as part of the IL Statewide LED Lighting Logger study.

¹³⁶³ See file “LED Lamp Updates 2021-06-09” for details on Guidehouse lamp wattage calculations based on equivalent baseline wattage and LED wattage of available ENERGY STAR product.

Type		Minimum Lumens	Maximum Lumens	LED Wattage (WattsEE)	Baseline (WattsBase)	Delta Watts
A-Lamps		120	309	4.0	25	21.0
		3,300	3,999	28.9	200	171.1
		4,000	5,000	35.7	300	264.3
Decorative	Globe (medium and intermediate bases less than 750 lumens)	150	309	3.0	25	22
	Globe (candelabra bases less than 1050 lumens)	150	309	3.5	25	21.5
	Decorative (Shapes B, BA, C, CA, DC, F, G, medium and intermediate bases less than 750 lumens)	160	299	2.6	25	22.4
		300	309	4.3	40	35.7
	Decorative (Shapes B, BA, C, CA, DC, F, G, candelabra bases less than 1050 lumens)	120	159	1.5	15	13.5
		160	299	2.7	25	22.3
		300	309	4.2	40	35.8
	Decorative (Shape ST)	250	309	6.5	40	33.5
	Decorative (Shape S)	50	75	1.0	11	10.0
		100	120	1.2	15	13.8
120		309	2.25	25	22.8	
Directional	Reflector lamp types with medium screw bases (PAR20, PAR30(S,L), PAR38, R40, etc.) w/ diameter >2.25"	3,300	4,200	27.3	250	222.7
	Reflector lamp types with medium screw bases (PAR16, R14, R16, etc.) w/ diameter <2.25" (*see exceptions below)	280	309	4.6	35	30.4
	*MR16	250	309	3.8	20.0	16.2
Linear Task/Under Cabinet		All		11.6	45.2	33.6
T-LEDs		0	1,199	8.9	15	6.1
		1,200	2,399	15.8	28.2	12.4
		2,400		22.9	41.8	18.9

ISR = In Service Rate, the percentage of lamps rebated that are actually in service.

Program		In Service Rate (ISR) ¹³⁶⁴
Retail (Time of Sale)		97.9% ¹³⁶⁵
Direct Install		94.5% ¹³⁶⁶
Virtual Assessment followed by Unverified Self-Install		97.9% ¹³⁶⁷
Efficiency Kits ¹³⁶⁸	LED Distribution ¹³⁶⁹	82.8%
	School Kits ¹³⁷⁰	83.8%
	Direct Mail Kits ¹³⁷¹	91.8%
	Direct Mail Kits, Income Qualified ¹³⁷²	60%
	Community Distributed Kits ¹³⁷³	95.0%
Food Bank / Pantry Distribution ¹³⁷⁴		97.9% ¹³⁷⁵

Leakage = Adjustment to account for the percentage of program bulbs that move out (and in if deemed appropriate)¹³⁷⁶ of the Utility Jurisdiction.

¹³⁶⁴ In Service Rates now represent the lifetime In Service Rates with the second and third year installations discounted by the Real Discount Rate of 0.46%. Lifetime ISR assumptions for efficiency kits are based upon comparing with CFL Distribution First year ISR and multiplying by the CFL Distribution Final ISR value, capped at 95%, and second and third year estimates based on same proportion of future installs. For all other programs the 98% Lifetime ISR assumption is based upon the standard CFL measure in the absence of any better reference. This value is based upon review of two evaluations:

‘Nexus Market Research, RLW Analytics and GDS Associates study; ‘New England Residential Lighting Markdown Impact Evaluation, January 20, 2009’ and ‘KEMA Inc, Feb 2010, Final Evaluation Report; Upstream Lighting Program, Volume 1.’ This implies that only 2% of bulbs purchased are never installed. The second and third year installations are based upon Ameren analysis of the Californian KEMA study showing that 54% of future installs occur in year 2 and 46% in year 3.

¹³⁶⁵ 1st year in service rate is based upon analysis of ComEd PY8, PY9 and CY2018 and Ameren PY8 intercept data (see ‘RES Lighting ISR_2019.xlsx’ for more information).

¹³⁶⁶ Based upon average of Navigant low income single family direct install field work LED ISR and Standard CFL assumption in the absence of better data, and is based upon review of the PY2 and PY3 ComEd Direct Install program surveys. This value includes bulb failures in the 1st year to be consistent with the Commission approval of annualization of savings for first year savings claims. ComEd PY2 All Electric Single Family Home Energy Performance Tune-Up Program Evaluation, Navigant Consulting, December 21, 2010.

¹³⁶⁷ An equal weighted average of Direct Install and Direct Mail Kit ISRs. Interest and applicability of measures confirmed through virtual assessment.

¹³⁶⁸ In Service Rates provided are for the bulb within a kit only. Given the significant differences in program design and the level of education provided through Efficiency Kits programs, the evaluators should apply the ISR estimated through evaluations (either past evaluations or the current program year evaluation) of the specific Efficiency Kits program. In cases where program-specific evaluation results for an ISR are unavailable, the default ISR values for Efficiency Kits provide may be used.

¹³⁶⁹ Free bulbs provided without request, with little or no education. Consistent with Standard CFL assumptions.

¹³⁷⁰ 1st year ISR for school kits based on ComEd PY9 data for the Elementary Energy Education program. Final ISR assumptions are based upon comparing with CFL Distribution First year ISR and multiplying by the CFL Distribution Final ISR value, and second and third year estimates based on same proportion of future installs.

¹³⁷¹ Opt-in program to receive kits via mail, with little or no education. Consistent with Standard CFL assumptions.

¹³⁷² Research from 2021 Ameren Illinois Income Qualified participant survey (customer self-report), available on IL SAG website: <https://ilsag.s3.amazonaws.com/AIC-Income-Qualified-Initiative-Participant-Survey-Results-Memo-FINAL-2022-02-01.pdf>

¹³⁷³ Kits distributed in a community setting, targeted to income qualified communities. Research from 2018 Ameren Illinois Income Qualified participant survey.

¹³⁷⁴ Free bulbs provided through local food banks and food pantries.

¹³⁷⁵ 1st year ISR is determined based on online surveys conducted for ComEd CY2018 Food Bank LED Distribution program. See ‘CY2018 ComEd Foodbank LED Dist Survey Results_Navigant’.

¹³⁷⁶ Leakage in is only appropriate to credit to IL utility program savings if it is reasonably expected that the IL utility program marketing efforts played an important role in influencing customer to purchase the light bulbs. Furthermore, consideration that such customers might be free riders should be addressed. If leakage in is assessed, efforts should be made to ensure no double counting of savings occurs if the evaluation is estimating both leakage in and spillover savings of light bulbs.

KITS programs = Determined through evaluation

Upstream (TOS) Lighting programs = Use deemed assumptions below:¹³⁷⁷

ComEd: 0.8%
Ameren: 13.1%

All other programs = 0

Hours = Average hours of use per year

Type	Installation Location	Hours
Omnidirectional A-Lamps	Residential and in-unit Multi Family	1,089 ¹³⁷⁸
	Exterior	2,475 ¹³⁷⁹
	Unknown	1,159 ¹³⁸⁰
Decorative and Directional Lamps	Residential and In-Unit Multi Family	763 ¹³⁸¹
	Exterior	2,475 ¹³⁸²
	Unknown	1,020 ¹³⁸³
Linear Task/Under Cabinet	All	730 ¹³⁸⁴
T-LEDs	All	730 ¹³⁸⁵

WHFe = Waste heat factor for energy to account for cooling energy savings from efficient lighting

Bulb Location	WHFe
Interior single family	1.06 ¹³⁸⁶
Multifamily in unit	1.04 ¹³⁸⁷

¹³⁷⁷ Leakage rate is based upon review of PY8-CY2018 evaluations from ComEd and PY8 for Ameren.

¹³⁷⁸ Based on the IL Statewide LED Lighting Logger study conducted as part of the PY8/PY9 evaluations of the Ameren Illinois and ComEd Residential Lighting programs.

¹³⁷⁹ Based on lighting logger study conducted as part of the PY5/6 ComEd Residential Lighting Program evaluation. The IL Statewide LED Lighting Logger study conducted as part of the PY8/PY9 evaluations of the Ameren Illinois and ComEd Residential Lighting programs was unable to provide hours of use for screw-based omnidirectional LEDs in exterior applications.

¹³⁸⁰ Based on a weighted average of hours of use in interior and exterior applications, assuming 5% exterior lighting. The distribution of LEDs is based on the on-site lighting inventory conducted as part of the IL Statewide LED Lighting Logger study.

¹³⁸¹ Based on the IL Statewide LED Lighting Logger study conducted as part of the PY8/PY9 evaluations of the Ameren Illinois and ComEd Residential Lighting programs.

¹³⁸² Based on lighting logger study conducted as part of the PY5/6 ComEd Residential Lighting Program evaluation. The IL Statewide LED Lighting Logger study conducted as part of the PY8/PY9 evaluations of the Ameren Illinois and ComEd Residential Lighting programs was unable to provide hours of use for specialty LEDs in exterior applications.

¹³⁸³ Based on a weighted average of interior and exterior hours of use from the IL Statewide LED Lighting Logger study conducted as part of the PY8/PY9 evaluations of the Ameren Illinois and ComEd Residential Lighting programs, assuming 15% exterior specialty lighting. The distribution of LEDs is based on the on-site lighting inventory conducted as part of the IL Statewide LED Lighting Logger study.

¹³⁸⁴ Task/under cabinet hours of use are estimated at 2 hours per day.

¹³⁸⁵ Consistent with Linear Task/Under Cabinet assumption.

¹³⁸⁶ The value is estimated at 1.06 (calculated as $1 + (0.66 * (0.27 / 2.8))$). Based on cooling loads decreasing by 27% of the lighting savings (average result from REMRate modeling of several different configurations and IL locations of homes), assuming typical cooling system operating efficiency of 2.8 COP (starting from standard assumption of SEER 10.5 central AC unit, converted to 9.5 EER using algorithm $(-0.02 * SEER2) + (1.12 * SEER)$ (from Wassmer, M. (2003). A Component-Based Model for Residential Air Conditioner and Heat Pump Energy Calculations. Masters Thesis, University of Colorado at Boulder), converted to $COP = EER/3.412 = 2.8COP$) and 66% of homes in Illinois having central cooling ("Table HC7.9 Air Conditioning in Homes in Midwest Region, Divisions, and States, 2009 from Energy Information Administration", 2009 Residential Energy Consumption Survey)

¹³⁸⁷ As above but using estimate of 45% of multifamily buildings in Illinois having central cooling (based on data from "Table

Bulb Location	WHFe
Exterior or uncooled location	1.0
Unknown location	1.051 ¹³⁸⁸

For example, an 4W LED lamp, 300 lumens, is installed in the interior of a home. The customer purchased the lamp through a ComEd upstream program:

$$\begin{aligned} \Delta\text{kWh} &= ((25.0 - 4) / 1000) * 0.784 * (1 - 0.008) * 1,089 * 1.06 \\ &= 18.9 \text{ kWh} \end{aligned}$$

HEATING PENALTY

If electric heated home (if heating fuel is unknown assume gas, see Fossil Fuel section):

$$\Delta\text{kWh}^{1389} = - (((\text{WattsBase} - \text{WattsEE}) / 1000) * \text{ISR} * (1 - \text{Leakage}) * \text{Hours} * \text{HF}) / \eta\text{Heat}$$

Where:

- HF = Heating Factor or percentage of light savings that must be heated
 = 49% for interior¹³⁹⁰
 = 0% for exterior or unheated location
 = 42% for unknown location¹³⁹¹
- ηHeat = Efficiency in COP of Heating equipment
 = actual. If not available use:¹³⁹²

System Type	Age of Equipment	HSPF2 Estimate	COP _{HEAT} (COP Estimate) = (HSPF2/3.413)*0.85
Heat Pump (if age unknown assume 2006-2014)	Before 2006	5.8	1.44
	After 2006 - 2014	6.5	1.62
	2015 on	7.0	1.74
Resistance	N/A	N/A	1.00

HC7.1 Air Conditioning in U.S. Homes, By Housing Unit Type, 2009” which is for the whole of the US, scaled to IL air conditioning prevalence compared to US average)

¹³⁸⁸ Unknown is weighted average of interior v exterior (assuming 5% exterior lighting based on distribution of LEDs from on-site lighting inventory conducted as part of the IL Statewide LED Lighting Logger study) and SF v MF interior based on statewide weighted average of 69% single family and 31% multifamily, based on IL data from 2009 RECS Table HC2.9 Structural and Geographic Characteristics of Homes in Midwest Region, Divisions and States, 2009.

¹³⁸⁹ Negative value because this is an increase in heating consumption due to the efficient lighting.

¹³⁹⁰ This means that heating loads increase by 49% of the lighting savings. This is based on the average result from REMRate modeling of several different configurations and IL locations of homes.

¹³⁹¹ Based on a weighted average of interior and exterior hours of use from the IL Statewide LED Lighting Logger study conducted as part of the PY8/PY9 evaluations of the Ameren Illinois and ComEd Residential Lighting programs, assuming 15% exterior specialty lighting. The distribution of LEDs is based on the on-site lighting inventory conducted as part of the IL Statewide LED Lighting Logger study.

¹³⁹² These default system efficiencies are based on the applicable minimum Federal Standards. In 2006 the Federal Standard for Heat Pumps was adjusted. While one would expect the average system efficiency to be higher than this minimum, the likely degradation of efficiencies over time mean that using the minimum standard is appropriate. Note efficiency should include duct losses. Defaults provided assume 15% duct loss for heat pumps.

System Type	Age of Equipment	HSPF2 Estimate	COP _{HEAT} (COP Estimate) = (HSPF2/3.413)*0.85
Unknown ¹³⁹³	N/A	N/A	1.28

For example: using the same 4W LED that is installed in home with 2.0 COP Heat Pump (including duct loss) through a ComEd upstream program:

$$\Delta kWh_{1st\ year} = - ((25 - 4) / 1000) * 0.784 * (1-0.008) * 1,089 * 0.42) / 2.0$$

$$= - 3.7\ kWh$$

Second and third year install savings should be calculated using the appropriate ISR and the delta watts and hours from the install year.

SUMMER COINCIDENT PEAK DEMAND SAVINGS

$$\Delta kW = ((WattsBase - WattsEE) / 1000) * ISR * (1-Leakage) * WHFd * CF$$

Where:

WHFd = Waste heat factor for demand to account for cooling savings from efficient lighting.

Bulb Location	WHFd
Interior single family	1.11 ¹³⁹⁴
Multifamily in unit	1.07 ¹³⁹⁵
Exterior or uncooled location	1.0
Unknown location	1.093 ¹³⁹⁶

CF = Summer Peak Coincidence Factor for measure.

Bulb Location	CF
Interior	0.128 ¹³⁹⁷
Exterior	0.273 ¹³⁹⁸
Unknown	0.135 ¹³⁹⁹

¹³⁹³ Calculation assumes 35% Heat Pump and 65% Resistance, which is based upon data from Energy Information Administration, 2009 Residential Energy Consumption Survey, see “HC6.9 Space Heating in Midwest Region.xls”, using average for East North Central Region. Average efficiency of heat pump is based on assumption that 50% are units from before 2006 and 50% from 2006-2014. Program or evaluation data should be used to improve this assumption if available.

¹³⁹⁴ The value is estimated at 1.11 (calculated as 1 + (0.66 * 0.466 / 2.8)). See footnote relating to WHFe for details. Note the 46.6% factor represents the average Residential cooling coincidence factor calculated by dividing average load during the peak hours divided by the maximum cooling load.

¹³⁹⁵ As above but using estimate of 45% of multifamily buildings in Illinois having central cooling (based on data from “Table HC7.1 Air Conditioning in U.S. Homes, By Housing Unit Type, 2009” which is for the whole of the US, scaled to IL air conditioning prevalence compared to US average)

¹³⁹⁶ Unknown is weighted average of interior v exterior (assuming 5% exterior lighting based on distribution of LEDs from on-site lighting inventory conducted as part of the IL Statewide LED Lighting Logger study) and SF v MF interior based on statewide weighted average of 69% single family and 31% multifamily, based on IL data from 2009 RECS Table HC2.9 Structural and Geographic Characteristics of Homes in Midwest Region, Divisions and States, 2009.

¹³⁹⁷ Based on the IL Statewide LED Lighting Logger study conducted as part of the PY8/PY9 evaluations of the Ameren Illinois and ComEd Residential Lighting programs.

¹³⁹⁸ Based on lighting logger study conducted as part of the PY5/6 ComEd Residential Lighting Program evaluation. the IL Statewide LED Lighting Logger study conducted as part of the PY8/PY9 evaluations of the Ameren Illinois and ComEd Residential Lighting programs was unable to provide coincidence factors for screw-based omnidirectional LEDs in exterior applications.

¹³⁹⁹ Based on a weighted average of coincidence factors in interior and exterior applications, assuming 5% exterior lighting. The distribution of LEDs is based on the on-site lighting inventory conducted as part of the IL Statewide LED Lighting Logger study.

Other factors as defined above

For example: for the same 4W LED that is installed in a single family interior location through a ComEd upstream program:

$$\begin{aligned} \Delta kW &= ((25 - 4) / 1000) * 0.784 * (1-0.008) * 1.11 * 0.128 \\ &= 0.0023 \text{ kW} \end{aligned}$$

Second and third year install savings should be calculated using the appropriate ISR and the delta watts and hours from the install year.

FOSSIL FUEL SAVINGS

Heating penalty if Natural Gas heated home, or if heating fuel is unknown.

$$\Delta \text{Therms} = - (((\text{WattsBase} - \text{WattsEE}) / 1000) * \text{ISR} * (1 - \text{Leakage}) * \text{Hours} * \text{HF} * 0.03412) / \eta \text{Heat}$$

Where:

- HF = Heating factor, or percentage of lighting savings that must be replaced by heating system.
 - = 49% for interior¹⁴⁰⁰
 - = 0% for exterior location
 - = 42% for unknown location¹⁴⁰¹
- 0.03412 = Converts kWh to Therms
- η Heat = Average heating system efficiency.
 - = 0.70¹⁴⁰²

WATER IMPACT DESCRIPTIONS AND CALCULATION

N/A

DEEMED O&M COST ADJUSTMENT CALCULATION

For Omni-directional A-lamps, the baseline lamp is assumed to need replacing after 1000 hours. Therefore a baseline cost of \$1.25 should be applied every 0.92 years for interior applications, 0.40 years for exterior applications and 0.86 years for unknown.

For Decorative a baseline cost of \$1.74 should be applied every 0.92 years for interior applications, 0.40 years for exterior applications and 0.86 years for unknown.

¹⁴⁰⁰ Average result from REMRate modeling of several different configurations and IL locations of homes

¹⁴⁰¹ Based on a weighted average of interior and exterior hours of use from the IL Statewide LED Lighting Logger study conducted as part of the PY8/PY9 evaluations of the Ameren Illinois and ComEd Residential Lighting programs, assuming 15% exterior specialty lighting. The distribution of LEDs is based on the on-site lighting inventory conducted as part of the IL Statewide LED Lighting Logger study.

¹⁴⁰² This has been estimated assuming that natural gas central furnace heating is typical for Illinois residences (66% of Illinois homes have a Natural Gas Furnace (based on Energy Information Administration, 2009 Residential Energy Consumption Survey) In 2000, 24% of furnaces purchased in Illinois were condensing (based on data from GAMA, provided to Department of Energy during the federal standard setting process for residential heating equipment - see Furnace Penetration.xls). Furnaces tend to last up to 20 years and so units purchased 10 years ago provide a reasonable proxy for the current mix of furnaces in the State. Assuming typical efficiencies for condensing and non-condensing furnaces and duct losses, the average heating system efficiency is estimated as follows:

$$(0.24 * 0.92) + (0.76 * 0.8) * (1 - 0.15) = 0.70$$

For Directional a baseline cost of \$3.53 should be applied every 0.92 years for interior applications, 0.40 years for exterior applications and 0.86 years for unknown.

For Linear Task/Under Cabinet and T-LEDs, with a linear fluorescent baseline, there is assumed no O&M impact since the baseline lamp life is 18,000 – 30,000 hours and which is longer than the assumed measure life.

It is important to note that for cost-effectiveness screening purposes, the O&M cost adjustments should only be applied in cases where the light bulbs area actually in service and so should be multiplied by the appropriate ISR.

MEASURE CODE: RS-LTG-LEDE-V3-240101

REVIEW DEADLINE: 1/1/2028

5.5.14 Ultra-Efficient LED Lighting

DESCRIPTION

This characterization provides savings assumptions for a variety of ultra-efficient LED screw-based lamp types including omnidirectional and specialty (globe, decorative and downlights) types. This characterization assumes that the LED lamp is installed in a residential location. Where the implementation strategy does not allow for the installation location to be known (e.g., an upstream retail program not in a store ‘easily accessed by income qualified communities’ (see discussion below)) a deemed split of 97% Residential and 3% Commercial assumptions should be used.

Income Qualified Programs should not use this measure, but should continue to follow the dedicated guidance found in TRM sections 5.5.6 and 5.5.8 through 2025.

This measure was developed to be applicable to the following program types: TOS. If applied to other program types, the measure savings should be verified.

DEFINITION OF EFFICIENT EQUIPMENT

In order for this characterization to apply, new lamps must exceed efficiency specifications defined in the Standard-Efficiency LED Baseline Wattage Tables below. Consult the tables to find the *maximum* wattage that can be considered ultra-efficient for each bulb type.

Actual lamp wattages of the efficient equipment should be used to determine savings.

DEFINITION OF BASELINE EQUIPMENT

This TRM assumes that as of 6/30/2023, non-income qualified participants no longer have access to bulbs that do not meet the efficacy requirement defined by an EISA backstop provision. That provision effectively ensures that all lamps available in the market are at minimum an LED (no incandescent or compact fluorescent products). Therefore, lamp wattages that were historically considered efficient have now become the baseline to compare against emerging ultra-efficient options. See “Standard-Efficiency LED Baseline Wattage” tables below for specific baseline wattages by lamp type and lumen output.

DEEMED LIFETIME OF EFFICIENT EQUIPMENT

According to the ENERGY STAR Qualified Products list (accessed 6/16/2020), the average rated life for Omnidirectional lamps is approximately 20,000 hours, 17,000 hours for decorative and 25,000 for directional lamps.

DEEMED MEASURE COST

The actual ultra-efficient LED lamp cost should be used. For incremental cost, assume a baseline cost according to the following table¹⁴⁰³:

Bulb Type	Standard LED Baseline Cost
Omnidirectional	\$2.70
Directional	\$5.18
Decorative and Globe	\$3.40

¹⁴⁰³ Baseline and LED lamp costs are based on field data collected by CLEAResult and provided by ComEd. See ComEd Pricing Projections 06302016.xlsx for analysis. Given LED prices are expected to continue declining assumed costs should be reassessed on an annual basis and replaced with IL specific LED program information when available.

LOADSHAPE

Loadshape R06 – Residential Indoor Lighting

Loadshape R07 – Residential Outdoor Lighting

COINCIDENCE FACTOR

For omnidirectional: The summer peak coincidence factor is assumed to be 0.128 for Residential and in-unit Multi Family bulbs,¹⁴⁰⁴ 0.273 for exterior bulbs,¹⁴⁰⁵ and 0.135 for unknown,¹⁴⁰⁶

For specialty bulbs: The summer peak coincidence factor is assumed to be 0.109 for residential and in-unit multifamily bulbs,¹⁴⁰⁷ 0.273 for exterior bulbs¹⁴⁰⁸ and 0.117 for unknown¹⁴⁰⁹.

Use Multifamily if the building meets the utility’s definition for multifamily.

Algorithm

CALCULATION OF ENERGY SAVINGS

ELECTRIC ENERGY SAVINGS

$$\Delta kWh = ((Watts_{base} - Watts_{EE}) / 1000) * ISR * (1 - Leakage) * Hours * WHF_e$$

Where:

Watts_{base} = Input wattage of the existing or baseline system. Reference the “Standard-Efficiency LED Baseline Wattage” table for default values.¹⁴¹⁰

Watts_{EE} = Actual wattage of LED purchased / installed must be used.

Standard-Efficiency LED Baseline Wattage Table: Omnidirectional

Minimum Lumens	Maximum Lumens	Standard LED Baseline Wattage (WattsBase)
120	399	4.0
400	749	6.6
750	899	9.6

¹⁴⁰⁴ Based on the IL Statewide LED Lighting Logger study conducted as part of the PY8/PY9 evaluations of the Ameren Illinois and ComEd Residential Lighting programs.

¹⁴⁰⁵ Based on lighting logger study conducted as part of the PY5/6 ComEd Residential Lighting Program evaluation. the IL Statewide LED Lighting Logger study conducted as part of the PY8/PY9 evaluations of the Ameren Illinois and ComEd Residential Lighting programs was unable to provide coincidence factors for screw-based omnidirectional LEDs in exterior applications.

¹⁴⁰⁶ Based on a weighted average of coincidence factors in interior and exterior applications, assuming 5% exterior lighting. The distribution of LEDs is based on the on-site lighting inventory conducted as part of the IL Statewide LED Lighting Logger study.

¹⁴⁰⁷ Based on the IL Statewide LED Lighting Logger study conducted as part of the PY8/PY9 evaluations of the Ameren Illinois and ComEd Residential Lighting programs.

¹⁴⁰⁸ Based on lighting logger study conducted as part of the PY5/6 ComEd Residential Lighting Program evaluation. the IL Statewide LED Lighting Logger study conducted as part of the PY8/PY9 evaluations of the Ameren Illinois and ComEd Residential Lighting programs was unable to provide coincidence factors for specialty LEDs in exterior applications.

¹⁴⁰⁹ Based on a weighted average of coincidence factors in interior and exterior applications, assuming 5% exterior lighting. The distribution of LEDs is based on the on-site lighting inventory conducted as part of the IL Statewide LED Lighting Logger study.

¹⁴¹⁰ See file “LED Lamp Updates 2021-06-09” for details on Guidehouse lamp wattage calculations based on equivalent baseline wattage and LED wattage of available ENERGY STAR product.

Minimum Lumens	Maximum Lumens	Standard LED Baseline Wattage (WattsBase)
900	1,399	13.1
1,400	1,999	16.0
2,000	2,999	21.8
3,000	3,299	28.9

Standard-Efficiency LED Baseline Wattage Table: Decorative Lamps

Bulb Type	Minimum Lumens	Maximum Lumens	Standard LED Baseline Wattage (WattsBase)
Omni-Directional 3-Way	1,100	1,999	14.7
	2,000	2,700	22.6
Globe (medium and intermediate bases less than 750 lumens)	310	349	3.0
	350	499	4.7
	500	574	5.7
	575	649	6.5
	650	1,000	8.2
Globe (candelabra bases less than 1050 lumens)	310	349	3.5
	350	499	4.4
	500	574	5.5
Decorative (Shapes B, BA, C, CA, DC, F, G, medium and intermediate bases less than 750 lumens)	310	499	4.3
	500	800	5.8
Decorative (Shapes B, BA, C, CA, DC, F, G, candelabra bases less than 1050 lumens)	310	499	4.2
	500	650	5.5
Decorative (Shape ST)	310	499	6.5
	500	999	8.8
	1000	1500	10.0
Decorative (Shape S)	310	340	2.25

Standard-Efficiency LED Baseline Wattage Table: Directional Lamps

Bulb Type	Minimum Lumens	Maximum Lumens	Standard LED Baseline Wattage (Watts _{Base})
Reflector lamp types with medium screw bases (PAR20, PAR30(S,L), PAR38, R40, etc.) w/ diameter >2.25"	400	649	7.0
	650	899	10.7
	900	1,049	13.9
	1,050	1,199	13.8
	1,200	1,499	15.9
	1,500	1,999	18.9
Reflector lamp types with medium screw bases (PAR16, R14, R16, etc.) w/ diameter <2.25"	2,000	3,299	27.3
	310	374	4.6
BR30, BR40, or ER40	375	600	6.4
	650	949	9.3
	950	1,099	12.7
	1,100	1,399	14.4
	1,400	1,600	16.6
R20	1,601	1,800	22.2
	450	524	6.0
	525	750	7.1
MR16	310	324	3.8
	325	369	4.8
	370	400	4.9

Standard-Efficiency LED Baseline Wattage Table: Additional EISA non-exempt bulb types

Bulb Type	Minimum Lumens	Maximum Lumens	Standard LED Baseline Wattage (Watts _{Base})
Dimmable Twist, Globe (less than 5" in diameter and > 749 lumens), candle (shapes B, BA, CA > 749 lumens), Candelabra Base Lamps (>1049 lumens), Intermediate Base Lamps (>749 lumens)	310	399	4.0
	400	749	6.6
	750	899	9.6
	900	1,399	13.1
	1,400	1,999	16.0

ISR = In Service Rate, the percentage of lamps rebated that are actually in service.

Program		In Service Rate (ISR) ^{1411s}
Retail (Time of Sale)		97.9% ¹⁴¹²
Direct Install		94.5% ¹⁴¹³
Virtual Assessment followed by Unverified Self-Install		97.9% ¹⁴¹⁴
Efficiency Kits ¹⁴¹⁵	LED Distribution ¹⁴¹⁶	82.8%
	School Kits ¹⁴¹⁷	83.8%
	Direct Mail Kits ¹⁴¹⁸	91.8%
	Community Distributed Kits ¹⁴¹⁹	95.0%
Food Bank / Pantry Distribution ¹⁴²⁰		97.9% ¹⁴²¹

Leakage = Adjustment to account for the percentage of program bulbs that move out (and in if deemed appropriate)¹⁴²² of the Utility Jurisdiction.

KITS programs = Determined through evaluation

¹⁴¹¹ In Service Rates now represent the lifetime In Service Rates with the second and third year installations discounted by the Real Discount Rate of 0.46%. Lifetime ISR assumptions for efficiency kits are based upon comparing with CFL Distribution First year ISR and multiplying by the CFL Distribution Final ISR value, capped at 95%, and second and third year estimates based on same proportion of future installs. For all other programs the 98% Lifetime ISR assumption is based upon the standard CFL measure in the absence of any better reference. This value is based upon review of two evaluations: ‘Nexus Market Research, RLW Analytics and GDS Associates study; ‘New England Residential Lighting Markdown Impact Evaluation, January 20, 2009’ and ‘KEMA Inc, Feb 2010, Final Evaluation Report; Upstream Lighting Program, Volume 1.’ This implies that only 2% of bulbs purchased are never installed. The second and third year installations are based upon Ameren analysis of the Californian KEMA study showing that 54% of future installs occur in year 2 and 46% in year 3.

¹⁴¹² 1st year in service rate is based upon analysis of ComEd PY8, PY9 and CY2018 and Ameren PY8 intercept data (see ‘RES Lighting ISR_2019.xlsx’ for more information).

¹⁴¹³ Based upon average of Navigant low income single family direct install field work LED ISR and Standard CFL assumption in the absence of better data, and is based upon review of the PY2 and PY3 ComEd Direct Install program surveys. This value includes bulb failures in the 1st year to be consistent with the Commission approval of annualization of savings for first year savings claims. ComEd PY2 All Electric Single Family Home Energy Performance Tune-Up Program Evaluation, Navigant Consulting, December 21, 2010.

¹⁴¹⁴ An equal weighted average of Direct Install and Direct Mail Kit ISRs. Interest and applicability of measures confirmed through virtual assessment.

¹⁴¹⁵ In Service Rates provided are for the bulb within a kit only. Given the significant differences in program design and the level of education provided through Efficiency Kits programs, the evaluators should apply the ISR estimated through evaluations (either past evaluations or the current program year evaluation) of the specific Efficiency Kits program. In cases where program-specific evaluation results for an ISR are unavailable, the default ISR values for Efficiency Kits provide may be used.

¹⁴¹⁶ Free bulbs provided without request, with little or no education. Consistent with Standard CFL assumptions.

¹⁴¹⁷ 1st year ISR for school kits based on ComEd PY9 data for the Elementary Energy Education program. Final ISR assumptions are based upon comparing with CFL Distribution First year ISR and multiplying by the CFL Distribution Final ISR value, and second and third year estimates based on same proportion of future installs.

¹⁴¹⁸ Opt-in program to receive kits via mail, with little or no education. Consistent with Standard CFL assumptions.

¹⁴¹⁹ Kits distributed in a community setting, targeted to income qualified communities. Research from 2018 Ameren Illinois Income Qualified participant survey.

¹⁴²⁰ Free bulbs provided through local food banks and food pantries.

¹⁴²¹ 1st year ISR is determined based on online surveys conducted for ComEd CY2018 Food Bank LED Distribution program. See ‘CY2018 ComEd Foodbank LED Dist Survey Results_Navigant’.

¹⁴²² Leakage in is only appropriate to credit to IL utility program savings if it is reasonably expected that the IL utility program marketing efforts played an important role in influencing customer to purchase the light bulbs. Furthermore, consideration that such customers might be free riders should be addressed. If leakage in is assessed, efforts should be made to ensure no double counting of savings occurs if the evaluation is estimating both leakage in and spillover savings of light bulbs.

Upstream (TOS) Lighting programs = Use deemed assumptions below:¹⁴²³

ComEd: 0.95%
Ameren: 13.1%

All other programs = 0

Hours = Average hours of use per year depending on bulb type

Installation Location	Omnidirectional Hours	Specialty Hours
Residential and in-unit Multi Family	1,089 ¹⁴²⁴	763 ¹⁴²⁵
Exterior	2,475 ¹⁴²⁶	2,475 ¹⁴²⁷
Unknown	1,159 ¹⁴²⁸	1,020 ¹⁴²⁹

WHFe = Waste heat factor for energy to account for cooling energy savings from efficient lighting

Bulb Location	WHFe
Interior single family	1.06 ¹⁴³⁰
Multifamily in unit	1.04 ¹⁴³¹
Exterior or uncooled location	1.0
Unknown location	1.049 ¹⁴³²

HEATING PENALTY

If electric heated home (if heating fuel is unknown assume gas, see Fossil Fuel section):

¹⁴²³ Leakage rate is based upon an average of the decorative and omnidirectional leakage values provided from a review of evaluations from ComEd and Ameren.

¹⁴²⁴ Based on the IL Statewide LED Lighting Logger study conducted as part of the PY8/PY9 evaluations of the Ameren Illinois and ComEd Residential Lighting programs.

¹⁴²⁵ Based on the IL Statewide LED Lighting Logger study conducted as part of the PY8/PY9 evaluations of the Ameren Illinois and ComEd Residential Lighting programs.

¹⁴²⁶ Based on lighting logger study conducted as part of the PY5/6 ComEd Residential Lighting Program evaluation. The IL Statewide LED Lighting Logger study conducted as part of the PY8/PY9 evaluations of the Ameren Illinois and ComEd Residential Lighting programs was unable to provide hours of use for screw-based omnidirectional LEDs in exterior applications.

¹⁴²⁷ Based on lighting logger study conducted as part of the PY5/6 ComEd Residential Lighting Program evaluation. The IL Statewide LED Lighting Logger study conducted as part of the PY8/PY9 evaluations of the Ameren Illinois and ComEd Residential Lighting programs was unable to provide hours of use for specialty LEDs in exterior applications.

¹⁴²⁸ Based on a weighted average of hours of use in interior and exterior applications, assuming 5% exterior lighting. The distribution of LEDs is based on the on-site lighting inventory conducted as part of the IL Statewide LED Lighting Logger study.

¹⁴²⁹ Based on a weighted average of interior and exterior hours of use from the IL Statewide LED Lighting Logger study conducted as part of the PY8/PY9 evaluations of the Ameren Illinois and ComEd Residential Lighting programs, assuming 15% exterior specialty lighting. The distribution of LEDs is based on the on-site lighting inventory conducted as part of the IL Statewide LED Lighting Logger study.

¹⁴³⁰ The value is estimated at 1.06 (calculated as $1 + (0.66 * (0.27 / 2.8))$). Based on cooling loads decreasing by 27% of the lighting savings (average result from REMRate modeling of several different configurations and IL locations of homes), assuming typical cooling system operating efficiency of 2.8 COP (starting from standard assumption of SEER 10.5 central AC unit, converted to 9.5 EER using algorithm $(-0.02 * SEER2) + (1.12 * SEER)$ (from Wassmer, M. (2003). A Component-Based Model for Residential Air Conditioner and Heat Pump Energy Calculations. Masters Thesis, University of Colorado at Boulder), converted to $COP = EER/3.412 = 2.8COP$) and 66% of homes in Illinois having central cooling ("Table HC7.9 Air Conditioning in Homes in Midwest Region, Divisions, and States, 2009 from Energy Information Administration", 2009 Residential Energy Consumption Survey)

¹⁴³¹ As above but using estimate of 45% of multifamily buildings in Illinois having central cooling (based on data from "Table HC7.1 Air Conditioning in U.S. Homes, By Housing Unit Type, 2009" which is for the whole of the US, scaled to IL air conditioning prevalence compared to US average)

¹⁴³² Unknown is the average of the 5.5.6 LED Specialty Lamps and 5.5.8 LED Screw Based Omnidirectional Bulbs unknown assumptions.

$$\Delta kWh^{1433} = - (((WattsBase - WattsEE) / 1000) * ISR * (1 - Leakage) * Hours * HF) / \eta_{Heat}$$

Where:

- HF = Heating Factor or percentage of light savings that must be heated
 = 49% for interior¹⁴³⁴
 = 0% for exterior or unheated location
 = 42% for unknown location¹⁴³⁵
- η_{Heat} = Efficiency in COP of Heating equipment
 = actual. If not available use:¹⁴³⁶

System Type	Age of Equipment	HSPF2 Estimate	COP _{HEAT} (COP Estimate) = (HSPF2/3.413)*0.85
Heat Pump (if age unknown assume 2006-2014)	Before 2006	5.8	1.44
	After 2006 - 2014	6.5	1.62
	2015 on	7.0	1.74
Resistance	N/A	N/A	1.00
Unknown ¹⁴³⁷	N/A	N/A	1.28

SUMMER COINCIDENT PEAK DEMAND SAVINGS

$$\Delta kW = ((WattsBase - WattsEE) / 1000) * ISR * (1 - Leakage) * WHFd * CF$$

Where:

- WHFd = Waste heat factor for demand to account for cooling savings from efficient lighting.

Bulb Location	WHFd
Interior single family	1.11 ¹⁴³⁸
Multifamily in unit	1.07 ¹⁴³⁹

¹⁴³³ Negative value because this is an increase in heating consumption due to the efficient lighting.

¹⁴³⁴ This means that heating loads increase by 49% of the lighting savings. This is based on the average result from REMRate modeling of several different configurations and IL locations of homes.

¹⁴³⁵ Based on a weighted average of interior and exterior hours of use from the IL Statewide LED Lighting Logger study conducted as part of the PY8/PY9 evaluations of the Ameren Illinois and ComEd Residential Lighting programs, assuming 15% exterior specialty lighting. The distribution of LEDs is based on the on-site lighting inventory conducted as part of the IL Statewide LED Lighting Logger study.

¹⁴³⁶ These default system efficiencies are based on the applicable minimum Federal Standards. In 2006 the Federal Standard for Heat Pumps was adjusted. While one would expect the average system efficiency to be higher than this minimum, the likely degradation of efficiencies over time mean that using the minimum standard is appropriate. Note efficiency should include duct losses. Defaults provided assume 15% duct loss for heat pumps.

¹⁴³⁷ Calculation assumes 35% Heat Pump and 65% Resistance, which is based upon data from Energy Information Administration, 2009 Residential Energy Consumption Survey, see "HC6.9 Space Heating in Midwest Region.xls", using average for East North Central Region. Average efficiency of heat pump is based on assumption that 50% are units from before 2006 and 50% from 2006-2014. Program or evaluation data should be used to improve this assumption if available.

¹⁴³⁸ The value is estimated at 1.11 (calculated as 1 + (0.66 * 0.466 / 2.8)). See footnote relating to WHFe for details. Note the 46.6% factor represents the average Residential cooling coincidence factor calculated by dividing average load during the peak hours divided by the maximum cooling load.

¹⁴³⁹ As above but using estimate of 45% of multifamily buildings in Illinois having central cooling (based on data from "Table

Bulb Location	WHFd
Exterior or uncooled location	1.0
Unknown location	1.088 ¹⁴⁴⁰

CF = Summer Peak Coincidence Factor for measure. See table depending on the bulb type

Bulb Location	Omnidirectional CF	Specialty CF
Interior	0.128 ¹⁴⁴¹	0.109 ¹⁴⁴²
Exterior	0.273 ¹⁴⁴³	0.273 ¹⁴⁴⁴
Unknown	0.135 ¹⁴⁴⁵	0.177 ¹⁴⁴⁶

Other factors as defined above

FOSSIL FUEL SAVINGS

Heating penalty if Natural Gas heated home, or if heating fuel is unknown.

$$\Delta\text{Therms} = - ((\text{WattsBase} - \text{WattsEE}) / 1000) * \text{ISR} * (1 - \text{Leakage}) * \text{Hours} * \text{HF} * 0.03412 / \eta\text{Heat}$$

Where:

- HF = Heating factor, or percentage of lighting savings that must be replaced by heating system.
 - = 49% for interior¹⁴⁴⁷
 - = 0% for exterior location
 - = 42% for unknown location¹⁴⁴⁸
- 0.03412 = Converts kWh to Therms
- ηHeat = Average heating system efficiency.

HC7.1 Air Conditioning in U.S. Homes, By Housing Unit Type, 2009” which is for the whole of the US, scaled to IL air conditioning prevalence compared to US average)

¹⁴⁴⁰ Unknown is the average of the 5.5.6 LED Specialty Lamps and 5.5.8 LED Screw Based Omnidirectional Bulbs unknown assumptions.

¹⁴⁴¹ Based on the IL Statewide LED Lighting Logger study conducted as part of the PY8/PY9 evaluations of the Ameren Illinois and ComEd Residential Lighting programs.

¹⁴⁴² Based on the IL Statewide LED Lighting Logger study conducted as part of the PY8/PY9 evaluations of the Ameren Illinois and ComEd Residential Lighting programs.

¹⁴⁴³ Based on lighting logger study conducted as part of the PY5/6 ComEd Residential Lighting Program evaluation. the IL Statewide LED Lighting Logger study conducted as part of the PY8/PY9 evaluations of the Ameren Illinois and ComEd Residential Lighting programs was unable to provide coincidence factors for screw-based omnidirectional LEDs in exterior applications.

¹⁴⁴⁴ Based on lighting logger study conducted as part of the PY5/6 ComEd Residential Lighting Program evaluation. the IL Statewide LED Lighting Logger study conducted as part of the PY8/PY9 evaluations of the Ameren Illinois and ComEd Residential Lighting programs was unable to provide coincidence factors for specialty LEDs in exterior applications.

¹⁴⁴⁵ Based on a weighted average of coincidence factors in interior and exterior applications, assuming 5% exterior lighting. The distribution of LEDs is based on the on-site lighting inventory conducted as part of the IL Statewide LED Lighting Logger study.

¹⁴⁴⁶ Based on a weighted average of coincidence factors in interior and exterior applications, assuming 5% exterior lighting. The distribution of LEDs is based on the on-site lighting inventory conducted as part of the IL Statewide LED Lighting Logger study.

¹⁴⁴⁷ Average result from REMRate modeling of several different configurations and IL locations of homes

¹⁴⁴⁸ Based on a weighted average of interior and exterior hours of use from the IL Statewide LED Lighting Logger study conducted as part of the PY8/PY9 evaluations of the Ameren Illinois and ComEd Residential Lighting programs, assuming 15% exterior specialty lighting. The distribution of LEDs is based on the on-site lighting inventory conducted as part of the IL Statewide LED Lighting Logger study.

$$= 0.70^{1449}$$

WATER AND OTHER NON-ENERGY IMPACT DESCRIPTIONS AND CALCULATION

N/A

DEEMED O&M COST ADJUSTMENT CALCULATION

N/A

MEASURE CODE: RS-LTG-ULED-V1-240101

REVIEW DEADLINE: 1/1/2026

¹⁴⁴⁹ This has been estimated assuming that natural gas central furnace heating is typical for Illinois residences (66% of Illinois homes have a Natural Gas Furnace (based on Energy Information Administration, 2009 Residential Energy Consumption Survey) In 2000, 24% of furnaces purchased in Illinois were condensing (based on data from GAMA, provided to Department of Energy during the federal standard setting process for residential heating equipment - see Furnace Penetration.xls). Furnaces tend to last up to 20 years and so units purchased 10 years ago provide a reasonable proxy for the current mix of furnaces in the State. Assuming typical efficiencies for condensing and non-condensing furnaces and duct losses, the average heating system efficiency is estimated as follows:

$$(0.24*0.92) + (0.76*0.8) * (1-0.15) = 0.70$$

5.6 Shell End Use

5.6.1 Air Sealing

DESCRIPTION

Thermal shell air leaks are sealed through strategic use and location of air-tight materials. Leaks are detected and leakage rates measured with the assistance of a blower-door. The algorithm for this measure can be used when the program implementation does not allow for more detailed forecasting through the use of residential modeling software. Prescriptive savings are provided for use only when a blower door test is not conducted.

This measure was developed to be applicable to the following program types: RF.

If applied to other program types, the measure savings should be verified.

DEFINITION OF EFFICIENT EQUIPMENT

Air sealing materials and diagnostic testing should meet all eligibility program qualification criteria. The initial and final tested leakage rates should be performed in such a manner that the identified reductions can be properly discerned, particularly in situations wherein multiple building envelope measures may be implemented simultaneously.

DEFINITION OF BASELINE EQUIPMENT

The existing air leakage should be determined through approved and appropriate test methods using a blower door. The baseline condition of a building upon first inspection significantly impacts the opportunity for cost-effective energy savings through air-sealing. Savings are provided for prescriptive air sealing measures when a blower door test is not conducted.

DEEMED LIFETIME OF EFFICIENT EQUIPMENT

The expected measure life is assumed to be 20 years.¹⁴⁵⁰

The expected measure life of prescriptive shrink-fit window film is assumed to be 1 year.

Note a mid-life adjustment to account for replacement of HVAC equipment during the measure life should be applied after 10 years or 13 years for boilers.¹⁴⁵¹ See section below for detail.

DEEMED MEASURE COST

The actual capital cost for this measure should be used in screening.

LOADSHAPE

Loadshape R08 - Residential Cooling

Loadshape R09 - Residential Electric Space Heat

Loadshape R10 - Residential Electric Heating and Cooling

COINCIDENCE FACTOR

The summer peak coincidence factor for cooling is provided in two different ways below. The first is used to estimate peak savings during the utility peak hour and is most indicative of actual peak benefits, and the second represents the *average* savings over the defined summer peak period, and is presented so that savings can be bid into PJM's capacity market.

¹⁴⁵⁰ As recommended in Navigant 'ComEd Effective Useful Life Research Report', May 2018.

¹⁴⁵¹ This is intentionally longer than the assumptions found in the early replacement measures as the application of this measure will occur in a variety of homes that will not be targeted for early replacement HVAC systems.

CF _{SSP}	= Summer System Peak Coincidence Factor for Central A/C (during utility peak hour) = 68% ¹⁴⁵²
CF _{SSP SF}	= Summer System Peak Coincidence Factor for Heat Pumps in single-family homes (during system peak hour) = 72% ¹⁴⁵³
CF _{SSP, MF}	= Summer System Peak Coincidence Factor for Heat Pumps in multi-family homes (during system peak hour) = 67% ¹⁴⁵⁴
CF _{PJM}	= PJM Summer Peak Coincidence Factor for Central A/C (average during PJM peak period) = 46.6% ¹⁴⁵⁵
CF _{PJM SF}	= PJM Summer Peak Coincidence Factor for Heat Pumps in single-family homes (average during PJM peak period) = 46.6% ¹⁴⁵⁶
CF _{PJM, MF}	= PJM Summer Peak Coincidence Factor for Heat Pumps in multi-family homes (average during peak period) = 28.5%

Algorithm

CALCULATION OF SAVINGS

ELECTRIC ENERGY SAVINGS

Methodology 1: Blower Door Test

Required methodology when blower door testing is conducted.

$$\Delta kWh = \Delta kWh_{cooling} + \Delta kWh_{heatingElectric} + \Delta kWh_{heatingFurnace}$$

Where:

$$\Delta kWh_{cooling} = \text{If central cooling, reduction in annual cooling requirement due to air sealing}$$

$$= \left[\frac{((CFM50_{existing} - CFM50_{new}) / N_{cool}) * 60 * 24 * CDD * DUA * 0.018}{(1,000 * \eta_{Cool}) * LM * ADJ_{AirSealingCool}} \right] * IE_{NetCorrection} * \%Cool$$

$$CFM50_{existing} = \text{Infiltration at 50 Pascals as measured by blower door before air sealing.}$$

$$= \text{Actual}$$

¹⁴⁵² Based on metering of 24 homes with central AC during PY4 and PY5 in Ameren Illinois service territory.

¹⁴⁵³ Based on analysis of metering results from 24 heat pumps in Ameren Illinois service territory in PY5 coincident with AIC's 2010 system peak; 'Impact and Process Evaluation of Ameren Illinois Company's Residential HVAC Program (PY5)'.

¹⁴⁵⁴ Multifamily coincidence factors both from; *All-Electric Homes PY6 Metering Results: Multifamily HVAC Systems*, Cadmus, October 2015

¹⁴⁵⁵ Based on analysis of Itron eShape data for Missouri, calibrated to Illinois loads, supplied by Ameren. The average AC load over the PJM peak period (1-5pm, M-F, June through August) is divided by the maximum AC load during the year.

¹⁴⁵⁶ Based on analysis of Itron eShape data for Missouri, calibrated to Illinois loads, supplied by Ameren. The average AC load over the PJM peak period (1-5pm, M-F, June through August) is divided by the maximum AC load during the year.

CFM50_new = Infiltration at 50 Pascals as measured by blower door after air sealing.
 = Actual

N_cool = Conversion factor from leakage at 50 Pascal to leakage at natural conditions
 =Dependent on location and number of stories:¹⁴⁵⁷

Climate Zone (City based upon) ¹⁴⁵⁸	N_cool (by # of stories)			
	1	1.5	2	3
1 (Rockford)	39.5	35.0	32.1	28.4
2 (Chicago)	38.9	34.4	31.6	28.0
3 (Springfield)	41.2	36.5	33.4	29.6
4 (St Louis, MO)	40.4	35.8	32.9	29.1
5 (Paducah, KY)	43.6	38.6	35.4	31.3

60 * 24 = Converts Cubic Feet per Minute to Cubic Feet per Day

CDD = Cooling Degree Days
 = Dependent on location:¹⁴⁵⁹

Climate Zone (City based upon)	CDD 65
1 (Rockford)	877
2 (Chicago)	1047
3 (Springfield)	1183
4 (Belleville)	1641
5 (Marion/Murphysboro)	1450

DUA = Discretionary Use Adjustment (reflects the fact that people do not always operate their AC when conditions may call for it).
 = 0.75 ¹⁴⁶⁰

0.018 = Specific Heat Capacity of Air (Btu/ft³*°F)

1000 = Converts Btu to kBtu

ηCool = Efficiency (SEER2) of Air Conditioning equipment (kBtu/kWh)
 = Actual (where it is possible to measure or reasonably estimate). Note where new HVAC is installed in addition to shell measures, the old HVAC unit efficiency should be used and

¹⁴⁵⁷ N-factor is used to convert 50-pascal blower door air flows to natural air flows and is dependent on geographic location and # of stories. These were developed by applying the LBNL infiltration model (see LBNL paper 21040, *Exegisis of Proposed ASHRAE Standard 119: Air Leakage Performance for Detached Single-Family Residential Buildings*; Sherman, 1986; page v-vi, Appendix page 7-9) to the reported wind speeds and outdoor temperatures provided by the NRDC 30 year climate normals. For more information see Bruce Harley, CLEARResult “Infiltration Factor Calculations Methodology.doc”.

¹⁴⁵⁸ Note, the methodology for developing n-factors requires hourly normals as opposed to annual normals which are used for other assumptions in the TRM. Hourly normals were not available for all sites used for other climate assumptions and so the nearest locations were used (St Louis, MO for Belleville, IL and Paducah, KY for Marion, IL).

¹⁴⁵⁹ National Centers for Environmental Information (NCEI) Annual Normals, from 2006 - 2020, calculated with a base temp of 65°F.

¹⁴⁶⁰ This factor's source is: Energy Center of Wisconsin, May 2008 metering study; “Central Air Conditioning in Wisconsin, A Compilation of Recent Field Research”, p31.

the shell measure savings calculated first, the HVAC measure then assuming the reduced heat/cooling loads. If using rated efficiencies, derate efficiency value by 1% per year (maximum of 30 years) to account for degradation over time,¹⁴⁶¹ or if unknown assume the following.¹⁴⁶² If unknown value is used, it should not be derated by age.

Age of Equipment	SEER2 Estimate
Before 2006	9.5
2006 - 2014	12.4
Central AC After 1/1/2015	12.4
Heat Pump After 1/1/2015	13.3
Unknown (for use in program evaluation only)	10.0

LM = Latent multiplier to account for latent cooling demand¹⁴⁶³

Climate Zone (City based upon)	LM
1 (Rockford)	3.3
2 (Chicago)	3.2
3 (Springfield)	3.7
4 (St Louis, MO)	3.6
5 (Paducah, KY)	3.7

ADJ_{AirSealingCool} = Adjustment for cooling savings to account for inaccuracies in engineering algorithms¹⁴⁶⁴

Measure	ADJ _{AirSealingCool}
Air sealing and attic insulation	114%
Air sealing without attic insulation	100%

IE_{NetCorrection} = 100% if not income eligible or air sealing is installed without attic insulation.

= 110% if installing air sealing and attic insulation in income eligible projects with a deemed NTG value of 1.0 to offset net savings adjustment inherent when using

¹⁴⁶¹ Justification for degradation factors can be found on page 14 of ‘A/C HVAC Metering Study Memo FINAL 2_28_2018’. Estimate efficiency as (Rated Efficiency * (1-0.01)^{Equipment Age}).

¹⁴⁶² These default system efficiencies are based on the applicable minimum Federal Standards. In 2006 the Federal Standard for Central AC was adjusted. While one would expect the average system efficiency to be higher than this minimum, the likely degradation of efficiencies over time mean that using the minimum standard is appropriate. Note all ratings have been converted to SEER2 equivalents – since the new rating better reflects the actual efficiency of the units.

¹⁴⁶³ Derived by calculating the sensible and total loads in each hour. For more information see Bruce Harley, CLEAResult “Infiltration Factor Calculations Methodology.doc”. Note, the methodology requires hourly normals as opposed to annual normals which are used for other assumptions in the TRM. Hourly normals were not available for all sites used for other climate assumptions and so the nearest locations were used (St Louis, MO for Belleville, IL and Paducah, KY for Marion, IL).

¹⁴⁶⁴ As demonstrated in air sealing and insulation research by Navigant, see Navigant (2018). *ComEd and Nicor Gas Air Sealing and Insulation Research Report*. Presented to Commonwealth Edison Company and Nicor Gas Company.

These adjustment factors are based on a consumption data analysis using matching to non-participants. The values are therefore between net and gross with respect to free ridership. Like all consumption data analyses, they are net with respect to participant spillover and gross with respect to non-participant spillover. For more detail, see Table 5-3 in Volume 4 of the IL-TRM. Consistent with Section 7.2 of the Illinois EE Policy Manual, applicable net-to-gross adjustments to the savings will be determined as part of the annual SAG net-to-gross process. During update cycle for version v.12, applied the percent change of NCEI Annual Normals CDD65 from 30 yr data set (1981-2010) to more recent 15 yr data (2006-2020) for all cooling-related adjustment values.

$ADJ_{AirSealingCool}$ of 114%¹⁴⁶⁵

%Cool = Percent of homes that have cooling

Central Cooling?	%Cool
Yes	100%
No	0%
Unknown (for use in program evaluation only) ¹⁴⁶⁶	66%

$\Delta kWh_{heatingElectric}$ sealing = If electric heat (resistance or heat pump), reduction in annual electric heating due to air sealing

$$= \left[\frac{((CFM50_{existing} - CFM50_{new}) / N_{heat}) * 60 * 24 * HDD * 0.018}{(\eta_{Heat} * 3,412)} \right] * \%ElectricHeat$$

N_{heat} = Conversion factor from leakage at 50 Pascal to leakage at natural conditions
 = Based on climate zone, building height and exposure level:¹⁴⁶⁷

Climate Zone (City based upon)	N_heat (by # of stories)			
	1	1.5	2	3
1 (Rockford)	23.8	21.1	19.3	17.1
2 (Chicago)	23.9	21.1	19.4	17.2
3 (Springfield)	24.2	21.5	19.7	17.4
4 (St Louis, MO)	25.4	22.5	20.7	18.3
5 (Paducah, KY)	27.8	24.6	22.6	20.0

HDD = Heating Degree Days
 = Dependent on location:¹⁴⁶⁸

Climate Zone (City based upon)	HDD 60
1 (Rockford)	5230
2 (Chicago)	4798
3 (Springfield)	4266
4 (Belleville)	3188

¹⁴⁶⁵ The additional value of 10% was selected to acknowledge that some portion of the regression-derived adjustment factors accounts for gross impact effects, and that removing net effects embedded in the adjustment factors would increase savings to some degree. A review of historical NTG values for air sealing and insulation measures in non-income eligible populations did not provide definitive guidance for estimating the net component of the adjustment factors. Historically, free ridership has ranged from 9% to 26% for like measures, and spillover has ranged from 1% to 14%, while NTGs have ranged from 0.75 to 1.05. The midpoint of the NTG range would be 0.90, a 10% reduction from 1.0.

¹⁴⁶⁶ Percentage of homes in Illinois that have central cooling from “Table HC7.9 Air Conditioning in Homes in Midwest Region, Divisions, and States, 2009” from Energy Information Administration, 2009 Residential Energy Consumption Survey

¹⁴⁶⁷ N-factor is used to convert 50-pascal blower door air flows to natural air flows and is dependent on geographic location and # of stories. These were developed by applying the LBNL infiltration model (see LBNL paper 21040, *Exegisis of Proposed ASHRAE Standard 119: Air Leakage Performance for Detached Single-Family Residential Buildings*; Sherman, 1986; page v-vi, Appendix page 7-9) to the reported wind speeds and outdoor temperatures provided by the NRDC 30 year climate normals. For more information see Bruce Harley, CLEAResult “Infiltration Factor Calculations Methodology.doc”. Note, the methodology for developing n-factors requires hourly normals as opposed to annual normals which are used for other assumptions in the TRM. Hourly normals were not available for all sites used for other climate assumptions and so the nearest locations were used (St Louis, MO for Belleville, IL and Paducah, KY for Marion, IL).

¹⁴⁶⁸ National Climatic Data Center, calculated from 1981-2010 climate normals with a base temp of 60°F.

Climate Zone (City based upon)	HDD 60
5 (Marion/Murphysboro)	3390

η_{Heat} = Efficiency of heating system

= Actual heat efficiency * distribution efficiency (where it is possible to measure or reasonably estimate). Note where new HVAC is installed in addition to shell measures, the old HVAC unit efficiency should be used and the shell measure savings calculated first, the HVAC measure then assuming the reduced heat/cooling loads. If using rated efficiencies, derate efficiency value by 1% per year (maximum of 30 years) to account for degradation over time,¹⁴⁶⁹ or if not available refer to default table below.¹⁴⁷⁰ If unknown value is used, it should not be derated by age. If actual Distribution Efficiency is not available, use 85% for heat pumps.

System Type	Age of Equipment	HSPF2 Estimate	η_{Heat} (Effective COP Estimate * Distribution Efficiency) = $(HSPF2/3.413)*0.85$
Heat Pump (if age unknown assume 2006-2014)	Before 2006	5.8	1.44
	2006 - 2014	6.5	1.62
	2015 on	7.0	1.74
Resistance	N/A	N/A	1.00
Unknown (for use in program evaluation only) ¹⁴⁷¹	N/A	N/A	1.32

3412 = Converts Btu to kWh

%ElectricHeat = Percent of homes that have electric space heating

= 100 % for Electric Resistance or Heat Pump

= 0 % for Fossil Fuels

= If unknown¹⁴⁷², use the following table:

¹⁴⁶⁹ Justification for degradation factors can be found on page 14 of 'AIC HVAC Metering Study Memo FINAL 2_28_2018'. Estimate efficiency as (Rated Efficiency * (1-0.01)^Equipment Age).

¹⁴⁷⁰ These default system efficiencies are based on the applicable minimum Federal Standards. In 2006 the Federal Standard for Heat Pumps was adjusted. While one would expect the average system efficiency to be higher than this minimum, the likely degradation of efficiencies over time means that using the minimum standard is appropriate. An 85% distribution efficiency is then applied to account for duct losses for heat pumps. Note all ratings have been converted to HSPF2 equivalents – since the new rating better reflects the actual efficiency of the units.

¹⁴⁷¹ Calculation assumes 35% Heat Pump and 65% Resistance, which is based upon data from Energy Information Administration, 2009 Residential Energy Consumption Survey, see "HC6.9 Space Heating in Midwest Region.xls", using average for East North Central Region. Average efficiency of heat pump is based on assumption that 50% are units from before 2006 and 50% from 2006-2014. Program or evaluation data should be used to improve this assumption if available.

¹⁴⁷² Based on the average % Natural Gas used for space heating in Unknown residential structure types across all utilities covered by the IL program. Residence types include: SF, SF LI, MF & MF LI. Utilities included: Ameren, ComEd, People's Gas, Northshore Gas & Nicor. Data provided from 2016 Ameren Illinois Demand Side Management (DSM) Market Potential Study by Applied Energy Group, ComEd's 2019 Baseline Survey on residential space heating share, and PY2022-2023 Implementation Contractors Data for People's Gas, Northshore Gas & Nicor .

Utility	Location				
	Single Family	Single Family Low Income	Multi Family	Multi Family Low Income	Unknown
Ameren	18%	26%	38%	39%	29%
ComEd	14%	22%	43%	48%	21%
PGL	1.0%	1.5%	4.0%	2.8%	2.2%
NSG	1.3%	0.8%	32.5%	1.2%	3.3%
Nicor	1.3%	0.8%	32.5%	1.2%	3.3%
All DUs ¹⁴⁷³					26%

Note: If a measure is supported by a gas and electric utility through a joint program, and it is unknown whether the participant has a gas supply, the electric utility values in the table above should be used. If it is known that the participant has a gas supply, the values from the gas utility above should be applied.

For example: energy savings from air sealing. Energy savings for attic insulation are included in a separate example in Section 5.6.5: Ceiling/Attic Insulation.

Assume a 2-story single family non-income eligible home in Chicago completes air sealing, installs attic insulation, has 10.5 SEER central cooling and a heat pump with COP of 2 (1.92 including distribution losses), and has pre and post blower door test results of 3,400 and 2,250 CFM:

$$\begin{aligned}
 \Delta kWh &= \Delta kWh_{cooling} + \Delta kWh_{heating} \\
 &= [(((3,400 - 2,250) / 31.6) * 60 * 24 * 1,047 * 0.75 * 0.018) / (1,000 * 10.5) * 3.2 * 114\%] * 100\% * 100\% + [(((3,400 - 2,250) / 19.4) * 60 * 24 * 4,798 * 0.018) / (1.92 * 3,412)] * 100\% \\
 &= 257 + 1,125 \\
 &= 1,382 kWh
 \end{aligned}$$

$\Delta kWh_{heatingFurnace}$ = If fossil fuel *furnace* heat, kWh savings for reduction in fan run time

$$= \Delta Therms * F_e * 29.3 * ADJ_{AirSealingHeatFan}$$

F_e = Furnace Fan energy consumption as a percentage of annual fuel consumption
= 3.14%¹⁴⁷⁴

29.3 = kWh per therm

$ADJ_{AirSealingHeatFan}$ = Adjustment for fan savings during heating season to account for inaccuracies in engineering algorithms¹⁴⁷⁵

¹⁴⁷³ For the weighted average calculations, please see the Analysis file. PGL, NSG, Nicor & gas customers were assumed to follow the provided split. ComEd total customers, minus overlap with PGL, NSG & Nicor, therefore electric only homes. Ameren is total customers minus Nicor.

¹⁴⁷⁴ F_e is not one of the AHRI certified ratings provided for residential furnaces, but can be reasonably estimated from a calculation based on the certified values for fuel energy (E_f in MMBtu/yr) and E_{ae} (kWh/yr). An average of a 300 record sample (non-random) out of 1495 was 3.14%. This is, appropriately, ~50% greater than the ENERGY STAR version 3 criteria for 2% F_e . See "Programmable Thermostats Furnace Fan Analysis.xlsx" for reference.

¹⁴⁷⁵ As demonstrated in air sealing and insulation research by Navigant, see Navigant (2018). *ComEd and Nicor Gas Air Sealing and Insulation Research Report*. Presented to Commonwealth Edison Company and Nicor Gas Company. These adjustment factors are based on a consumption data analysis using matching to non-participants. The values are therefore between net and gross with respect to free ridership. Like all consumption data analyses, they are net with respect to participant spillover and gross with respect to non-participant spillover. For more detail, see Table 5-3 in Volume 4 of the IL-TRM. Consistent with Section 7.2 of the

Measure	ADJ _{AirSealingHeatFan}
Air sealing and attic insulation	113%
Air sealing without attic insulation	100%

For example: energy savings from air sealing. Energy savings for attic insulation are included in a separate example in Section 5.6.5: Ceiling/Attic Insulation.

Assume a well shielded, 2-story non-income eligible single family home in Chicago completes air sealing, installs attic insulation, has a gas furnace with system efficiency of 70%, and has pre and post blower door test results of 3,400 and 2,250 CFM (see therm calculation in Fossil Fuel Savings section):

$$\begin{aligned} \Delta kWh_{\text{heatingGas}} &= 77.8 * 0.0314 * 29.3 * 113\% \\ &= 80.8 \text{ kWh} \end{aligned}$$

Methodology 2: Prescriptive Infiltration Reduction Measures¹⁴⁷⁶

Savings shall only be calculated via Methodology 2 if a blower door test is not conducted.

$$\begin{aligned} \Delta kWh &= (\Delta kWh_{\text{Heating}} + \Delta kWh_{\text{Cooling}}) * ADJ_{\text{RxAirsealing}} \\ \Delta kWh_{\text{Heating}} &= (\Delta kWh_{\text{gasket_heat}} * n_{\text{gasket}} * ISR + \Delta kWh_{\text{windows_heat}} * sf_{\text{windows}} * ISR + \Delta kWh_{\text{sweep_heat}} * n_{\text{sweep}} * ISR + \Delta kWh_{\text{sealing_heat}} * If_{\text{sealing}} * ISR + \Delta kWh_{\text{WX_heat}} * If_{\text{WX}} * ISR) \\ \Delta kWh_{\text{Cooling}} &= (\Delta kWh_{\text{gasket_cool}} * n_{\text{gasket}} * ISR + \Delta kWh_{\text{windows_cool}} * sf_{\text{windows}} * ISR + \Delta kWh_{\text{sweep_cool}} * n_{\text{sweep}} * ISR + \Delta kWh_{\text{sealing_cool}} * If_{\text{sealing}} * ISR + \Delta kWh_{\text{WX_cool}} * If_{\text{WX}} * ISR) \end{aligned}$$

Where:

$\Delta kWh_{\text{gasket}}$ = Annual kWh savings from installation of air sealing gasket on an electric outlet on an external wall.

Climate Zone (City based upon)	$\Delta kWh_{\text{gasket_heat}} / \text{gasket}$		$\Delta kWh_{\text{gasket_cool}} / \text{gasket}$	
	Electric Resistance	Heat Pump	With Cooling	Unknown Cooling
1 (Rockford)	10.5	5.3	1	0.7
2 (Chicago)	10.2	5.1	1.2	0.8
3 (Springfield)	8.8	4.4	1.4	1
4 (Belleville)	7	3.5	2	1.3
5 (Marion)	7.2	3.6	1.7	1.1

n_{gasket} = Number of gaskets installed

Illinois EE Policy Manual, applicable net-to-gross adjustments to the savings will be determined as part of the annual SAG net-to-gross process. During update cycle for version v.12, applied the percent change of NCEI Annual Normals HDD60 from 30 yr data set (1981-2010) to more recent 15 yr data (2006-2020) for all heating-related adjustment values.

¹⁴⁷⁶ Prescriptive savings are based upon “Evaluation of the Weatherization Residential Assistance Partnership and Helps Programs (WRAP/Helps).” Middletown, CT: KEMA, 2010. Accessed July 30, 2015, and adjusted for relative HDD of Bridgeport/Hartford CT with the IL climate zones. See ‘Rx Airsealing HDD adjustment.xls’ for more information. Cooling savings derived using savings assumptions pulled from ASHRAE, 2001 AHSRAE Handbook – Fundamentals, Chapter 26, Table 1. Effective Air Leakage Areas (Low-Rise Residential Applications Only). See ‘Prescriptive Air Sealing Cooling Calculation.xls’ for details.

$\Delta kWh_{\text{windows}}$ = Annual kWh savings from installation of Shrink-Fit Window Kit¹⁴⁷⁷

Climate Zone (City based upon)	$\Delta kWh_{\text{windows_heat}} / \text{sf}$	
	Electric Resistance	Heat Pump
1 (Rockford)	4	2.1
2 (Chicago)	3.9	2
3 (Springfield)	3.3	1.7
4 (Belleville)	2.5	1.3
5 (Marion)	2.6	1.3

$\text{sf}_{\text{windows}}$ = square footage of shrink-fit window film

$\Delta kWh_{\text{sweep}}$ = Annual kWh savings from installation of a door sweep on a door between conditioned and unconditioned space

Climate Zone (City based upon)	$\Delta kWh_{\text{sweep_heat}} / \text{sweep}$		$\Delta kWh_{\text{sweep_cool}} / \text{sweep}$	
	Electric Resistance	Heat Pump	With Cooling	Unknown Cooling
1 (Rockford)	202.4	101.2	3.9	2.6
2 (Chicago)	195.3	97.6	4.6	3
3 (Springfield)	169.3	84.7	5.7	3.7
4 (Belleville)	134.9	67.5	7.8	5.1
5 (Marion)	137.9	68.9	6.6	4.3

n_{sweep} = Number of sweeps installed

$\Delta kWh_{\text{sealing}}$ = Annual kWh savings from foot of caulking, sealing, or polyethylene tape in locations between conditioned and unconditioned space.

Climate Zone (City based upon)	$\Delta kWh_{\text{sealing_heat}} / \text{ft}$		$\Delta kWh_{\text{sealing_cool}} / \text{ft}$	
	Electric Resistance	Heat Pump	With Cooling	Unknown Cooling
1 (Rockford)	11.6	5.8	0.11	0.07
2 (Chicago)	11.2	5.6	0.12	0.08
3 (Springfield)	9.7	4.8	0.15	0.1
4 (Belleville)	7.7	3.9	0.21	0.14
5 (Marion)	7.9	3.9	0.18	0.12

l_{sealing} = linear feet of caulking, sealing, or polyethylene tape

ΔkWh_{wx} = Annual kWh savings from window weatherstripping or door weatherstripping

¹⁴⁷⁷ Prescriptive savings are based upon “Cost Benefit Analysis for 2018, Annual Report submitted to Virginia Natural Gas, Inc., submitted by Nexant.” July 31, 2018. Adjusted for relative HDD of Virginia Beach VA with the IL climate zones. See “Window Film Savings Calculation.xlsx” for more information.

Climate Zone (City based upon)	$\Delta kWh_{WX_heat} / ft$		$\Delta kWh_{WX_cool} / ft$	
	Electric Resistance	Heat Pump	With Cooling	Unknown Cooling
1 (Rockford)	13.5	6.7	0.1	0.06
2 (Chicago)	13	6.5	0.12	0.08
3 (Springfield)	11.3	5.6	0.14	0.09
4 (Belleville)	9	4.5	0.2	0.13
5 (Marion)	9.2	4.6	0.16	0.11

$l_{f_{WX}}$ = Linear feet of window weatherstripping or door weatherstripping

$ADJ_{RxAirsealing}$ = Adjustment for air sealing savings to account for prescriptive estimates overclaiming savings¹⁴⁷⁸
 = 80%

ISR = In service rate of weatherization kits dependant on install method as listed in table below.¹⁴⁷⁹

¹⁴⁷⁸ Though we do not have a specific evaluation to point to, modeled savings have often been found to overclaim. Further VEIC reviewed these deemed estimates and consider them to likely be a high estimate. As such an 80% adjustment is applied, and this could be further refined with future evaluations.

¹⁴⁷⁹ For any airsealing kit measure, if research indicates that a certain percentage of participants who indicated during the original ISR survey that they plan to install are found to have actually installed at a later date, these future installs can be claimed as 2nd or 3rd year installs through an errata.

Selection	ISR
Distributed School Weatherization Kits	0.57 ¹⁴⁸⁰
Distributed Self-Install Income-Qualified Kits ¹⁴⁸¹	
Weatherstripping	0.63
Outlet and Switch Gaskets	0.40 ¹⁴⁸²
Window Kit	0.57
Door sweep	0.62 ¹⁴⁸³
Other Distributed Self-Install Income-Qualified Measures	0.67 ¹⁴⁸⁴
Opt-in Weatherization Kits ¹⁴⁸⁵	
V-seal weatherstripping	0.68
Cell foam tape weatherstripping	0.72
Rope Caulk	0.60
Switch and outlet gaskets	0.76
Door sweep	0.68
Other Self-Install Weatherization Measures	0.69
Direct Install, Retail	1.0

¹⁴⁸⁰ Results from Home Energy Worksheets completed by student/families in 2020, 2021, and 2022 were nearly the same as values from: LLUME Advising LLC. School-Based Energy Education Programs: Goals, Challenges, and Opportunities. October 2015. See result for AEP Ohio Weather stripping/door sweep/gaskets kit in table on page 17. Home Energy Worksheets also establish the fraction of participants who indicate they “will install later” for specific measures. Follow-up research completed by Guidehouse for Nicor Gas in 2022 found that, on average, 51.3% of respondents who initially reported that they hadn’t installed specific kit measures, but “planned to” subsequently had installed the measures. Combining these findings allows for an ISR that accounts for initial and one round of subsequent installations. To maintain a conservative estimate of ISR, the remaining 48.7% are presumed uninstalled. See: EESchoolKitSubsequentInstall_HEW.xlsx for data and calculations.

¹⁴⁸¹ Guidehouse. Income Eligible Gas Kits ISR Special Study Results. June 16, 2020.

¹⁴⁸² Research from 2021 Ameren Illinois Income Qualified participant survey, available on IL SAG website: <https://ilsag.s3.amazonaws.com/AIC-Income-Qualified-Initiative-Participant-Survey-Results-Memo-FINAL-2022-02-01.pdf>

¹⁴⁸³ Research from 2021 Ameren Illinois Income Qualified participant survey, available on IL SAG website: <https://ilsag.s3.amazonaws.com/AIC-Income-Qualified-Initiative-Participant-Survey-Results-Memo-FINAL-2022-02-01.pdf>

¹⁴⁸⁴ Straight average of other measures.

¹⁴⁸⁵ Table 16, Illinois TRM Workpaper ESK ISR Follow-up Survey 2023-05-30

For example, 5 gaskets, 2 door sweeps and 10 linear feet of window weatherstripping is provided in a Distributed Self-Install Income-Qualified Kits for a home in Rockford with electric resistance and cooling

$$\Delta kWh = (\Delta kWh_{\text{Heating}} + \Delta kWh_{\text{Cooling}}) * ADJ_{R_{\text{Airsealing}}}$$

$$\Delta kWh_{\text{Heating}} = (\Delta kWh_{\text{gasket_heat}} * n_{\text{gasket}} * ISR + \Delta kWh_{\text{windows_heat}} * sf_{\text{windows}} * ISR + \Delta kWh_{\text{sweep_heat}} * n_{\text{sweep}} * ISR + \Delta kWh_{\text{sealing_heat}} * lf_{\text{sealing}} * ISR + \Delta kWh_{\text{WX_heat}} * lf_{\text{WX}} * ISR)$$

$$\Delta kWh_{\text{Cooling}} = (\Delta kWh_{\text{gasket_cool}} * n_{\text{gasket}} * ISR + \Delta kWh_{\text{windows_cool}} * sf_{\text{windows}} * ISR + \Delta kWh_{\text{sweep_cool}} * n_{\text{sweep}} * ISR + \Delta kWh_{\text{sealing_cool}} * lf_{\text{sealing}} * ISR + \Delta kWh_{\text{WX_cool}} * lf_{\text{WX}} * ISR)$$

$$\begin{aligned} \Delta kWh_{\text{Heating}} &= (10.5 * 5 * 0.4) + (202.4 * 2 * 0.62) + (13.5 * 10 * 0.63) \\ &= 357.0 \text{ kWh} \end{aligned}$$

$$\begin{aligned} \Delta kWh_{\text{Cooling}} &= (1 * 5 * 0.4) + (3.9 * 2 * 0.62) + (0.1 * 10 * 0.63) \\ &= 7.5 \text{ kWh} \end{aligned}$$

$$\begin{aligned} \Delta kWh &= (357.0 + 7.5) * 0.8 \\ &= 291.6 \text{ kWh} \end{aligned}$$

SUMMER COINCIDENT PEAK DEMAND SAVINGS

$$\Delta kW = (\Delta kWh_{\text{cooling}} / FLH_{\text{cooling}}) * CF$$

Where:

$\Delta kWh_{\text{cooling}}$ = Cooling savings from measure

FLH_{cooling} = Full load hours of air conditioning

= Dependent on location:¹⁴⁸⁶

Climate Zone (City based upon)	Single Family	Multifamily
1 (Rockford)	547	499
2 (Chicago)	709	629
3 (Springfield)	779	707
4 (Belleville)	1,082	982
5 (Marion/Murphysboro)	956	868
Weighted Average ¹⁴⁸⁷	676	603

¹⁴⁸⁶ Full load hours for Chicago, Moline and Rockford are provided in “Final Evaluation Report: Central Air Conditioning Efficiency Services (CACES), 2010, Navigant Consulting”, p.33. An average FLH/Cooling Degree Day (from NCDC) ratio was calculated for these locations and applied to the CDD of the other locations in order to estimate FLH. During update cycle for version v.12, applied percent change of CDD65, NCEI Annual Normals from 30 yr data set (1981-2010) to more recent 15 yr data (2006-2020) to all FLHcool values.

¹⁴⁸⁷ Weighting for Ameren is based on electric accounts in each of the cooling zones. Weighting for ComEd and Statewide average is based on number of occupied residential housing units in each zone. ComEd is weighted average of Zones 1-2. Alternative program-weighted assumptions can be used if appropriate.

Climate Zone (City based upon)	Single Family	Multifamily
ComEd	875	791
Ameren	731	655
Statewide		

Use Multifamily if: Building meets utility’s definition for multifamily and HVAC system serves single unit. For residential sized systems serving 2 or more units, assume single family hours.

CF_{SSP} = Summer System Peak Coincidence Factor for Central A/C (during utility peak hour)
= 68%¹⁴⁸⁸

CF_{SSP SF} = Summer System Peak Coincidence Factor for Heat Pumps in single-family homes (during system peak hour)
= 72%¹⁴⁸⁹

CF_{SSP, MF} = Summer System Peak Coincidence Factor for Heat Pumps in multi-family homes (during system peak hour)
= 67%¹⁴⁹⁰

CF_{PJM} = PJM Summer Peak Coincidence Factor for Central A/C (average during PJM peak period)
= 46.6%¹⁴⁹¹

CF_{PJM SF} = PJM Summer Peak Coincidence Factor for Heat Pumps in single-family homes (average during PJM peak period)
= 46.6%¹⁴⁹²

CF_{PJM, MF} = PJM Summer Peak Coincidence Factor for Heat Pumps in multi-family homes (average during peak period)
= 28.5%

Other factors as defined above.

For example: energy savings from air sealing. Energy savings for attic insulation are included in a separate example in Section 5.6.5: Ceiling/Attic Insulation.

Assume a well shielded, 2-story non-income eligible single family home in Chicago completes air sealing, installs attic insulation, has 10.5 SEER central cooling and a heat pump with COP of 2.0, and has pre and post blower door test results of 3,400 and 2,250 CFM:

$$\begin{aligned} \Delta kW_{SSP} &= 257 / 709 * 0.68 \\ &= 0.25 \text{ kW} \end{aligned}$$

$$\begin{aligned} \Delta kW_{PJM} &= 257 / 709 * 0.466 \\ &= 0.17 \text{ kW} \end{aligned}$$

¹⁴⁸⁸ Based on metering of 24 homes with central AC during PY4 and PY5 in Ameren Illinois service territory.

¹⁴⁸⁹ Based on analysis of metering results from 24 heat pumps in Ameren Illinois service territory in PY5 coincident with AIC’s 2010 system peak; ‘Impact and Process Evaluation of Ameren Illinois Company’s Residential HVAC Program (PY5)’.

¹⁴⁹⁰ Multifamily coincidence factors both from; *All-Electric Homes PY6 Metering Results: Multifamily HVAC Systems*, Cadmus, October 2015

¹⁴⁹¹ Based on analysis of Itron eShape data for Missouri, calibrated to Illinois loads, supplied by Ameren. The average AC load over the PJM peak period (1-5pm, M-F, June through August) is divided by the maximum AC load during the year.

¹⁴⁹² Based on analysis of Itron eShape data for Missouri, calibrated to Illinois loads, supplied by Ameren. The average AC load over the PJM peak period (1-5pm, M-F, June through August) is divided by the maximum AC load during the year.

FOSSIL FUEL SAVINGS

Methodology 1: Blower Door Test

Required methodology when blower door testing is conducted.

If Fossil Fuel heating:

$$\Delta\text{Therms} = \frac{((\text{CFM50}_{\text{existing}} - \text{CFM50}_{\text{new}}) / \text{N}_{\text{heat}}) * 60 * 24 * \text{HDD} * 0.018}{\text{ADJ}_{\text{AirSealingFossilHeat}} * \text{IE}_{\text{NetCorrection}} * \% \text{FossilHeat}} / (\eta_{\text{Heat}} * 100,000) *$$

Where:

N_{heat} = Conversion factor from leakage at 50 Pascal to leakage at natural conditions
 = Based on climate zone and building height:¹⁴⁹³

Climate Zone (City based upon)	N_heat (by # of stories)			
	1	1.5	2	3
1 (Rockford)	23.8	21.1	19.3	17.1
2 (Chicago)	23.9	21.1	19.4	17.2
3 (Springfield)	24.2	21.5	19.7	17.4
4 (St Louis, MO)	25.4	22.5	20.7	18.3
5 (Paducah, KY)	27.8	24.6	22.6	20.0

HDD = Heating Degree Days
 = dependent on location:¹⁴⁹⁴

Climate Zone (City based upon)	HDD 60
1 (Rockford)	5230
2 (Chicago)	4798
3 (Springfield)	4266
4 (Belleville)	3188
5 (Marion/Murphysboro)	3390

η_{Heat} = Efficiency of heating system
 = Equipment efficiency * distribution efficiency
 = Actual (where it is possible to measure or reasonably estimate).¹⁴⁹⁵ Note where new HVAC is installed in addition to shell measures, the old HVAC unit efficiency should be used and the shell measure savings calculated first, the HVAC measure then assuming the reduced heat/cooling loads. If using rated efficiencies, derate efficiency value by 1% per

¹⁴⁹³ N-factor is used to convert 50-pascal blower door air flows to natural air flows and is dependent on geographic location and # of stories. These were developed by applying the LBNL infiltration model (see LBNL paper 21040, *Exegisis of Proposed ASHRAE Standard 119: Air Leakage Performance for Detached Single-Family Residential Buildings*; Sherman, 1986; page v-vi, Appendix page 7-9) to the reported wind speeds and outdoor temperatures provided by the NRDC 30 year climate normals. For more information see Bruce Harley, CLEAResult "Infiltration Factor Calculations Methodology.doc". Note, the methodology for developing n-factors requires hourly normals as opposed to annual normals which are used for other assumptions in the TRM. Hourly normals were not available for all sites used for other climate assumptions and so the nearest locations were used (St Louis, MO for Belleville, IL and Paducah, KY for Marion, IL).

¹⁴⁹⁴ National Climatic Data Center, National Centers for Environmental Information (NCEI) Annual Normals, from 2006 - 2020, calculated with a base temp of 60°F

¹⁴⁹⁵ Ideally, the System Efficiency should be obtained either by recording the AFUE of the unit, or performing a steady state efficiency test. The Distribution Efficiency can be estimated via a visual inspection and by referring to a look up table such as that provided by the Building Performance Institute: (see 'BPI Distribution Efficiency Table') or by performing duct blaster testing.

year (maximum of 30 years) to account for degradation over time,¹⁴⁹⁶ or if Equipment Efficiency is not available, use Section 5.3 to select the appropriate equipment efficiency for the project. If unknown value is used, it should not be derated by age. If actual Distribution Efficiency is not available, use 85%.

ADJ_{AirSealingFossilHeat} = Adjustment for fossil heating savings to account for inaccuracies in engineering algorithms:¹⁴⁹⁷

Measure	ADJ _{AirSealingFossilHeat}
Air sealing and attic insulation	76%
Air sealing without attic insulation	100%

IE_{NetCorrection} = 100% if not income eligible or air sealing is installed without attic insulation
 = 110% if installing air sealing and attic insulation in income eligible projects with a deemed NTG value of 1.0 to offset net savings adjustment inherent when using ADJ_{AirSealingFossilHeat} of 76%¹⁴⁹⁸

%FossilHeat = Percent of homes that have fossil fuel space heating
 = 100 % for Fossil Fuel heating
 = 0 % for Electric Resistance or Heat Pump
 = If unknown¹⁴⁹⁹, use the following table:

Utility	Location				
	Single Family	Single Family Low Income	Multi Family	Multi Family Low Income	Unknown
Ameren	82%	74%	62%	61%	71%
ComEd	86%	78%	57%	52%	79%
PGL	98.9%	98.5%	96.0%	96.9%	97.7%
NSG	98.3%	99.2%	67.5%	98.8%	96.6%
Nicor	98.3%	99.2%	67.5%	98.8%	96.6%
All DUs ¹⁵⁰⁰					74%

¹⁴⁹⁶ Justification for degradation factors can be found on page 14 of ‘AIC HVAC Metering Study Memo FINAL 2_28_2018’. Estimate efficiency as (Rated Efficiency * (1-0.01)^{Equipment Age}).

¹⁴⁹⁷ As demonstrated in air sealing and insulation research by Navigant, see Navigant (2018). *ComEd and Nicor Gas Air Sealing and Insulation Research Report*. Presented to Commonwealth Edison Company and Nicor Gas Company. These adjustment factors are based on a consumption data analysis using matching to non-participants. The values are therefore between net and gross with respect to free ridership. Like all consumption data analyses, they are net with respect to participant spillover and gross with respect to non-participant spillover. For more detail, see Table 5-3 in Volume 4 of the IL-TRM. Consistent with Section 7.2 of the Illinois EE Policy Manual, applicable net-to-gross adjustments to the savings will be determined as part of the annual SAG net-to-gross process. During update cycle for version v.12, applied the percent change of NCEI Annual Normals HDD60 from 30 yr data set (1981-2010) to more recent 15 yr data (2006-2020) for all cooling-related adjustment values.

¹⁴⁹⁸ The additional value of 10% was selected to acknowledge that some portion of the regression-derived adjustment factors accounts for gross impact effects, and that removing net effects embedded in the adjustment factors would increase savings to some degree. A review of historical NTG values for air sealing and insulation measures in non-income eligible populations did not provide definitive guidance for estimating the net component of the adjustment factors. Historically, free ridership has ranged from 9% to 26% for like measures, and spillover has ranged from 1% to 14%, while NTGs have ranged from 0.75 to 1.05. The midpoint of the NTG range would be 0.90, a 10% reduction from 1.0.

¹⁴⁹⁹ Based on the average % Natural Gas used for space heating in Unknown residential structure types across all utilities covered by the IL program. Residence types include: SF, SF LI, MF & MF LI. Utilities included: Ameren, ComEd, People’s Gas, Northshore Gas & Nicor. Data provided from 2016 Ameren Illinois Demand Side Management (DSM) Market Potential Study by Applied Energy Group, ComEd’s 2019 Baseline Survey on residential space heating share, and PY2022-2023 Implementation Contractors Data for People’s Gas, Northshore Gas & Nicor .

¹⁵⁰⁰ For the weighted average calculations, please see the Analysis file. PGL, NSG, Nicor & gas customers were assumed to follow

Note: If a measure is supported by a gas and electric utility through a joint program, and it is unknown whether the participant has a gas supply, the electric utility values in the table above should be used. If it is known that the participant has a gas supply, the values from the gas utility above should be applied.

Other factors as defined above.

For example, energy savings from air sealing. Energy savings for attic insulation are included in a separate example in Section 5.6.5: Ceiling/Attic Insulation.

Assume a 2-story non-income eligible single family home in Chicago completes air sealing, installs attic insulation, has a gas furnace with system efficiency of 72%, and has pre and post blower door test results of 3,400 and 2,250 CFM:

$$\Delta\text{Therms} = (((3,400 - 2,250)/19.4) * 60 * 24 * 4,798 * 0.018) / (0.72 * 100,000) * 76\% * 100\%$$

$$= 77.8 \text{ therms}$$

Methodology 2: Prescriptive Infiltration Reduction Measures¹⁵⁰¹

Savings shall only be calculated via Methodology 2 when a blower door test is not conducted.

$$\Delta\text{therms} = (\Delta\text{therms}_{\text{gasket}} * n_{\text{gasket}} * \text{ISR} + \Delta\text{therms}_{\text{windows}} * sf_{\text{windows}} * \text{ISR} + \Delta\text{therms}_{\text{sweep}} * n_{\text{sweep}} * \text{ISR} + \Delta\text{therms}_{\text{sealing}} * lf_{\text{sealing}} * \text{ISR} + \Delta\text{therms}_{\text{WX}} * lf_{\text{WX}} * \text{ISR}) * \text{ADJ}_{\text{RxAirsealing}}$$

Where:

$\Delta\text{therms}_{\text{gasket}}$ = Annual therm savings from installation of air sealing gasket on an electric outlet on an external wall.

Climate Zone (City based upon)	$\Delta\text{therms}_{\text{gasket}} / \text{gasket}$ Fossil Heat
1 (Rockford)	0.49
2 (Chicago)	0.47
3 (Springfield)	0.41
4 (Belleville)	0.33
5 (Marion)	0.33

n_{gasket} = Number of gaskets installed

$\Delta\text{therms}_{\text{windows}}$ = Annual therm savings from installation of Shrink-Fit Window Kit:¹⁵⁰²

Climate Zone (City based upon)	$\Delta\text{therms}_{\text{windows}} / \text{sf}$ Fossil Heat
1 (Rockford)	0.191
2 (Chicago)	0.183
3 (Springfield)	0.156

the provided split. ComEd total customers, minus overlap with PGL,NSG & Nicor, therefore gas only homes. Ameren is total customers minus Nicor.

¹⁵⁰¹ Prescriptive savings are based upon “Evaluation of the Weatherization Residential Assistance Partnership and Helps Programs (WRAP/Helps).” Middletown, CT: KEMA, 2010. Accessed July 30, 2015, and adjusted for relative HDD of Bridgeport/Hartford CT with the IL climate zones. See ‘Rx Airsealing HDD adjustment.xls’ for more information.

¹⁵⁰² Prescriptive savings are based upon “Cost Benefit Analysis for 2018, Annual Report submitted to Virginia Natural Gas, Inc., submitted by Nexant.” July 31, 2018. Adjusted for relative HDD of Virginia Beach VA with the IL climate zones. See “Window Film Savings Calculation.xlsx” for more information.

4 (Belleville)	0.121
5 (Marion)	0.123

$sf_{windows}$ = square footage of shrink-fit window film

$\Delta therm_{S_{sweep}}$ = Annual therm savings from installation of door sweep on a door between conditioned and unconditioned space

Climate Zone (City based upon)	$\Delta therm_{S_{sweep}}$ / sweep Fossil Heat
1 (Rockford)	9.46
2 (Chicago)	9.13
3 (Springfield)	7.92
4 (Belleville)	6.31
5 (Marion)	6.45

n_{sweep} = Number of sweeps installed

$\Delta therm_{S_{sealing}}$ = Annual therm savings from foot of caulking, sealing, or polyethylene tape in locations between conditioned and unconditioned space.

Climate Zone (City based upon)	$\Delta therm_{S_{sealing}}$ / ft Fossil Heat
1 (Rockford)	0.54
2 (Chicago)	0.52
3 (Springfield)	0.45
4 (Belleville)	0.36
5 (Marion)	0.37

$lf_{sealing}$ = linear feet of caulking, sealing, or polyethylene tape

$\Delta therm_{S_{wx}}$ = Annual therm savings from window weatherstripping or door weatherstripping

Climate Zone (City based upon)	$\Delta therm_{S_{wx}}$ / ft Fossil Heat
1 (Rockford)	0.63
2 (Chicago)	0.61
3 (Springfield)	0.53
4 (Belleville)	0.42
5 (Marion)	0.43

lf_{wx} = Linear feet of window weatherstripping or door weatherstripping

$ADJ_{RxAirsealing}$ = Adjustment for air sealing savings to account for prescriptive estimates overclaiming savings¹⁵⁰³

= 80%

Other assumptions as defined above

¹⁵⁰³ Though we do not have a specific evaluation to point to, modeled savings have often been found to overclaim. Further VEIC reviewed these deemed estimates and consider them to likely be a high estimate. As such an 80% adjustment is applied, and this could be further refined with future evaluations.

Mid-Life adjustment

In order to account for the likely replacement of existing heating and cooling equipment during the life time of this measure, a mid-life adjustment should be applied. To calculate the adjustment, re-calculate the savings above using the following new baseline system efficiency assumptions:

Efficiency Assumption	System Type	New Baseline Efficiency
ηCool	Central AC	13.4 SEER2
	Heat Pump	14.3 SEER2
ηHeat	Electric Resistance	1.0 COP
	Heat Pump (7.5HSPF/3.413)*0.85	1.87 COP
	Gas Furnace 80% AFUE * 0.85	68% AFUE
	Oil Furnace 83% AFUE * 0.85	71% AFUE
	Gas Boiler	84% AFUE
	Oil Boiler	86% AFUE

This reduced annual savings should be applied following the assumed remaining useful life of the existing equipment, estimate to be 10 years or 13 years for boilers.¹⁵⁰⁴ Note if the existing equipment efficiency is greater than the new baseline efficiency listed above, do not apply a mid-life adjustment.

WATER IMPACT DESCRIPTIONS AND CALCULATION

N/A

DEEMED O&M COST ADJUSTMENT CALCULATION

N/A

MEASURE CODE: RS-SHL-AIRS-V14-250101

REVIEW DEADLINE: 1/1/2028

¹⁵⁰⁴ This is intentionally longer than the assumptions found in the early replacement measures as the application of this measure will occur in a variety of homes that will not be targeted for early replacement HVAC systems.

5.6.2 Basement Sidewall Insulation

DESCRIPTION

Insulation is added to a basement or crawl space. Insulation added above ground in conditioned space is modeled the same as wall insulation. Below ground insulation is adjusted with an approximation of the thermal resistance of the ground. Insulation in unconditioned spaces is modeled by reducing the degree days to reflect the smaller but non-zero contribution to heating and cooling load. Cooling savings only consider above grade insulation, as below grade has little temperature difference during the cooling season.

This measure was developed to be applicable to the following program types: RF.

If applied to other program types, the measure savings should be verified.

DEFINITION OF EFFICIENT EQUIPMENT

This measure requires a member of the implementation staff or a participating contractor to evaluate the pre and post R-values and measure surface areas. The requirements for participation in the program will be defined by the utilities.

DEFINITION OF BASELINE EQUIPMENT

The existing condition will be evaluated by implementation staff or a participating contractor and is likely to be no basement wall or ceiling insulation.

DEEMED LIFETIME OF EFFICIENT EQUIPMENT

The expected measure life is assumed to be 30 years.¹⁵⁰⁵

Note a mid-life adjustment to account for replacement of HVAC equipment during the measure life should be applied after 10 years or 13 years for boilers.¹⁵⁰⁶ See section below for detail.

DEEMED MEASURE COST

The actual installed cost for this measure should be used in screening.

DEEMED O&M COST ADJUSTMENTS

N/A

LOADSHAPE

- Loadshape R08 - Residential Cooling
- Loadshape R09 - Residential Electric Space Heat
- Loadshape R10 - Residential Electric Heating and Cooling

COINCIDENCE FACTOR

The summer peak coincidence factor for cooling is provided in two different ways below. The first is used to estimate peak savings during the utility peak hour and is most indicative of actual peak benefits, and the second represents the *average* savings over the defined summer peak period, and is presented so that savings can be bid into PJM's capacity market.

CF_{SSP} = Summer System Peak Coincidence Factor for Central A/C (during utility peak hour)

¹⁵⁰⁵ As recommended in Guidehouse 'EMV Group A, Deliverable 16 EUL Research – Residential Insulation', prepared for California Public Utilities Commission, June 2021.

¹⁵⁰⁶ This is intentionally longer than the assumptions found in the early replacement measures as the application of this measure will occur in a variety of homes that will not be targeted for early replacement HVAC systems.

	= 68% ¹⁵⁰⁷
CF _{SSP SF}	= Summer System Peak Coincidence Factor for Heat Pumps in single family homes (during system peak hour) = 72% ¹⁵⁰⁸
CF _{SSP, MF}	= Summer System Peak Coincidence Factor for Heat Pumps in multifamily homes (during system peak hour) = 67% ¹⁵⁰⁹
CF _{PJM}	= PJM Summer Peak Coincidence Factor for Central A/C (average during PJM peak period) = 46.6% ¹⁵¹⁰
CF _{PJM SF}	= PJM Summer Peak Coincidence Factor for Heat Pumps in single family homes (average during PJM peak period) = 46.6% ¹⁵¹¹
CF _{PJM, MF}	= PJM Summer Peak Coincidence Factor for Heat Pumps in multifamily homes (average during peak period) = 28.5%

Algorithm

CALCULATION OF SAVINGS

ELECTRIC ENERGY SAVINGS

Where available savings from shell insulation measures should be determined through a custom analysis. When that is not feasible for the program the following engineering algorithms can be used with the inclusion of an adjustment factor to de-rate the heating savings.

$$\Delta kWh = (\Delta kWh_{cooling} + \Delta kWh_{heatingElectric} + \Delta kWh_{heatingFurnace})$$

Where:

$$\begin{aligned} \Delta kWh_{cooling} &= \text{If central cooling, reduction in annual cooling requirement due to insulation} \\ &= \left(\left(\left(\frac{1}{R_{old_AG}} - \frac{1}{(R_{added} + R_{old_AG})} \right) * L_{basement_wall_total} * \right. \right. \\ &\quad \left. \left. H_{basement_wall_AG} * (1 - \text{Framing_factor}) * 24 * CDD * DUA \right) / (1000 * \eta_{Cool}) \right) * \\ &\quad ADJ_{BasementCool} * \%Cool \end{aligned}$$

R_{added} = R-value of additional spray foam, rigid foam, or cavity insulation.

R_{old_AG} = R-value value of foundation wall above grade.

¹⁵⁰⁷ Based on metering of 24 homes with central AC during PY4 and PY5 in Ameren Illinois service territory.

¹⁵⁰⁸ Based on analysis of metering results from 24 heat pumps in Ameren Illinois service territory in PY5 coincident with AIC's 2010 system peak; 'Impact and Process Evaluation of Ameren Illinois Company's Residential HVAC Program (PY5)'.

¹⁵⁰⁹ Multifamily coincidence factors both from; *All-Electric Homes PY6 Metering Results: Multifamily HVAC Systems*, Cadmus, October 2015

¹⁵¹⁰ Based on analysis of Itron eShape data for Missouri, calibrated to Illinois loads, supplied by Ameren. The average AC load over the PJM peak period (1-5pm, M-F, June through August) is divided by the maximum AC load during the year.

¹⁵¹¹ Based on analysis of Itron eShape data for Missouri, calibrated to Illinois loads, supplied by Ameren. The average AC load over the PJM peak period (1-5pm, M-F, June through August) is divided by the maximum AC load during the year.

- = Actual, if unknown assume 1.0.¹⁵¹²
- L_basement_wall_total = Length of basement wall around the entire insulated perimeter (ft)
- H_basement_wall_AG = Height of insulated basement wall above grade (ft)
- Framing_factor = Adjustment to account for area of framing when cavity insulation is used
 - = 0% if Spray Foam or External Rigid Foam
 - = 25% if studs and cavity insulation¹⁵¹³
- 24 = Converts hours to days
- CDD = Cooling Degree Days
 - = Dependent on location and whether basement is conditioned:¹⁵¹⁴

Climate Zone (City based upon)	Conditioned CDD 65	Unconditioned (CDD 75) ¹⁵¹⁵
1 (Rockford)	877	326
2 (Chicago)	1047	354
3 (Springfield)	1183	448
4 (Belleville)	1641	532
5 (Marion)	1450	516
Weighted Average ¹⁵¹⁶	1098	380

- DUA = Discretionary Use Adjustment (reflects the fact that people do not always operate their AC when conditions may call for it).
 - = 0.75¹⁵¹⁷
- 1000 = Converts Btu to kBtu
- ηCool = Seasonal Energy Efficiency Ratio of cooling system (kBtu/kWh)
 - = Actual (where it is possible to measure or reasonably estimate). Note where new HVAC is installed in addition to shell measures, the old HVAC unit efficiency should be used and the shell measure savings calculated first, the HVAC measure then assuming the reduced heat/cooling loads. If using rated efficiencies, derate efficiency value by 1% per year (maximum of 30 years) to account for degradation over time,¹⁵¹⁸ or if unknown assume the following.¹⁵¹⁹ If unknown value is used, it should not be derated by age.

¹⁵¹² ORNL Builders Foundation Handbook, crawl space data from Table 5-5: Initial Effective R-values for Uninsulated Foundation System and Adjacent Soil, 1991.

¹⁵¹³ ASHRAE, 2001, "Characterization of Framing Factors for New Low-Rise Residential Building Envelopes (904-RP)," Table 7.1

¹⁵¹⁴ National Centers for Environmental Information (NCEI) Annual Normals, from 2006 - 2020, calculated with a base temp of 65°F. There is a county mapping table in Volume 1, Section 3.7 providing the appropriate city to use for each county of Illinois.

¹⁵¹⁵ Five year-average (2018 to 2022) cooling degree days with a base temperature of 75 F. Data from DegreeDays.net were used in this table because the climate normals from NCEI/NCDC used elsewhere are not available at base temps above 72F.

¹⁵¹⁶ Weighted based on number of occupied residential housing units in each zone (US Census 2010).

¹⁵¹⁷ This factor's source is: Energy Center of Wisconsin, May 2008 metering study; "Central Air Conditioning in Wisconsin, A Compilation of Recent Field Research", p31.

¹⁵¹⁸ Justification for degradation factors can be found on page 14 of 'A/C HVAC Metering Study Memo FINAL 2_28_2018'. Estimate efficiency as (Rated Efficiency * (1-0.01)^Equipment Age).

¹⁵¹⁹ These default system efficiencies are based on the applicable minimum Federal Standards. In 2006 the Federal Standard for Central AC was adjusted. While one would expect the average system efficiency to be higher than this minimum, the likely

Age of Equipment	ηCool Estimate
Before 2006	9.5
2006 - 2014	12.4
Central AC After 1/1/2015	12.4
Heat Pump After 1/1/2015	13.3
Unknown (for use in program evaluation only)	10.0

ADJ_{BasementCool} = Adjustment for cooling savings from basement wall insulation to account for prescriptive engineering algorithms overclaiming savings¹⁵²⁰
 = 75%

%Cool = Percent of homes that have cooling

Central Cooling?	%Cool
Yes	100%
No	0%
Unknown (for use in program evaluation only) ¹⁵²¹	66%

ΔkWh_{heatingElectric} = If electric heat (resistance or heat pump), reduction in annual electric heating due to insulation

$$= [(((1/R_{old_AG} - 1/(R_{added}+R_{old_AG})) * L_{basement_wall_total} * H_{basement_wall_AG} * (1-Framing_factor)) + ((1/R_{old_BG} - 1/(R_{added}+R_{old_BG})) * L_{basement_wall_total} * (H_{basement_wall_total} - H_{basement_wall_AG}) * (1-Framing_factor)))] * 24 * HDD / (3,412 * \eta_{Heat}) * ADJ_{BasementHeat} * \%ElectricHeat$$

Where:

R_{old_BG} = R-value value of foundation wall below grade (including thermal resistance of the earth)¹⁵²²
 = dependent on depth of foundation (H_{basement_wall_total} – H_{basement_wall_AG}):
 = Actual R-value of wall plus average earth R-value by depth in table below

Below Grade R-value									
Depth below grade (ft)	0	1	2	3	4	5	6	7	8
Earth R-value (°F-ft ² -h/Btu)	2.44	4.50	6.30	8.40	10.44	12.66	14.49	17.00	20.00
Average Earth R-value (°F-ft ² -h/Btu)	2.44	3.47	4.41	5.41	6.42	7.46	8.46	9.53	10.69
Total BG R-value (earth + R-1.0 foundation) default	3.44	4.47	5.41	6.41	7.42	8.46	9.46	10.53	11.69

degradation of efficiencies over time means that using the minimum standard is appropriate. Note all ratings have been converted to SEER2 equivalents – since the new rating better reflects the actual efficiency of the units.

¹⁵²⁰ As demonstrated in two years of metering evaluation by Opinion Dynamics, see Memo “Results for AIC PY6 HPwES Billing Analysis”, dated February 20, 2015. TAC negotiated adjustment factor is 80%. During update cycle for version v.12, applied the percent change of NCEI Annual Normals CDD65 from 30 yr data set (1981-2010) to more recent 15 yr data (2006-2020) for all cooling-related adjustment values.

¹⁵²¹ Percentage of homes in Illinois that have central cooling from “Table HC7.9 Air Conditioning in Homes in Midwest Region, Divisions, and States, 2009” from Energy Information Administration, 2009 Residential Energy Consumption Survey

¹⁵²² Adapted from Table 1, page 24.4, of the 1977 ASHRAE Fundamentals Handbook

H_basement_wall_total = Total height of basement wall (ft)

HDD = Heating Degree Days

= dependent on location and whether basement is conditioned:¹⁵²³

Climate Zone (City based upon)	Conditioned HDD 60	Unconditioned HDD 50
1 (Rockford)	5230	3233
2 (Chicago)	4798	2845
3 (Springfield)	4266	2456
4 (Belleville)	3188	1651
5 (Marion/Murphysboro)	3390	1750
Weighted Average ¹⁵²⁴	4631	2732

η_{Heat} = Efficiency of heating system

= Actual (where it is possible to measure or reasonably estimate). Note where new HVAC is installed in addition to shell measures, the old HVAC unit efficiency should be used and the shell measure savings calculated first, the HVAC measure then assuming the reduced heat/cooling loads. If using rated efficiencies, derate efficiency value by 1% per year (maximum of 30 years) to account for degradation over time,¹⁵²⁵ or if not available refer to default table below.¹⁵²⁶ If unknown value is used, it should not be derated by age. If actual Distribution Efficiency is not available, use 85% for heat pumps.

System Type	Age of Equipment	HSPF2 Estimate	η_{Heat} (Effective COP Estimate * Distribution Efficiency) (HSPF2/3.413)*0.85
Heat Pump (if age unknown, assume 2006-2014)	Before 2006	5.8	1.44
	After 2006 -2014	6.5	1.62
	2015 on	7	1.74
Resistance	N/A	N/A	1
Unknown (for use in program evaluation only)	N/A	N/A	1.32

¹⁵²³ National Centers for Environmental Information (NCEI) Annual Normals, from 2006 - 2020, calculated with a base temp of 60°F for a conditioned basement and 50°F for an unconditioned basement), consistent with the findings of Belzer and Cort, Pacific Northwest National Laboratory in “Statistical Analysis of Historical State-Level Residential Energy Consumption Trends,” 2004. There is a county mapping table in Volume 1, Section 3.7 providing the appropriate city to use for each county of Illinois.

¹⁵²⁴ Weighted based on number of occupied residential housing units in each zone.

¹⁵²⁵ Justification for degradation factors can be found on page 14 of ‘AIC HVAC Metering Study Memo FINAL 2_28_2018’. Estimate efficiency as (Rated Efficiency * (1-0.01)^Equipment Age).

¹⁵²⁶ These default system efficiencies are based on the applicable minimum Federal Standards. In 2006 the Federal Standard for Heat Pumps was adjusted. While one would expect the average system efficiency to be higher than this minimum, the likely degradation of efficiencies over time means that using the minimum standard is appropriate. An 85% distribution efficiency is then applied to account for duct losses for heat pumps. Note all ratings have been converted to HSPF2 equivalents – since the new rating better reflects the actual efficiency of the units.

ADJ_{BasementHeat} = Adjustment for basement wall insulation to account for prescriptive engineering algorithms overclaiming savings¹⁵²⁷

= 63%

%ElectricHeat = Percent of homes that have electric space heating

= 100 % for Electric Resistance or Heat Pump

= 0 % for Fossil fuel heating

= If unknown¹⁵²⁸, use the following table:

Utility	Location				
	Single Family	Single Family Low Income	Multi Family	Multi Family Low Income	Unknown
Ameren	18%	26%	38%	39%	29%
ComEd	14%	22%	43%	48%	21%
PGL	1.0%	1.5%	4.0%	2.8%	2.2%
NSG	1.3%	0.8%	32.5%	1.2%	3.3%
Nicor	1.3%	0.8%	32.5%	1.2%	3.3%
All DUs ¹⁵²⁹					26%

Note: If a measure is supported by a gas and electric utility through a joint program, and it is unknown whether the participant has a gas supply, the electric utility values in the table above should be used. If it is known that the participant has a gas supply, the values from the gas utility above should be applied.

For example, a single family home in Chicago with a 20 by 25 by 7 foot R-2.25 basement, with 3 feet above grade, insulated with R-13 of interior spray foam, 10.5 SEER Central AC and 2.26 COP Heat Pump:

$$\begin{aligned}
 \Delta kWh &= (\Delta kWh_{cooling} + \Delta kWh_{heating}) \\
 &= [((((1/2.25 - 1/(13 + 2.25)) * (20+25+20+25) * 3 * (1 - 0)) * 24 * 354 * 0.75)/(1000 * 10.5)) * 0.75 * 100\%] + [((((1/2.25 - 1/(13 + 2.25)) * (20+25+20+25) * 3 * (1-0)) + ((1 / (2.25 + 6.42) - 1 / (13 + 2.25 + 6.42)) * (20+25+20+25) * 4 * (1-0))) * 24 * 2845) / (3412 * 1.92)) * 0.63 * 100\%] \\
 &= (46.6 + 835.3) \\
 &= 881.9 kWh
 \end{aligned}$$

$\Delta kWh_{heatingFurnace}$ = If fossil fuel *furnace* heat, kWh savings for reduction in fan run time

¹⁵²⁷ TAC negotiated factor of 60% was originally proposed, then, during update cycle for version v.12, applied the percent change of NCEI Annual Normals HDD60 from 30 yr data set (1981-2010) to more recent 15 yr data (2006-2020) for all cooling-related adjustment values.

¹⁵²⁸ Based on the average % Natural Gas used for space heating in Unknown residential structure types across all utilities covered by the IL program. Residence types include: SF, SF LI, MF & MF LI. Utilities included: Ameren, ComEd, People’s Gas, Northshore Gas & Nicor. Data provided from 2016 Ameren Illinois Demand Side Management (DSM) Market Potential Study by Applied Energy Group, ComEd’s 2019 Baseline Survey on residential space heating share, and PY2022-2023 Implementation Contractors Data for People’s Gas, Northshore Gas & Nicor .

¹⁵²⁹ For the weighted average calculations, please see the Analysis file. PGL, NSG, Nicor & gas customers were assumed to follow the provided split. ComEd total customers, minus overlap with PGL,NSG & Nicor, therefore electric only homes. Ameren is total customers minus Nicor.

$$= \Delta\text{Therms} * F_e * 29.3$$

F_e = Furnace Fan energy consumption as a percentage of annual fuel consumption
 = 3.14%¹⁵³⁰
 29.3 = kWh per therm

For example, a single family home in Chicago with a 20 by 25 by 7 foot unconditioned basement, with 3 feet above grade, insulated with R-13 of interior spray foam, and a 70% efficient furnace (for therm calculation see Fossil Fuel Savings section :

$$= 76.0 * 0.0314 * 29.3$$

$$= 69.9 \text{ kWh}$$

SUMMER COINCIDENT PEAK DEMAND

$$\Delta\text{kW} = (\Delta\text{kWh_cooling} / \text{FLH_cooling}) * \text{CF}$$

Where:

FLH_cooling = Full load hours of air conditioning
 = dependent on location:¹⁵³¹

Climate Zone (City based upon)	Single Family	Multifamily
1 (Rockford)	547	499
2 (Chicago)	709	629
3 (Springfield)	779	707
4 (Belleville)	1082	982
5 (Marion)	956	868
Weighted Average ¹⁵³²		
ComEd	676	603
Ameren	875	791
Statewide	731	655

Use Multifamily if: Building meets utility’s definition for multifamily and HVAC system serves single unit. For residential sized systems serving 2 or more units, assume single family hours.

CF_{SSP} = Summer System Peak Coincidence Factor for Central A/C (during utility peak hour)
 = 68%¹⁵³³

¹⁵³⁰ F_e is not one of the AHRI certified ratings provided for residential furnaces, but can be reasonably estimated from a calculation based on the certified values for fuel energy (E_f in MMBtu/yr) and E_{ae} (kWh/yr). An average of a 300 record sample (non-random) out of 1495 was 3.14%. This is, appropriately, ~50% greater than the ENERGY STAR version 3 criteria for 2% F_e . See “Programmable Thermostats Furnace Fan Analysis.xlsx” for reference.

¹⁵³¹ Full load hours for Chicago, Moline and Rockford are provided in “Final Evaluation Report: Central Air Conditioning Efficiency Services (CACES), 2010, Navigant Consulting”, p.33. An average FLH/Cooling Degree Day (from NCD) ratio was calculated for these locations and applied to the CDD of the other locations in order to estimate FLH. There is a county mapping table in Volume 1, Section 3.7 providing the appropriate city to use for each county of Illinois. During update cycle for version v.12, applied percent change of CDD65, NCEI Annual Normals from 30 yr data set (1981-2010) to more recent 15 yr data (2006-2020) to all FLHcool values.

¹⁵³² Weighting for Ameren is based on electric accounts in each of the cooling zones. Weighting for ComEd and Statewide average is based on number of occupied residential housing units in each zone. ComEd is weighted average of Zones 1-2. Alternative program-weighted assumptions can be used if appropriate.

¹⁵³³ Based on metering of 24 homes with central AC during PY4 and PY5 in Ameren Illinois service territory.

$CF_{SSP, SF}$	= Summer System Peak Coincidence Factor for Heat Pumps in single-family homes (during system peak hour) = 72% ¹⁵³⁴
$CF_{SSP, MF}$	= Summer System Peak Coincidence Factor for Heat Pumps in multi-family homes (during system peak hour) = 67% ¹⁵³⁵
CF_{PJM}	= PJM Summer Peak Coincidence Factor for Central A/C (average during PJM peak period) = 46.6% ¹⁵³⁶
$CF_{PJM, SF}$	= PJM Summer Peak Coincidence Factor for Heat Pumps in single-family homes (average during PJM peak period) = 46.6% ¹⁵³⁷
$CF_{PJM, MF}$	= PJM Summer Peak Coincidence Factor for Heat Pumps in multi-family homes (average during peak period) = 28.5%

For example, a single family home in Chicago with a 20 by 25 by 7 foot unconditioned basement, with 3 feet above grade, insulated with R-13 of interior spray foam, 10.5 SEER Central AC and 2.26 COP Heat Pump:

$$\begin{aligned} \Delta kW_{SSP} &= 46.6 / 709 * 0.68 \\ &= 0.045 \text{ kW} \end{aligned}$$

$$\begin{aligned} \Delta kW_{PJM} &= 46.6 / 709 * 0.466 \\ &= 0.031 \text{ kW} \end{aligned}$$

FOSSIL FUEL SAVINGS

If Fossil Fuel heating:

$$\Delta \text{Therms} = \left(\left(\left(\left(\frac{1}{R_{old_AG}} - \frac{1}{R_{added} + R_{old_AG}} \right) * L_{basement_wall_total} * H_{basement_wall_AG} * (1 - \text{Framing_factor}) \right) + \left(\frac{1}{R_{old_BG}} - \frac{1}{R_{added} + R_{old_BG}} \right) * L_{basement_wall_total} * (H_{basement_wall_total} - H_{basement_wall_AG}) * (1 - \text{Framing_factor}) \right) \right) * 24 * \text{HDD} / (\eta_{Heat} * 100,000) * \text{ADJ}_{BasementHeat} * \%FossilHeat$$

η_{Heat} = Efficiency of heating system
 = Equipment efficiency * distribution efficiency
 = Actual (where it is possible to measure or reasonably estimate). Note where new HVAC is installed in addition to shell measures, the old HVAC unit efficiency should be used and the shell measure savings calculated first, the HVAC measure then assuming the reduced heat/cooling loads. If using rated efficiencies, derate efficiency value by 1% per year

¹⁵³⁴ Based on analysis of metering results from 24 heat pumps in Ameren Illinois service territory in PY5 coincident with AIC's 2010 system peak; 'Impact and Process Evaluation of Ameren Illinois Company's Residential HVAC Program (PY5)'.

¹⁵³⁵ Multifamily coincidence factors both from; *All-Electric Homes PY6 Metering Results: Multifamily HVAC Systems*, Cadmus, October 2015

¹⁵³⁶ Based on analysis of Itron eShape data for Missouri, calibrated to Illinois loads, supplied by Ameren. The average AC load over the PJM peak period (1-5pm, M-F, June through August) is divided by the maximum AC load during the year.

¹⁵³⁷ Based on analysis of Itron eShape data for Missouri, calibrated to Illinois loads, supplied by Ameren. The average AC load over the PJM peak period (1-5pm, M-F, June through August) is divided by the maximum AC load during the year.

(maximum of 30 years) to account for degradation over time,¹⁵³⁸ or if unknown assume 72% for existing system efficiency¹⁵³⁹. If unknown value is used, it should not be derated by age. If actual Distribution Efficiency is not available, use 85%.

- %FossilHeat = Percent of homes that have fossil fuel space heating
- = 100 % for Fossil Fuel heating
- = 0 % for Electric Resistance or Heat Pump
- = If unknown¹⁵⁴⁰, use the following table:

Utility	Location				
	Single Family	Single Family Low Income	Multi Family	Multi Family Low Income	Unknown
Ameren	82%	74%	62%	61%	71%
ComEd	86%	78%	57%	52%	79%
PGL	98.9%	98.5%	96.0%	96.9%	97.7%
NSG	98.3%	99.2%	67.5%	98.8%	96.6%
Nicor	98.3%	99.2%	67.5%	98.8%	96.6%
All DUs¹⁵⁴¹					74%

Note: If a measure is supported by a gas and electric utility through a joint program, and it is unknown whether the participant has a gas supply, the electric utility values in the table above should be used. If it is known that the participant has a gas supply, the values from the gas utility above should be applied.

Other factors as defined above

For example, a single family home in Chicago with a 20 by 25 by 7 foot R-2.25 basement, with 3 feet above grade, insulated with R-13 of interior spray foam, and a 72% efficient furnace:

$$= (((((1/2.25 - 1/(13 + 2.25)) * (20+25+20+25) * 3 * (1-0)) + ((1/8.67 - 1/(13 + 8.67)) * (20+25+20+25) * 4 * (1 - 0)))) * 24 * 2845) / (0.72 * 100,000)) * 0.63 * 100\%$$

= 76.0 therms

Mid-Life adjustment

In order to account for the likely replacement of existing heating and cooling equipment during the lifetime of this measure, a mid-life adjustment should be applied. To calculate the adjustment, re-calculate the savings above using the following new baseline system efficiency assumptions:

Efficiency Assumption	System Type	New Baseline Efficiency
ηCool	Central AC	13.4 SEER2
	Heat Pump	14.3 SEER2
ηHeat	Electric Resistance	1.0 COP

¹⁵³⁸ Justification for degradation factors can be found on page 14 of ‘AIC HVAC Metering Study Memo FINAL 2_28_2018’. Estimate efficiency as (Rated Efficiency * (1-0.01)^Equipment Age).

¹⁵³⁹ Based on average Nicor PY4 nameplate efficiencies derated by 15% for distribution losses.

¹⁵⁴⁰ Based on the average % Natural Gas used for space heating in Unknown residential structure types across all utilities covered by the IL program. Residence types include: SF, SF LI, MF & MF LI. Utilities included: Ameren, ComEd, People’s Gas, Northshore Gas & Nicor. Data provided from 2016 Ameren Illinois Demand Side Management (DSM) Market Potential Study by Applied Energy Group, ComEd’s 2019 Baseline Survey on residential space heating share, and PY2022-2023 Implementation Contractors Data for People’s Gas, Northshore Gas & Nicor .

¹⁵⁴¹ For the weighted average calculations, please see the Analysis file. PGL, NSG, Nicor & gas customers were assumed to follow the provided split. ComEd total customers, minus overlap with PGL,NSG & Nicor, therefore gas only homes. Ameren is total customers minus Nicor.

Efficiency Assumption	System Type	New Baseline Efficiency
	Heat Pump (7.5HSPF/3.413)*0.85	1.87 COP
	Gas Furnace 80% AFUE * 0.85	68% AFUE
	Oil Furnace 83% AFUE * 0.85	71% AFUE
	Gas Boiler	84% AFUE
	Oil Boiler	86% AFUE

This reduced annual savings should be applied following the assumed remaining useful life of the existing equipment, estimate to be 10 years or 13 years for boilers.¹⁵⁴² Note if the existing equipment efficiency is greater than the new baseline efficiency listed above, do not apply a mid-life adjustment.

WATER IMPACT DESCRIPTIONS AND CALCULATION

N/A

DEEMED O&M COST ADJUSTMENT CALCULATION

N/A

MEASURE CODE: RS-SHL-BINS-V15-250101

REVIEW DEADLINE: 1/1/2030

¹⁵⁴² This is intentionally longer than the assumption found in the early replacement measures as the application of this measure will occur in a variety of homes and will not be targeting those homes appropriate for early replacement HVAC systems.

5.6.3 Floor Insulation Above Crawlspace

DESCRIPTION

Insulation is added to the floor above a vented crawl space that does not contain pipes or HVAC equipment. If there are pipes, HVAC, or a basement, it is desirable to keep them within the conditioned space by insulating the crawl space walls and ground. Insulating the floor separates the conditioned space above from the space below the floor, and is only acceptable when there is nothing underneath that could freeze or would operate less efficiently in an environment resembling the outdoors. Even in the case of an empty, unvented crawl space, it is still considered best practice to seal and insulate the crawl space perimeter rather than the floor. Not only is there generally less area to insulate this way, but there are also moisture control benefits. There is a “Basement Insulation” measure for perimeter sealing and insulation. This measure assumes the insulation is installed above an unvented crawl space and should not be used in other situations.

This measure was developed to be applicable to the following program types: RF.

If applied to other program types, the measure savings should be verified.

DEFINITION OF EFFICIENT EQUIPMENT

This measure requires a member of the implementation staff or a participating contractor to evaluate the pre and post R-values and measure surface areas. The requirements for participation in the program will be defined by the utilities.

DEFINITION OF BASELINE EQUIPMENT

The existing condition will be evaluated by implementation staff or a participating contractor and is likely to be no insulation on any surface surrounding a crawl space.

DEEMED LIFETIME OF EFFICIENT EQUIPMENT

The expected measure life is assumed to be 30 years.¹⁵⁴³

Note a mid-life adjustment to account for replacement of HVAC equipment during the measure life should be applied after 10 years or 13 years for boilers.¹⁵⁴⁴ See section below for detail.

DEEMED MEASURE COST

The actual installed cost for this measure should be used in screening.

DEEMED O&M COST ADJUSTMENTS

N/A

LOADSHAPE

Loadshape R08 - Residential Cooling

Loadshape R09 - Residential Electric Space Heat

Loadshape R10 - Residential Electric Heating and Cooling

COINCIDENCE FACTOR

The summer peak coincidence factor for cooling is provided in two different ways below. The first is used to estimate peak savings during the utility peak hour and is most indicative of actual peak benefits, and the second represents

¹⁵⁴³ As recommended in Guidehouse ‘EMV Group A, Deliverable 16 EUL Research – Residential Insulation’, prepared for California Public Utilities Commission, June 2021.

¹⁵⁴⁴ This is intentionally longer than the assumptions found in the early replacement measures as the application of this measure will occur in a variety of homes that will not be targeted for early replacement HVAC systems.

the *average* savings over the defined summer peak period, and is presented so that savings can be bid into PJM’s capacity market.

CF _{SSP}	= Summer System Peak Coincidence Factor for Central A/C (during utility peak hour) = 68% ¹⁵⁴⁵
CF _{SSP SF}	= Summer System Peak Coincidence Factor for Heat Pumps in single family homes (during system peak hour) = 72% ¹⁵⁴⁶
CF _{SSP, MF}	= Summer System Peak Coincidence Factor for Heat Pumps in multifamily homes (during system peak hour) = 67% ¹⁵⁴⁷
CF _{PJM}	= PJM Summer Peak Coincidence Factor for Central A/C (average during PJM peak period) = 46.6% ¹⁵⁴⁸
CF _{PJM SF}	= PJM Summer Peak Coincidence Factor for Heat Pumps in single family homes (average during PJM peak period) = 46.6% ¹⁵⁴⁹
CF _{PJM, MF}	= PJM Summer Peak Coincidence Factor for Heat Pumps in multifamily homes (average during peak period) = 28.5%

Algorithm

CALCULATION OF SAVINGS

ELECTRIC ENERGY SAVINGS

Where available savings from shell insulation measures should be determined through a custom analysis. When that is not feasible for the program the following engineering algorithms can be used with the inclusion of an adjustment factor to de-rate the heating savings.

$$\Delta kWh = (\Delta kWh_{cooling} + \Delta kWh_{heatingElectric} + \Delta kWh_{heatingFurnace})$$

Where:

ΔkWh _{cooling}	= If central cooling, reduction in annual cooling requirement due to insulation = (((1/R _{old} - 1/(R _{added} +R _{old})) * Area * (1-Framing _{factor})) * 24 * CDD * DUA) / (1000 * η _{Cool})) * ADJ _{FloorCool} * %Cool
R _{old}	= R-value value of floor before insulation, assuming 3/4” plywood subfloor and carpet with pad

¹⁵⁴⁵ Based on metering of 24 homes with central AC during PY4 and PY5 in Ameren Illinois service territory.

¹⁵⁴⁶ Based on analysis of metering results from 24 heat pumps in Ameren Illinois service territory in PY5 coincident with AIC’s 2010 system peak; ‘Impact and Process Evaluation of Ameren Illinois Company’s Residential HVAC Program (PY5)’.

¹⁵⁴⁷ Multifamily coincidence factors both from; *All-Electric Homes PY6 Metering Results: Multifamily HVAC Systems*, Cadmus, October 2015

¹⁵⁴⁸ Based on analysis of Itron eShape data for Missouri, calibrated to Illinois loads, supplied by Ameren. The average AC load over the PJM peak period (1-5pm, M-F, June through August) is divided by the maximum AC load during the year.

¹⁵⁴⁹ Based on analysis of Itron eShape data for Missouri, calibrated to Illinois loads, supplied by Ameren. The average AC load over the PJM peak period (1-5pm, M-F, June through August) is divided by the maximum AC load during the year.

- = Actual. If unknown assume 3.53 ¹⁵⁵⁰
- R_{added} = R-value of additional spray foam, rigid foam, or cavity insulation.
- Area = Total floor area to be insulated
- Framing_factor = Adjustment to account for area of framing
= 12% ¹⁵⁵¹
- 24 = Converts hours to days
- CDD = Cooling Degree Days

Climate Zone (City based upon)	Unconditioned CDD75 ¹⁵⁵²
1 (Rockford)	326
2 (Chicago)	354
3 (Springfield)	448
4 (Belleville)	532
5 (Marion)	516
Weighted Average ¹⁵⁵³	380

- DUA = Discretionary Use Adjustment (reflects the fact that people do not always operate their AC when conditions may call for it).
= 0.75 ¹⁵⁵⁴
- 1000 = Converts Btu to kBtu
- ηCool = Seasonal Energy Efficiency Ratio of cooling system (kBtu/kWh)
= Actual (where it is possible to measure or reasonably estimate). Note where new HVAC is installed in addition to shell measures, the old HVAC unit efficiency should be used and the shell measure savings calculated first, the HVAC measure then assuming the reduced heat/cooling loads. If using rated efficiencies, derate efficiency value by 1% per year (maximum of 30 years) to account for degradation over time,¹⁵⁵⁵ or if unknown assume the following.¹⁵⁵⁶ If unknown value is used, it should not be derated by age.

Age of Equipment	ηCool Estimate
Before 2006	9.5
2006 - 2014	12.4
Central AC After 1/1/2015	12.4

¹⁵⁵⁰ Based on 2005 ASHRAE Handbook – Fundamentals: assuming ¾” subfloor, ½” carpet with rubber pad, and accounting for a still air film above and below: 0.68 + 0.94 + 1.23 + 0.68 = 3.53

¹⁵⁵¹ ASHRAE, 2001, “Characterization of Framing Factors for New Low-Rise Residential Building Envelopes (904-RP),” Table 7.1

¹⁵⁵² Five year average (2018 to 2022) cooling degree days with a base temperature of 75 F. Data from DegreeDays.net were used in this table because the climate normals from NCEI/NCDC used elsewhere are not available at base temps above 72F.

¹⁵⁵³ Weighted based on number of occupied residential housing units in each zone (US Census 2010).

¹⁵⁵⁴ Energy Center of Wisconsin, May 2008 metering study; “Central Air Conditioning in Wisconsin, A Compilation of Recent Field Research”, p31.

¹⁵⁵⁵ Justification for degradation factors can be found on page 14 of ‘A/C HVAC Metering Study Memo FINAL 2_28_2018’. Estimate efficiency as (Rated Efficiency * (1-0.01)^Equipment Age).

¹⁵⁵⁶ These default system efficiencies are based on the applicable minimum Federal Standards. In 2006 the Federal Standard for Central AC was adjusted. While one would expect the average system efficiency to be higher than this minimum, the likely degradation of efficiencies over time means that using the minimum standard is appropriate. Note all ratings have been converted to SEER2 equivalents – since the new rating better reflects the actual efficiency of the units.

Heat Pump After 1/1/2015	13.3
Unknown (for use in program evaluation only)	10.0

ADJ_{FloorCool} = Adjustment for cooling savings from floor to account for prescriptive engineering algorithms overclaiming savings¹⁵⁵⁷
 = 75%

%Cool = Percent of homes that have cooling

Central Cooling?	%Cool
Yes	100%
No	0%
Unknown (for use in program evaluation only) ¹⁵⁵⁸	66%

ΔkWh_{heatingElectric} = If electric heat (resistance or heat pump), reduction in annual electric heating due to insulation

$$= ((1/R_{old} - 1/(R_{added} + R_{old})) * Area * (1-Framing_factor) * 24 * HDD) / (3,412 * \eta_{Heat}) * ADJ_{FloorHeat} * \%ElectricHeat$$

HDD = Heating Degree Days:¹⁵⁵⁹

Climate Zone (City based upon)	Unconditioned HDD
1 (Rockford)	3233
2 (Chicago)	2845
3 (Springfield)	2456
4 (Belleville)	1651
5 (Marion/Murphysboro)	1750
Weighted Average ¹⁵⁶⁰	2732

ηHeat = Efficiency of heating system

= Actual Heating Efficiency * Distribution Efficiency (where it is possible to measure or reasonably estimate). Note where new HVAC is installed in addition to shell measures, the old HVAC unit efficiency should be used and the shell measure savings calculated first, the HVAC measure then assuming the reduced heat/cooling loads. If using rated efficiencies, derate efficiency value by 1% per year (maximum of 30 years) to account for

¹⁵⁵⁷ As demonstrated in two years of metering evaluation by Opinion Dynamics, see Memo “Results for AIC PY6 HPwES Billing Analysis”, dated February 20, 2015. TAC negotiated adjustment factor is 80%. During update cycle for version v.12, applied the percent change of NCEI Annual Normals CDD65 from 30 yr data set (1981-2010) to more recent 15 yr data (2006-2020) for all cooling-related adjustment values.

¹⁵⁵⁸ Percentage of homes in Illinois that have central cooling from “Table HC7.9 Air Conditioning in Homes in Midwest Region, Divisions, and States, 2009” from Energy Information Administration, 2009 Residential Energy Consumption Survey

¹⁵⁵⁹ National Centers for Environmental Information (NCEI) Annual Normals, from 2006 - 2020, calculated with a base temp of 50°F to account for lower impact of unconditioned space on heating system. There is a county mapping table in Volume 1, Section 3.7 providing the appropriate city to use for each county of Illinois.

¹⁵⁶⁰ Weighted based on number of occupied residential housing units in each zone.

degradation over time,¹⁵⁶¹ or if not available refer to default table below.¹⁵⁶² If unknown value is used, it should not be derated by age. If actual Distribution Efficiency is not available, use 85%.

System Type	Age of Equipment	HSPF2 Estimate	η_{Heat} (Effective COP Estimate * Distribution Efficiency) $(\text{HSPF2}/3.413)*0.85$
Heat Pump (if age unknown, assume 2006-2014)	Before 2006	5.8	1.44
	After 2006 -2014	6.5	1.62
	2015 on	7	1.74
Resistance	N/A	N/A	1
Unknown (for use in program evaluation only)	N/A	N/A	1.32

$ADJ_{\text{FloorHeat}}$ = Adjustment for floor insulation to account for prescriptive engineering algorithms overclaiming savings¹⁵⁶³
 = 63%

$\%ElectricHeat$ = Percent of homes that have electric space heating
 = 100 % for Electric Resistance or Heat Pump
 = 0 % for Fossil Fuel heating
 = If unknown¹⁵⁶⁴, use the following table:

Utility	Location				
	Single Family	Single Family Low Income	Multi Family	Multi Family Low Income	Unknown
Ameren	18%	26%	38%	39%	29%
ComEd	14%	22%	43%	48%	21%
PGL	1.0%	1.5%	4.0%	2.8%	2.2%
NSG	1.3%	0.8%	32.5%	1.2%	3.3%
Nicor	1.3%	0.8%	32.5%	1.2%	3.3%

¹⁵⁶¹ Justification for degradation factors can be found on page 14 of ‘AIC HVAC Metering Study Memo FINAL 2_28_2018’. Estimate efficiency as $(\text{Rated Efficiency} * (1-0.01)^{\text{Equipment Age}})$.

¹⁵⁶² These default system efficiencies are based on the applicable minimum Federal Standards. In 2006 the Federal Standard for Heat Pumps was adjusted. While one would expect the average system efficiency to be higher than this minimum, the likely degradation of efficiencies over time means that using the minimum standard is appropriate. An 85% distribution efficiency is then applied to account for duct losses for heat pumps. Note all ratings have been converted to HSPF2 equivalents – since the new rating better reflects the actual efficiency of the units.

¹⁵⁶³ As demonstrated in two years of metering evaluation by Opinion Dynamics, see Memo “Results for AIC PY6 HPwES Billing Analysis”, dated February 20, 2015. TAC negotiated adjustment factor is 60%. During update cycle for version v.12, applied the percent change of NCEI Annual Normals HDD60 from 30 yr data set (1981-2010) to more recent 15 yr data (2006-2020) for all heating-related adjustment values.

¹⁵⁶⁴ Based on the average % Natural Gas used for space heating in Unknown residential structure types across all utilities covered by the IL program. Residence types include: SF, SF LI, MF & MF LI. Utilities included: Ameren, ComEd, People’s Gas, Northshore Gas & Nicor. Data provided from 2016 Ameren Illinois Demand Side Management (DSM) Market Potential Study by Applied Energy Group, ComEd’s 2019 Baseline Survey on residential space heating share, and PY2022-2023 Implementation Contractors Data for People’s Gas, Northshore Gas & Nicor .

Utility	Location				
	Single Family	Single Family Low Income	Multi Family	Multi Family Low Income	Unknown
All DUs ¹⁵⁶⁵					26%

Note: If a measure is supported by a gas and electric utility through a joint program, and it is unknown whether the participant has a gas supply, the electric utility values in the table above should be used. If it is known that the participant has a gas supply, the values from the gas utility above should be applied.

Other factors as defined above.

For example, a single family home in Chicago with a 20 by 25 footprint, insulated with R-30 spray foam above the crawlspace, a 10.5 SEER Central AC and a newer heat pump:

$$\begin{aligned} \Delta kWh &= (\Delta kWh_{cooling} + \Delta kWh_{heating}) \\ &= (((1/3.53 - 1/(30+3.53)) * (20*25) * (1-0.12) * 24 * 354 * 0.75) / (1000 * 10.5)) * 0.75 * 1 + \\ &\quad (((1/3.53 - 1/(30+3.53)) * (20*25) * (1-0.15) * 24 * 2845) / (3412 * 1.92)) * 0.63 * 1) \\ &= (50.8 + 707.3) \\ &= 758.1 kWh \end{aligned}$$

$\Delta kWh_{heatingFurnace}$ = If fossil fuel *furnace* heat, kWh savings for reduction in fan run time

$$= \Delta Therms * F_e * 29.3$$

F_e = Furnace Fan energy consumption as a percentage of annual fuel consumption

$$= 3.14\%^{1566}$$

29.3 = kWh per therm

For example, a single family home in Chicago with a 20 by 25 footprint, insulated with R-30 spray foam above the crawlspace, and a 70% efficient furnace (for therm calculation see Fossil Fuel Savings section):

$$\begin{aligned} \Delta kWh &= 66.6 * 0.0314 * 29.3 \\ &= 61.3 kWh \end{aligned}$$

SUMMER COINCIDENT PEAK DEMAND SAVINGS

$$\Delta kW = (\Delta kWh_{cooling} / FLH_{cooling}) * CF$$

Where:

$FLH_{cooling}$ = Full load hours of air conditioning

= Dependent on location:¹⁵⁶⁷

¹⁵⁶⁵ For the weighted average calculations, please see the Analysis file. PGL, NSG, Nicor & gas customers were assumed to follow the provided split. ComEd total customers, minus overlap with PGL, NSG & Nicor, therefore electric only homes. Ameren is total customers minus Nicor.

¹⁵⁶⁶ F_e is not one of the AHRI certified ratings provided for residential furnaces, but can be reasonably estimated from a calculation based on the certified values for fuel energy (E_f in MMBtu/yr) and E_{ae} (kWh/yr). An average of a 300 record sample (non-random) out of 1495 was 3.14%. This is, appropriately, ~50% greater than the ENERGY STAR version 3 criteria for 2% F_e . See "Programmable Thermostats Furnace Fan Analysis.xlsx" for reference.

¹⁵⁶⁷ Full load hours for Chicago, Moline and Rockford are provided in "Final Evaluation Report: Central Air Conditioning Efficiency Services (CACES), 2010, Navigant Consulting", p.33. An average FLH/Cooling Degree Day (from NCDC) ratio was calculated for these locations and applied to the CDD of the other locations in order to estimate FLH. There is a county mapping

Climate Zone (City based upon)	Single Family	Multifamily
1 (Rockford)	547	499
2 (Chicago)	709	629
3 (Springfield)	779	707
4 (Belleville)	1082	982
5 (Marion)	956	868
Weighted Average ¹⁵⁶⁸		
ComEd	676	603
Ameren	875	791
Statewide	731	655

Use Multifamily if: Building meets utility’s definition for multifamily and HVAC system serves single unit. For residential sized systems serving 2 or more units, assume single family hours.

CF_{SSP} = Summer System Peak Coincidence Factor for Central A/C (during utility peak hour)
= 68%¹⁵⁶⁹

CF_{SSP SF} = Summer System Peak Coincidence Factor for Heat Pumps in single family homes (during system peak hour)
= 72%¹⁵⁷⁰

CF_{SSP, MF} = Summer System Peak Coincidence Factor for Heat Pumps in multifamily homes (during system peak hour)
= 67%¹⁵⁷¹

CF_{PJM} = PJM Summer Peak Coincidence Factor for Central A/C (average during PJM peak period)
= 46.6%¹⁵⁷²

CF_{PJM SF} = PJM Summer Peak Coincidence Factor for Heat Pumps in single family homes (average during PJM peak period)
= 46.6%¹⁵⁷³

CF_{PJM, MF} = PJM Summer Peak Coincidence Factor for Heat Pumps in multifamily homes (average during peak period)
= 28.5%

table in Volume 1, Section 3.7 providing the appropriate city to use for each county of Illinois. During update cycle for version v.12, applied percent change of CDD65, NCEI Annual Normals from 30 yr data set (1981-2010) to more recent 15 yr data (2006-2020) to all FLHcool values.

¹⁵⁶⁸ Weighting for Ameren is based on electric accounts in each of the cooling zones. Weighting for ComEd and Statewide average is based on number of occupied residential housing units in each zone. ComEd is weighted average of Zones 1-2. Alternative program-weighted assumptions can be used if appropriate.

¹⁵⁶⁹ Based on metering of 24 homes with central AC during PY4 and PY5 in Ameren Illinois service territory.

¹⁵⁷⁰ Based on analysis of metering results from 24 heat pumps in Ameren Illinois service territory in PY5 coincident with AIC’s 2010 system peak; ‘Impact and Process Evaluation of Ameren Illinois Company’s Residential HVAC Program (PY5)’.

¹⁵⁷¹ Multifamily coincidence factors both from; *All-Electric Homes PY6 Metering Results: Multifamily HVAC Systems*, Cadmus, October 2015

¹⁵⁷² Based on analysis of Itron eShape data for Missouri, calibrated to Illinois loads, supplied by Ameren. The average AC load over the PJM peak period (1-5pm, M-F, June through August) is divided by the maximum AC load during the year.

¹⁵⁷³ Based on analysis of Itron eShape data for Missouri, calibrated to Illinois loads, supplied by Ameren. The average AC load over the PJM peak period (1-5pm, M-F, June through August) is divided by the maximum AC load during the year.

For example, a single family home in Chicago with a 20 by 25 footprint, insulated with R-30 spray foam above the crawlspace, a 10.5 SEER Central AC and a newer heat pump:

$$\begin{aligned} \Delta kW_{SSP} &= 50.8 / 709 * 0.68 \\ &= 0.05 \text{ kW} \end{aligned}$$

$$\begin{aligned} \Delta kW_{SSP} &= 50.8 / 709 * 0.466 \\ &= 0.033 \text{ kW} \end{aligned}$$

FOSSIL FUEL SAVINGS

If Fossil Fuel heating:

$$\Delta \text{Therms} = \left(\left(\frac{1}{R_{\text{old}}} - \frac{1}{R_{\text{added}} + R_{\text{old}}} \right) * \text{Area} * (1 - \text{Framing_factor}) * 24 * \text{HDD} \right) / \left(100,000 * \eta_{\text{Heat}} \right) * \text{ADJ}_{\text{FloorHeat}} * \% \text{FossilHeat}$$

Where:

η_{Heat} = Efficiency of heating system
 = Equipment efficiency * distribution efficiency
 = Actual (where it is possible to measure or reasonably estimate). Note where new HVAC is installed in addition to shell measures, the old HVAC unit efficiency should be used and the shell measure savings calculated first, the HVAC measure then assuming the reduced heat/cooling loads. If using rated efficiencies, derate efficiency value by 1% per year (maximum of 30 years) to account for degradation over time,¹⁵⁷⁴ or if unknown assume 72% for existing system efficiency.¹⁵⁷⁵ If unknown value is used, it should not be derated by age. If actual Distribution Efficiency is not available, use 85%.

$\% \text{FossilHeat}$ = Percent of homes that have fossil fuel space heating
 = 100 % for Fossil Fuel heating
 = 0 % for Electric Resistance or Heat Pump
 = If unknown¹⁵⁷⁶, use the following table:

Utility	Location				
	Single Family	Single Family Low Income	Multi Family	Multi Family Low Income	Unknown
Ameren	82%	74%	62%	61%	71%
ComEd	86%	78%	57%	52%	79%
PGL	98.9%	98.5%	96.0%	96.9%	97.7%
NSG	98.3%	99.2%	67.5%	98.8%	96.6%
Nicor	98.3%	99.2%	67.5%	98.8%	96.6%
All DUs¹⁵⁷⁷					74%

¹⁵⁷⁴ Justification for degradation factors can be found on page 14 of ‘AIC HVAC Metering Study Memo FINAL 2_28_2018’. Estimate efficiency as (Rated Efficiency * (1-0.01)^Equipment Age).

¹⁵⁷⁵ Based on average Nicor PY4 nameplate efficiencies derated by 15% for distribution losses.

¹⁵⁷⁶ Based on the average % Natural Gas used for space heating in Unknown residential structure types across all utilities covered by the IL program. Residence types include: SF, SF LI, MF & MF LI. Utilities included: Ameren, ComEd, People’s Gas, Northshore Gas & Nicor. Data provided from 2016 Ameren Illinois Demand Side Management (DSM) Market Potential Study by Applied Energy Group, ComEd’s 2019 Baseline Survey on residential space heating share, and PY2022-2023 Implementation Contractors Data for People’s Gas, Northshore Gas & Nicor .

¹⁵⁷⁷ For the weighted average calculations, please see the Analysis file. PGL, NSG, Nicor & gas customers were assumed to follow the provided split. ComEd total customers, minus overlap with PGL,NSG & Nicor, therefore gas only homes. Ameren is total customers minus Nicor.

Note: If a measure is supported by a gas and electric utility through a joint program, and it is unknown whether the participant has a gas supply, the electric utility values in the table above should be used. If it is known that the participant has a gas supply, the values from the gas utility above should be applied.

Other factors as defined above.

For example, a single family home in Chicago with a 20 by 25 footprint, insulated with R-30 spray foam above the crawlspace, and a 72% efficient furnace:

$$\Delta\text{Therms} = ((1 / 3.53 - 1 / (30 + 3.53)) * (20 * 25) * (1 - 0.12) * 24 * 2845) / (100,000 * 0.72) * 0.63 * 1$$

$$= 66.6 \text{ therms}$$

Mid-Life adjustment

In order to account for the likely replacement of existing heating and cooling equipment during the lifetime of this measure, a mid-life adjustment should be applied. To calculate the adjustment, re-calculate the savings above using the following new baseline system efficiency assumptions:

Efficiency Assumption	System Type	New Baseline Efficiency
ηCool	Central AC	13.4 SEER2
	Heat Pump	14.3 SEER2
ηHeat	Electric Resistance	1.0 COP
	Heat Pump (7.5HSPF/3.413)*0.85	1.87 COP
	Gas Furnace 80% AFUE * 0.85	68% AFUE
	Oil Furnace 83% AFUE * 0.85	71% AFUE
	Gas Boiler	84% AFUE
	Oil Boiler	86% AFUE

This reduced annual savings should be applied following the assumed remaining useful life of the existing equipment, estimate to be 10 years or 13 years for boilers.¹⁵⁷⁸ Note if the existing equipment efficiency is greater than the new baseline efficiency listed above, do not apply a mid-life adjustment.

WATER IMPACT DESCRIPTIONS AND CALCULATION

N/A

DEEMED O&M COST ADJUSTMENT CALCULATION

N/A

¹⁵⁷⁸ This is intentionally longer than the assumption found in the early replacement measures as the application of this measure will occur in a variety of homes and will not be targeting those homes appropriate for early replacement HVAC systems.

MEASURE CODE: RS-SHL-FINS-V16-250101

REVIEW DEADLINE: 1/1/2030

5.6.4 Wall Insulation

DESCRIPTION

Insulation is added to wall cavities. This measure requires a member of the implementation staff evaluating the pre and post R-values and measure surface areas. The efficiency of the heating and cooling equipment in the home should also be evaluated if possible.

This measure was developed to be applicable to the following program types: RF.

If applied to other program types, the measure savings should be verified.

DEFINITION OF EFFICIENT EQUIPMENT

This measure requires a member of the implementation staff or a participating contractor to evaluate the pre and post R-values and measure surface areas. The requirements for participation in the program will be defined by the utilities.

DEFINITION OF BASELINE EQUIPMENT

The existing condition will be evaluated by implementation staff or a participating contractor and is likely to be empty wall cavities.

DEEMED LIFETIME OF EFFICIENT EQUIPMENT

The expected measure life is assumed to be 30 years.¹⁵⁷⁹

Note a mid-life adjustment to account for replacement of HVAC equipment during the measure life should be applied after 10 years or 13 years for boilers.¹⁵⁸⁰ See section below for detail.

DEEMED MEASURE COST

The actual installed cost for this measure should be used in screening.

LOADSHAPE

Loadshape R08 - Residential Cooling

Loadshape R09 - Residential Electric Space Heat

Loadshape R10 - Residential Electric Heating and Cooling

COINCIDENCE FACTOR

The summer peak coincidence factor for cooling is provided in two different ways below. The first is used to estimate peak savings during the utility peak hour and is most indicative of actual peak benefits, and the second represents the *average* savings over the defined summer peak period, and is presented so that savings can be bid into PJM's capacity market.

CF_{SSP} = Summer System Peak Coincidence Factor for Central A/C (during utility peak hour)
= 68%¹⁵⁸¹

$CF_{SSP SF}$ = Summer System Peak Coincidence Factor for Heat Pumps in single family homes (during system peak hour)

¹⁵⁷⁹ As recommended in Guidehouse 'EMV Group A, Deliverable 16 EUL Research – Residential Insulation', prepared for California Public Utilities Commission, June 2021.

¹⁵⁸⁰ This is intentionally longer than the assumptions found in the early replacement measures as the application of this measure will occur in a variety of homes that will not be targeted for early replacement HVAC systems.

¹⁵⁸¹ Based on metering of 24 homes with central AC during PY4 and PY5 in Ameren Illinois service territory.

	= 72% ¹⁵⁸²
CF _{SSP, MF}	= Summer System Peak Coincidence Factor for Heat Pumps in multifamily homes (during system peak hour) = 67% ¹⁵⁸³
CF _{PJM}	= PJM Summer Peak Coincidence Factor for Central A/C (average during PJM peak period) = 46.6% ¹⁵⁸⁴
CF _{PJM SF}	= PJM Summer Peak Coincidence Factor for Heat Pumps in single family homes (average during PJM peak period) = 46.6% ¹⁵⁸⁵
CF _{PJM, MF}	= PJM Summer Peak Coincidence Factor for Heat Pumps in multifamily homes (average during peak period) = 28.5%

Algorithm

CALCULATION OF SAVINGS

ELECTRIC ENERGY SAVINGS

Where available savings from shell insulation measures should be determined through a custom analysis. When that is not feasible for the program the following engineering algorithms can be used with the inclusion of an adjustment factor to de-rate the heating savings.

$$\Delta kWh = \Delta kWh_{cooling} + \Delta kWh_{heatingElectric} + \Delta kWh_{heatingFurnace}$$

Where

- $\Delta kWh_{cooling}$ = If central cooling, reduction in annual cooling requirement due to wall insulation
= $\left(\left(\left(\frac{1}{R_{old}} - \frac{1}{R_{wall}} \right) * A_{wall} * (1 - Framing_factor_wall) \right) * 24 * CDD * DUA \right) / (1000 * \eta_{Cool}) * ADJ_{WallCool} * \%Cool$
- R_{wall} = R-value of new wall assembly (including all layers between inside air and outside air).
- R_{old} = R-value value of existing assembly and any existing insulation.
(Minimum of R-5 for uninsulated assemblies)¹⁵⁸⁶
- A_{wall} = Net area of insulated wall (ft²)
- Framing_factor_wall = Adjustment to account for area of framing

¹⁵⁸² Based on analysis of metering results from 24 heat pumps in Ameren Illinois service territory in PY5 coincident with AIC's 2010 system peak; 'Impact and Process Evaluation of Ameren Illinois Company's Residential HVAC Program (PY5)'.

¹⁵⁸³ Multifamily coincidence factors both from; *All-Electric Homes PY6 Metering Results: Multifamily HVAC Systems*, Cadmus, October 2015

¹⁵⁸⁴ Based on analysis of Itron eShape data for Missouri, calibrated to Illinois loads, supplied by Ameren. The average AC load over the PJM peak period (1-5pm, M-F, June through August) is divided by the maximum AC load during the year.

¹⁵⁸⁵ Based on analysis of Itron eShape data for Missouri, calibrated to Illinois loads, supplied by Ameren. The average AC load over the PJM peak period (1-5pm, M-F, June through August) is divided by the maximum AC load during the year.

¹⁵⁸⁶ An estimate based on review of Madison Gas and Electric, Exterior Wall Insulation, R-value for no insulation in walls, and NREL's Building Energy Simulation Test for Existing Homes (BESTEST-EX).

- = 25%¹⁵⁸⁷
- 24 = Converts hours to days
- CDD = Cooling Degree Days
- = dependent on location:¹⁵⁸⁸

Climate Zone (City based upon)	CDD 65
1 (Rockford)	877
2 (Chicago)	1047
3 (Springfield)	1183
4 (Belleville)	1641
5 (Marion)	1450
Weighted Average ¹⁵⁸⁹	1098

DUA = Discretionary Use Adjustment (reflects the fact that people do not always operate their AC when conditions may call for it).

= 0.75 ¹⁵⁹⁰

1000 = Converts Btu to kBtu

η_{Cool} = Seasonal Energy Efficiency Ratio of cooling system (kBtu/kWh)

= Actual (where it is possible to measure or reasonably estimate). Note where new HVAC is installed in addition to shell measures, the old HVAC unit efficiency should be used and the shell measure savings calculated first, the HVAC measure then assuming the reduced heat/cooling loads. If using rated efficiencies, derate efficiency value by 1% per year (maximum of 30 years) to account for degradation over time,¹⁵⁹¹ or if unknown assume the following.¹⁵⁹² If unknown value is used, it should not be derated by age.

Age of Equipment	η_{Cool} Estimate
Before 2006	9.5
2006 - 2014	12.4
Central AC After 1/1/2015	12.4
Heat Pump After 1/1/2015	13.3
Unknown (for use in program evaluation only)	10.0

¹⁵⁸⁷ ASHRAE, 2001, "Characterization of Framing Factors for New Low-Rise Residential Building Envelopes (904-RP)," Table 7.1

¹⁵⁸⁸ National Centers for Environmental Information (NCEI) Annual Normals, from 2006 - 2020, calculated with a base temp of 65°F. There is a county mapping table Volume 1, Section 3.7 providing the appropriate city to use for each county of Illinois.

¹⁵⁸⁹ Weighted based on number of occupied residential housing units in each zone (US Census 2010).

¹⁵⁹⁰ This factor's source is: Energy Center of Wisconsin, May 2008 metering study; "Central Air Conditioning in Wisconsin, A Compilation of Recent Field Research", p31.

¹⁵⁹¹ Justification for degradation factors can be found on page 14 of 'AIC HVAC Metering Study Memo FINAL 2_28_2018'. Estimate efficiency as (Rated Efficiency * (1-0.01)^Equipment Age).

¹⁵⁹² These default system efficiencies are based on the applicable minimum Federal Standards. In 2006 the Federal Standard for Central AC was adjusted. While one would expect the average system efficiency to be higher than this minimum, the likely degradation of efficiencies over time means that using the minimum standard is appropriate. Note all ratings have been converted to SEER2 equivalents – since the new rating better reflects the actual efficiency of the units. Note all ratings have been converted to SEER2 equivalents – since the new rating better reflects the actual efficiency of the units.

ADJ_{WallCool} = Adjustment for cooling savings from wall insulation to account for inaccuracies in prescriptive engineering algorithms¹⁵⁹³
 = 75%

%Cool = Percent of homes that have cooling

Central Cooling?	%Cool
Yes	100%
No	0%
Unknown (for use in program evaluation only) ¹⁵⁹⁴	66%

kWh_{heatingElectric} = If electric heat (resistance or heat pump), reduction in annual electric heating due to wall insulation

$$= ((1/R_{old} - 1/R_{wall}) * A_{wall} * (1-Framing_factor_{wall}) * 24 * HDD) / (\eta_{Heat} * 3412) * ADJ_{WallHeat} * \%ElectricHeat$$

HDD = Heating Degree Days

= Dependent on location:¹⁵⁹⁵

Climate Zone (City based upon)	HDD 60
1 (Rockford)	5230
2 (Chicago)	4798
3 (Springfield)	4266
4 (Belleville)	3188
5 (Marion)	3390
Weighted Average ¹⁵⁹⁶	4631

ηHeat = Efficiency of heating system

= Actual Heating Efficiency * Distribution Efficiency (where it is possible to measure or reasonably estimate). Note where new HVAC is installed in addition to shell measures, the old HVAC unit efficiency should be used and the shell measure savings calculated first, the HVAC measure then assuming the reduced heat/cooling loads. If using rated efficiencies, derate efficiency value by 1% per year (maximum of 30 years) to account for degradation over time,¹⁵⁹⁷ or if not available refer to default table below.¹⁵⁹⁸ If unknown

¹⁵⁹³ As demonstrated in two years of metering evaluation by Opinion Dynamics, see Memo “Results for AIC PY6 HPwES Billing Analysis”, dated February 20, 2015. TAC negotiated adjustment factor is 80%. During update cycle for version v.12, applied the percent change of NCEI Annual Normals CDD65 from 30 yr data set (1981-2010) to more recent 15 yr data (2006-2020) for all cooling-related adjustment values.

¹⁵⁹⁴ Percentage of homes in Illinois that have central cooling from “Table HC7.9 Air Conditioning in Homes in Midwest Region, Divisions, and States, 2009” from Energy Information Administration, 2009 Residential Energy Consumption Survey

¹⁵⁹⁵ National Centers for Environmental Information (NCEI) Annual Normals, from 2006 - 2020, calculated with a base temp of 60°F, consistent with the findings of Belzer and Cort, Pacific Northwest National Laboratory in “Statistical Analysis of Historical State-Level Residential Energy Consumption Trends,” 2004. There is a county mapping table in Volume 1, Section 3.7 providing the appropriate city to use for each county of Illinois.

¹⁵⁹⁶ Weighted based on number of occupied residential housing units in each zone.

¹⁵⁹⁷ Justification for degradation factors can be found on page 14 of ‘AIC HVAC Metering Study Memo FINAL 2_28_2018’. Estimate efficiency as (Rated Efficiency * (1-0.01)^Equipment Age).

¹⁵⁹⁸ These default system efficiencies are based on the applicable minimum Federal Standards. In 2006 the Federal Standard for

value is used, it should not be derated by age. If actual Distribution Efficiency is not available, use 85% for heat pumps.

System Type	Age of Equipment	HSPF2 Estimate	η_{Heat} (Effective COP Estimate * Distribution Efficiency) $(\text{HSPF2}/3.413)*0.85$
Heat Pump (if age unknown, assume 2006-2014)	Before 2006	5.8	1.44
	After 2006 -2014	6.5	1.62
	2015 on	7	1.74
Resistance	N/A	N/A	1
Unknown (for use in program evaluation only)	N/A	N/A	1.32

3412 = Converts Btu to kWh

ADJ_{WallHeat} = Adjustment for heating savings to account for inaccuracies in prescriptive engineering algorithms. ¹⁵⁹⁹

= 63%

%ElectricHeat = Percent of homes that have electric space heating

= 100 % for Electric Resistance or Heat Pump

= 0 % for Fossil Fuel heating

= If unknown¹⁶⁰⁰, use the following table:

Utility	Location				
	Single Family	Single Family Low Income	Multi Family	Multi Family Low Income	Unknown
Ameren	18%	26%	38%	39%	29%
ComEd	14%	22%	43%	48%	21%
PGL	1.0%	1.5%	4.0%	2.8%	2.2%
NSG	1.3%	0.8%	32.5%	1.2%	3.3%
Nicor	1.3%	0.8%	32.5%	1.2%	3.3%

Heat Pumps was adjusted. While one would expect the average system efficiency to be higher than this minimum, the likely degradation of efficiencies over time means that using the minimum standard is appropriate. An 85% distribution efficiency is then applied to account for duct losses for heat pumps. Note all ratings have been converted to HSPF2 equivalents – since the new rating better reflects the actual efficiency of the units.

¹⁵⁹⁹ Justification for degradation factors can be found on page 14 of ‘AIC HVAC Metering Study Memo FINAL 2_28_2018’. Estimate efficiency as (Rated Efficiency * (1-0.01)^{Equipment Age}).

¹⁵⁹⁹ TAC negotiated adjustment factor was 60%. During update cycle for version v.12, applied the percent change of NCEI Annual Normals HDD60 from 30 yr data set (1981-2010) to more recent 15 yr data (2006-2020) for all heating-related adjustment values.

¹⁶⁰⁰ Based on the average % Natural Gas used for space heating in Unknown residential structure types across all utilities covered by the IL program. Residence types include: SF, SF LI, MF & MF LI. Utilities included: Ameren, ComEd, People’s Gas, Northshore Gas & Nicor. Data provided from 2016 Ameren Illinois Demand Side Management (DSM) Market Potential Study by Applied Energy Group, ComEd’s 2019 Baseline Survey on residential space heating share, and PY2022-2023 Implementation Contractors Data for People’s Gas, Northshore Gas & Nicor .

Utility	Location				
	Single Family	Single Family Low Income	Multi Family	Multi Family Low Income	Unknown
All DUs ¹⁶⁰¹					26%

Note: If a measure is supported by a gas and electric utility through a joint program, and it is unknown whether the participant has a gas supply, the electric utility values in the table above should be used. If it is known that the participant has a gas supply, the values from the gas utility above should be applied.

For example, a single family home in Chicago with 990 ft² of R-5 walls insulated to R-11, 10.5 SEER Central AC and 2.26 (1.92 including distribution losses) COP Heat Pump:

$$\begin{aligned} \Delta kWh &= (\Delta kWh_{cooling} + \Delta kWh_{heating}) \\ &= (((((1/5 - 1/11) * 990 * (1-0.25)) * 1,047 * 0.75 * 24) / (1,000 * 10.5)) * 75% * 100\%) + (((((1/5 - 1/11) * 990 * (1-0.25)) * 4,798 * 24) / (1.92 * 3,412)) * 63% * 100\%) \\ &= 109.0 + 897 \end{aligned}$$

$$\begin{aligned} \Delta kWh_{heatingFurnace} &= \text{If fossil fuel } furnace \text{ heat, kWh savings for reduction in fan run time} \\ &= \Delta Therms * F_e * 29.3 \end{aligned}$$

$$\begin{aligned} F_e &= \text{Furnace Fan energy consumption as a percentage of annual fuel consumption} \\ &= 3.14\%^{1602} \end{aligned}$$

$$29.3 = \text{kWh per therm}$$

For example, a single family home in Chicago with 990 ft² of R-5 walls insulated to R-11 with a gas furnace with system efficiency of 66% (for therm calculation see Fossil Fuel Savings section):

$$\begin{aligned} \Delta kWh_{heatingGas} &= 89.0 * 0.0314 * 29.3 \\ &= 81.9 \text{ kWh} \end{aligned}$$

SUMMER COINCIDENT PEAK DEMAND SAVINGS

$$\Delta kW = (\Delta kWh_{cooling} / FLH_{cooling}) * CF$$

Where:

$$\begin{aligned} FLH_{cooling} &= \text{Full load hours of air conditioning} \\ &= \text{Dependent on location as below.}^{1603} \end{aligned}$$

¹⁶⁰¹ For the weighted average calculations, please see the Analysis file. PGL, NSG, Nicor & gas customers were assumed to follow the provided split. ComEd total customers, minus overlap with PGL, NSG & Nicor, therefore electric only homes. Ameren is total customers minus Nicor.

¹⁶⁰² F_e is not one of the AHRI certified ratings provided for residential furnaces, but can be reasonably estimated from a calculation based on the certified values for fuel energy (E_f in MMBtu/yr) and E_{ae} (kWh/yr). An average of a 300 record sample (non-random) out of 1495 was 3.14%. This is, appropriately, ~50% greater than the ENERGY STAR version 3 criteria for 2% F_e. See "Programmable Thermostats Furnace Fan Analysis.xlsx" for reference.

¹⁶⁰³ Full load hours for Chicago, Moline and Rockford are provided in "Final Evaluation Report: Central Air Conditioning Efficiency Services (CACES), 2010, Navigant Consulting", p.33. An average FLH/Cooling Degree Day (from NCDC) ratio was calculated for these locations and applied to the CDD of the other locations in order to estimate FLH. There is a county mapping table in Volume 1, Section 3.7 providing the appropriate city to use for each county of Illinois. During update cycle for version v.12, applied percent change of CDD65, NCEI Annual Normals from 30 yr data set (1981-2010) to more recent 15 yr data (2006-2020) to all FLHcool values.

Climate Zone (City based upon)	Single Family	Multifamily
1 (Rockford)	547	499
2 (Chicago)	709	629
3 (Springfield)	779	707
4 (Belleville)	1082	982
5 (Marion)	956	868
Weighted Average ¹⁶⁰⁴		
ComEd	676	603
Ameren	875	791
Statewide	731	655

Use Multifamily if: Building meets utility’s definition for multifamily and HVAC system serves single unit. For residential sized systems serving 2 or more units, assume single family hours.

- CF_{SSP} = Summer System Peak Coincidence Factor for Central A/C (during utility peak hour)
= 68%¹⁶⁰⁵
- CF_{SSP SF} = Summer System Peak Coincidence Factor for Heat Pumps in single family homes (during system peak hour)
= 72%¹⁶⁰⁶
- CF_{SSP, MF} = Summer System Peak Coincidence Factor for Heat Pumps in multifamily homes (during system peak hour)
= 67%¹⁶⁰⁷
- CF_{PJM} = PJM Summer Peak Coincidence Factor for Central A/C (average during PJM peak period)
= 46.6%¹⁶⁰⁸
- CF_{PJM SF} = PJM Summer Peak Coincidence Factor for Heat Pumps in single family homes (average during PJM peak period)
= 46.6%¹⁶⁰⁹
- CF_{PJM, MF} = PJM Summer Peak Coincidence Factor for Heat Pumps in multifamily homes (average during peak period)
= 28.5%

¹⁶⁰⁴ Weighting for Ameren is based on electric accounts in each of the cooling zones. Weighting for ComEd and Statewide average is based on number of occupied residential housing units in each zone. ComEd is weighted average of Zones 1-2. Alternative program-weighted assumptions can be used if appropriate.

¹⁶⁰⁵ Based on metering of 24 homes with central AC during PY4 and PY5 in Ameren Illinois service territory.

¹⁶⁰⁶ Based on analysis of metering results from 24 heat pumps in Ameren Illinois service territory in PY5 coincident with AIC’s 2010 system peak; ‘Impact and Process Evaluation of Ameren Illinois Company’s Residential HVAC Program (PY5)’.

¹⁶⁰⁷ Multifamily coincidence factors both from; *All-Electric Homes PY6 Metering Results: Multifamily HVAC Systems*, Cadmus, October 2015

¹⁶⁰⁸ Based on analysis of Itron eShape data for Missouri, calibrated to Illinois loads, supplied by Ameren. The average AC load over the PJM peak period (1-5pm, M-F, June through August) is divided by the maximum AC load during the year.

¹⁶⁰⁹ Based on analysis of Itron eShape data for Missouri, calibrated to Illinois loads, supplied by Ameren. The average AC load over the PJM peak period (1-5pm, M-F, June through August) is divided by the maximum AC load during the year.

For example, a single family home in Chicago with 990 ft² of R-5 walls insulated to R-11, 10.5 SEER Central AC, and 2.26 COP Heat Pump:

$$\begin{aligned} \Delta kW_{SSP} &= 109.0 / 709 * 0.68 \\ &= 0.10 \text{ kW} \end{aligned}$$

$$\begin{aligned} \Delta kW_{PJM} &= 109.0 / 709 * 0.466 \\ &= 0.07 \text{ kW} \end{aligned}$$

FOSSIL FUEL SAVINGS

If Fossil Fuel heating:

$$\Delta \text{Therms} = (((1/R_{old} - 1/R_{wall}) * A_{wall} * (1 - \text{Framing_factor_wall}) * 24 * \text{HDD}) / (\eta_{Heat} * 100,000 \text{ Btu/therm})) * \text{ADJ}_{\text{WallHeat}} * \% \text{FossilHeat}$$

Where:

HDD = Heating Degree Days
 = Dependent on location:¹⁶¹⁰

Climate Zone (City based upon)	HDD 60
1 (Rockford)	5230
2 (Chicago)	4798
3 (Springfield)	4266
4 (Belleville)	3188
5 (Marion)	3390
Weighted Average ¹⁶¹¹	4631

η_{Heat} = Efficiency of heating system
 = Equipment efficiency * distribution efficiency
 = Actual (where it is possible to measure or reasonably estimate).¹⁶¹² Note where new HVAC is installed in addition to shell measures, the old HVAC unit efficiency should be used and the shell measure savings calculated first, the HVAC measure then assuming the reduced heat/cooling loads. If using rated efficiencies, derate efficiency value by 1% per year (maximum of 30 years) to account for degradation over time,¹⁶¹³ or if unknown assume 72% for existing system efficiency.¹⁶¹⁴ If unknown value is used, it should not be derated by age. If actual Distribution Efficiency is not available, use 85%.

$\% \text{FossilHeat}$ = Percent of homes that have fossil fuel space heating

¹⁶¹⁰ National Centers for Environmental Information (NCEI) Annual Normals, from 2006 - 2020, calculated with a base temp of 60°F, consistent with the findings of Belzer and Cort, Pacific Northwest National Laboratory in “Statistical Analysis of Historical State-Level Residential Energy Consumption Trends,” 2004. There is a county mapping table in Volume 1, Section 3.7 providing the appropriate city to use for each county of Illinois.

¹⁶¹¹ Weighted based on number of occupied residential housing units in each zone (US Census 2010).

¹⁶¹² Ideally, the System Efficiency should be obtained either by recording the AFUE of the unit, or performing a steady state efficiency test. The Distribution Efficiency can be estimated via a visual inspection and by referring to a look up table such as that provided by the Building Performance Institute: (see ‘BPI Distribution Efficiency Table’) or by performing duct blaster testing.

¹⁶¹³ Justification for degradation factors can be found on page 14 of ‘AIC HVAC Metering Study Memo FINAL 2_28_2018’. Estimate efficiency as (Rated Efficiency * (1-0.01)^{Equipment Age}).

¹⁶¹⁴ Based on average Nicor PY4 nameplate efficiencies derated by 15% for distribution losses.

- = 100 % for Fossil Fuel heating
- = 0 % for Electric Resistance or Heat Pump
- = If unknown¹⁶¹⁵, use the following table:

Utility	Location				
	Single Family	Single Family Low Income	Multi Family	Multi Family Low Income	Unknown
Ameren	82%	74%	62%	61%	71%
ComEd	86%	78%	57%	52%	79%
PGL	98.9%	98.5%	96.0%	96.9%	97.7%
NSG	98.3%	99.2%	67.5%	98.8%	96.6%
Nicor	98.3%	99.2%	67.5%	98.8%	96.6%
All DUs¹⁶¹⁶					74%

Note: If a measure is supported by a gas and electric utility through a joint program, and it is unknown whether the participant has a gas supply, the electric utility values in the table above should be used. If it is known that the participant has a gas supply, the values from the gas utility above should be applied.

Other factors as defined above.

For example, a single family home in Chicago with 990 ft² of R-5 walls insulated to R-11, with a gas furnace with system efficiency of 66%:

$$\Delta \text{Therms} = (((1/5 - 1/11) * 990 * (1-0.25)) * 24 * 4798) / (0.66 * 100,000) * 63\% * 100\%$$

$$= 89.0 \text{ therms}$$

Mid-Life adjustment

In order to account for the likely replacement of existing heating and cooling equipment during the lifetime of this measure, a mid-life adjustment should be applied. To calculate the adjustment, re-calculate the savings above using the following new baseline system efficiency assumptions:

Efficiency Assumption	System Type	New Baseline Efficiency
ηCool	Central AC	13.4 SEER2
	Heat Pump	14.3 SEER2
ηHeat	Electric Resistance	1.0 COP
	Heat Pump (7.5HSPF/3.413)*0.85	1.87 COP
	Gas Furnace 80% AFUE * 0.85	68% AFUE
	Oil Furnace 83% AFUE * 0.85	71% AFUE

¹⁶¹⁵ Based on the average % Natural Gas used for space heating in Unknown residential structure types across all utilities covered by the IL program. Residence types include: SF, SF LI, MF & MF LI. Utilities included: Ameren, ComEd, People’s Gas, Northshore Gas & Nicor. Data provided from 2016 Ameren Illinois Demand Side Management (DSM) Market Potential Study by Applied Energy Group, ComEd’s 2019 Baseline Survey on residential space heating share, and PY2022-2023 Implementation Contractors Data for People’s Gas, Northshore Gas & Nicor .

¹⁶¹⁶ For the weighted average calculations, please see the Analysis file. PGL, NSG, Nicor & gas customers were assumed to follow the provided split. ComEd total customers, minus overlap with PGL,NSG & Nicor, therefore gas only homes. Ameren is total customers minus Nicor.

Efficiency Assumption	System Type	New Baseline Efficiency
	Gas Boiler	84% AFUE
	Oil Boiler	86% AFUE

This reduced annual savings should be applied following the assumed remaining useful life of the existing equipment, estimate to be 10 years or 13 years for boilers.¹⁶¹⁷ Note if the existing equipment efficiency is greater than the new baseline efficiency listed above, do not apply a mid-life adjustment.

WATER IMPACT DESCRIPTIONS AND CALCULATION

N/A

DEEMED O&M COST ADJUSTMENT CALCULATION

N/A

MEASURE CODE: RS-SHL-WINS-V14-250101

REVIEW DEADLINE: 1/1/2030

¹⁶¹⁷ This is intentionally longer than the assumption found in the early replacement measures as the application of this measure will occur in a variety of homes and will not be targeting those homes appropriate for early replacement HVAC systems.

5.6.5 Ceiling/Attic Insulation

DESCRIPTION

Insulation is added to the attic. This measure requires a member of the implementation staff evaluating the pre and post R-values and measure surface areas. The efficiency of the heating and cooling equipment in the home should also be evaluated if possible.

This measure was developed to be applicable to the following program types: RF.

If applied to other program types, the measure savings should be verified.

DEFINITION OF EFFICIENT EQUIPMENT

This measure requires a member of the implementation staff or a participating contractor to evaluate the pre and post R-values and measure surface areas. The requirements for participation in the program will be defined by the utilities.

DEFINITION OF BASELINE EQUIPMENT

The existing condition will be evaluated by implementation staff or a participating contractor and is likely to be little or no attic insulation.

DEEMED LIFETIME OF EFFICIENT EQUIPMENT

The expected measure life is assumed to be 30 years.¹⁶¹⁸

Note a mid-life adjustment to account for replacement of HVAC equipment during the measure life should be applied after 10 years or 13 years for boilers.¹⁶¹⁹ See section below for detail.

DEEMED MEASURE COST

The actual installed cost for this measure should be used in screening.

LOADSHAPE

- Loadshape R08 - Residential Cooling
- Loadshape R09 - Residential Electric Space Heat
- Loadshape R10 - Residential Electric Heating and Cooling

COINCIDENCE FACTOR

The summer peak coincidence factor for cooling is provided in two different ways below. The first is used to estimate peak savings during the utility peak hour and is most indicative of actual peak benefits, and the second represents the *average* savings over the defined summer peak period, and is presented so that savings can be bid into PJM's capacity market.

- CF_{SSP} = Summer System Peak Coincidence Factor for Central A/C (during utility peak hour)
= 68%¹⁶²⁰
- CF_{SSP SF} = Summer System Peak Coincidence Factor for Heat Pumps in single family homes (during system peak hour)

¹⁶¹⁸ As recommended in Guidehouse 'EMV Group A, Deliverable 16 EUL Research – Residential Insulation', prepared for California Public Utilities Commission, June 2021.

¹⁶¹⁹ This is intentionally longer than the assumptions found in the early replacement measures as the application of this measure will occur in a variety of homes that will not be targeted for early replacement HVAC systems.

¹⁶²⁰ Based on metering of 24 homes with central AC during PY4 and PY5 in Ameren Illinois service territory.

	= 72% ¹⁶²¹
CF _{SSP, MF}	= Summer System Peak Coincidence Factor for Heat Pumps in multifamily homes (during system peak hour) = 67% ¹⁶²²
CF _{PJM}	= PJM Summer Peak Coincidence Factor for Central A/C (average during PJM peak period) = 46.6% ¹⁶²³
CF _{PJM SF}	= PJM Summer Peak Coincidence Factor for Heat Pumps in single family homes (average during PJM peak period) = 46.6% ¹⁶²⁴
CF _{PJM, MF}	= PJM Summer Peak Coincidence Factor for Heat Pumps in multifamily homes (average during peak period) = 28.5%

Algorithm

CALCULATION OF SAVINGS

ELECTRIC ENERGY SAVINGS

Where available savings from shell insulation measures should be determined through a custom analysis. When that is not feasible for the program the following engineering algorithms can be used with the inclusion of an adjustment factor to de-rate the heating savings.

$$\Delta kWh = (\Delta kWh_{cooling} + \Delta kWh_{heatingElectric} + \Delta kWh_{heatingFurnace})$$

Where:

- $\Delta kWh_{cooling}$ = If central cooling, reduction in annual cooling requirement due to ceiling/attic insulation
= $\frac{(((1/R_{old} - 1/R_{attic}) * A_{attic} * (1 - Framing_factor_attic)) * 24 * CDD * DUA) / (1000 * \eta_{Cool}) * ADJ_{AtticCool} * IENetCorrection * \%Cool}$
- R_{attic} = R-value of new attic assembly (including all layers between inside air and outside air).
- R_{old} = R-value value of existing assembly and any existing insulation.
(Minimum of R-3 for uninsulated assemblies)¹⁶²⁵
- A_{attic} = Total area of insulated ceiling/attic (ft²)
- Framing_factor_attic = Adjustment to account for area of framing
= 7%¹⁶²⁶

¹⁶²¹ Based on analysis of metering results from 24 heat pumps in Ameren Illinois service territory in PY5 coincident with AIC's 2010 system peak; 'Impact and Process Evaluation of Ameren Illinois Company's Residential HVAC Program (PY5)'.

¹⁶²² Multifamily coincidence factors both from; *All-Electric Homes PY6 Metering Results: Multifamily HVAC Systems*, Cadmus, October 2015

¹⁶²³ Based on analysis of Itron eShape data for Missouri, calibrated to Illinois loads, supplied by Ameren. The average AC load over the PJM peak period (1-5pm, M-F, June through August) is divided by the maximum AC load during the year.

¹⁶²⁴ Based on analysis of Itron eShape data for Missouri, calibrated to Illinois loads, supplied by Ameren. The average AC load over the PJM peak period (1-5pm, M-F, June through August) is divided by the maximum AC load during the year.

¹⁶²⁵ Component estimate of airfilm above and below, sheathing and sheet rock, (0.68+0.5+0.45+0.68 = 2.3) is rounded up to R-3.

¹⁶²⁶ Ibid.

- 24 = Converts hours to days
- CDD = Cooling Degree Days
= dependent on location:¹⁶²⁷

Climate Zone (City based upon)	CDD 65
1 (Rockford)	877
2 (Chicago)	1047
3 (Springfield)	1183
4 (Belleville)	1641
5 (Marion)	1450
Weighted Average ¹⁶²⁸	1098

- DUA = Discretionary Use Adjustment (reflects the fact that people do not always operate their AC when conditions may call for it).
= 0.75 ¹⁶²⁹
- 1000 = Converts Btu to kBtu
- η Cool = Seasonal Energy Efficiency Ratio of cooling system (kBtu/kWh)

= Actual (where it is possible to measure or reasonably estimate). Note where new HVAC is installed in addition to shell measures, the old HVAC unit efficiency should be used and the shell measure savings calculated first, the HVAC measure then assuming the reduced heat/cooling loads. If using rated efficiencies, derate efficiency value by 1% per year (maximum of 30 years) to account for degradation over time,¹⁶³⁰ or if unknown assume the following.¹⁶³¹ If unknown value is used, it should not be derated by age.

Age of Equipment	SEER2 Estimate
Before 2006	9.5
2006 - 2014	12.4
Central AC After 1/1/2015	12.4
Heat Pump After 1/1/2015	13.3
Unknown (for use in program evaluation only)	10.0

¹⁶²⁷ National Centers for Environmental Information (NCEI) Annual Normals, from 2006 - 2020, calculated with a base temp of 65°F. There is a county mapping table Volume 1, Section 3.7 providing the appropriate city to use for each county of Illinois.

¹⁶²⁸ Weighted based on number of occupied residential housing units in each zone (US Census 2010).

¹⁶²⁹ This factor's source is: Energy Center of Wisconsin, May 2008 metering study; "Central Air Conditioning in Wisconsin, A Compilation of Recent Field Research", p31.

¹⁶³⁰ Justification for degradation factors can be found on page 14 of 'A/C HVAC Metering Study Memo FINAL 2_28_2018'. Estimate efficiency as (Rated Efficiency * (1-0.01)^Equipment Age).

¹⁶³¹ These default system efficiencies are based on the applicable minimum Federal Standards. In 2006 the Federal Standard for Central AC was adjusted. While one would expect the average system efficiency to be higher than this minimum, the likely degradation of efficiencies over time means that using the minimum standard is appropriate. Note all ratings have been converted to SEER2 equivalents – since the new rating better reflects the actual efficiency of the units.

ADJ_{AtticCool} = Adjustment for cooling savings to account for inaccuracies in engineering algorithms¹⁶³²
 = 114%

IE_{NetCorrection} = 100% if not income eligible or attic insulation is installed without air sealing
 = 110% if installing air sealing and attic insulation in income eligible projects with a deemed NTG value of 1.0 to offset net savings adjustment inherent when using ADJ_{AtticCool} of 114%¹⁶³³

%Cool = Percent of homes that have cooling

Central Cooling?	%Cool
Yes	100%
No	0%
Unknown (for use in program evaluation only) ¹⁶³⁴	66%

kWh_{heatingElectric} = If electric heat (resistance or heat pump), reduction in annual electric heating due to attic insulation

$$= \left(\left(\left(\frac{1}{R_{old}} - \frac{1}{R_{attic}} \right) * A_{attic} * (1 - \text{Framing_factor_attic}) \right) * 24 * \text{HDD} \right) / (\eta_{Heat} * 3,412) * \text{ADJ}_{AtticElectricHeat} * \%ElectricHeat$$

HDD = Heating Degree Days
 = Dependent on location:¹⁶³⁵

Climate Zone (City based upon)	HDD 60
1 (Rockford)	5230
2 (Chicago)	4798
3 (Springfield)	4266
4 (Belleville)	3188
5 (Marion)	3390
Weighted Average ¹⁶³⁶	4631

¹⁶³² As demonstrated in air sealing and insulation research by Navigant, see Navigant (2018). *ComEd and Nicor Gas Air Sealing and Insulation Research Report*. Presented to Commonwealth Edison Company and Nicor Gas Company. Adjustment factor was derived from a consumption data regression analysis with an experimental design that does not require further net savings adjustment for non-income eligible populations. During update cycle for version v.12, applied the percent change of NCEI Annual Normals CDD65 from 30 yr data set (1981-2010) to more recent 15 yr data (2006-2020) for all cooling-related adjustment values.

¹⁶³³ The additional value of 10% was selected to acknowledge that some portion of the regression-derived adjustment factors accounts for gross impact effects, and that removing net effects embedded in the adjustment factors would increase savings to some degree. A review of historical NTG values for air sealing and insulation measures in non-income eligible populations did not provide definitive guidance for estimating the net component of the adjustment factors. Historically, free ridership has ranged from 9% to 26% for like measures, and spillover has ranged from 1% to 14%, while NTGs have ranged from 0.75 to 1.05. The midpoint of the NTG range would be 0.90, a 10% reduction from 1.0.

¹⁶³⁴ Percentage of homes in Illinois that have central cooling from “Table HC7.9 Air Conditioning in Homes in Midwest Region, Divisions, and States, 2009” from Energy Information Administration, 2009 Residential Energy Consumption Survey

¹⁶³⁵ National Centers for Environmental Information (NCEI) Annual Normals, from 2006 - 2020, calculated with a base temp of 60°F, consistent with the findings of Belzer and Cort, Pacific Northwest National Laboratory in “Statistical Analysis of Historical State-Level Residential Energy Consumption Trends,” 2004. There is a county mapping table in Volume 1, Section 3.7 providing the appropriate city to use for each county of Illinois.

¹⁶³⁶ Weighted based on number of occupied residential housing units in each zone.

η_{Heat} = Efficiency of heating system
 = Actual Heating Efficiency * Distribution Efficiency (where it is possible to measure or reasonably estimate). Note where new HVAC is installed in addition to shell measures, the old HVAC unit efficiency should be used and the shell measure savings calculated first, the HVAC measure then assuming the reduced heat/cooling loads. If using rated efficiencies, derate efficiency value by 1% per year (maximum of 30 years) to account for degradation over time,¹⁶³⁷ or if not available refer to default table below.¹⁶³⁸ If unknown value is used, it should not be derated by age. If actual Distribution Efficiency is not available, use 85% for heat pumps.

System Type	Age of Equipment	HSPF2 Estimate	η_{Heat} (Effective COP Estimate * Distribution Efficiency) (HSPF2/3.413)*0.85
Heat Pump (if age unknown, assume 2006-2014)	Before 2006	5.8	1.44
	After 2006 -2014	6.5	1.62
	2015 on	7	1.74
Resistance	N/A	N/A	1
Unknown (for use in program evaluation only)	N/A	N/A	1.32

3412 = Converts Btu to kWh

$ADJ_{AtticElectricHeat}$ = Adjustment for electric heating savings to account for inaccuracies in engineering algorithms¹⁶³⁹
 = 63%

$\%ElectricHeat$ = Percent of homes that have electric space heating
 = 100 % for Electric Resistance or Heat Pump
 = 0 % for Fossil Fuel heat
 = If unknown¹⁶⁴⁰, use the following table:

¹⁶³⁷ Justification for degradation factors can be found on page 14 of 'AIC HVAC Metering Study Memo FINAL 2_28_2018'. Estimate efficiency as (Rated Efficiency * (1-0.01)^{Equipment Age}).

¹⁶³⁸ These default system efficiencies are based on the applicable minimum Federal Standards. In 2006 the Federal Standard for Heat Pumps was adjusted. While one would expect the average system efficiency to be higher than this minimum, the likely degradation of efficiencies over time means that using the minimum standard is appropriate. An 85% distribution efficiency is then applied to account for duct losses for heat pumps. Note all ratings have been converted to HSPF2 equivalents – since the new rating better reflects the actual efficiency of the units.

¹⁶³⁹ As demonstrated in air sealing and insulation research by Navigant, Navigant (2018). *ComEd and Nicor Gas Air Sealing and Insulation Research Report*. Presented to Commonwealth Edison Company and Nicor Gas Company. During update cycle for version v.12, applied the percent change of NCEI Annual Normals HDD60 from 30 yr data set (1981-2010) to more recent 15 yr data (2006-2020) for all heating-related adjustment values.

¹⁶⁴⁰ Based on the average % Natural Gas used for space heating in Unknown residential structure types across all utilities covered by the IL program. Residence types include: SF, SF LI, MF & MF LI. Utilities included: Ameren, ComEd, People’s Gas, Northshore Gas & Nicor. Data provided from 2016 Ameren Illinois Demand Side Management (DSM) Market Potential Study by Applied Energy Group, ComEd’s 2019 Baseline Survey on residential space heating share, and PY2022-2023 Implementation Contractors Data for People’s Gas, Northshore Gas & Nicor .

Utility	Location				
	Single Family	Single Family Low Income	Multi Family	Multi Family Low Income	Unknown
Ameren	18%	26%	38%	39%	29%
ComEd	14%	22%	43%	48%	21%
PGL	1.0%	1.5%	4.0%	2.8%	2.2%
NSG	1.3%	0.8%	32.5%	1.2%	3.3%
Nicor	1.3%	0.8%	32.5%	1.2%	3.3%
All DUs ¹⁶⁴¹					26%

Note: If a measure is supported by a gas and electric utility through a joint program, and it is unknown whether the participant has a gas supply, the electric utility values in the table above should be used. If it is known that the participant has a gas supply, the values from the gas utility above should be applied.

For example, energy savings from ceiling/attic insulation. Energy savings for air sealing are included in a separate example in Section 5.6.1: Air Sealing.

Assume a non-income eligible single family home in Chicago installs 700 ft² of attic insulation, completes air sealing, has 10.5 SEER Central AC and 2.26 (1.92 including distribution losses) COP Heat Pump, and has pre and post attic insulation R-values of R-5 and R-38, respectively:

$$\begin{aligned}
 \Delta kWh &= (\Delta kWh_{cooling} + \Delta kWh_{heating}) \\
 &= (((((1/5 - 1/38) * 700 * (1-0.07)) * 1,047 * 0.75 * 24) / (1,000 * 10.5)) * 114% * 100% * 100%) + (((((1/5 - 1/38) * 700 * (1-0.07)) * 4,798 * 24) / (1.92 * 3,412)) * 63% * 100%) \\
 &= 231 + 1,252 \\
 &= 1,483 kWh
 \end{aligned}$$

$$\begin{aligned}
 \Delta kWh_{heatingFurnace} &= \text{If fossil fuel } furnace \text{ heat, kWh savings for reduction in fan run time} \\
 &= \Delta Therms * F_e * 29.3 * ADJ_{AtticHeatFan}
 \end{aligned}$$

$$\begin{aligned}
 F_e &= \text{Furnace Fan energy consumption as a percentage of annual fuel consumption} \\
 &= 3.14\%^{1642}
 \end{aligned}$$

$$29.3 = \text{kWh per therm}$$

$$\begin{aligned}
 ADJ_{AtticHeatFan} &= \text{Adjustment for fan savings to account for inaccuracies in engineering algorithms}^{1643} \\
 &= 113\%
 \end{aligned}$$

¹⁶⁴¹ For the weighted average calculations, please see the Analysis file. PGL, NSG, Nicor & gas customers were assumed to follow the provided split. ComEd total customers, minus overlap with PGL, NSG & Nicor, therefore electric only homes. Ameren is total customers minus Nicor.

¹⁶⁴² F_e is not one of the AHRI certified ratings provided for residential furnaces, but can be reasonably estimated from a calculation based on the certified values for fuel energy (E_f in MMBtu/yr) and E_{ae} (kWh/yr). An average of a 300 record sample (non-random) out of 1495 was 3.14%. This is, appropriately, ~50% greater than the ENERGY STAR version 3 criteria for 2% F_e. See “Programmable Thermostats Furnace Fan Analysis.xlsx” for reference.

¹⁶⁴³ As demonstrated in air sealing and insulation research by Navigant, see Navigant (2018). *ComEd and Nicor Gas Air Sealing and Insulation Research Report*. Presented to Commonwealth Edison Company and Nicor Gas Company. Adjustment factor was derived from a consumption data regression analysis with an experimental design that does not require further net savings adjustment for non-income eligible populations. During update cycle for version v.12, applied the percent change of NCEI Annual Normals HDD60 from 30 yr data set (1981-2010) to more recent 15 yr data (2006-2020) for all heating-related adjustment values.

For example: energy savings from ceiling/attic insulation. Energy savings for air sealing are included in a separate example in Section 5.6.1: Air Sealing.

Assume a non-income eligible single family home in Chicago installs 700 ft² of attic insulation, completes air sealing, has a gas furnace with system efficiency of 66% (for therm calculation see Fossil Fuel Savings section), and has pre and post attic insulation R-values of R-5 and R-38, respectively:

$$\begin{aligned} \Delta kWh &= 150 * 0.0314 * 29.3 * 113\% \\ &= 156 \text{ kWh} \end{aligned}$$

SUMMER COINCIDENT PEAK DEMAND SAVINGS

$$\Delta kW = (\Delta kWh_{cooling} / FLH_{cooling}) * CF$$

Where:

FLH_{cooling} = Full load hours of air conditioning
 = Dependent on location as below:¹⁶⁴⁴

Climate Zone (City based upon)	Single Family	Multifamily
1 (Rockford)	547	499
2 (Chicago)	709	629
3 (Springfield)	779	707
4 (Belleville)	1082	982
5 (Marion)	956	868
Weighted Average ¹⁶⁴⁵		
ComEd	676	603
Ameren	875	791
Statewide	731	655

Use Multifamily if: Building meets utility’s definition for multifamily and HVAC system serves single unit. For residential sized systems serving 2 or more units, assume single family hours.

CF_{SSP} = Summer System Peak Coincidence Factor for Central A/C (during utility peak hour)
 = 68%¹⁶⁴⁶

CF_{SSP SF} = Summer System Peak Coincidence Factor for Heat Pumps in single family homes (during system peak hour)
 = 72%¹⁶⁴⁷

CF_{SSP, MF} = Summer System Peak Coincidence Factor for Heat Pumps in multifamily homes (during system peak hour)

¹⁶⁴⁴ Full load hours for Chicago, Moline and Rockford are provided in “Final Evaluation Report: Central Air Conditioning Efficiency Services (CACES), 2010, Navigant Consulting”, p.33. An average FLH/Cooling Degree Day (from NCDG) ratio was calculated for these locations and applied to the CDD of the other locations in order to estimate FLH. There is a county mapping table in Volume 1, Section 3.7 providing the appropriate city to use for each county of Illinois. During update cycle for version v.12, applied percent change of CDD65, NCEI Annual Normals from 30 yr data set (1981-2010) to more recent 15 yr data (2006-2020) to all FLHcool values.

¹⁶⁴⁵ Weighting for Ameren is based on electric accounts in each of the cooling zones. Weighting for ComEd and Statewide average is based on number of occupied residential housing units in each zone. ComEd is weighted average of Zones 1-2. Alternative program-weighted assumptions can be used if appropriate.

¹⁶⁴⁶ Based on metering of 24 homes with central AC during PY4 and PY5 in Ameren Illinois service territory.

¹⁶⁴⁷ Based on analysis of metering results from 24 heat pumps in Ameren Illinois service territory in PY5 coincident with AIC’s 2010 system peak; ‘Impact and Process Evaluation of Ameren Illinois Company’s Residential HVAC Program (PY5)’.

- = 67%¹⁶⁴⁸
- CF_{PJM} = PJM Summer Peak Coincidence Factor for Central A/C (average during PJM peak period)
= 46.6%¹⁶⁴⁹
- CF_{PJM, SF} = PJM Summer Peak Coincidence Factor for Heat Pumps in single family homes (average during PJM peak period)
= 46.6%¹⁶⁵⁰
- CF_{PJM, MF} = PJM Summer Peak Coincidence Factor for Heat Pumps in multifamily homes (average during peak period)
= 28.5%

For example, energy savings from ceiling/attic insulation. Energy savings for air sealing are included in a separate example in Section 5.6.1: Air Sealing.

Assume a non-income eligible single family home in Chicago installs 700 ft² of attic insulation, has 10.5 SEER Central AC and 2.26 COP Heat Pump, and has pre and post attic insulation R-values of R-5 and R-38, respectively:

$$\begin{aligned} \Delta kW_{SSP} &= 231 / 709 * 0.68 \\ &= 0.22 \text{ kW} \\ \Delta kW_{PJM} &= 156 / 709 * 0.466 \\ &= 0.10 \text{ kW} \end{aligned}$$

FOSSIL FUEL SAVINGS

If Fossil Fuel heating:

$$\Delta \text{Therms} = (((1/R_{old} - 1/R_{attic}) * A_{attic} * (1 - \text{Framing_factor_attic})) * 24 * \text{HDD}) / (\eta_{\text{Heat}} * 100,000 \text{ Btu/therm}) * \text{ADJ}_{\text{AtticGasHeat}} * \text{IE}_{\text{NetCorrection}} * \% \text{FossilHeat}$$

Where:

- HDD = Heating Degree Days
- = Dependent on location:¹⁶⁵¹

Climate Zone (City based upon)	HDD 60
1 (Rockford)	5230
2 (Chicago)	4798
3 (Springfield)	4266
4 (Belleville)	3188
5 (Marion)	3390

¹⁶⁴⁸ Multifamily coincidence factors both from; *All-Electric Homes PY6 Metering Results: Multifamily HVAC Systems*, Cadmus, October 2015

¹⁶⁴⁹ Based on analysis of Itron eShape data for Missouri, calibrated to Illinois loads, supplied by Ameren. The average AC load over the PJM peak period (1-5pm, M-F, June through August) is divided by the maximum AC load during the year.

¹⁶⁵⁰ Based on analysis of Itron eShape data for Missouri, calibrated to Illinois loads, supplied by Ameren. The average AC load over the PJM peak period (1-5pm, M-F, June through August) is divided by the maximum AC load during the year.

¹⁶⁵¹ National Centers for Environmental Information (NCEI) Annual Normals, from 2006 - 2020, calculated with a base temp of 60°F, consistent with the findings of Belzer and Cort, Pacific Northwest National Laboratory in "Statistical Analysis of Historical State-Level Residential Energy Consumption Trends," 2004. There is a county mapping table in Volume 1, Section 3.7 providing the appropriate city to use for each county of Illinois.

Climate Zone (City based upon)	HDD 60
Weighted Average ¹⁶⁵²	4631

- η_{Heat} = Efficiency of heating system

= Equipment efficiency * distribution efficiency

= Actual (where it is possible to measure or reasonably estimate).¹⁶⁵³ Note where new HVAC is installed in addition to shell measures, the old HVAC unit efficiency should be used and the shell measure savings calculated first, the HVAC measure then assuming the reduced heat/cooling loads. If using rated efficiencies, derate efficiency value by 1% per year (maximum of 30 years) to account for degradation over time,¹⁶⁵⁴ or if not available, use 72% for existing system efficiency.¹⁶⁵⁵ If unknown value is used, it should not be derated by age. If actual Distribution Efficiency is not available, use 85%.
- $ADJ_{AtticGasHeat}$ = Adjustment for gas heating savings to account for inaccuracies in engineering algorithms¹⁶⁵⁶

= 76%
- $IE_{NetCorrection}$ = 100% if not income eligible or attic insulation is installed without air sealing

= 110% if installing air sealing and attic insulation in income eligible projects with a deemed NTG value of 1.0 to offset net savings adjustment inherent when using $ADJ_{AtticGasHeat}$ of 76%¹⁶⁵⁷
- $\%FossilHeat$ = Percent of homes that have fossil fuel space heating

= 100 % for Fossil fuel heat

= 0 % for Electric Resistance or Heat Pump

= If unknown¹⁶⁵⁸, use the following table:

¹⁶⁵² Weighted based on number of occupied residential housing units in each zone (US Census 2010).

¹⁶⁵³ Ideally, the System Efficiency should be obtained either by recording the AFUE of the unit, or performing a steady state efficiency test. The Distribution Efficiency can be estimated via a visual inspection and by referring to a look up table such as that provided by the Building Performance Institute: (see 'BPI Distribution Efficiency Table') or by performing duct blaster testing.

¹⁶⁵⁴ Justification for degradation factors can be found on page 14 of 'AIC HVAC Metering Study Memo FINAL 2_28_2018'. Estimate efficiency as (Rated Efficiency * (1-0.01)^{Equipment Age}).

¹⁶⁵⁵ Based on average Nicor PY4 nameplate efficiencies derated by 15% for distribution losses.

¹⁶⁵⁶ As demonstrated in air sealing and insulation research by Navigant, Navigant (2018). *ComEd and Nicor Gas Air Sealing and Insulation Research Report*. Presented to Commonwealth Edison Company and Nicor Gas Company. Adjustment factor was derived from a consumption data regression analysis with an experimental design that does not require further net savings adjustment for non-income eligible populations. During update cycle for version v.12, applied the percent change of NCEI Annual Normals HDD60 from 30 yr data set (1981-2010) to more recent 15 yr data (2006-2020) for all heating-related adjustment values.

¹⁶⁵⁷ The additional value of 10% was selected to acknowledge that some portion of the regression-derived adjustment factors accounts for gross impact effects, and that removing net effects embedded in the adjustment factors would increase savings to some degree. A review of historical NTG values for air sealing and insulation measures in non-income eligible populations did not provide definitive guidance for estimating the net component of the adjustment factors. Historically, free ridership has ranged from 9% to 26% for like measures, and spillover has ranged from 1% to 14%, while NTGs have ranged from 0.75 to 1.05. The midpoint of the NTG range would be 0.90, a 10% reduction from 1.0.

¹⁶⁵⁸ Based on the average % Natural Gas used for space heating in Unknown residential structure types across all utilities covered by the IL program. Residence types include: SF, SF LI, MF & MF LI. Utilities included: Ameren, ComEd, People's Gas, Northshore Gas & Nicor. Data provided from 2016 Ameren Illinois Demand Side Management (DSM) Market Potential Study by Applied Energy Group, ComEd's 2019 Baseline Survey on residential space heating share, and PY2022-2023 Implementation Contractors Data for People's Gas, Northshore Gas & Nicor .

Utility	Location				
	Single Family	Single Family Low Income	Multi Family	Multi Family Low Income	Unknown
Ameren	82%	74%	62%	61%	71%
ComEd	86%	78%	57%	52%	79%
PGL	98.9%	98.5%	96.0%	96.9%	97.7%
NSG	98.3%	99.2%	67.5%	98.8%	96.6%
Nicor	98.3%	99.2%	67.5%	98.8%	96.6%
All DUs ¹⁶⁵⁹					74%

Note: If a measure is supported by a gas and electric utility through a joint program, and it is unknown whether the participant has a gas supply, the electric utility values in the table above should be used. If it is known that the participant has a gas supply, the values from the gas utility above should be applied.

Other factors as defined above.

For example, energy savings from ceiling/attic insulation. Energy savings for air sealing are included in a separate example in Section 5.6.1: Air Sealing.

Assume a non-income eligible single family home in Chicago installs 700 ft² of attic insulation, has a gas furnace with system efficiency of 66%, and has pre and post attic insulation R-values of R-5 and R-38, respectively:

$$\Delta\text{Therms} = (((1/5 - 1/38) * 700 * (1-0.07)) * 24 * 4,798) / (0.66 * 100,000) * 76\% * 100\% * 100\%$$

$$= 150 \text{ therms}$$

Mid-Life adjustment

In order to account for the likely replacement of existing heating and cooling equipment during the lifetime of this measure, a mid-life adjustment should be applied. To calculate the adjustment, re-calculate the savings above using the following new baseline system efficiency assumptions:

Efficiency Assumption	System Type	New Baseline Efficiency
ηCool	Central AC	13.4 SEER2
	Heat Pump	14.3 SEER2
ηHeat	Electric Resistance	1.0 COP
	Heat Pump (7.5HSPF/3.413)*0.85	1.87 COP
	Gas Furnace 80% AFUE * 0.85	68% AFUE
	Oil Furnace 83% AFUE * 0.85	71% AFUE
	Gas Boiler	84% AFUE
	Oil Boiler	86% AFUE

This reduced annual savings should be applied following the assumed remaining useful life of the existing equipment, estimate to be 10 years or 13 years for boilers.¹⁶⁶⁰ Note if the existing equipment efficiency is greater than the new

¹⁶⁵⁹ For the weighted average calculations, please see the Analysis file. PGL, NSG, Nicor & gas customers were assumed to follow the provided split. ComEd total customers, minus overlap with PGL,NSG & Nicor, therefore gas only homes. Ameren is total customers minus Nicor.

¹⁶⁶⁰ This is intentionally longer than the assumption found in the early replacement measures as the application of this measure will occur in a variety of homes and will not be targeting those homes appropriate for early replacement HVAC systems.

baseline efficiency listed above, do not apply a mid-life adjustment.

WATER IMPACT DESCRIPTIONS AND CALCULATION

N/A

DEEMED O&M COST ADJUSTMENT CALCULATION

N/A

MEASURE CODE: RS-SHL-AINS-V08-250101

REVIEW DEADLINE: 1/1/2030

5.6.6 Rim/Band Joist Insulation

DESCRIPTION

This measure describes savings from adding insulation (either rigid or spray foam) to rim/band joist cavities. This measure requires a member of the implementation staff evaluating the pre- and post-project R-values and to measure surface areas. The efficiency of the heating and cooling equipment in the home should also be evaluated if possible.

This measure was developed to be applicable to the following program types: RF.

If applied to other program types, the measure savings should be verified.

DEFINITION OF EFFICIENT EQUIPMENT

This measure requires a member of the implementation staff or a participating contractor to evaluate the pre and post R-values and measure surface areas. The requirements for participation in the program will be defined by the utilities.

DEFINITION OF BASELINE EQUIPMENT

The existing condition will be evaluated by implementation staff or a participating contractor and is likely to be empty wall cavities and little or no attic insulation.

DEEMED LIFETIME OF EFFICIENT EQUIPMENT

The expected measure life is assumed to be 30 years.¹⁶⁶¹

Note a mid-life adjustment to account for replacement of HVAC equipment during the measure life should be applied after 10 years or 13 years for boilers¹⁶⁶². See section below for detail.

DEEMED MEASURE COST

The actual installed cost for this measure should be used in screening.

LOADSHAPE

- Loadshape R08 - Residential Cooling
- Loadshape R09 - Residential Electric Space Heat
- Loadshape R10 - Residential Electric Heating and Cooling

COINCIDENCE FACTOR

The summer peak coincidence factor for cooling is provided in two different ways below. The first is used to estimate peak savings during the utility peak hour and is most indicative of actual peak benefits, and the second represents the *average* savings over the defined summer peak period, and is presented so that savings can be bid into PJM's capacity market.

- CF_{SSP} = Summer System Peak Coincidence Factor for Central A/C (during utility peak hour)
= 68%¹⁶⁶³
- CF_{SSP SF} = Summer System Peak Coincidence Factor for Heat Pumps in single family homes (during system peak hour)

¹⁶⁶¹ As recommended in Guidehouse 'EMV Group A, Deliverable 16 EUL Research – Residential Insulation', prepared for California Public Utilities Commission, June 2021.

¹⁶⁶² This is intentionally longer than the assumptions found in the early replacement measures as the application of this measure will occur in a variety of homes that will not be targeted for early replacement HVAC systems.

¹⁶⁶³ Based on metering of 24 homes with central AC during PY4 and PY5 in Ameren Illinois service territory.

	= 72% ¹⁶⁶⁴
CF _{SSP, MF}	= Summer System Peak Coincidence Factor for Heat Pumps in multifamily homes (during system peak hour) = 67% ¹⁶⁶⁵
CF _{PJM}	= PJM Summer Peak Coincidence Factor for Central A/C (average during PJM peak period) = 46.6% ¹⁶⁶⁶
CF _{PJM SF}	= PJM Summer Peak Coincidence Factor for Heat Pumps in single family homes (average during PJM peak period) = 46.6% ¹⁶⁶⁷
CF _{PJM, MF}	= PJM Summer Peak Coincidence Factor for Heat Pumps in multifamily homes (average during peak period) = 28.5%

Algorithm

CALCULATION OF SAVINGS

ELECTRIC ENERGY SAVINGS

Where available savings from shell insulation measures should be determined through a custom analysis. When that is not feasible for the program the following engineering algorithms can be used with the inclusion of an adjustment factor to de-rate the heating savings.

$$\Delta kWh = (\Delta kWh_{cooling} + \Delta kWh_{heatingElectric} + \Delta kWh_{heatingFurnace})$$

Where:

$\Delta kWh_{cooling}$ = If central cooling, reduction in annual cooling requirement due to insulation

$$= \frac{\left(\frac{1}{R_{old}} - \frac{1}{R_{Rim}}\right) * A_{Rim} * (1 - FramingFactor_{Rim}) * CDD * 24 * DUA * ADJ_{BasementCool* \%Cool}}{(1000 * \eta_{Cool})}$$

R_{Rim} = R-value of new rim/band joist assembly (including all layers between inside air and outside air).

R_{old} = R-value value of existing assembly and any existing insulation.
(Minimum of R-5 for uninsulated assemblies)¹⁶⁶⁸

A_{Rim} = Net area of insulated rim/band joist (ft²)

FramingFactor_{Rim} = Adjustment to account for area of framing

¹⁶⁶⁴ Based on analysis of metering results from 24 heat pumps in Ameren Illinois service territory in PY5 coincident with AIC's 2010 system peak; 'Impact and Process Evaluation of Ameren Illinois Company's Residential HVAC Program (PY5)'.

¹⁶⁶⁵ Multifamily coincidence factors both from; *All-Electric Homes PY6 Metering Results: Multifamily HVAC Systems*, Cadmus, October 2015

¹⁶⁶⁶ Based on analysis of Itron eShape data for Missouri, calibrated to Illinois loads, supplied by Ameren. The average AC load over the PJM peak period (1-5pm, M-F, June through August) is divided by the maximum AC load during the year.

¹⁶⁶⁷ Based on analysis of Itron eShape data for Missouri, calibrated to Illinois loads, supplied by Ameren. The average AC load over the PJM peak period (1-5pm, M-F, June through August) is divided by the maximum AC load during the year.

¹⁶⁶⁸ An estimate based on review of Madison Gas and Electric, Exterior Wall Insulation, R-value for no insulation in walls, and NREL's Building Energy Simulation Test for Existing Homes (BESTEST-EX).

= 5%¹⁶⁶⁹

24 = Converts hours to days

CDD = Cooling Degree Days

= dependent on location:¹⁶⁷⁰

Climate Zone (City based upon)	Conditioned CDD 65	Unconditioned (CDD 75) ¹⁶⁷¹
1 (Rockford)	877	326
2 (Chicago)	1047	354
3 (Springfield)	1183	448
4 (Belleville)	1641	532
5 (Marion)	1450	516
Weighted Average ¹⁶⁷²	1098	380

DUA = Discretionary Use Adjustment (reflects the fact that people do not always operate their AC when conditions may call for it).

= 0.75 ¹⁶⁷³

1000 = Converts Btu to kBtu

η Cool = Seasonal Energy Efficiency Ratio of cooling system (kBtu/kWh)

= Actual (where it is possible to measure or reasonably estimate). Note where new HVAC is installed in addition to shell measures, the old HVAC unit efficiency should be used and the shell measure savings calculated first, the HVAC measure then assuming the reduced heat/cooling loads. If using rated efficiencies, derate efficiency value by 1% per year (maximum of 30 years) to account for degradation over time,¹⁶⁷⁴ or if unknown assume the following.¹⁶⁷⁵ If unknown value is used, it should not be derated by age.

Age of Equipment	SEER2 Estimate
Before 2006	9.5
2006 - 2014	12.4
Central AC After 1/1/2015	12.4
Heat Pump After 1/1/2015	13.3
Unknown (for use in program evaluation only)	10.0

¹⁶⁶⁹ Assumes the average framing factor for joists running from front-to-back (0.094) and from side-to-side (0). The front-to-back FF was calculated based on 1.5" joists for every 16" (1.5"/16" = 0.094). The side-to-side FF is 0 since joists are continuous and uninterrupted.

¹⁶⁷⁰National Centers for Environmental Information (NCEI) Annual Normals, from 2006 - 2020, calculated with a base temp of 65°F. There is a county mapping table in Volume 1, Section 3.7 providing the appropriate city to use for each county of Illinois.

¹⁶⁷¹ Five year-average (2018 to 2022) cooling degree days with a base temperature of 75 F. Data from DegreeDays.net were used in this table because the climate normals from NCEI/NCDC used elsewhere are not available at base temps above 72F.

¹⁶⁷² Weighted based on number of occupied residential housing units in each zone (US Census 2010).

¹⁶⁷³ This factor's source is: Energy Center of Wisconsin, May 2008 metering study; "Central Air Conditioning in Wisconsin, A Compilation of Recent Field Research", p31.

¹⁶⁷⁴ Justification for degradation factors can be found on page 14 of 'A/C HVAC Metering Study Memo FINAL 2_28_2018'. Estimate efficiency as (Rated Efficiency * (1-0.01)^Equipment Age).

¹⁶⁷⁵ These default system efficiencies are based on the applicable minimum Federal Standards. In 2006 the Federal Standard for Central AC was adjusted. While one would expect the average system efficiency to be higher than this minimum, the likely degradation of efficiencies over time means that using the minimum standard is appropriate. Note all ratings have been converted to SEER2 equivalents – since the new rating better reflects the actual efficiency of the units.

$ADJ_{BasementCool}$ = Adjustment for cooling savings from basement wall and rim/band joist insulation to account for prescriptive engineering algorithms overclaiming savings¹⁶⁷⁶
 = 75%

$\%Cool$ = Percent of homes that have cooling

Central Cooling?	%Cool
Yes	100%
No	0%
Unknown (for use in program evaluation only) ¹⁶⁷⁷	66%

$kWh_{heatingElectric}$ = If electric heat (resistance or heat pump), reduction in annual electric heating due to insulation

$$= \frac{\left(\frac{1}{R_{old}} - \frac{1}{R_{Rim}}\right) * A_{Rim} * (1 - FramingFactor_{Rim}) * HDD * 24 * ADJ_{BasementHeat} * \%ElectricHeat}{(\eta_{Heat} * 3412)}$$

HDD = Heating Degree Days

= Dependent on :¹⁶⁷⁸

Climate Zone (City based upon)	Conditioned HDD 60	Unconditioned HDD 50
1 (Rockford)	5230	3233
2 (Chicago)	4798	2845
3 (Springfield)	4266	2456
4 (Belleville)	3188	1651
5 (Marion/Murphysboro)	3390	1750
Weighted Average ¹⁶⁷⁹	4631	2732

η_{Heat} = Efficiency of heating system

= Actual Heat Efficiency * Distribution Efficiency (where it is possible to measure or reasonably estimate). Note where new HVAC is installed in addition to shell measures, the old HVAC unit efficiency should be used and the shell measure savings calculated first, the HVAC measure then assuming the reduced heat/cooling loads. If using rated efficiencies, derate efficiency value by 1% per year (maximum of 30 years) to account for degradation over time,¹⁶⁸⁰ or if not

¹⁶⁷⁶ As demonstrated in two years of metering evaluation by Opinion Dynamics, see Memo “Results for AIC PY6 HPwES Billing Analysis”, dated February 20, 2015. TAC negotiated adjustment factor is 80%. During update cycle for version v.12, applied the percent change of NCEI Annual Normals CDD65 from 30 yr data set (1981-2010) to more recent 15 yr data (2006-2020) for all cooling-related adjustment values.

¹⁶⁷⁷ Percentage of homes in Illinois that have central cooling from “Table HC7.9 Air Conditioning in Homes in Midwest Region, Divisions, and States, 2009” from Energy Information Administration, 2009 Residential Energy Consumption Survey

¹⁶⁷⁸ National Centers for Environmental Information (NCEI) Annual Normals, from 2006 - 2020, calculated with a base temp of 60°F for a conditioned basement and 50°F for an unconditioned basement), consistent with the findings of Belzer and Cort, Pacific Northwest National Laboratory in “Statistical Analysis of Historical State-Level Residential Energy Consumption Trends,” 2004. There is a county mapping table in Volume 1, Section 3.7 providing the appropriate city to use for each county of Illinois.

¹⁶⁷⁹ Weighted based on number of occupied residential housing units in each zone.

¹⁶⁸⁰ Justification for degradation factors can be found on page 14 of ‘AIC HVAC Metering Study Memo FINAL 2_28_2018’. Estimate efficiency as (Rated Efficiency * (1-0.01)^Equipment Age).

available, refer to default table below.¹⁶⁸¹ If unknown value is used, it should not be derated by age. If actual Distribution Efficiency is not available, use 85% for heat pumps.

System Type	Age of Equipment	HSPF2 Estimate	η_{Heat} (Effective COP Estimate * Distribution Efficiency)= (HSPF2/3.413)*0.85
Heat Pump (if age unknown, assume 2006-2014)	Before 2006	5.8	1.44
	2006 - 2014	6.5	1.62
	2015 on	7.0	1.74
Resistance	N/A	N/A	1.00
Unknown (for use in program evaluation only) ¹⁶⁸²	N/A	N/A	1.32

3412 = Converts Btu to kWh

$ADJ_{\text{BasementHeat}}$ = Adjustment for basement wall and rim/band joist insulation to account for prescriptive engineering algorithms overclaiming savings¹⁶⁸³
= 63%

$\%ElectricHeat$ = Percent of homes that have electric space heating
= 100 % for Electric Resistance or Heat Pump
= 0 % for Fossil Fuel heat
= If unknown¹⁶⁸⁴, use the following table:

Utility	Location				
	Single Family	Single Family Low Income	Multi Family	Multi Family Low Income	Unknown
Ameren	18%	26%	38%	39%	29%
ComEd	14%	22%	43%	48%	21%

¹⁶⁸¹ These default system efficiencies are based on the applicable minimum Federal Standards. In 2006 the Federal Standard for Heat Pumps was adjusted. While one would expect the average system efficiency to be higher than this minimum, the likely degradation of efficiencies over time means that using the minimum standard is appropriate. An 85% distribution efficiency is then applied to account for duct losses for heat pumps. Note all ratings have been converted to HSPF2 equivalents – since the new rating better reflects the actual efficiency of the units.

¹⁶⁸² Justification for degradation factors can be found on page 14 of ‘AIC HVAC Metering Study Memo FINAL 2_28_2018’. Estimate efficiency as (Rated Efficiency * (1-0.01)^Equipment Age).

¹⁶⁸² These default system efficiencies are based on the applicable minimum Federal Standards. In 2006 the Federal Standard for Heat Pumps was adjusted. While one would expect the average system efficiency to be higher than this minimum, the likely degradation of efficiencies over time means that using the minimum standard is appropriate. An 85% distribution efficiency is then applied to account for duct losses for heat pumps.

¹⁶⁸³ TAC negotiated adjustment factor was 60%, then during update cycle for version v.12, applied the percent change of NCEI Annual Normals HDD60 from 30 yr data set (1981-2010) to more recent 15 yr data (2006-2020) for all heating-related adjustment values.

¹⁶⁸⁴ Based on the average % Natural Gas used for space heating in Unknown residential structure types across all utilities covered by the IL program. Residence types include: SF, SF LI, MF & MF LI. Utilities included: Ameren, ComEd, People’s Gas, Northshore Gas & Nicor. Data provided from 2016 Ameren Illinois Demand Side Management (DSM) Market Potential Study by Applied Energy Group, ComEd’s 2019 Baseline Survey on residential space heating share, and PY2022-2023 Implementation Contractors Data for People’s Gas, Northshore Gas & Nicor .

Utility	Location				
	Single Family	Single Family Low Income	Multi Family	Multi Family Low Income	Unknown
PGL	1.0%	1.5%	4.0%	2.8%	2.2%
NSG	1.3%	0.8%	32.5%	1.2%	3.3%
Nicor	1.3%	0.8%	32.5%	1.2%	3.3%
All DUs ¹⁶⁸⁵					26%

Note: If a measure is supported by a gas and electric utility through a joint program, and it is unknown whether the participant has a gas supply, the electric utility values in the table above should be used. If it is known that the participant has a gas supply, the values from the gas utility above should be applied.

For example, a single family home in Chicago with 100 ft² of uninsulated rim joist cavities in an unconditioned basement that is insulated to R-13. The home has 10.5 SEER Central AC and 2.26 (1.92 including distribution losses) COP Heat Pump:

$$\begin{aligned} \Delta kWh &= (\Delta kWh_{cooling} + \Delta kWh_{heating}) \\ &= (((1/5 - 1/13) * 100 * (1-0.05) * 281 * 24 * 0.75 * 1 * .75) / (1000 * 10.5)) + (((1/5 - 1/13) * 100 * (1-0.05) * 2845 * 24 * 0.63 * 1) / (1.92 * 3412)) \\ &= 5.3 + 76.8 \\ &= 842.1 kWh \end{aligned}$$

$$\begin{aligned} \Delta kWh_{heatingFurnace} &= \text{If fossil fuel furnace heat, kWh savings for reduction in fan run time} \\ &= \Delta Therms * F_e * 29.3 \end{aligned}$$

$$\begin{aligned} F_e &= \text{Furnace Fan energy consumption as a percentage of annual fuel consumption} \\ &= 3.14\%^{1686} \end{aligned}$$

$$29.3 = \text{kWh per therm}$$

For example, a single family home in Chicago with 100 ft² of uninsulated rim joist cavities in an unconditioned basement that is insulated to R-13. The home has a gas furnace with system efficiency of 66% (for therm calculation see Fossil Fuel Savings section):

$$\begin{aligned} \Delta kWh &= 7.62 * 0.0314 * 29.3 \\ &= 7.0 kWh \end{aligned}$$

SUMMER COINCIDENT PEAK DEMAND SAVINGS

$$\Delta kW = (\Delta kWh_{cooling} / FLH_{cooling}) * CF$$

Where:

$$FLH_{cooling} = \text{Full load hours of air conditioning}$$

¹⁶⁸⁵ For the weighted average calculations, please see the Analysis file. PGL, NSG, Nicor & gas customers were assumed to follow the provided split. ComEd total customers, minus overlap with PGL,NSG & Nicor, therefore electric only homes. Ameren is total customers minus Nicor.

¹⁶⁸⁶ F_e is not one of the AHRI certified ratings provided for residential furnaces, but can be reasonably estimated from a calculation based on the certified values for fuel energy (E_f in MMBtu/yr) and E_{ae} (kWh/yr). An average of a 300 record sample (non-random) out of 1495 was 3.14%. This is, appropriately, ~50% greater than the ENERGY STAR version 3 criteria for 2% F_e. See “Programmable Thermostats Furnace Fan Analysis.xlsx” for reference.

= Dependent on location as below:¹⁶⁸⁷

Climate Zone (City based upon)	Single Family	Multifamily
1 (Rockford)	547	499
2 (Chicago)	709	629
3 (Springfield)	779	707
4 (Belleville)	1082	982
5 (Marion)	956	868
Weighted Average ¹⁶⁸⁸		
ComEd	676	603
Ameren	875	791
Statewide	731	655

Use Multifamily if: Building meets utility’s definition for multifamily and HVAC system serves single unit. For residential sized systems serving 2 or more units, assume single family hours.

CF_{SSP} = Summer System Peak Coincidence Factor for Central A/C (during utility peak hour)
= 68%¹⁶⁸⁹

CF_{SSP SF} = Summer System Peak Coincidence Factor for Heat Pumps in single family homes (during system peak hour)
= 72%¹⁶⁹⁰

CF_{SSP, MF} = Summer System Peak Coincidence Factor for Heat Pumps in multifamily homes (during system peak hour)
= 67%¹⁶⁹¹

CF_{PJM} = PJM Summer Peak Coincidence Factor for Central A/C (average during PJM peak period)
= 46.6%¹⁶⁹²

CF_{PJM SF} = PJM Summer Peak Coincidence Factor for Heat Pumps in single family homes (average during PJM peak period)
= 46.6%¹⁶⁹³

¹⁶⁸⁷ Full load hours for Chicago, Moline and Rockford are provided in “Final Evaluation Report: Central Air Conditioning Efficiency Services (CACES), 2010, Navigant Consulting”, p.33. An average FLH/Cooling Degree Day (from NCEI) ratio was calculated for these locations and applied to the CDD of the other locations in order to estimate FLH. There is a county mapping table in Volume 1, Section 3.7 providing the appropriate city to use for each county of Illinois. During update cycle for version v.12, applied percent change of CDD65, NCEI Annual Normals from 30 yr data set (1981-2010) to more recent 15 yr data (2006-2020) to all FLHcool values.

¹⁶⁸⁸ Weighting for Ameren is based on electric accounts in each of the cooling zones. Weighting for ComEd and Statewide average is based on number of occupied residential housing units in each zone. ComEd is weighted average of Zones 1-2. Alternative program-weighted assumptions can be used if appropriate.

¹⁶⁸⁹ Based on metering of 24 homes with central AC during PY4 and PY5 in Ameren Illinois service territory.

¹⁶⁹⁰ Based on analysis of metering results from 24 heat pumps in Ameren Illinois service territory in PY5 coincident with AIC’s 2010 system peak; ‘Impact and Process Evaluation of Ameren Illinois Company’s Residential HVAC Program (PY5)’.

¹⁶⁹¹ Multifamily coincidence factors both from; *All-Electric Homes PY6 Metering Results: Multifamily HVAC Systems*, Cadmus, October 2015

¹⁶⁹² Based on analysis of Itron eShape data for Missouri, calibrated to Illinois loads, supplied by Ameren. The average AC load over the PJM peak period (1-5pm, M-F, June through August) is divided by the maximum AC load during the year.

¹⁶⁹³ Based on analysis of Itron eShape data for Missouri, calibrated to Illinois loads, supplied by Ameren. The average AC load over the PJM peak period (1-5pm, M-F, June through August) is divided by the maximum AC load during the year.

$CF_{PJM, MF}$ = PJM Summer Peak Coincidence Factor for Heat Pumps in multifamily homes (average during peak period)
 = 28.5%

For example, a single family home in Chicago with 100 ft² of uninsulated rim joist cavities in an unconditioned basement that is insulated to R-13. The home has 10.5 SEER Central AC and 2.26 (1.92 including distribution losses) COP Heat Pump:

$$\begin{aligned} \Delta kW_{SSP} &= 5.3 / 709 * 0.68 \\ &= 0.0051 \text{ kW} \\ \Delta kW_{PJM} &= 5.3 / 709 * 0.466 \\ &= 0.0035 \text{ kW} \end{aligned}$$

FOSSIL FUEL SAVINGS

If Fossil Fuel heating:

$$\Delta Therms = \frac{\left(\frac{1}{R_{old}} - \frac{1}{R_{Rim}}\right) * A_{Rim} * (1 - FramingFactor_{Rim}) * HDD * 24 * ADJ_{BasementHeat} * \%FossilHeat}{(\eta_{Heat} * 100,000)}$$

Where:

- η_{Heat} = Efficiency of heating system
 = Equipment efficiency * distribution efficiency
 = Actual (where it is possible to measure or reasonably estimate).¹⁶⁹⁴ Note where new HVAC is installed in addition to shell measures, the old HVAC unit efficiency should be used and the shell measure savings calculated first, the HVAC measure then assuming the reduced heat/cooling loads. If using rated efficiencies, derate efficiency value by 1% per year (maximum of 30 years) to account for degradation over time,¹⁶⁹⁵ or if not available, use 72% for existing system efficiency.¹⁶⁹⁶ If unknown value is used, it should not be derated by age. If actual Distribution Efficiency is not available.
- $\%FossilHeat$ = Percent of homes that have fossil fuel space heating
 = 100 % for Fossil Fuel heat
 = 0 % for Electric Resistance or Heat Pump
 = If unknown¹⁶⁹⁷, use the following table:

Utility	Location				
	Single Family	Single Family Low Income	Multi Family	Multi Family Low Income	Unknown
Ameren	82%	74%	62%	61%	71%
ComEd	86%	78%	57%	52%	79%

¹⁶⁹⁴ Ideally, the System Efficiency should be obtained either by recording the AFUE of the unit, or performing a steady state efficiency test. The Distribution Efficiency can be estimated via a visual inspection and by referring to a look up table such as that provided by the Building Performance Institute: (see 'BPI Distribution Efficiency Table') or by performing duct blaster testing.

¹⁶⁹⁵ Justification for degradation factors can be found on page 14 of 'AIC HVAC Metering Study Memo FINAL 2_28_2018'. Estimate efficiency as (Rated Efficiency * (1-0.01)^{Equipment Age}).

¹⁶⁹⁶ Based on average Nicor PY4 nameplate efficiencies derated by 15% for distribution losses.

¹⁶⁹⁷ Based on the average % Natural Gas used for space heating in Unknown residential structure types across all utilities covered by the IL program. Residence types include: SF, SF LI, MF & MF LI. Utilities included: Ameren, ComEd, People's Gas, Northshore Gas & Nicor. Data provided from 2016 Ameren Illinois Demand Side Management (DSM) Market Potential Study by Applied Energy Group, ComEd's 2019 Baseline Survey on residential space heating share, and PY2022-2023 Implementation Contractors Data for People's Gas, Northshore Gas & Nicor .

Utility	Location				
	Single Family	Single Family Low Income	Multi Family	Multi Family Low Income	Unknown
PGL	98.9%	98.5%	96.0%	96.9%	97.7%
NSG	98.3%	99.2%	67.5%	98.8%	96.6%
Nicor	98.3%	99.2%	67.5%	98.8%	96.6%
All DUs¹⁶⁹⁸					74%

Note: If a measure is supported by a gas and electric utility through a joint program, and it is unknown whether the participant has a gas supply, the electric utility values in the table above should be used. If it is known that the participant has a gas supply, the values from the gas utility above should be applied.

Other factors as defined above.

For example, a single family home in Chicago with 100 ft² of uninsulated rim joist cavities in an unconditioned basement that is insulated to R-13. The home has a gas furnace with system efficiency of 66%:

$$\begin{aligned} \Delta\text{Therms} &= ((1/5 - 1/13) * 100 * (1-0.05) * 2845 * 24 * 0.63 * 1) / (0.66 * 100,000) \\ &= 7.62 \text{ therms} \end{aligned}$$

Mid-Life adjustment

In order to account for the likely replacement of existing heating and cooling equipment during the lifetime of this measure, a mid-life adjustment should be applied. To calculate the adjustment, re-calculate the savings above using the following new baseline system efficiency assumptions:

Efficiency Assumption	System Type	New Baseline Efficiency
ηCool	Central AC	13.4 SEER2
	Heat Pump	14.3 SEER2
ηHeat	Electric Resistance	1.0 COP
	Heat Pump (7.5HSPF/3.413)*0.85	1.87 COP
	Gas Furnace 80% AFUE * 0.85	68% AFUE
	Oil Furnace 83% AFUE * 0.85	71% AFUE
	Gas Boiler	84% AFUE
	Oil Boiler	86% AFUE

This reduced annual savings should be applied following the assumed remaining useful life of the existing equipment, estimate to be 10 years or 13 years for boilers.¹⁶⁹⁹ Note if the existing equipment efficiency is greater than the new baseline efficiency listed above, do not apply a mid-life adjustment.

¹⁶⁹⁸ For the weighted average calculations, please see the Analysis file. PGL, NSG, Nicor & gas customers were assumed to follow the provided split. ComEd total customers, minus overlap with PGL,NSG & Nicor, therefore gas only homes. Ameren is total customers minus Nicor.

¹⁶⁹⁹ This is intentionally longer than the assumption found in the early replacement measures as the application of this measure will occur in a variety of homes and will not be targeting those homes appropriate for early replacement HVAC systems.

WATER IMPACT DESCRIPTIONS AND CALCULATION

N/A

DEEMED O&M COST ADJUSTMENT CALCULATION

N/A

MEASURE CODE: RS-SHL-RINS-V07-250101

REVIEW DEADLINE: 1/1/2030

5.6.7 Low-E Storm Window

DESCRIPTION

Emissivity is a measure of thermal radiation emitted by an object’s surface. Emissivity values range from 0 to 1 with 1 being the emissivity of a black body. Low emissivity (low-e) storm window inserts reduce the rate of thermal radiation of the window assembly through the interaction of multiple properties. The low-e surface of the insert means that the window will transfer heat at a reduced rate. The newly created air gap between the window and the insert combined with the low emissivity of the insert improves thermal performance of the window assembly. The inserts include weather-stripping as a means of sealing the connection which reduces air infiltration. This measure offers benefits during both heating and cooling seasons, for both natural gas and electricity. In addition to energy benefits, this measure offers non-energy benefits including increased comfort and noise reduction.

The calculation of savings presented in this section apply to single and multifamily residential applications with no portable window air conditioners. Small commercial applications with operating characteristics similar to a residential profile are also eligible for the savings presented here.

This measure was developed to be applicable to the following program types: RF, DI. If applied to other program types, the measure savings should be verified.

DEFINITION OF EFFICIENT EQUIPMENT

The efficient equipment is a window insert installed over either the interior or exterior of the baseline window. The insert must be ENERGY STAR certified and meet the ENERGY STAR storm windows key product criteria.

ENERGY STAR key product criteria for storm windows¹⁷⁰⁰

Climate Zone	Emissivity	Solar Transmission
1 - Rockford	≤ 0.22	> 0.55
2 - Chicago		
3 - Springfield		
4 - Belleville		Any
5 – Marion		

DEFINITION OF BASELINE EQUIPMENT

The baseline condition is an existing single-pane or double-pane window with clear glass and any frame type: metal, vinyl, or wood.

DEEMED LIFETIME OF EFFICIENT EQUIPMENT

The measure life is assumed to be 20 years.¹⁷⁰¹

DEEMED MEASURE COST

The incremental cost for this measure is \$7.85 per square foot material cost. Applications using professional window installers should include an additional \$30 per window installation cost.¹⁷⁰²

LOADSHAPE

- Loadshape R08 - Residential Cooling
- Loadshape R09 - Residential Electric Space Heat

¹⁷⁰⁰ ENERGY STAR Storm Windows Key Product Criteria, accessed February 2020.
¹⁷⁰¹ Pacific Northwest National Laboratory for the U.S. Department of Energy, “Task ET-WIN-PNNL-FY13-01-5.3: Database of Low-e Storm Window Energy Performance across U.S. Climate Zones,” September 2013: page 5.
¹⁷⁰² Ibid.

Loadshape R10 - Residential Electric Heating and Cooling

COINCIDENCE FACTOR

The summer peak coincidence factor for cooling is provided in two different ways below. The first is used to estimate peak savings during the utility peak hour and is most indicative of actual peak benefits, and the second represents the average savings over the defined summer peak period and is presented so that savings can be bid into PJM’s capacity market.

CF _{SSP}	= Summer System Peak Coincidence Factor for Central A/C (during utility peak hour) = 68% ¹⁷⁰³
CF _{SSP SF}	= Summer System Peak Coincidence Factor for Heat Pumps in single-family homes (during system peak hour) = 72% ¹⁷⁰⁴
CF _{SSP, MF}	= Summer System Peak Coincidence Factor for Heat Pumps in multi-family homes (during system peak hour) = 67% ¹⁷⁰⁵
CF _{PJM}	= PJM Summer Peak Coincidence Factor for Central A/C (average during PJM peak period) = 46.6% ¹⁷⁰⁶
CF _{PJM SF}	= PJM Summer Peak Coincidence Factor for Heat Pumps in single-family homes (average during PJM peak period) = 46.6% ¹⁷⁰⁷
CF _{PJM, MF}	= PJM Summer Peak Coincidence Factor for Heat Pumps in multi-family homes (average during peak period) = 28.5%

Algorithm

CALCULATION OF ENERGY SAVINGS

ELECTRIC ENERGY SAVINGS

$$\Delta kWh = \Delta kWh_{cooling} + \Delta kWh_{heatingElectric} + \Delta kWh_{heatingFurnace}$$

$$\Delta kWh_{cooling} = CS_{cz} * Area_{window}$$

$$\Delta kWh_{heatingElectric} = EHS_{cz} * Area_{window}$$

$$\Delta kWh_{heatingFurnace} = \Delta Therms * F_e * 29.3$$

¹⁷⁰³ Based on metering of 24 homes with central AC during PY4 and PY5 in Ameren Illinois service territory.

¹⁷⁰⁴ Based on analysis of metering results from 24 heat pumps in Ameren Illinois service territory in PY5 coincident with AIC’s 2010 system peak; ‘Impact and Process Evaluation of Ameren Illinois Company’s Residential HVAC Program (PY5)’.

¹⁷⁰⁵ Multifamily coincidence factors both from; *All-Electric Homes PY6 Metering Results: Multifamily HVAC Systems*, Cadmus, October 2015

¹⁷⁰⁶ Based on analysis of Itron eShape data for Missouri, calibrated to Illinois loads, supplied by Ameren. The average AC load over the PJM peak period (1-5pm, M-F, June through August) is divided by the maximum AC load during the year.

¹⁷⁰⁷ Based on analysis of Itron eShape data for Missouri, calibrated to Illinois loads, supplied by Ameren. The average AC load over the PJM peak period (1-5pm, M-F, June through August) is divided by the maximum AC load during the year.

Where:

CS_{cz} = Annual cooling savings per area of window by climate zone, see table below.

Cooling savings per window area by climate zone and baseline window condition¹⁷⁰⁸

Climate Zone	Single Pane Base Window (kWh/ft ²)	Double Pane Base Window (kWh/ft ²)
1 - Rockford	0.46	0.33
2 - Chicago	0.47	0.34
3 - Springfield	0.62	0.45
4 - Belleville	0.88	0.64
5 - Marion	0.77	0.56

EHS_{cz} = Annual electric heating savings per area of window by climate zone, see table below

Heating savings per window area by climate zone, heating type, and baseline window condition¹⁷⁰⁹

Climate Zone	Electric Resistance Heat		Electric Heat Pump	
	Single Pane Base Window (kWh/ft ²)	Double Pane Base Window (kWh/ft ²)	Single Pane Base Window (kWh/ft ²)	Double Pane Base Window (kWh/ft ²)
1 - Rockford	16.84	1.90	9.31	1.05
2 - Chicago	16.09	1.81	8.89	1.00
3 - Springfield	13.78	1.55	7.61	0.86
4 - Belleville	10.63	1.20	5.87	0.66
5 - Marion	10.82	1.22	5.98	0.67

$Area_{window}$ = Total area of installed window inserts. Use site specific value.

$\Delta Therms$ = Therm savings from fossil fuel heating as calculated below

F_e = Furnace Fan energy consumption as a percentage of annual fuel consumption, 3.14%¹⁷¹⁰

¹⁷⁰⁸ Based on savings modeled by EPA, “ES Storm Windows RESFEN Data and Calculations.xlsx”, April 2017. Whole House Cooling energy values from the “Raw Data-Exterior Storm Windows” and “Raw Data-Interior Storm Windows,” Climate Zone 5, Location IL Chicago, wood frame, single pane, exterior low-E (0.148 panel) and interior low-E (0.148 panel) were used to calculate savings. EPA only reported single pane modeling results. In order to estimate impacts for double pane windows, ratios of double pane to single pane cooling energy was applied as reported by the Pacific Northwest National Laboratory for the U.S. Department of Energy, “Task ET-WIN-PNNL-FY13-01-5.3: Database of Low-e Storm Window Energy Performance across U.S. Climate Zones,” September 2013. Values from Appendix C, table C.8 for Chicago, Illinois were used to calculate the ratio of double pane to single pane cooling energy. See “Low E Window Workpaper Supporting Calculations.xlsx” for reference. The was data modified for different heating zones of Illinois.

¹⁷⁰⁹ Based on savings modeled by EPA, “ES Storm Windows RESFEN Data and Calculations.xlsx”, April 2017. Whole House Heating energy values from the “Raw Data-Exterior Storm Windows” and “Raw Data-Interior Storm Windows,” Climate Zone 5, Location IL Chicago, wood frame, single pane, exterior low-E (0.148 panel) and interior low-E (0.148 panel) were used to calculate savings. EPA only reported single pane modeling results. In order to estimate impacts for double pane windows, ratios of double pane to single pane cooling energy was applied as reported by the Pacific Northwest National Laboratory for the U.S. Department of Energy, “Task ET-WIN-PNNL-FY13-01-5.3: Database of Low-e Storm Window Energy Performance across U.S. Climate Zones,” September 2013. Values from Appendix C, table C.8 for Chicago, Illinois were used to calculate the ratio of double pane to single pane heating energy. See “Low E Window Workpaper Supporting Calculations.xlsx” for reference. To convert from “Furnace” savings to electric, it is assumed a furnace efficiency of 72%, electric resistance of 100% and heat pump of 1.81 (average of pre-2006 and 2006-2014 federal standard).

¹⁷¹⁰ F_e is not one of the AHRI certified ratings provided for residential furnaces, but can be reasonably estimated from a

29.3 = Conversion factor, kWh per therm

SUMMER COINCIDENT PEAK DEMAND SAVINGS

$$\Delta kW = \left(\frac{\Delta kWh_{cooling}}{FLH_{cooling}} \right) * CF$$

Where:

$FLH_{cooling}$ = Full load hours of air conditioning based on climate zone.
 = Dependent on location:¹⁷¹¹

Climate Zone (City based upon)	Single Family	Multifamily
1 (Rockford)	547	499
2 (Chicago)	709	629
3 (Springfield)	779	707
4 (Belleville)	1,082	982
5 (Marion)	956	868
Weighted Average ¹⁷¹²		
ComEd	676	603
Ameren	875	791
Statewide	731	655

Use Multifamily if: Building meets utility’s definition for multifamily and HVAC system serves single unit. For residential sized systems serving 2 or more units, assume single family hours.

CF_{SSP} = Summer System Peak Coincidence Factor for Central A/C (during utility peak hour)
 = 68%¹⁷¹³

$CF_{SSP, SF}$ = Summer System Peak Coincidence Factor for Heat Pumps in single-family homes (during system peak hour)
 = 72%¹⁷¹⁴

$CF_{SSP, MF}$ = Summer System Peak Coincidence Factor for Heat Pumps in multi-family homes (during system peak hour)

calculation based on the certified values for fuel energy (Ef in MMBtu/yr) and Eae (kWh/yr). An average of a 300 record sample (non-random) out of 1495 was 3.14%. This is, appropriately, ~50% greater than the ENERGY STAR version 3 criteria for 2% Fe. See “Programmable Thermostats Furnace Fan Analysis.xlsx” for reference.

¹⁷¹¹ Full load hours for Chicago, Moline and Rockford are provided in “Final Evaluation Report: Central Air Conditioning Efficiency Services (CACES), 2010, Navigant Consulting”, p.33. An average FLH/Cooling Degree Day (from NCDG) ratio was calculated for these locations and applied to the CDD of the other locations in order to estimate FLH. There is a county mapping table in Volume 1, Section 3.7 providing the appropriate city to use for each county of Illinois. During update cycle for version v.12, applied percent change of CDD65, NCEI Annual Normals from 30 yr data set (1981-2010) to more recent 15 yr data (2006-2020) to all FLHcool values.

¹⁷¹² Weighting for Ameren is based on electric accounts in each of the cooling zones. Weighting for ComEd and Statewide average is based on number of occupied residential housing units in each zone. ComEd is weighted average of Zones 1-2. Alternative program-weighted assumptions can be used if appropriate.

¹⁷¹³ Based on metering of 24 homes with central AC during PY4 and PY5 in Ameren Illinois service territory.

¹⁷¹⁴ Based on analysis of metering results from 24 heat pumps in Ameren Illinois service territory in PY5 coincident with AIC’s 2010 system peak; ‘Impact and Process Evaluation of Ameren Illinois Company’s Residential HVAC Program (PY5)’.

- $= 67\%^{1715}$
- CF_{PJM} = PJM Summer Peak Coincidence Factor for Central A/C (average during PJM peak period)
 $= 46.6\%^{1716}$
- CF_{PJM, SF} = PJM Summer Peak Coincidence Factor for Heat Pumps in single-family homes (average during PJM peak period)
 $= 46.6\%^{1717}$
- CF_{PJM, MF} = PJM Summer Peak Coincidence Factor for Heat Pumps in multi-family homes (average during peak period)
 $= 28.5\%$

FOSSIL FUEL SAVINGS

$$\Delta Therms = GHS_{cz} * Area_{window}$$

Where:

GHS_{cz} = Annual fossil fuel heating savings per area of window by climate zone, see table below

Heating savings per window area by climate zone and baseline window condition¹⁷¹⁸

Climate Zone	Single Pane Base Window (therms/ft ²)	Double Pane Base Window (therms/ft ²)
1 - Rockford	0.80	0.09
2 - Chicago	0.76	0.09
3 - Springfield	0.65	0.07
4 - Belleville	0.50	0.06
5 - Marion	0.51	0.06

Area_{window} = Total area of installed window inserts. Use site specific value.

¹⁷¹⁵ Multifamily coincidence factors both from; *All-Electric Homes PY6 Metering Results: Multifamily HVAC Systems*, Cadmus, October 2015

¹⁷¹⁶ Based on analysis of Itron eShape data for Missouri, calibrated to Illinois loads, supplied by Ameren. The average AC load over the PJM peak period (1-5pm, M-F, June through August) is divided by the maximum AC load during the year.

¹⁷¹⁷ Based on analysis of Itron eShape data for Missouri, calibrated to Illinois loads, supplied by Ameren. The average AC load over the PJM peak period (1-5pm, M-F, June through August) is divided by the maximum AC load during the year.

¹⁷¹⁸ Based on savings modeled by EPA, “ES Storm Windows RESFEN Data and Calculations.xlsx”, April 2017. Whole House Heating energy values from the “Raw Data-Exterior Storm Windows” and “Raw Data-Interior Storm Windows,” Climate Zone 5, Location IL Chicago, wood frame, single pane, exterior low-E (0.148 panel) and interior low-E (0.148 panel) were used to calculate savings. EPA only reported single pane modeling results. In order to estimate impacts for double pane windows, ratios of double pane to single pane cooling energy was applied as reported by the Pacific Northwest National Laboratory for the U.S. Department of Energy, “Task ET-WIN-PNNL-FY13-01-5.3: Database of Low-e Storm Window Energy Performance across U.S. Climate Zones,” September 2013. Values from Appendix C, table C.8 for Chicago, Illinois were used to calculate the ratio of double pane to single pane heating energy. See “Low E Window Workpaper Supporting Calculations.xlsx” for reference.

For example, a single family gas heated residence in Rockford installs 10 window inserts over single pane windows. Each window is 12 square feet for a total window area of 120 square feet.

$$\Delta Therms = 0.80 * 120 = 95.81 \text{ therms}$$

$$\Delta kWh = 0.46 * 120 + 95.81 * 0.0314 * 29.3 = 143.37 \text{ kWh}$$

$$\Delta kW_{PJM} = \left(\frac{143.37}{547} \right) * 0.466 = 0.12 \text{ kW}$$

WATER AND OTHER NON-ENERGY IMPACT DESCRIPTIONS AND CALCULATION

N/A

DEEMED O&M COST ADJUSTMENT CALCULATION

N/A

MEASURE CODE: RS-SHL-LESW-V04-250101

REVIEW DEADLINE: 1/1/2028

5.6.8 High Performance Windows

DESCRIPTION

High Performance Windows (HPWs) greatly improve building thermal envelope performance compared to code standard double-glazed windows. HPWs must achieve a U-value ≤ 0.22 for the Northern climate zone,¹⁷¹⁹ or ≤ 0.25 for the North-Central climate zone. High performance windows significantly decrease heat loss through a building’s envelope in a number of ways: by adding one or more additional panes of glass in the insulating glass unit (IGU), applying additional coatings to the glass panes, adding new gas fill, and/or using thermally improved spacers.

HPWs’ reduced heat transfer significantly effects home energy savings as windows are often the weakest part of any building envelope. In addition to reducing heat transfer, HPWs also reduce air infiltration, thereby contributing to decreased HVAC loads. HPWs provide benefits for both heating and cooling seasons, and for both natural gas- and electrically-heated and cooled homes. They also have non-energy benefits such as increased thermal comfort and decreased outside noise.

This measure was developed for the following program types: New Construction (NC), Time of Sale (TOS), and Early Replacement (EREP). If applied to other program types, the measure savings should be verified.

By default, any “standard” window replacement (i.e. replacing an existing window of the same size with no structural changes to building) should be considered TOS/EREP for savings purposes unless the local code is explicitly triggered, in which case NC savings values shall be used.¹⁷²⁰

DEFINITION OF EFFICIENT EQUIPMENT

HPWs are windows that meet the ENERGY STAR® version 7.0 performance specifications shown below:

Table 1: Key Product Criteria for High Performance Windows¹⁷²¹

IL Degree-Day Zone	ENERGY STAR Climate Zone	U-Value	SHGC	Prescriptive or Performance-Based
1 – Rockford 2 – Chicago 3 – Springfield	Northern	≤ 0.22	≥ 0.17	Prescriptive
		$= 0.23$	≥ 0.35	Equivalent Energy Performance
		$= 0.24$		
		$= 0.25$	≥ 0.40	
		$= 0.26$		
4 – Belleville	North-Central	≤ 0.25	≤ 0.40	
5 – Marion				Prescriptive

HPWs can achieve these performance specifications in a number of ways. Some examples of HPWs include:

- Thin Triple Windows (TTW) – the insulating glass unit (IGU) contains three panes of glass. A thin pane of center glass allows the IGU to fit within a standard window frame, eliminating the need to redesign the window. The inclusion of a thin pane of center glass allows for an additional surface for low-E coating, reducing the window’s emissivity of thermal radiation and the rate of heat transfer by improving the U-value of the IGU and overall assembly. TTWs have two equal width panes of glass on the exterior and interior of the IGU and a thin center piece of glass that allows the IGU to fit within an existing double-pane

¹⁷¹⁹ In some cases, HPWs can have U-values of up to 0.26 in the Northern climate zone if the window meets alternative, performance-based SHGC thresholds. See **Error! Reference source not found.** for the specifications.

¹⁷²⁰ Preliminary analysis indicates an overwhelming majority of Illinois residents live in municipalities with code exemptions for windows being replaced for the same size/in the existing opening (e.g. Chicago does not require a building permit for “repairing or replacing (in-kind) an exterior window or skylight in the existing opening”. Link: <https://www.chicago.gov/city/en/sites/guide-to-building-permits/home/help/faq/DOB/bldg-permit-not-required/worktype/exterior.html>). Therefore the assumption is that code is not triggered until proven otherwise. For future TRM revisions, this assumption may be revisited.

¹⁷²¹ENERGY STAR® Version 7.0 Residential Windows, Doors, and Skylights Final Specification.

window frame.

- Triple Pane Windows – conventional triple pane windows that contain three panes of standard thickness glass. These windows provide an additional surface for a low-e coating and provide improved thermal performance by decreasing a window’s emissivity and improving the window’s resistance to heat loss. These windows are typically heavier than double-panes or TTWs and require a redesign of the window to allow the heavier, wider IGU to fit within the window frame.
- Double-pane windows that have low-e coatings on the two surfaces that face the cavity between the two panes of glass as well as on the interior-facing interior pane of glass, warm edge spacers, and improved frame thermal properties (e.g., adding foam or other insulation to the frame cavities).¹⁷²²

DEFINITION OF BASELINE EQUIPMENT

New Construction: The tables below show International Energy Conservation Code (IECC) 2018 and IECC 2021 window codes for new construction. For first permits dated November 1, 2022 or later in the city of Chicago, or January 1, 2024 for the remainder of Illinois, residential new construction must be built in accordance with IECC 2021.

Table 2: IECC – Fenestration Requirements^{1723,1724}

IL Degree-Day Zone	IECC Climate Zone	U-Value	SHGC
1 – Rockford	5	≤ 0.30	<i>Not Rated</i> ¹⁷²⁵ (IECC 2018) ≤ 0.40 (IECC 2021)
2 – Chicago			
3 – Springfield			
4 – Belleville	4	≤ 0.32 (IECC 2018)	<i>Not Rated</i> ¹⁷²⁶ (IECC 2018) ≤ 0.40 (IECC 2021)
5 – Marion		≤ 0.30 (IECC 2021)	

Time of Sale and Early Replacement in Existing Homes:

Table 3: Existing Homes – Existing Window Values: Double Pane¹⁷²⁷

IL Degree-Day Zone	U-Value	SHGC
1 – Rockford	0.55	0.63
2 – Chicago		
3 – Springfield		
4 – Belleville		
5 – Marion		

¹⁷²² Stephen Selkowitz Consultants. Study of High-Performance Windows Incremental Manufacturing Cost. Prepared for NEEA, Report #E23-336. January 3, 2023.

¹⁷²³ 2018 International Energy Conservation Code, Fifth Version: November 2021. TABLE R402.1.2.

<https://codes.iccsafe.org/content/IECC2018P5/chapter-4-re-residential-energy-efficiency>

¹⁷²⁴ 2021 International Energy Conservation Code, Second Version: September 2021. TABLE R402.1.2.

<https://codes.iccsafe.org/content/IECC2021P2/chapter-4-re-residential-energy-efficiency>

¹⁷²⁵ Value used in modeling: SHGC=0.30. Engineering judgement made during EnergyPlus modeling by Lili Yu and Robert Hart, Lawrence Berkeley National Laboratory, May 11, 2023.

¹⁷²⁶ Value used in modeling: SHGC=0.30. Engineering judgement made during EnergyPlus modeling by Lili Yu and Robert Hart, Lawrence Berkeley National Laboratory, May 11, 2023.

¹⁷²⁷ Engineering judgement made during EnergyPlus modeling by Lili Yu and Robert Hart, Lawrence Berkeley National Laboratory, “High Performance Windows - Illinois Modeled Savings Summary,” April 2021. Informed by air sealing and insulation research by Navigant, see Navigant (2018). ComEd and Nicor Gas Air Sealing and Insulation Research Report. Presented to Commonwealth Edison Company and Nicor Gas Company.

Table 4: Existing Homes – Existing Window Values: Single Pane¹⁷²⁸

IL Degree-Day Zone	U-Value	SHGC
1 – Rockford	1.0	0.76
2 – Chicago		
3 – Springfield		
4 – Belleville		
5 – Marion		

DEEMED LIFETIME OF EFFICIENT EQUIPMENT

The measure life is assumed to be 40 years.¹⁷²⁹

The remaining life of existing equipment is assumed to be 13 years.¹⁷³⁰

DEEMED MEASURE COST

The incremental cost for this measure depends on the program delivery type/baseline and climate zone.

New Construction (NC) and Time of Sale (TOS): includes only equipment cost above baseline:

IL Degree-Day Zone	ENERGY STAR Climate Zone	NC or TOS ¹⁷³¹
1 – Rockford 2 – Chicago 3 - Springfield	Northern	\$3.85/ft ²
4 – Belleville 5 – Marion	North-Central	\$2.18/ft ²

Early Replacement (EREP): Actual equipment and labor costs for installation, less the present value of the assumed deferred replacement cost, should be used. If this is unknown, assume the defaults below. The deferred cost (after 13 years) of replacing existing windows with a new code required double-pane baseline unit is assumed to be \$48.50 per square foot¹⁷³².

IL Degree-Day Zone	ENERGY STAR Climate Zone	EREP
1 – Rockford 2 – Chicago 3 - Springfield	Northern	\$52.35/ft ²
4 – Belleville 5 – Marion	North-Central	\$50.68/ft ²

LOADSHAPE

Loadshape R08 - Residential Cooling

¹⁷²⁸ Ibid

¹⁷²⁹ The Northwest Power Plan (NPCC). Please see sheet “Source Summary” within file: Com-Windows-2021P_V17.xlsx. Link: <https://nwcouncil.app.box.com/s/u0dgjxkoxoi2ttym81uka3wrjcy6bo6/file/655810989510>

¹⁷³⁰ Assumed to be one third of effective useful life. For future TRM versions, recommend RUL be informed from program research.

¹⁷³¹ Based on US EPA. ENERGY STAR® Windows, Doors, and Skylights Draft 1 Version 7 Stakeholder Webinar. July 27, 2021. https://www.energystar.gov/sites/default/files/asset/document/V7_Stakeholder%20Meeting_7-27-2021_final.pdf. Costs on slide 20 were averaged across both SHGC values as both can meet ENERGY STAR v.7 performance specifications. These costs assume a 3’x5’ (15ft²) window.

¹⁷³² \$37.82 inflated using 1.91% rate.

Loadshape R09 - Residential Electric Space Heat
 Loadshape R10 - Residential Electric Heating and Cooling

COINCIDENCE FACTOR

The summer peak coincidence factor for cooling is provided in two different ways below. The first is used to estimate peak savings during the utility peak hour and is most indicative of actual peak benefits, and the second represents the average savings over the defined summer peak period, and is presented so that savings can be bid into PJM’s Forward Capacity Market.

CF _{SSP}	= Summer System Peak Coincidence Factor for Central A/C (during utility peak hour) = 68% ¹⁷³³
CF _{SSP SF}	= Summer System Peak Coincidence Factor for Heat Pumps in single-family homes (during system peak hour) = 72% ¹⁷³⁴
CF _{SSP, MF}	= Summer System Peak Coincidence Factor for Heat Pumps in multi-family homes (during system peak hour) = 67% ¹⁷³⁵
CF _{PJM}	= PJM Summer Peak Coincidence Factor for Central A/C (average during PJM peak period) = 46.6% ¹⁷³⁶
CF _{PJM SF}	= PJM Summer Peak Coincidence Factor for Heat Pumps in single-family homes (average during PJM peak period) = 46.6% ¹⁷³⁷
CF _{PJM, MF}	= PJM Summer Peak Coincidence Factor for Heat Pumps in multi-family homes (average during peak period) = 28.5%

¹⁷³³ Based on metering of 24 homes with central AC during PY4 and PY5 in Ameren Illinois service territory.

¹⁷³⁴ Based on analysis of metering results from 24 heat pumps in Ameren Illinois service territory in PY5 coincident with AIC’s 2010 system peak; ‘Impact and Process Evaluation of Ameren Illinois Company’s Residential HVAC Program (PY5)’.

¹⁷³⁵ Multifamily coincidence factors both from; *All-Electric Homes PY6 Metering Results: Multifamily HVAC Systems*, Cadmus, October 2015

¹⁷³⁶ Based on analysis of Itron eShape data for Missouri, calibrated to Illinois loads, supplied by Ameren. The average AC load over the PJM peak period (1-5pm, M-F, June through August) is divided by the maximum AC load during the year.

¹⁷³⁷ Based on analysis of Itron eShape data for Missouri, calibrated to Illinois loads, supplied by Ameren. The average AC load over the PJM peak period (1-5pm, M-F, June through August) is divided by the maximum AC load during the year.

Algorithm

CALCULATION OF ENERGY SAVINGS

ELECTRIC ENERGY SAVINGS

$$\Delta kWh = \Delta kWh_{cooling} + \Delta kWh_{heating} + \Delta kWh_{fan}$$

$$\Delta kWh = CS_{cz} * Area_{window}$$

Where:

CS_{cz} = Annual heating, cooling + fan savings per area of window by climate zone, see Tables 5-7 below.

$Area_{window}$ = Total area of installed high performance windows. Use site specific value.

Table 5: Air Conditioner with Gas Furnace – electric savings per window area (kWh/ft²)¹⁷³⁸

IL Degree-Day Zone	NC (IECC 2018)	NC (IECC 2021)	TOS or EREP: Double Pane	EREP: Single Pane
1 – Rockford	0.58	0.60	1.22	2.33
2 – Chicago	0.60	0.61	1.20	2.24
3 – Springfield	0.51	0.69	1.39	2.70
4 – Belleville	0.53	0.78	1.39	2.74
5 – Marion	0.62	0.78	1.25	2.64

Table 6: Air Conditioner with Electric Resistance Heat – electric savings per window area (kWh/ft²)¹⁷³⁹

IL Degree-Day Zone	NC (IECC 2018)	NC (IECC 2021)	TOS or EREP: Double Pane	EREP: Single Pane
1 – Rockford	2.42	2.58	4.24	14.77
2 – Chicago	2.71	2.79	4.04	13.43
3 – Springfield	2.64	2.30	3.70	11.39
4 – Belleville	2.97	2.07	4.10	12.35
5 – Marion	2.16	1.86	3.95	9.88

Table 7: Heat Pump – electric savings per window area (kWh/ft²)¹⁷⁴⁰

IL Degree-Day Zone	NC (IECC 2018)	NC (IECC 2021)	TOS or EREP: Double Pane	EREP: Single Pane
1 – Rockford	1.73	1.52	7.62	19.68
2 – Chicago	1.53	1.69	6.95	17.14
3 – Springfield	1.92	1.24	6.24	15.01
4 – Belleville	1.76	1.37	6.36	14.98
5 – Marion	1.43	1.34	5.90	12.62

¹⁷³⁸ EnergyPlus modeling performed by Lili Yu and Robert Hart, “2023-07-26 LBNL Modeling_NC-TOS_TMYx.xlsx”, “ 2023-08-04 LBNL Modeling_EREP_TMYx_Double Pane”, “2023-08-30 LBNL Modeling_EREP_TMYx_Single Pane,” Lawrence Berkeley National Laboratory. May 11, 2023. Yu and Hart's energy modeling incorporated the most commonly commercially available windows that meet or exceed the energy performance criteria relevant to each climate zone (CZ). Specifically, the analysts derived energy savings using these specifications for HPWs: 1) Northern CZ, NC: U=0.30/SHGC=0.30; 2) Northern CZ, TOS/EREP: U=0.22/SHGC=0.25; 3) North-Central CZ, NC: U=0.22/SHGC=0.25; 4) North-Central CZ TOS/EREP: average of savings from U=0.25/SHGC=0.20 and U=0.25/SHGC=0.28.

¹⁷³⁹ Ibid

¹⁷⁴⁰ Ibid

SUMMER COINCIDENT PEAK DEMAND SAVINGS

$$\Delta kW = \left(\frac{\Delta kWh_{cooling}}{FLH_{cooling}} \right) * CF$$

Where:

$\Delta kWh_{cooling}$ = Annual cooling-only electricity savings, based on climate zone and equipment type. See Tables 9-11

$FL_{cooling}$ = Full load hours of air conditioning
 = dependent on location:¹⁷⁴¹

Climate Zone (City based upon)	Single Family	Multifamily
1 (Rockford)	547	499
2 (Chicago)	709	629
3 (Springfield)	779	707
4 (Belleville)	1082	982
5 (Marion)	956	868
Weighted Average ¹⁷⁴²		
ComEd	676	603
Ameren	875	791
Statewide	731	655

CF_{SSP} = Summer System Peak Coincidence Factor for Central A/C (during utility peak hour)
 = 68%¹⁷⁴³

$CF_{SSP, SF}$ = Summer System Peak Coincidence Factor for Heat Pumps in single-family homes (during system peak hour)
 = 72%¹⁷⁴⁴

$CF_{SSP, MF}$ = Summer System Peak Coincidence Factor for Heat Pumps in multi-family homes (during system peak hour)
 = 67%¹⁷⁴⁵

CF_{PJM} = PJM Summer Peak Coincidence Factor for Central A/C (average during PJM peak period)

¹⁷⁴¹ Full load hours for Chicago, Moline and Rockford are provided in “Final Evaluation Report: Central Air Conditioning Efficiency Services (CACES), 2010, Navigant Consulting”, p.33. An average FLH/Cooling Degree Day (from NCDC) ratio was calculated for these locations and applied to the CDD of the other locations in order to estimate FLH. There is a county mapping table in Volume 1, Section 3.7 providing the appropriate city to use for each county of Illinois. During update cycle for version v.12, applied percent change of CDD65, NCEI Annual Normals from 30 yr data set (1981-2010) to more recent 15 yr data (2006-2020) to all FLHcool values.

¹⁷⁴² Weighting for Ameren is based on electric accounts in each of the cooling zones. Weighting for ComEd and Statewide average is based on number of occupied residential housing units in each zone. ComEd is weighted average of Zones 1-2. Alternative program-weighted assumptions can be used if appropriate.

¹⁷⁴³ Based on metering of 24 homes with central AC during PY4 and PY5 in Ameren Illinois service territory.

¹⁷⁴⁴ Based on analysis of metering results from 24 heat pumps in Ameren Illinois service territory in PY5 coincident with AIC’s 2010 system peak; ‘Impact and Process Evaluation of Ameren Illinois Company’s Residential HVAC Program (PY5)’.

¹⁷⁴⁵ Multifamily coincidence factors both from; *All-Electric Homes PY6 Metering Results: Multifamily HVAC Systems*, Cadmus, October 2015

- = 46.6%¹⁷⁴⁶
- CF_{PJM, SF} = PJM Summer Peak Coincidence Factor for Heat Pumps in single-family homes (average during PJM peak period)
= 46.6%¹⁷⁴⁷
- CF_{PJM, MF} = PJM Summer Peak Coincidence Factor for Heat Pumps in multi-family homes (average during peak period)
= 28.5%

Table 9: Air Conditioner with Gas Furnace – cooling only electric savings per window area (kWh/ft²)¹⁷⁴⁸

IL Degree-Day Zone	NC (IECC 2018)	NC (IECC 2021)	TOS or EREP: Double Pane	EREP: Single Pane
1 – Rockford	0.35	0.35	0.60	1.24
2 – Chicago	0.35	0.36	0.53	1.13
3 – Springfield	0.39	0.44	0.61	1.37
4 – Belleville	0.40	0.56	0.60	1.38
5 – Marion	0.46	0.57	0.48	1.27

Table 10: Air Conditioner with Electric Resistance Heat – cooling only electric savings per window area (kWh/ft²)¹⁷⁴⁹

IL Degree-Day Zone	NC (IECC 2018)	NC (IECC 2021)	TOS or EREP: Double Pane	EREP: Single Pane
1 – Rockford	0.31	0.36	0.48	2.17
2 – Chicago	0.36	0.33	0.47	1.97
3 – Springfield	0.35	0.44	0.43	1.65
4 – Belleville	0.39	0.55	0.36	1.67
5 – Marion	0.44	0.56	0.36	1.31

Table 11: Heat Pump – cooling only electric savings per window area (kWh/ft²)¹⁷⁵⁰

IL Degree-Day Zone	NC (IECC 2018)	NC (IECC 2021)	TOS or EREP: Double Pane	EREP: Single Pane
1 – Rockford	0.31	0.34	0.56	2.27
2 – Chicago	0.35	0.32	0.58	2.04
3 – Springfield	0.34	0.36	0.50	1.78
4 – Belleville	0.39	0.55	0.41	1.67
5 – Marion	0.43	0.56	0.39	1.41

¹⁷⁴⁶ Based on analysis of Itron eShape data for Missouri, calibrated to Illinois loads, supplied by Ameren. The average AC load over the PJM peak period (1-5pm, M-F, June through August) is divided by the maximum AC load during the year.

¹⁷⁴⁷ Based on analysis of Itron eShape data for Missouri, calibrated to Illinois loads, supplied by Ameren. The average AC load over the PJM peak period (1-5pm, M-F, June through August) is divided by the maximum AC load during the year.

¹⁷⁴⁸ EnergyPlus modeling performed by Lili Yu and Robert Hart, “2023-07-26 LBNL Modeling_NC-TOS_TMYx.xlsx”, “2023-08-04 LBNL Modeling_EREP_TMYx_Double Pane”, “2023-08-30 LBNL Modeling_EREP_TMYx_Single Pane,” Lawrence Berkeley National Laboratory. May 11, 2023. Yu and Hart's energy modeling incorporated the most commonly commercially available windows that meet or exceed the energy performance criteria relevant to each climate zone (CZ). Specifically, the analysts derived energy savings using these specifications for HPWs: 1) Northern CZ, NC: U=0.30/SHGC=0.30; 2) Northern CZ, TOS/EREP: U=0.22/SHGC=0.25; 3) North-Central CZ, NC: U=0.22/SHGC=0.25; 4) North-Central CZ TOS/EREP: average of savings from U=0.25/SHGC=0.20 and U=0.25/SHGC=0.28.

¹⁷⁴⁹ Ibid

¹⁷⁵⁰ Ibid

FOSSIL FUEL SAVINGS

$$\Delta Therms = HS_{cz} * Area_{window}$$

Where:

- HS_{cz} = Annual heating savings per area of window by climate zone, see Table 12.
- $Area_{window}$ = Total area of installed high performance windows. Use site specific value.

Table 12: Gas heating savings per window area by climate zone and baseline window condition (therm/ft²)¹⁷⁵¹

IL Degree-Day Zone	NC (IECC2018)	NC (IECC 2021)	TOS or EREP: Double Pane	TOS or EREP: Single Pane
1 – Rockford	0.12	0.09	0.22	1.27
2 – Chicago	0.09	0.12	0.21	1.12
3 – Springfield	0.16	0.08	0.17	0.91
4 – Belleville	0.17	0.07	0.16	0.89
5 – Marion	0.14	0.06	0.16	0.73

For example, a single family residence in Rockford with a gas furnace and air conditioner replaces 10 existing double pane windows with HPW. Each window is 12 square feet, so the total window area is 120 square feet.

1st 13 years savings calculation:

$$\Delta Therms = 0.22 * 120 = 26.4 \text{ therms}$$

$$\Delta kWh = 1.22 * 120 = 146.4 \text{ kWh}$$

$$\Delta kW_{PJM} = \left(\frac{146.4}{512} \right) * 0.466 = 0.13 \text{ kW}$$

Remaining 27 years savings calculation:

$$\Delta Therms = 0.12 * 120 = 14.4 \text{ therms}$$

$$\Delta kWh = 0.58 * 120 = 69.6 \text{ kWh}$$

$$\Delta kW_{PJM} = \left(\frac{69.6}{512} \right) * 0.466 = 0.063 \text{ kW}$$

WATER IMPACT DESCRIPTIONS AND CALCULATION

N/A

¹⁷⁵¹ EnergyPlus modeling performed by Lili Yu and Robert Hart, “2023-07-26 LBNL Modeling_NC-TOS_TMYx.xlsx”, “ 2023-08-04 LBNL Modeling_EREP_TMYx_Double Pane”, “2023-08-30 LBNL Modeling_EREP_TMYx_Single Pane,” Lawrence Berkeley National Laboratory. May 11, 2023. Yu and Hart’s energy modeling incorporated the most commonly commercially available windows that meet or exceed the energy performance criteria relevant to each climate zone (CZ). Specifically, the analysts derived energy savings using these specifications for HPWs: 1) Northern CZ, NC: U=0.30/SHGC=0.30; 2) Northern CZ, TOS/EREP: U=0.22/SHGC=0.25; 3) North-Central CZ, NC: U=0.22/SHGC=0.25; 4) North-Central CZ TOS/EREP: average of savings from U=0.25/SHGC=0.20 and U=0.25/SHGC=0.28.

DEEMED O&M COST ADJUSTMENT CALCULATION

N/A

MEASURE CODE: RS-SHL-TTWI-V05-250101

REVIEW DEADLINE: 1/1/2028

5.6.9 Insulated Cellular Shades

DESCRIPTION

Insulating cellular shades greatly improve the thermal envelope performance compared to uncovered windows or conventional vinyl window coverings. These coverings have a honeycomb or cellular structure that can be operated manually or automated. Insulated cellular shades are considered to have the highest R-value among available blinds, shades, and other window coverings. They are designed with multiple layers of varying fabrics to trap air inside pockets that act as insulators and increase the R-value of the window covering and reduce the thermal heat transfer through windows.

The window's reduced heat loss has a significant impact on home energy savings as windows are often the weakest part of any building envelope. These products provide benefits for both heating and cooling seasons and for both natural gas and electric heated and cooled homes. They also have non-energy benefits such as, increased thermal comfort and decreased outside noise.

This measure was developed to be applicable to the following program types: TOS, NC. If applied to other program types, the measure savings should be verified

DEFINITION OF EFFICIENT EQUIPMENT

The efficient insulating cellular shades must be at least a double cell design installed on at least 75% of a home's windows. The Attachments Energy Rating Council (AERC) has a third party verified rating that has been developed for residential window attachments¹⁷⁵². If possible, utilizing the AERC rating system, eligible insulating cellular shades need to have a Cool Climate Rating greater or equal to 10 due to the Illinois climate.

DEFINITION OF BASELINE EQUIPMENT

The baseline for this measure is a home with uncovered windows or standard existing shades or blinds.

DEEMED LIFETIME OF EFFICIENT EQUIPMENT

The measure life is assumed to be 10 years.

DEEMED MEASURE COST

The costs of window coverings vary greatly based on factors other than energy efficiency. The incremental cost of insulated cellular shades over standard window coverings is assumed to be \$40 per shade or \$600 per home.

LOADSHAPE

- Loadshape R08 - Residential Cooling
- Loadshape R09 - Residential Electric Space Heat
- Loadshape R10 - Residential Electric Heating and Cooling

COINCIDENCE FACTOR

- CF_{SSP} = Summer System Peak Coincidence Factor for Central A/C (during utility peak hour)
= 68%¹⁷⁵³
- CF_{SSP SF} = Summer System Peak Coincidence Factor for Heat Pumps in single-family homes (during system peak hour)

¹⁷⁵² Attachments Energy Rating Council. May 01, 2022. [www.https://aercenergyrating.org/](https://aercenergyrating.org/)

¹⁷⁵³ Based on metering of 24 homes with central AC during PY4 and PY5 in Ameren Illinois service territory.

	= 72% ¹⁷⁵⁴
CF _{SSP, MF}	= Summer System Peak Coincidence Factor for Heat Pumps in multi-family homes (during system peak hour) = 67% ¹⁷⁵⁵
CF _{PJM}	= PJM Summer Peak Coincidence Factor for Central A/C (average during PJM peak period) = 46.6% ¹⁷⁵⁶
CF _{PJM SF}	= PJM Summer Peak Coincidence Factor for Heat Pumps in single-family homes (average during PJM peak period) = 46.6% ¹⁷⁵⁷
CF _{PJM, MF}	= PJM Summer Peak Coincidence Factor for Heat Pumps in multi-family homes (average during peak period) = 28.5%

Algorithm

CALCULATION OF ENERGY SAVINGS

ELECTRIC ENERGY SAVINGS

$$\Delta kWh = (\Delta kWh_{cooling} + \Delta kWh_{heatingElectric} + \Delta kWh_{heatingFurnace})$$

Where:

$\Delta kWh_{cooling}$ = If central cooling, reduction in annual cooling requirement due to cellular window shades
= $FLH_{cool} * Capacity_{cooling} * ((1/SEER2)/1000) * ESF_{cool}$

FLH_{cool} = Full load cooling hours

= Dependent on location as below:¹⁷⁵⁸

Climate Zone (City based upon)	Single Family	Multifamily
1 (Rockford)	547	499
2 (Chicago)	709	629

¹⁷⁵⁴ Based on analysis of metering results from 24 heat pumps in Ameren Illinois service territory in PY5 coincident with AIC’s 2010 system peak; ‘Impact and Process Evaluation of Ameren Illinois Company’s Residential HVAC Program (PY5)’.

¹⁷⁵⁵ Multifamily coincidence factors both from; *All-Electric Homes PY6 Metering Results: Multifamily HVAC Systems*, Cadmus, October 2015

¹⁷⁵⁶ Based on analysis of Itron eShape data for Missouri, calibrated to Illinois loads, supplied by Ameren. The average AC load over the PJM peak period (1-5pm, M-F, June through August) is divided by the maximum AC load during the year.

¹⁷⁵⁷ Based on analysis of Itron eShape data for Missouri, calibrated to Illinois loads, supplied by Ameren. The average AC load over the PJM peak period (1-5pm, M-F, June through August) is divided by the maximum AC load during the year.

¹⁷⁵⁸ Full load hours for Chicago, Moline and Rockford are provided in “Final Evaluation Report: Central Air Conditioning Efficiency Services (CACES), 2010, Navigant Consulting”, p.33. An average FLH/Cooling Degree Day (from NCEI) ratio was calculated for these locations and applied to the CDD of the other locations in order to estimate FLH. There is a county mapping table in Volume 1, Section 3.7 providing the appropriate city to use for each county of Illinois. During update cycle for version v.12, applied percent change of CDD65, NCEI Annual Normals from 30 yr data set (1981-2010) to more recent 15 yr data (2006-2020) to all FLHcool values.

Climate Zone (City based upon)	Single Family	Multifamily
3 (Springfield)	779	707
4 (Belleville)	1082	982
5 (Marion)	956	868
Weighted Average ¹⁷⁵⁹		
ComEd	676	603
Ameren	875	791
Statewide	731	655

Use Multifamily if: Building meets utility’s definition for multifamily and HVAC system serves single unit. For residential sized systems serving 2 or more units, assume single family hours.

Capacity_cooling = Size of new equipment in Btu/hr (note 1 ton = 12,000Btu/hr)

= Use actual when program delivery allows size of AC unit to be known. If unknown, assume 33,600 Btu/hr for single family homes, 28,000 Btu/hr for multifamily, or 24,000 Btu/hr for mobile homes.¹⁷⁶⁰ If building type is unknown, assume 31,864Btu/hr.¹⁷⁶¹

SEER2

= the cooling equipment’s Seasonal Energy Efficiency Ratio rating (kBtu/kWh)

= Use actual SEER2 rating where it is possible to measure or reasonably estimate. If using rated efficiencies, derate efficiency value by 1% per year (maximum of 30 years) to account for degradation over time¹⁷⁶². If unknown, use the following assumption (do not derate further by age):

Cooling System	SEER2 ¹⁷⁶³
Air Source Heat Pump	11.4
Central AC	

ESF_{cool}

= Insulating cellular shades cooling energy savings factor
= 0.05¹⁷⁶⁴

$\Delta kWh_{\text{Heating Electric}}$ = If electric heat (resistance or heat pump), reduction in annual electric heating due to cellular window shades

$$= FLH_{\text{heat}} * Capacity_{\text{heating}} * ((1/HSPF2_{\text{ASHP}})/1000) * ESF_{\text{heat}}$$

¹⁷⁵⁹ Weighting for Ameren is based on electric accounts in each of the cooling zones. Weighting for ComEd and Statewide average is based on number of occupied residential housing units in each zone. ComEd is weighted average of Zones 1-2. Alternative program-weighted assumptions can be used if appropriate.

¹⁷⁶⁰ Single family cooling capacity based on Final Evaluation Report: Central Air Conditioning Efficiency Services (CACES), October 19, 2010, ComEd, Navigant Consulting. Multifamily capacity based on weighted average of PY9 Ameren and ComEd MF cooling capacities. Mobile home capacity based on ENERGY STAR’s Manufactured Home Cooling Equipment Sizing Guidelines which vary by climate zone and home size. The average size of a mobile home in the East North Central region (1,120 square feet) from the 2015 RECS data is used to calculate appropriate size.

¹⁷⁶¹ Unknown is based on statewide weighted average of 69% single family and 31% multifamily, based on IL data from 2009 RECS Table HC2.9 Structural and Geographic Characteristics of Homes in Midwest Region, Divisions and States, 2009.

¹⁷⁶² Justification for degradation factors can be found on page 14 of ‘AIC HVAC Metering Study Memo FINAL 2_28_2018’. Estimate efficiency as (Rated Efficiency * (1-0.01)^{Equipment Age}).

¹⁷⁶³ Estimate based upon Navigant, 2018 “EIA – Technology Forecast Updates – Residential and Commercial Building Technologies – Reference Case”, converted to SEER2.

¹⁷⁶⁴ Average of HVAC savings for typical use compared to baseline conditions of no shades and common vinyl blinds. “Testing the Performance and Dynamic Control of Energy-Efficient Cellular Shades in the PNNL Lab Homes.” PNNL. August 2018. Table 4.3 <https://aercnet.org/wp-content/uploads/2018/10/Testing-the-Performance-and-Dynamic-Control-of-Energy-Efficient-Cellular-Shades-in-the-PNNL-Lab-Homes.pdf>.

FLH_{heat} = Full load heating hours
 = Dependent on location as below:¹⁷⁶⁵

Climate Zone (City based upon)	FLH _{heat}
1 (Rockford)	1924
2 (Chicago)	1726
3 (Springfield)	1708
4 (Belleville)	1195
5 (Marion/Murphysboro)	1270
Weighted Average ¹⁷⁶⁶	
ComEd	1766
Ameren	1547
Statewide	1700

Capacity_{heating} = Heating output capacity (Btu/hr) of electric heat
 = Actual

HSPF_{2ASHP} = Heating Seasonal Performance Factor of efficient Air Source Heat Pump (kBtu/kWh)
 = Actual or 7.2 if unknown¹⁷⁶⁷

ESF_{heat} = Insulating cellular shades heating energy savings factor
 = 0.02¹⁷⁶⁸

ΔkWh_{Heating Furnace} = If fossil fuel heat, kWh savings for reduction in furnace fan run time
 = ΔTherms * F_e * 29.3

ΔTherms = (CAP_{InputPre} * EFLH * (1/ Eff)*ESF_{heat}) / 100,000

CAP_{InputPre} = Gas Furnace input capacity (Btuh)
 = Actual. If unknown, use the table below:

Eligibility Tier	Input Capacity ¹⁷⁶⁹
AFUE ≥ 95 (all furnaces, no tiers)	84,305

¹⁷⁶⁵ Heating EFLH based on ENERGY STAR EFLH for Rockford, Chicago, and Springfield and on NCDC/NOAA HDD for the other two cities. In all cases, the hours were adjusted based on average natural gas heating consumption in IL. During update cycle for version v.12, applied percent change of HDD60, NCEI Annual Normals from 30 yr data set (1981-2010) to more recent 15 yr data (2006-2020) to all FLH_{heat} values

¹⁷⁶⁶ Weighting for Ameren is based on electric heat accounts in each of the heating zones. Weighting for ComEd and Statewide average is based on number of occupied residential housing units in each zone. ComEd is weighted average of Zones 1-2. Alternative program-weighted assumptions can be used if appropriate.

¹⁷⁶⁷ ENERGY STAR minimum, converted to HSPF2.

¹⁷⁶⁸ "Testing the Performance and Dynamic Control of Energy-Efficient Cellular Shades in the PNNL Lab Homes." PNNL. August 2018. <https://aercnet.org/wp-content/uploads/2018/10/Testing-the-Performance-and-Dynamic-Control-of-Energy-Efficient-Cellular-Shades-in-the-PNNL-Lab-Homes.pdf>.

¹⁷⁶⁹ Average Input Capacity for Northern Illinois, based on analysis of Nicor Gas 2019 Home Energy Efficiency Rebate Program participant tracking data, prepared by Guidehouse, Inc., based on 12,549 furnaces rebated at the 95 AFUE Tier, and 1,103 furnaces rebated at the 97 AFUE Tier. Approximately 10% of tracked input capacities were adjusted by Guidehouse based on verification of manufacturer model numbers. Values for Southern Illinois not available.

EFLH = Equivalent Full Load Hours for heating¹⁷⁷⁰

Climate Zone (City based upon)	EFLH ⁵³⁴
1 (Rockford)	998
2 (Chicago)	915
3 (Springfield)	814
4 (Belleville)	609
5 (Marion)	647
Weighted Average ¹⁷⁷¹	
ComEd	932
Ameren	800
Statewide	883

Eff = Efficiency of furnace
 = Actual. If unknown, use 72% for existing system efficiency.¹⁷⁷²

F_e = Furnace Fan energy consumption as a percentage of annual fuel consumption
 = 3.14%¹⁷⁷³

29.3 = kWh per therm

SUMMER COINCIDENT PEAK DEMAND SAVINGS

$$\Delta kW = \text{Capacity}_{\text{cooling}} * ((1/\text{EER2})/1000) * \text{ESF}_d * \text{CF}$$

Where:

EER2 = Energy Efficiency Ratio of existing cooling system (kBtu/hr / kW)
 = Use actual EER (converted to EER2) rating where it is possible to measure or reasonably estimate. If EER2 unknown but SEER2 available convert using the equation:

$$\text{EER2} = (-0.02 * \text{SEER2}_{\text{exist}}^2) + (1.12 * \text{SEER2}_{\text{exist}})^{1774}$$

If SEER2 or EER2 rating unavailable, use:

Cooling System	EER2 ¹⁷⁷⁵
Air Source Heat Pump	10.0

¹⁷⁷⁰ Heating EFLH based on ENERGY STAR EFLH for Rockford, Chicago, and Springfield and on NCDC/NOAA HDD for the other two cities. In all cases, the hours were adjusted based on average natural gas heating consumption in IL. During update cycle for version v.12, applied percent change of HDD60, NCEI Annual Normals from 30 yr data set (1981-2010) to more recent 15 yr data (2006-2020) to all FLHheat values

¹⁷⁷¹ Weighting for Ameren is based on gas accounts in each of the heating zones. Weighting for ComEd and Statewide average is based on number of occupied residential housing units in each zone. ComEd is weighted average of Zones 1-2. Alternative program-weighted assumptions can be used if appropriate.

¹⁷⁷² Based on average Nicor PY4 nameplate efficiencies derated by 15% for distribution losses.

¹⁷⁷³ F_e is not one of the AHRI certified ratings provided for residential furnaces, but can be reasonably estimated from a calculation based on the certified values for fuel energy (Ef in MMBtu/yr) and Eae (kWh/yr). An average of a 300 record sample (non-random) out of 1495 was 3.14%. This is, appropriately, ~50% greater than the ENERGY STAR version 3 criteria for 2% F_e. See "Programmable Thermostats Furnace Fan Analysis.xlsx" for reference.

¹⁷⁷⁴ From Wassmer, M. (2003). A Component-Based Model for Residential Air Conditioner and Heat Pump Energy Calculations. Masters Thesis, University of Colorado at Boulder.

¹⁷⁷⁵ Based on converting SEER2 assumption to EER2.

Cooling System	EER2 ¹⁷⁷⁵
Central AC	

- ESF_d = Insulating cellular shades heating energy savings factor
= 0.02¹⁷⁷⁶
- CF_{SSP} = Summer System Peak Coincidence Factor for Central A/C (during utility peak hour)
= 68%¹⁷⁷⁷
- CF_{SSP SF} = Summer System Peak Coincidence Factor for Heat Pumps in single-family homes (during system peak hour)
= 72%¹⁷⁷⁸
- CF_{SSP, MF} = Summer System Peak Coincidence Factor for Heat Pumps in multi-family homes (during system peak hour)
= 67%¹⁷⁷⁹
- CF_{PJM} = PJM Summer Peak Coincidence Factor for Central A/C (average during PJM peak period)
= 46.6%¹⁷⁸⁰
- CF_{PJM SF} = PJM Summer Peak Coincidence Factor for Heat Pumps in single-family homes (average during PJM peak period)
= 46.6%¹⁷⁸¹
- CF_{PJM, MF} = PJM Summer Peak Coincidence Factor for Heat Pumps in multi-family homes (average during peak period)
= 28.5%

WATER AND OTHER NON-ENERGY IMPACT DESCRIPTIONS AND CALCULATION

N/A

DEEMED O&M COST ADJUSTMENT CALCULATION

N/A

¹⁷⁷⁶ “Testing the Performance and Dynamic Control of Energy-Efficient Cellular Shades in the PNNL Lab Homes.” PNNL. August 2018. <https://aercnet.org/wp-content/uploads/2018/10/Testing-the-Performance-and-Dynamic-Control-of-Energy-Efficient-Cellular-Shades-in-the-PNNL-Lab-Homes.pdf>.

¹⁷⁷⁷ Based on metering of 24 homes with central AC during PY4 and PY5 in Ameren Illinois service territory.

¹⁷⁷⁸ Based on analysis of metering results from 24 heat pumps in Ameren Illinois service territory in PY5 coincident with AIC’s 2010 system peak; ‘Impact and Process Evaluation of Ameren Illinois Company’s Residential HVAC Program (PY5)’.

¹⁷⁷⁹ Multifamily coincidence factors both from; *All-Electric Homes PY6 Metering Results: Multifamily HVAC Systems*, Cadmus, October 2015

¹⁷⁸⁰ Based on analysis of Itron eShape data for Missouri, calibrated to Illinois loads, supplied by Ameren. The average AC load over the PJM peak period (1-5pm, M-F, June through August) is divided by the maximum AC load during the year.

¹⁷⁸¹ Based on analysis of Itron eShape data for Missouri, calibrated to Illinois loads, supplied by Ameren. The average AC load over the PJM peak period (1-5pm, M-F, June through August) is divided by the maximum AC load during the year.

MEASURE CODE: RS-SHL-INCS-V03-250101

REVIEW DEADLINE: 1/1/2026

5.6.10 Multifamily Whole Building Aerosol Sealing

DESCRIPTION

Multifamily buildings have many of the same leakage paths as single-family homes, as well as additional paths hidden in shared walls or other cavities that are difficult to seal with conventional methods. Typically, shared walls between multifamily homes are difficult to air seal effectively, leading to issues when trying to meet code. This measure is the application of an aerosol sealant to a new or existing multifamily building. The aerosol envelope sealing technology uses an automated approach to produce extremely tight envelopes.

Air is blown into a multifamily unit while an aerosol sealant “fog” is released in the interior. As air escapes the building through leaks in the envelope, the sealant particles are carried to the leaks where they impact and stick to the edges of the leaks, eventually sealing them. A standard house or duct air leakage test fan is used to pressurize the building and provide real-time feedback and a permanent record of the sealing. The process is more effective and convenient than conventional sealing methods because it requires less time and effort, it can seal a larger portion of a leakage area more quickly, and can be used to meet more stringent compartmentalization requirements. It can be used to seal multiple units in a residential multi-family building in a cost-effective manner. Energy savings are estimated using EnergyPlus whole-building energy simulations.

This measure was developed to be applicable to the following program types: RF and NC. If applied to other program types, the measure savings should be verified.

DEFINITION OF EFFICIENT EQUIPMENT

Existing multifamily units which have been aerosol sealed that meet an air exchange rate of 3.0 ACH50 (air changes per hour) or lower. This meets the residential energy code tightness requirements¹⁷⁸². New multifamily units which have been aerosol sealed that meet an air exchange rate of 0.6 ACH50 (air changes per hour) or lower. This meets the Passive House tightness requirements.¹⁷⁸³

DEFINITION OF BASELINE EQUIPMENT

Existing multifamily buildings that are undergoing a major envelope retrofit. The existing air leakage should be determined through approved and appropriate test methods using a blower door at 50 Pascals. Note that setting up a blower door is a required step in the aerosol sealing process.

The baseline for new construction buildings would be the applicable code for air exchange rate.

DEEMED LIFETIME OF EFFICIENT EQUIPMENT

The expected measure life is assumed to be 20 years.¹⁷⁸⁴

DEEMED MEASURE COST

The measure cost for this aerosol sealing technology is \$0.50/sq.ft. of home size¹⁷⁸⁵.

LOADSHAPE

Loadshape R09 - Residential Electric Space Heat

Loadshape R10 - Residential Electric Heating and Cooling

¹⁷⁸² ICC. 2018 International Energy Conservation Code, International Code Council, Inc
 ICC. 2018 International Residential Code, International Code Council, Inc.

¹⁷⁸³ PHI (Passive House Institute). 2016. Passive House requirements (http://passiv.de/en/02_informations/02_passive-house-requirements/02_passive-house-requirements.htm). Information accessed on April 2022

¹⁷⁸⁴ Center for Energy and Environment. Demonstrating the Effectiveness of an Aerosol Sealant to Reduce Multi-Unit Dwelling Envelope Air Leakage. December 30, 2016. <http://mn.gov/commerce-stat/pdfs/card-cee-aerosol.pdf#page=47&zoom=100,0,404>

¹⁷⁸⁵ Ibid

COINCIDENCE FACTOR

N/A

Algorithm

CALCULATION OF ENERGY SAVINGS

Energy savings are estimated using EnergyPlus whole-building energy simulations.

It is important to note that the energy savings for multifamily whole-building sealing process cannot be estimated using a simple infiltration algorithm. This is because conversion of the measured building leakage (ACH50) to infiltration at natural conditions treats the entire building as a single zone and does not account for air movement between zones and housing units and also does not consider effects of mechanical ventilation. Therefore, whole building level energy modeling must be done to estimate energy savings.

Baseline and efficient energy models were developed in the referenced study for Minneapolis climate zone.¹⁷⁸⁶ The energy savings in this measure have been adjusted for the Illinois climate zones based on degree days.¹⁷⁸⁷ A multifamily building with six floors was modeled containing four housing units in each floor. Each modeled unit is 30 ft wide and 40 ft long with a floor area of 1,200 ft². The floor plan is the same for each of the six floors in the modeled building and is symmetric to minimize the effects of building orientation on the simulation results.

The heating system consists of a central boiler that served each apartment through terminal units. The boiler system is rated for 75% seasonal efficiency. Cooling is provided by window air conditioners. The independent variables include the building’s physical characteristics and operating parameters of the ventilation systems. The dependent variables include building energy use, total outside air flow (e.g. infiltration and ventilation), and inter-zonal air flows (e.g. adjoining units and units to/from common spaces).

ELECTRIC ENERGY SAVINGS

There is minimal impact on the cooling energy savings.¹⁷⁸⁸ There is a slight increase in the cooling energy needed after sealing due to less infiltration to offset internal loads. Due to the relatively small impact on cooling, it is not considered to be significant.

SUMMER COINCIDENT PEAK DEMAND SAVINGS

N/A

FOSSIL FUEL SAVINGS

The natural gas space heating savings are dependent on the ventilation system and whether the multifamily unit is existing or new construction.

Four types of continuous ventilation schemes were modeled for the apartments.

- a) Exhaust Only: Exhaust fan in each unit with no direct supply of outdoor air. Consists of a single fan connected to a centrally located, single exhaust point in the house.
- b) Exhaust and Half Supply: Ventilation scheme having both exhaust and supply ventilation systems. Full capacity exhaust fan in each unit with supply ventilation to the unit that is approximately half the exhaust capacity.
- c) Balanced: A balanced ventilation system that has two fans and two duct systems. They introduce and exhaust approximately equal quantities of fresh outside air and polluted inside air.
- d) No Ventilation: No continuous or intermittent mechanical ventilation. This is the most common type of

¹⁷⁸⁶ Center for Energy and Environment. Demonstrating the Effectiveness of an Aerosol Sealant to Reduce Multi-Unit Dwelling Envelope Air Leakage. December 30, 2016. <http://mn.gov/commerce-stat/pdfs/card-cee-aerosol.pdf#page=47&zoom=100,0,404>

¹⁷⁸⁷ “Whole Home Sealing HDD Adjustment Spreadsheet.xlsx”

¹⁷⁸⁸ “Whole Home Sealing HDD Adjustment Spreadsheet.xlsx”. The cooling savings penalties are extremely small in the order of 1-3% of the heating savings and have been excluded from this analysis.

ventilation scheme in existing multifamily buildings.

Natural Gas savings for each ventilation type normalized per multifamily unit are listed in the below tables by climate zone. The air exchange rate baseline for the New Building energy simulations was 3.0ACH50 and the measure case was 0.6ACH50; whereas the baseline for the existing building energy simulations was 9.5ACH50 and the measure case was 3.0ACH50¹⁷⁸⁹.

Climate Zone (City based upon)	New Building Space Heating Savings (therms/unit)			
	Exhaust	Exhaust and half supply	Balanced	No ventilation
1 (Rockford)	10.3	14.6	23.2	22.3
2 (Chicago)	9.9	14.1	22.4	21.5
3 (Springfield)	8.6	12.2	19.4	18.7
4 (Belleville)	6.9	9.7	15.5	14.9
5 (Marion)	7.0	9.9	15.8	15.2

Climate Zone (City based upon)	Existing Building Space Heating Savings (therms/unit)			
	Exhaust	Exhaust and half supply	Balanced	No ventilation
1 (Rockford)	35.2	48.1	57.5	58.4
2 (Chicago)	34.0	46.4	55.5	56.3
3 (Springfield)	29.5	40.2	48.1	48.9
4 (Belleville)	23.5	32.1	38.3	38.9
5 (Marion)	24.0	32.8	39.2	39.8

$$\Delta Therms/unit = Therms_{ModeledSavings} \times Heating\ Efficiency_{Correction\ Factor} \times Volume_{Correction\ Factor}$$

Where:

Therms_{ModeledSavings} = From above tables depending on the building vintage, climate zone and ventilation system

HeatingEfficiency_{CorrectionFactor} = HeatingEfficiency_{Modeled}/HeatingEfficiency_{Actual}

Where:

HeatingEfficiency_{Modeled} = 0.75

HeatingEfficiency_{Actual} = the efficiency of the actual heating system. If unknown, use a correction factor of 1 for existing buildings and the applicable code baseline efficiency for new buildings.

Volume_{CorrectionFactor} = Volume_{Actual}/Volume_{Modeled}

¹⁷⁸⁹ Center for Energy and Environment. Demonstrating the Effectiveness of an Aerosol Sealant to Reduce Multi-Unit Dwelling Envelope Air Leakage. pp 76, 79. December 30, 2016. <http://mn.gov/commerce-stat/pdfs/card-cee-aerosol.pdf#page=47&zoom=100,0,404>

Where:

$$\text{Volume}_{\text{Modeled}} = 12,000 \text{ ft}^3$$

$\text{Volume}_{\text{Actual}}$ = Volume of the actual unit. If unknown, use a correction factor of 1.

For example, An existing 1,000 sq.ft. multi-family unit with 10 ft. ceilings, 80% efficiency central boiler in a 6-unit building in Chicago with no dedicated ventilation is sealed using whole home aerosol sealing technique. The annual natural gas savings for the measure from the table would be -

$$\begin{aligned} \Delta\text{Therms} &= 56.3 \times (0.75/0.80) \times (10,000/12,000) \\ &= 43.9 \text{ therms} \end{aligned}$$

WATER AND OTHER NON-ENERGY IMPACT DESCRIPTIONS AND CALCULATION

N/A

DEEMED O&M COST ADJUSTMENT CALCULATION

N/A

MEASURE CODE: RS-SHL-AERO-V01-230101

REVIEW DEADLINE: 1/1/2026

5.6.11 Insulated Concrete Forms

DESCRIPTION

Insulated Concrete Forms (ICFs) are building assembly blocks that are used to construct walls of a building both above grade and below grade walls. They are made of lightweight, hollow foam blocks with reinforced steel bars that are filled with concrete. The foam blocks provide insulation, while the concrete provides strength and durability. ICFs are a popular construction method for energy-efficient and passive buildings because they provide excellent insulation, which can result in lower energy costs and a more comfortable living environment. They also have good soundproofing properties and can be used in areas with high wind and seismic activity. ICFs are easy to work with and can be assembled to fit the specific needs of a building. Additionally, ICFs are durable and long-lasting, and they require minimal maintenance over time.

Energy saving potential of ICFs walls when compared to traditional building wall construction assemblies, across residential building types is detailed in this measure. When considering a building material for both above grade and below grade (basement) walls, insulated concrete forms provide a high effective thermal resistance (R-value) and it eliminates the requirement of any additional insulation material. Heating and cooling energy reductions are derived from higher and continuous thermal resistance provided by ICFs walls leading to reduction in overall heating and cooling loads.

This measure was developed to be applicable to the following program types: NC. If applied to other program types, the measure savings should be verified.

DEFINITION OF EFFICIENT EQUIPMENT

ICFs assembly consist of a system of expanded or extruded polystyrene rigid insulation blocks separated by plastic webbing. Reinforcement bars are placed in the openings between the forms and concrete is poured and sandwiched between two layers of insulation material. The assembly provides continuous insulation and thermal mass across the building envelope. Effective thermal resistance R-values of the ICFs walls assembly are manufacturer published values to be used as a part of the measure. ICFs walls to be considered in this measure should have assembly U-values that shall exceed minimum required assembly R-values as defined by International Energy Efficiency Code¹⁷⁹⁰, listed below. A heated basement condition shall be required to utilize measure savings in below grade applications.

ICF Above grade wall assembly R-value >22.2 (hr $ft^2\text{°F}/\text{Btu}$)

ICF Below grade wall assembly R-value > 20 (hr $ft^2\text{°F}/\text{Btu}$)

DEFINITION OF BASELINE EQUIPMENT

Widely prevalent traditional building wall construction types^{1791 1792} listed in table below are considered as baseline for this measure. Thermal resistance R-values corresponding to code required thermal transmittance U-value listed in 2021 International energy conservation code. These values are to be used in prescriptive energy saving calculation methodology.

¹⁷⁹⁰ 2021 International Energy Efficiency Code, Chapter 4 Residential energy efficiency, section R402, table R402.1.2. Minimum assembly R values are calculated from listed assembly maximum U values for wooden frame and basement walls.

¹⁷⁹¹ U.S. Building Stock Characterization Study by National Renewable Energy Laboratory. [US Building Typology Segmentation Residential | Tableau Public. Data shows that 84% of the single-family homes and 30-74% of Multifamily homes in Illinois are built with wood frame construction since the 1980s.](#)

¹⁷⁹² A technology report from Portland Cement Association briefs¹⁷⁹², lists Concrete as the most common product of choice for basement construction with 98% of North American basements built of one of many available concrete wall systems. [Concrete Basements | Concrete Construction Magazine](#)

Wall Type	Type	Code	Zone	Assembly U-Value (Max.)	Corresponding Assembly R-Value (Min.) ¹⁷⁹³
Above grade wall	Wood Frame Wall	2021 IECC (Residential)	All	0.045	22.2
Below grade wall	Basement Wall		Zone 4	0.059	16.9
			Zone 5	0.05	20

Note: U Values and R values listed are in Imperial units. U-value: (Btu/hr ft²°F), R-value: (hr ft²°F/ Btu)

DEEMED LIFETIME OF EFFICIENT EQUIPMENT

The expected measure life is assumed to be 50 years¹⁷⁹⁴.

DEEMED MEASURE COST

The actual capital cost for this measure should be used in screening. If unknown, use total measure cost listed in table below include the cost of ICF blocks, concrete, reinforcement materials and labor. Incremental costs are compared against a wood frame wall for above grade walls and a standard concrete wall for below grade walls. Manufacturer specified R-values of ICF block/panels and actual concrete type R values shall be used to calculate ICF assembly R-value.

ICF Core thickness ¹⁷⁹⁵	Total Measure cost ¹⁷⁹⁶ (\$/Square ft of wall area)	Incremental cost against above grade wood frame wall ¹⁷⁹⁷ (\$/Square ft of wall area)	Incremental cost against Basement concrete wall ¹⁷⁹⁸ (\$/Square ft of wall area)	ICF assembly R-Value ^{1799 1800} (ft ² ·°F·h /BTU)
4"	12.14	6.58	6.94	23.9
6"	13.20	7.64	5.85	27.1
8"	16.37	10.81	8.34	28.4

¹⁷⁹³ 2021 International Energy conservation code (IECC) lists maximum allowable U-value for wood frame walls under residential energy efficiency section. Minimum required R-value is calculated as a reciprocal of the 2021 IECC listed U- value for wood frame walls. U-values correspond to climate zones 5A and 4C for Illinois.

¹⁷⁹⁴ While manufacturers claim the lifetime of the foam exceeds 100 years, due to likely degradation and or changes to the building shell over that timeframe, the TAC proposed a measure life of 50 years.

¹⁷⁹⁵ Core thickness indicate the space in between the EPS panels in ICF assembly.

¹⁷⁹⁶ Total measure costs include ICF blocks, concrete, rebar and labor costs. ICF block pricing information from ICF manufacturer Build Block and Fox blocks. Concrete costs and labor costs are from RSMeans 2023 residential cost database.

¹⁷⁹⁷ Baseline above grade wood frame wall cost include wall framing cost and code minimum insulation (cavity insulation and continuous insulation). These costs are referenced from 2023 RSMeans residential cost database.

¹⁷⁹⁸ Baseline basement wall costs include concrete, labor and code minimum insulation. These costs are referenced from 2023 RSMeans residential cost database.

¹⁷⁹⁹ National Concrete Masonry Association listed R-Value per thickness for different Concrete densities is utilized to calculated ICF assembly R-Values. A concrete density of 105 lb/ft³ is assumed for calculation purpose. Actual Concrete R-Value should be used in the measure. [R-VALUES AND U-FACTORS OF SINGLE WYTHE CONCRETE MASONRY WALLS - NCMA](#)

¹⁸⁰⁰ An R-value of 4.2 ft²·°F·h /BTU-inch is used for calculating R-value of ICF blocks with a total thickness of 5.25". ICF blocks from manufacturers Buildblock and Fox block are considered for this analysis.

<https://buildblock.com/download/r-value-and-performance-of-buildblock-and-buildlock-knockdown-insulating-concrete-forms/?tmstv=1683660365>

<https://buildblock.com/technical-support/product-specifications/>

<https://www.foxblocks.com/resources?category=specifications-guides>

LOADSHAPE

Loadshape R08 - Residential Cooling

Loadshape R09 - Residential Electric Space Heat

Loadshape R10 - Residential Electric Heating and Cooling

COINCIDENCE FACTOR

The summer peak coincidence factor for cooling is provided in two different ways below. The first is used to estimate peak savings during the utility peak hour and is most indicative of actual peak benefits, and the second represents the average savings over the defined summer peak period and is presented so that savings can be bid into PJM’s capacity market.

CF _{SSP}	= Summer System Peak Coincidence Factor for Central A/C (during utility peak hour) = 68% ¹⁸⁰¹
CF _{SSP SF}	= Summer System Peak Coincidence Factor for Heat Pumps in single-family homes (during system peak hour) = 72% ¹⁸⁰²
CF _{SSP, MF}	= Summer System Peak Coincidence Factor for Heat Pumps in multi-family homes (during system peak hour) = 67% ¹⁸⁰³
CF _{PJM}	= PJM Summer Peak Coincidence Factor for Central A/C (average during PJM peak period) = 46.6% ¹⁸⁰⁴
CF _{PJM SF}	= PJM Summer Peak Coincidence Factor for Heat Pumps in single-family homes (average during PJM peak period) = 46.6% ¹⁸⁰⁵
CF _{PJM, MF}	= PJM Summer Peak Coincidence Factor for Heat Pumps in multi-family homes (average during peak period) = 28.5%

¹⁸⁰¹ Based on metering of 24 homes with central AC during PY4 and PY5 in Ameren Illinois service territory.

¹⁸⁰² Based on analysis of metering results from 24 heat pumps in Ameren Illinois service territory in PY5 coincident with AIC’s 2010 system peak; ‘Impact and Process Evaluation of Ameren Illinois Company’s Residential HVAC Program (PY5)’.

¹⁸⁰³ Multifamily coincidence factors both from; *All-Electric Homes PY6 Metering Results: Multifamily HVAC Systems*, Cadmus, October 2015

¹⁸⁰⁴ Based on analysis of Itron eShape data for Missouri, calibrated to Illinois loads, supplied by Ameren. The average AC load over the PJM peak period (1-5pm, M-F, June through August) is divided by the maximum AC load during the year.

¹⁸⁰⁵ Based on analysis of Itron eShape data for Missouri, calibrated to Illinois loads, supplied by Ameren. The average AC load over the PJM peak period (1-5pm, M-F, June through August) is divided by the maximum AC load during the year.

Algorithm

CALCULATION OF ENERGY SAVINGS

ELECTRIC ENERGY SAVINGS

Following engineering algorithms can be used to calculate electric energy savings due to ICFs.

$$\Delta kWh = (\Delta kWh_{cooling} + \Delta kWh_{heatingElectric} + \Delta kWh_{heatingGas})$$

Where:

$\Delta kWh_{Cooling}$ = If central cooling, reduction in annual cooling requirement due to ICF insulation
 $= (((1/R_{base\ AG} - 1/R_{ICF_AG}) * A_{wall\ AG}) * 24 * CDD65 * DUA) / (1000 * \eta_{Cool}) * ADJ_{WallCool} * \%Cool$

$R_{base\ AG}$ = Thermal resistance R-value of the baseline above grade exterior wall assembly in IP units $ft^2 \cdot ^\circ F \cdot h / BTU$
 $= 22.2\ ft^2 \cdot ^\circ F \cdot h / BTU^{1806}$

R_{ICF_AG} = $R_{ICF\ block} + R_{Concrete} + R_{ICF\ inserts}$

$R_{ICF\ block}$ = Rated R-value of the wall assembly as provided by the manufacturer. IP units $ft^2 \cdot ^\circ F \cdot h / BTU$
 = If unknown, Use R-Value per inch of ICF panel thickness¹⁸⁰⁷ of 4.2 h $ft^2 \cdot ^\circ F / BTU$ -inch

$R_{Concrete}$ = Actual R-value of the concrete used in the ICF assembly
 = R-Value per inch * Concrete thickness, If unknown, use table below^{1808 1809}

Concrete density lb/ft ³	R-Value per inch
85	0.3
95	0.25
105	0.20
115	0.17
125	0.14
135	0.11
145	0.075

$R_{ICF\ inserts}$ = R-value of any additional ICF inserts/panels in the actual assembly

$A_{wall\ AG}$ = Net area of the above grade exterior wall envelope in ft^2

DUA = Discretionary Use Adjustment (reflects the fact that people do not always operate their AC when conditions may call for it).
 $= 0.75^{1810}$

¹⁸⁰⁶ Calculated based on maximum assembly U-value requirement for a wood frame wall from 2021 IECC, [Rmin=1/Umax, CHAPTER 4 \[RE\] RESIDENTIAL ENERGY EFFICIENCY, 2021 International Energy Conservation Code \(IECC\) | ICC Digital Codes \(iccsafe.org\)](#)

¹⁸⁰⁷ [BB-R-value-and-Performance-of-BuildBlock-ICFs-2014.pdf](#)

¹⁸⁰⁸ National Concrete Masonry Association, Thermal data Table 5, <https://ncma.org/resource/rvalues-ufactors-of-single-wythe-concrete-masonry-walls/>

¹⁸⁰⁹ https://www.concreteconstruction.net/_view-object?id=00000153-96ee-dbf3-a177-96ffa5500000

¹⁸¹⁰ This factor's source is: Energy Center of Wisconsin, May 2008 metering study; "Central Air Conditioning in Wisconsin, A Compilation of Recent Field Research", p31.

- 1000 = Converts Btu to kBtu
- CDD65 = Cooling Degree Days per year.
- = Dependent on location:¹⁸¹¹

Climate Zone (City based upon)	CDD 65
1 (Rockford)	877
2 (Chicago)	1047
3 (Springfield)	1183
4 (Belleville)	1641
5 (Marion/Murphysboro)	1450
Weighted Average ¹⁸¹²	1098

- η_{Cool} = Seasonal Energy Efficiency Ratio of cooling system (kBtu/kWh)
- = Actual (where it is possible to measure or reasonably estimate). Note where new HVAC is installed in addition to shell measures, the old HVAC unit efficiency should be used and the shell measure savings calculated first, the HVAC measure then assuming the reduced heat/cooling loads. If using rated efficiencies, derate efficiency value by 1% per year (maximum of 30 years) to account for degradation over time,¹⁸¹³ or if unknown assume the following.¹⁸¹⁴ If unknown value is used, it should not be derated by age.

Age of Equipment	SEER2 Estimate
Before 2006	9.5
2006 - 2014	12.4
Central AC After 1/1/2015	12.4
Heat Pump After 1/1/2015	13.3
Unknown (for use in program evaluation only)	10.0

- $ADJ_{WallCool}$ = Adjustment for cooling savings from wall insulation to account for inaccuracies in prescriptive engineering algorithms¹⁸¹⁵
- = 75%
- %Cool = Percent of homes that have cooling. Actual value shall be used.

Central Cooling	%Cool
Yes	100%
No	0%

¹⁸¹¹ National Centers for Environmental Information (NCEI) Annual Normals, from 2006 - 2020, calculated with a base temp of 65°F.

¹⁸¹² Weighted based on number of occupied residential housing units in each zone (US Census 2010).

¹⁸¹³ Justification for degradation factors can be found on page 14 of 'AIC HVAC Metering Study Memo FINAL 2_28_2018'. Estimate efficiency as (Rated Efficiency * (1-0.01)^Equipment Age).

¹⁸¹⁴ These default system efficiencies are based on the applicable minimum Federal Standards. In 2006 the Federal Standard for Central AC was adjusted. While one would expect the average system efficiency to be higher than this minimum, the likely degradation of efficiencies over time mean that using the minimum standard is appropriate. Note all ratings have been converted to SEER2 equivalents – since the new rating better reflects the actual efficiency of the units.

¹⁸¹⁵ As demonstrated in two years of metering evaluation by Opinion Dynamics, see Memo "Results for AIC PY6 HPwES Billing Analysis", dated February 20, 2015. TAC negotiated adjustment factor is 80%. During update cycle for version v.12, applied the percent change of NCEI Annual Normals CDD65 from 30 yr data set (1981-2010) to more recent 15 yr data (2006-2020) for all cooling-related adjustment values.

Central Cooling	%Cool
Unknown (for use in program evaluation only) ¹⁸¹⁶	66%

$$\Delta\text{kWh heating Electric} = \left(\left(\left(\left(\frac{1}{R_{\text{base AG}}} - \frac{1}{R_{\text{ICF AG}}} \right) * A_{\text{wall AG}} \right) + \left(\frac{1}{R_{\text{base AG basement}}} - \frac{1}{R_{\text{ICF AG basement}}} \right) * A_{\text{wall AG basement}} \right) + \left(\frac{1}{R_{\text{base BG basement}}} - \frac{1}{R_{\text{ICF BG basement}}} \right) * A_{\text{wall BG basement}} \right) * 24 * \text{HDD60} / (3412 * \eta_{\text{Heat}}) * \text{ADJ}_{\text{Wallheat}} * \%_{\text{ElectricHeat}}$$

A_{wall AG basement} = Net area of the above grade exterior basement wall envelope in ft²

A_{wall BG basement} = Net area of the below grade exterior basement wall envelope in ft²

R_{base AG basement} = R_{basement wall}

R_{basement wall} = Thermal resistance R-value of the baseline basement wall assembly in IP units ft²·°F·h/BTU

= 16.9 ft²·°F·h/BTU for a basement wall in Climate zone 4 20 ft²·°F·h/BTU for a basement wall in Climate zone 5¹⁸¹⁷

R_{ICF AG basement} = R_{ICF block} + R_{Concrete} + R_{ICF Inserts}

R_{base BG basement} = R_{basement wall} + R_{earth average}

R_{earth average} = Average R value of earth from table below

Below Grade R- Value ¹⁸¹⁸									
Depth below grade (ft)	0	1	2	3	4	5	6	7	8
Average Earth R-value (ft ² ·°F·h/BTU)	2.44	3.47	4.41	5.41	6.42	7.46	8.46	9.53	10.69

R_{ICF BG basement} = R_{ICF block} + R_{Concrete} + R_{ICF Inserts} + R_{earth average}

HDD60 = Heating degree days as listed in table below

Climate Zone	HDD60
1(Rockford)	5230
2(Chicago)	4798
3(Springfield)	4266
4(Belleville)	3188
5(Marion)	3390
Weighted Average ¹⁸¹⁹	4631

¹⁸¹⁶Percentage of homes in Illinois that have central cooling from “Table HC7.9 Air Conditioning in Homes in Midwest Region, Divisions, and States, 2009” from Energy Information Administration, 2009 Residential Energy Consumption Survey.

¹⁸¹⁷ Calculated based on maximum assembly U-value requirement for a basement wall from 2021 IECC, R_{min} = 1/U_{max}, International energy conservation code 2021, chapter 4 residential energy efficiency, table R402.1.4 equivalent U-factors.

¹⁸¹⁸ 2022 Illinois Statewide Technical reference manual for energy efficiency version 10.0, volume 3: Residential measures, 5.6.2 Basement sidewall insulation.

¹⁸¹⁹ 2022 Illinois Statewide Technical reference manual for energy efficiency version 10, volume 3: Residential measures, 5.6.2 Basement sidewall insulation.

- 3412 = Conversion factor from Btu to kWh
- η_{Heat} = Efficiency of heating system
- = Actual value or if known, refer to table below

System Type	Age of Equipment	HSPF2 Estimate	η_{Heat} (Effective COP Estimate * Distribution Efficiency)= (HSPF2/3.413)*0.85
Heat Pump (if age unknown assume 2006-2014)	Before 2006	5.8	1.44
	2006 - 2014	6.5	1.62
	2015 on	7.0	1.74
Resistance	N/A	N/A	1.00
Unknown (for use in program evaluation only) ¹⁸²⁰	N/A	N/A	1.32

$ADJ_{Wallheat}$ = Adjustment for heating savings to account for inaccuracies in prescriptive engineering algorithms¹⁸²¹
 =63%

%Electric Heat = Percent of homes that have electric space heating Actual value or Actual planned value during engineering design shall be used.
 = 0 % for Natural Gas, 100 % for Electric Resistance or Heat Pump, Actual electric % value if both fuel sources are used.
 = If unknown¹⁸²², use the following table:

Utility	Location				
	Single Family	Single Family Low Income	Multi Family	Multi Family Low Income	Unknown
Ameren	18%	26%	38%	39%	29%
ComEd	14%	22%	43%	48%	21%
PGL	1.0%	1.5%	4.0%	2.8%	2.2%
NSG	1.3%	0.8%	32.5%	1.2%	3.3%
Nicor	1.3%	0.8%	32.5%	1.2%	3.3%

¹⁸²⁰ Calculation assumes 35% Heat Pump and 65% Resistance, which is based upon data from Energy Information Administration, 2009 Residential Energy Consumption Survey, see “HC6.9 Space Heating in Midwest Region.xls”, using average for East North Central Region. Average efficiency of heat pump is based on assumption that 50% are units from before 2006 and 50% from 2006-2014. Program or evaluation data should be used to improve this assumption if available.

¹⁸²¹ As demonstrated in two years of metering evaluation by Opinion Dynamics, see Memo “Results for AIC PY6 HPwES Billing Analysis”, dated February 20, 2015. TAC negotiated adjustment factor is 60%. During update cycle for version v.12, applied the percent change of NCEI Annual Normals HDD60 from 30 yr data set (1981-2010) to more recent 15 yr data (2006-2020) for all heating-related adjustment values.

¹⁸²² Based on the average % Natural Gas used for space heating in Unknown residential structure types across all utilities covered by the IL program. Residence types include: SF, SF LI, MF & MF LI. Utilities included: Ameren, ComEd, People’s Gas, Northshore Gas & Nicor. Data provided from 2016 Ameren Illinois Demand Side Management (DSM) Market Potential Study by Applied Energy Group, ComEd’s 2019 Baseline Survey on residential space heating share, and PY2022-2023 Implementation Contractors Data for People’s Gas, Northshore Gas & Nicor .

Utility	Location				
	Single Family	Single Family Low Income	Multi Family	Multi Family Low Income	Unknown
All DUs ¹⁸²³					26%

Note: If a measure is supported by a gas and electric utility through a joint program, and it is unknown whether the participant has a gas supply, the electric utility values in the table above should be used. If it is known that the participant has a gas supply, the values from the gas utility above should be applied.

ΔkWh heating Gas = If gas furnace heat, kWh savings for reduction in fan run time
 = $\Delta Therms * Fe * 29.3$

Fe = Furnace Fan energy consumption as a percentage of annual fuel consumption
 = 3.14%^{1824 1825}

29.3 = kWh per therm

SUMMER COINCIDENT PEAK DEMAND SAVINGS

$\Delta kW = (\Delta kWh \text{ cooling} / FLH \text{ cooling}) * CF$

Where:

FLH cooling = Full load hours of air conditioning
 = Dependent on location:¹⁸²⁶

Climate Zone (City based upon)	Single Family	Multifamily
1 (Rockford)	547	499
2 (Chicago)	709	629
3 (Springfield)	779	707
4 (Belleville)	1082	982
5 (Marion/Murphysboro)	956	868
Weighted Average ¹⁸²⁷	676	603
ComEd	875	791
Ameren	731	655

¹⁸²³ For the weighted average calculations, please see the Analysis file. PGL, NSG, Nicor & gas customers were assumed to follow the provided split. ComEd total customers, minus overlap with PGL,NSG & Nicor, therefore electric only homes. Ameren is total customers minus Nicor.

¹⁸²⁴ Fe is not one of the AHRI certified ratings provided for residential furnaces but can be reasonably estimated from a calculation based on the certified values for fuel energy (Ef in MMBtu/yr) and Eae (kWh/yr). An average of a 300-record sample (non-random) out of 1495 was 3.14%. This is, appropriately, ~50% greater than the ENERGY STAR version 3 criteria for 2% Fe. See “Programmable Thermostats Furnace Fan Analysis.xlsx” for reference.

¹⁸²⁵ 2022 Illinois Statewide Technical reference manual for energy efficiency version 11.0, volume 3: Residential measures, 5.6.2 Basement sidewall insulation.

¹⁸²⁶ Full load hours for Chicago, Moline and Rockford are provided in “Final Evaluation Report: Central Air Conditioning Efficiency Services (CACES), 2010, Navigant Consulting”, p.33. An average FLH/Cooling Degree Day (from NCDC) ratio was calculated for these locations and applied to the CDD of the other locations in order to estimate FLH. During update cycle for version v.12, applied percent change of CDD65, NCEI Annual Normals from 30 yr data set (1981-2010) to more recent 15 yr data (2006-2020) to all FLHcool values.

¹⁸²⁷ Weighting for Ameren is based on electric accounts in each of the cooling zones. Weighting for ComEd and Statewide average is based on number of occupied residential housing units in each zone. ComEd is weighted average of Zones 1-2. Alternative program-weighted assumptions can be used if appropriate.

Climate Zone (City based upon)	Single Family	Multifamily
Statewide		

Use Multifamily if the building meets utility’s definition for multifamily and HVAC system serves single unit. For residential sized systems serving 2 or more units, assume single family hours.

- CF_{SSP} = Summer System Peak Coincidence Factor for Central A/C (during utility peak hour)
= 68%¹⁸²⁸
- CF_{SSP SF} = Summer System Peak Coincidence Factor for Heat Pumps in single-family homes (during system peak hour)
= 72%¹⁸²⁹
- CF_{SSP, MF} = Summer System Peak Coincidence Factor for Heat Pumps in multi-family homes (during system peak hour)
= 67%¹⁸³⁰
- CF_{PJM} = PJM Summer Peak Coincidence Factor for Central A/C (average during PJM peak period)
= 46.6%¹⁸³¹
- CF_{PJM SF} = PJM Summer Peak Coincidence Factor for Heat Pumps in single-family homes (average during PJM peak period)
= 46.6%¹⁸³²
- CF_{PJM, MF} = PJM Summer Peak Coincidence Factor for Heat Pumps in multi-family homes (average during peak period)
= 28.5%

FOSSIL FUEL SAVINGS

$$\Delta\text{Therms} = (((1/R_{\text{base AG}} - 1/R_{\text{ICF_AG}}) * A_{\text{wall AG}}) + ((1/R_{\text{base BG}} - 1/R_{\text{ICF_BG}}) * A_{\text{wall BG}}) * 24 * \text{HDD65}) / (\eta_{\text{Heat}} * 100,000 \text{ Btu/therm})) * \text{ADJ}_{\text{wallheat}} * \% \text{FossilHeat}$$

Where:

- η_{heat} = Efficiency of the heating system
= Actual or if known use values from table below

Equipment type	Age of equipment	AFUE ¹⁸³³
Gas Furnaces	After 11/19/2015	80%

¹⁸²⁸ Based on metering of 24 homes with central AC during PY4 and PY5 in Ameren Illinois service territory.
¹⁸²⁹ Based on analysis of metering results from 24 heat pumps in Ameren Illinois service territory in PY5 coincident with AIC’s 2010 system peak; ‘Impact and Process Evaluation of Ameren Illinois Company’s Residential HVAC Program (PY5)’.
¹⁸³⁰ Multifamily coincidence factors both from; *All-Electric Homes PY6 Metering Results: Multifamily HVAC Systems*, Cadmus, October 2015
¹⁸³¹ Based on analysis of Itron eShape data for Missouri, calibrated to Illinois loads, supplied by Ameren. The average AC load over the PJM peak period (1-5pm, M-F, June through August) is divided by the maximum AC load during the year.
¹⁸³² Based on analysis of Itron eShape data for Missouri, calibrated to Illinois loads, supplied by Ameren. The average AC load over the PJM peak period (1-5pm, M-F, June through August) is divided by the maximum AC load during the year.
¹⁸³³ Code of federal regulations, title 10, chapter ii, subchapter D, part 430, subpart C Energy and water conservation standards.
[eCFR :: 10 CFR Part 430 Subpart C -- Energy and Water Conservation Standards](https://www.ecfr.gov/current/title-10/chapter-II/subchapter-D/part-430/subpart-C)

Gas fired hot water Boilers	After 1/15/2021	84%
	9/1/2012- 1/15/2021	82%
Gas fired steam Boilers	After 1/15/2021	82%
	9/1/2012- 1/15/2021	80%

ADJ_{Wallheat} = Adjustment for heating savings to account for inaccuracies in prescriptive engineering algorithms¹⁸³⁴

= 60%

%FossilHeat = Percent of homes that have gas space heating. Actual value or Actual planned value during engineering design shall be used.

= 100 % for Natural Gas, 0 % for Electric Resistance or Heat Pump, Actual gas % value if both fuel sources are used.

= If unknown¹⁸³⁵, use the following table:

Utility	Location				
	Single Family	Single Family Low Income	Multi Family	Multi Family Low Income	Unknown
Ameren	82%	74%	62%	61%	71%
ComEd	86%	78%	57%	52%	79%
PGL	98.9%	98.5%	96.0%	96.9%	97.7%
NSG	98.3%	99.2%	67.5%	98.8%	96.6%
Nicor	98.3%	99.2%	67.5%	98.8%	96.6%
All DUs ¹⁸³⁶					74%

Note: If a measure is supported by a gas and electric utility through a joint program, and it is unknown whether the participant has a gas supply, the electric utility values in the table above should be used. If it is known that the participant has a gas supply, the values from the gas utility above should be applied.

¹⁸³⁴ As demonstrated in two years of metering evaluation by Opinion Dynamics, see Memo “Results for AIC PY6 HPwES Billing Analysis”, dated February 20, 2015. TAC negotiated adjustment factor is 60%.

¹⁸³⁵ Based on the average % Natural Gas used for space heating in Unknown residential structure types across all utilities covered by the IL program. Residence types include: SF, SF LI, MF & MF LI. Utilities included: Ameren, ComEd, People’s Gas, Northshore Gas & Nicor. Data provided from 2016 Ameren Illinois Demand Side Management (DSM) Market Potential Study by Applied Energy Group, ComEd’s 2019 Baseline Survey on residential space heating share, and PY2022-2023 Implementation Contractors Data for People’s Gas, Northshore Gas & Nicor .

¹⁸³⁶ For the weighted average calculations, please see the Analysis file. PGL, NSG, Nicor & gas customers were assumed to follow the provided split. ComEd total customers, minus overlap with PGL,NSG & Nicor, therefore gas only homes. Ameren is total customers minus Nicor.

For Example, a one-story single-family home in Chicago with above ground wall area of 1,500 square feet and basement 8 feet completely below ground with a wall area of 1000 square feet is built with ICF construction with R-33 ICF blocks with 6" core thickness and concrete R-value per inch of 0.2 ft²·°F·h/BTU-inch. The home has a 13.4 SEER Central AC and 2.2 COP Heat pump.

$$\Delta\text{kWh Cooling} = \left\{ \left[\left(\frac{1}{R_{\text{base AG}}} - \frac{1}{R_{\text{ICF_AG}}} \right) \cdot A_{\text{wall AG}} \right] \cdot 24 \cdot \text{CDD65} \cdot \text{DUA} \right\} / (1000 \cdot \eta_{\text{Cool}}) \cdot \text{ADJ}_{\text{WallCool}} \cdot \%_{\text{Cool}}$$

$$\Delta\text{kWh Cooling} = \left\{ \left[\left(\frac{1}{22.2} - \frac{1}{(33+(6 \cdot 0.2))} \right) \cdot 1,500 \right] \cdot 24 \cdot 1047 \cdot 0.75 \right\} / (1,000 \cdot 13.2) \cdot 0.75 \cdot 1$$

$$= 25.39 \text{ kWh}$$

$$\Delta\text{kWh heating} = \left\{ \left[\left(\frac{1}{22.2} - \frac{1}{(33+(6 \cdot 0.2))} \right) \cdot 1,500 \right] + \left[\left(\frac{1}{(20+10.69)} - \frac{1}{(34.2+10.69)} \right) \cdot 1000 \right] \right\} \cdot 24 \cdot 4798 / (3412 \cdot 2.2) \cdot 0.63 \cdot 1$$

$$= 328.74 \text{ kWh}$$

$$\Delta\text{kWh Savings} = 25.39 + 328.74$$

$$= 354.13 \text{ kWh}$$

Summer coincident peak demand savings during system peak hour

$$\Delta\text{kW}_{\text{SSP}} = (25.39/709) \cdot 0.68$$

$$= 0.024 \text{ kW}$$

Summer coincident peak demand savings (Average during peak period)

$$\Delta\text{kW}_{\text{PJM}} = (25.39/709) \cdot 0.466$$

$$= 0.017 \text{ kW}$$

For the same example with a Natural gas furnace with 80% efficiency for heating,

$$\Delta\text{Therms} = \left\{ \left[\left(\frac{1}{22.2} - \frac{1}{(33+(6 \cdot 0.2))} \right) \cdot 1,500 \right] + \left[\left(\frac{1}{(20+10.69)} - \frac{1}{(34.2+10.69)} \right) \cdot 1000 \right] \right\} \cdot 24 \cdot 4798 / (100,000 \cdot 0.8) \cdot 0.63 \cdot 1$$

$$= 30.85 \text{ Therms}$$

$$\Delta\text{kWh heating Gas} = 30.85 \cdot 0.0314 \cdot 29.3$$

$$= 28.4 \text{ kWh}$$

WATER AND OTHER NON-ENERGY IMPACT DESCRIPTIONS AND CALCULATION

N/A

DEEMED O&M COST ADJUSTMENT CALCULATION

N/A

MEASURE CODE: RS-SHL-ICF-V02-250101

REVIEW DEADLINE: 1/1/2027

5.7 Miscellaneous

5.7.1 High Efficiency Pool Pumps

DESCRIPTION

Residential outdoor pool pumps can be single speed, two/multi speed or variable speed. A federal standard (82 FR 5650) effective July 19, 2021, which requires new pumps to be at least two speed.

Single speed pumps are often oversized, and run frequently at constant flow regardless of load. Single speed pool pumps require that the motor be sized for the task that requires the highest speed. As such, energy is wasted performing low speed tasks at high speed. Two speed and variable speed pool pumps reduce speed when less flow is required, such as when filtering is needed but not cleaning, and have timers that encourage programming for fewer on-hours. Variable speed pool pumps use advanced motor technologies to achieve efficiency ratings of 90% while the average single speed pump will have efficiency ratings between 30% and 70%.¹⁸³⁷

This measure is the characterization of the purchasing and installing of a new ENERGY STAR or CEE T1 variable speed residential pool pump motor in place of a new baseline pump meeting the federal standard for Time of Sale and New Construction, or the early replacement of a standard single speed motor of equivalent horsepower.

This measure was developed to be applicable to the following program types: TOS, NC, RF.

If applied to other program types, the measure savings should be verified.

DEFINITION OF EFFICIENT EQUIPMENT

The high efficiency equipment is an ENERGY STAR or CEE Tier residential pool pump meeting the ENERGY STAR minimum qualifications for either in-ground or above ground pools. ENERGY STAR version 3.0 specification takes effect on July 19, 2021. Note that for in ground pools, the CEE T1 level is the same as the new Federal Standard, and Tier 2 is the same as ENERGY STAR V3 for the standard size pumps, so savings for CEE T1 is only provided for above ground pools where there is an increment in efficiency.

Pump Sub-Type	Size Class	ENERGY STAR Version 3.1 Energy Efficiency Level	CEE Tier 1	CEE Tier 2
Self-Priming (Inground) Pool Pumps	Extra Small (hhp ≤ 0.13)	WEF ≥ 13.40	N/A	N/A
	Small (hhp > 0.13 and < 0.711)	WEF ≥ -2.45 x ln (hhp) + 8.40	WEF ≥ -1.30 x ln (hhp) + 4.95	WEF ≥ -2.83 x ln (hhp) + 8.84
	Standard Size (hhp ≥ 0.711)	WEF ≥ -2.45 x ln (hhp) + 8.40	WEF ≥ -2.3 x ln (hhp) + 6.59	WEF ≥ -2.45 x ln (hhp) + 8.4
Non-Self Priming (Aboveground) Pool Pumps	Extra Small (hhp ≤ 0.13)	WEF ≥ 4.92	N/A	N/A
	Standard Size (hhp > 0.13)	WEF ≥ -1.00 x ln (hhp) + 3.85	WEF ≥ -1.60 x ln (hhp) + 9.10	N/A

DEFINITION OF BASELINE EQUIPMENT

For TOS and NC, the baseline equipment is a two speed residential pool pump meeting the Federal Standard, provided below:

¹⁸³⁷ U.S. DOE, 2012. Measure Guideline: Replacing Single-Speed Pool Pumps with Variable Speed Pumps for Energy Savings. Report No. DOE/GO-102012-3534.

Pump Sub-Type	Size Class	Baseline
Self-Priming (Inground) Pool Pumps	Extra Small (hhp ≤ 0.13)	WEF ≥ 5.55
	Small (hhp > 0.13 and < 0.711)	WEF ≥ -1.30 x ln (hhp) + 2.90
	Standard Size (hhp ≥ 0.711)	WEF ≥ -2.30 x ln (hhp) + 6.59
Non-Self Priming (Aboveground) Pool Pumps	Extra Small (hhp ≤ 0.13)	WEF ≥ 4.60
	Standard Size (hhp > 0.13)	WEF ≥ -0.85 x ln (hhp) + 2.87

For early replacement, the baseline equipment is the existing single speed residential pool pump.

DEEMED LIFETIME OF EFFICIENT EQUIPMENT

The estimated useful life for a two speed or variable speed pool pump is 7 years.¹⁸³⁸

DEEMED MEASURE COST

For TOS and NC, the incremental costs for ENERGY STAR in-ground pool pumps are estimated as \$314¹⁸³⁹ and for above ground pool pumps are estimated as \$930.¹⁸⁴⁰

For early replacement, the full replacement costs shall be used. A deferred new baseline cost (after 4 years) of replacing the existing equipment should also be included.

LOADSHAPE

Loadshape R15 – Residential Pool Pumps

COINCIDENCE FACTOR

The coincidence factor for this measure is assumed to be 0.831.¹⁸⁴¹

Algorithm

CALCULATION OF ENERGY SAVINGS

ELECTRIC ENERGY SAVINGS¹⁸⁴²

For TOS and NC:

$$\Delta kWh = (\text{Gallons} * \text{Turnovers} * (1/WEF_{\text{base}} - 1/WEF_{\text{ESTAR}}) * \text{Days}) / 1000$$

For Early Replacement:

$$\Delta kWh = (\text{Gallons} * \text{Turnovers} * (1/EF_{\text{Exist}} - 1/WEF_{\text{ESTAR}}) * \text{Days}) / 1000$$

Where:

$$\text{Gallons} = \text{Capacity of the pool}$$

¹⁸³⁸ As recommended in Navigant ‘ComEd Effective Useful Life Research Report’, May 2018.

¹⁸³⁹ ENERGY STAR Pool Pump Calculator and represent the difference between the two/multi speed incremental cost and the variable speed incremental cost.

¹⁸⁴⁰ CEE Efficient Residential Swimming Pool Initiative, December 2012, page 18 and represent the difference between the two/multi speed incremental cost and the variable speed incremental cost.

¹⁸⁴¹ Based on assumptions of daily load pattern through pool season. Assumption was developed for Efficiency Vermont but is considered a reasonable estimate for Illinois.

¹⁸⁴² The methodology followed is consistent with the most recent version of the 2020 ENERGY STAR calculator (Pool_Pump_Calculator_2020.05.05_FINAL.xls), however this has not been updated to account for the new federal standard.

= Actual. If unknown assume:

Pool Type	Gallons
In ground	22,000 ¹⁸⁴³
Above ground	7,540 ¹⁸⁴⁴

Turnovers = Desired number of pool water turnovers per day
= 2¹⁸⁴⁵

WEF_{base} = Weighted Energy Factor of baseline pump (gal/Wh) ¹⁸⁴⁶

Pool Type	WEF _{Base}
In ground	4.75
Above ground	2.58

WEF_{ESTAR} = Weighted Energy Factor of ENERGY STAR pump (gal/Wh) ¹⁸⁴⁷

Pool Type	WEF _{EE}	
	ENERGY STAR	CEE Tier 1
In ground	6.44	N/A
Above ground	3.51	8.55

EF_{Exist} = Energy Factor of existing single speed pump (gal/Wh)
= 2.3¹⁸⁴⁸

Days = Number of days per year that the swimming pool is operational
= 122¹⁸⁴⁹

1,000 = Conversion factor from Wh to kWh

Based on the defaults provided above, the annual energy savings (ΔkWh) are detailed in the table below:

Pool Type	ΔkWh			
	TOS/NC		Retrofit	
	ENERGY STAR	CEE T1	ENERGY STAR	CEE T1
In ground	296.0	N/A	1528.1	N/A
Above ground	188.4	496.9	285.7	594.2

¹⁸⁴³ Consistent with assumption in the 2020 ENERGY STAR calculator.

¹⁸⁴⁴ Based on typical pool sizes from “Evaluation of Potential Best Management Practices - Pools, Spas, and Fountains, The California Urban Water Conservation Council”, 2010.

¹⁸⁴⁵ Consistent with assumption in the 2020 ENERGY STAR calculator.

¹⁸⁴⁶ Based on applying the federal standard specifications to the average Curve-C rated hydraulic horsepower (hhp) from the ENERGY STAR Qualified Products List, accessed 5/03/2024.

¹⁸⁴⁷ Based on applying the ENERGY STAR and CEE Tier 1 specifications to the average Curve-C rated hydraulic horsepower (hhp) from the ENERGY STAR Qualified Products List, accessed 5/03/2024.

¹⁸⁴⁸ Consistent with assumption in the 2020 ENERGY STAR calculator, assuming 1.5 HP pump.

¹⁸⁴⁹ Consistent with assumption in the 2020 ENERGY STAR calculator.

SUMMER COINCIDENT PEAK DEMAND SAVINGS

For TOS and NC:

$$\Delta kW = ((kWh/day_{base}) / (Hrs/day_{base}) - (kWh/day_{ESTAR}) / (Hr/day_{ESTAR})) * CF$$

For Early Replacement:

$$\Delta kW = ((kWh/day_{Exist}) / (Hrs/day_{Exist}) - (kWh/day_{ESTAR}) / (Hr/day_{ESTAR})) * CF$$

Where:

kWh/day = daily energy consumption of pool pump, as defined above.
 = Actual, defaults provided below:

Pool Type	ΔkWh/day			
	Base	ENERGY STAR	CEE T1	Exist
In ground	9.3	6.8	N/A	19.4
Above ground	5.8	4.3	1.8	6.6

Hrs/day_{base} = daily run hours of pool pump
 = (Gallons * Turnover) / GPM

		Weighted Average GPM ¹⁸⁵⁰	Hours/Day
		In ground	Base
Efficient	32.2		22.8
Exist	78		9.4
Above ground	Base	44.7	5.6
	Efficient	27.3	9.2
	Exist	78.1	3.2

CF = Summer Peak Coincidence Factor for measure
 = 0.831¹⁸⁵¹

Based on defaults provided above:

Pool Type	ΔkW			
	TOS/NC		Retrofit	
	ENERGY STAR	CEE T1	ENERGY STAR	CEE T1
In ground	0.2087	N/A	1.4689	N/A
Above ground	0.4770	0.7059	1.3300	1.5590

Mid-Life Baseline Adjustment

For early replacement measures, to account for the fact that the existing pump would have needed to be replaced

¹⁸⁵⁰ The 2013 ENERGY STAR calculator provided high and low flow and hour assumptions for multi and variable speed pumps. This is used to estimate a weighted average GPM assumption, see 'IL TRM_Pool Pump Calculator_2024.xls'.

¹⁸⁵¹ Based on assumptions of daily load pattern through pool season. Assumption was developed for Efficiency Vermont but is considered a reasonable estimate for Illinois.

within the lifetime of the measure, a mid-life adjustment should be applied. This is calculated as the savings from the federal standard to the ESTAR pump divided by the savings from the existing pump. This should be applied after 4 years.

Based on defaults provided above:

Pool Type	Adjustment Factor applied to Annual kWh Savings	
	ENERGY STAR	CEE T1
In ground	19%	N/A
Above ground	66%	84%

FOSSIL FUEL SAVINGS

N/A

WATER IMPACT DESCRIPTIONS AND CALCULATION

N/A

DEEMED O&M COST ADJUSTMENT CALCULATION

N/A

MEASURE CODE: RS-MSC-RPLP-V04-250101

REVIEW DEADLINE: 1/1/2027

5.7.2 Low Flow Toilets

DESCRIPTION

The first federal standards dealing with water consumption for toilets was the Energy Policy Act of 1992. It specified a gallon per flush (gpf) standard for both fixtures. These standards are used to define the baseline equipment for this measure. The Subsequent U.S. EPA WaterSense program in 2009 set even tighter standards for plumbing fixtures, including toilets. These standards are used to define the efficient equipment for this measure.

DEFINITION OF EFFICIENT EQUIPMENT

The high efficiency equipment is a U.S. EPA WaterSense certified residential toilet fixture.

DEFINITION OF BASELINE EQUIPMENT

The baseline equipment is a toilet that has a maximum gallons per flush outlined by the Energy Policy Act of 1992.

DEEMED LIFETIME OF EFFICIENT EQUIPMENT

The estimated useful life for this measure is assumed to be 25 years.¹⁸⁵²

DEEMED MEASURE COST

The incremental costs for both are \$0.¹⁸⁵³

LOADSHAPE

Loadshape R03 - Residential Electric DHW

COINCIDENCE FACTOR

N/A

Algorithm

CALCULATION OF ENERGY SAVINGS

ELECTRIC ENERGY SAVINGS

The following savings should be included in the total savings for this measure, but should not be included in TRC tests to avoid double counting the economic benefit of water savings.

$$\Delta \text{kWh} = \Delta \text{Water} / 1,000,000 * E_{\text{water total}}$$

$$E_{\text{water}} = \text{IL Total Water Energy Factor (kWh/Million Gallons)}$$

$$= 5,010^{1854}$$

¹⁸⁵² http://www.metrohome.us/information_kit_files/life.pdf and ATD Home Inspection:

<http://www.atdhomeinspection.com/advice/average-product-life/> is 50 years. 25 years is used to be conservative.

¹⁸⁵³ Measure cost assumption from City of Fort Collins, "Green Building Practice Summary," March 21, 2011, page 2. The document states "Information from the EPA WaterSense web site: WaterSense® labeled toilets are not more expensive than regular toilets. MaP testing results have shown no correlation between price and performance. Prices for toilets can range from less than \$100 to more than \$1,000. Much of the variability in price is due to style, not functional design."

¹⁸⁵⁴ This factor includes 2571 kWh/MG for water supply based on Illinois energy intensity data from a 2012 ISAWWA study and 2439 kWh/MG for wastewater treatment based on national energy intensity use estimates. For more information please review Elevate Energy's 'IL TRM: Energy per Gallon Factor, May 2018 paper'.

Toilet Calculation

For example, a low flow toilet is installed in a single family home with unknown occupancy.

$$\begin{aligned} \Delta kWh &= 1495 / 1,000,000 * 5,010 \\ &= 7.5 \text{ kWh/year} \end{aligned}$$

SUMMER COINCIDENT PEAK DEMAND SAVINGS

N/A

FOSSIL FUEL SAVINGS

N/A

WATER IMPACT DESCRIPTIONS AND CALCULATION

$$\Delta Water = (GPF_{Base} - GPF_{Eff}) * NFPD * Household * ADPY$$

Where:

GPF_{Base} = Baseline equipment gallons per flush
 = 1.6 for toilets¹⁸⁵⁵

GPF_{Eff} = Efficient equipment gallons per flush
 = 1.28 for toilets¹⁸⁵⁶

NFPD = Number of flushes per day per occupant
 = 5¹⁸⁵⁷

Household = Number of people in the household.
 = Actual. If unknown assume average number of people per household:

Household Unit Type	Household ¹⁸⁵⁸		
	IQ Participants	Non-IQ Participants	All Participants
Single-Family - Deemed	2.76	2.62	2.67
Multifamily - Deemed	2.3	2.09	2.18
Household type unknown			2.52 ¹⁸⁵⁹
Custom	Actual Occupancy or Number of Bedrooms ¹⁸⁶⁰		

Use Multifamily if: Building meets utility’s definition for multifamily

ADPY = Annual days per year
 = 365 for residential

¹⁸⁵⁵ U. S. EPA WaterSense. “Water Efficiency Management Guide – Bathroom Suite” (EPA 832-F-17-016d), Nov 2017.

¹⁸⁵⁶ U. S. EPA WaterSense. “Water Efficiency Management Guide – Bathroom Suite” (EPA 832-F-17-016d), Nov 2017.

¹⁸⁵⁷ U.S. EPA WaterSense, “Water Specification for Flushing Urinals Supporting Statement.” Appendix B: References for Calculation Assumptions.

¹⁸⁵⁸ Assumptions are taken from the draft unadjusted 2024 Baseline Study evaluation data provided in 07/2024 by GDS Associates.

¹⁸⁵⁹ Unknown is based on statewide weighted average of 69% single family and 31% multifamily, based on IL data from 2009 RECS Table HC2.9 Structural and Geographic Characteristics of Homes in Midwest Region, Divisions and States, 2009.

¹⁸⁶⁰ Bedrooms are suitable proxies for household occupancy, and may be preferable to actual occupancy due to turnover rates in residency and non-adult population impacts.

Toilet Calculation

For example, a low flow toilet is installed in a single family IQ home with unknown occupancy.

$$\begin{aligned}\Delta\text{Water} &= (1.6 - 1.28) * 5 * 2.76 * 365 \\ &= 1612 \text{ gal/year}\end{aligned}$$

DEEMED O&M COST ADJUSTMENT CALCULATION

N/A

MEASURE CODE: RS-MSC-LFTU-V02-250101

REVIEW DEADLINE: 1/1/2029

5.7.3 Level 2 Electric Vehicle Charger

DESCRIPTION

The measure is for the purchase of a Level 2 electric vehicle charger consistent with the ENERGY STAR specification for Electric Vehicle Supply Equipment (EVSE) installed for residential household use. Networked chargers enable access to online energy management tools through an EVSE network. Non-networked chargers are standalone units that are not connected to other units through an EVSE network.

This measure was developed to be applicable to the following program types: TOS. If applied to other program types, the measure savings should be verified.

DEFINITION OF EFFICIENT EQUIPMENT

An ENERGY STAR qualified networked or non-networked level 2 electric vehicle charger.

DEFINITION OF BASELINE EQUIPMENT

A non-ENERGY STAR networked or non-networked level 2 electric vehicle charger.

DEEMED LIFETIME OF EFFICIENT EQUIPMENT

The expected measure life for the EV charger is assumed to be 10 years.¹⁸⁶¹

DEEMED MEASURE COST

The incremental cost for the EV charger is assumed to be \$84 for a non-networked charger and \$47 for a networked charger.¹⁸⁶²

LOADSHAPE

Loadshape R19 - Residential Electric Vehicle Charger

COINCIDENCE FACTOR

Coincidence factor is embedded in deemed demand reduction savings estimate, so the coincidence factor is assumed to be 1.

Algorithm

CALCULATION OF ENERGY SAVINGS

ELECTRIC ENERGY SAVINGS

$$\Delta kWh = (((Hours_PS + Hours_US) * SP_base) - (Hours_PS * SP_EEp + Hours_US * SP_EEu)) / 1000$$

Where:

$$\begin{aligned} \text{Hours_C} &= \text{Annual Active Charging Hours} \\ &= 278 \text{ hours}^{1863} \end{aligned}$$

¹⁸⁶¹ Based on Northwest Power and Conservation Council, Regional Technical Forum updated workbook for Level 2 Electric Vehicle Charger version 3.1. See 'Lvl2EVChgrsv2_3.xls'.

¹⁸⁶² Based on Northwest Power and Conservation Council, Regional Technical Forum updated workbook for Level 2 Electric Vehicle Charger version 3.1. See 'Lvl2EVChgrsv2_3.xls'.

¹⁸⁶³ Based on Northwest Power and Conservation Council, Regional Technical Forum updated workbook for Level 2 Electric Vehicle Charger version 3.1. See 'Lvl2EVChgrsv2_3.xls'.

Hours_P	= Total Annual Hours Plugged In = 3,511hours ¹⁸⁶⁴
Hours_PS	= Annual Standby Hours Plugged In = Hours_P - Hours_C = 3,233 hours
Hours_US	= Annual Standby Hours Unplugged = 8760 - Hours_P = 5,249 hours
SP_base	= Baseline Average Standby Power (W) = 3.7 for non-networked, 9.9 for networked ¹⁸⁶⁵
SP_EEp	= Efficient Average Standby Power (W) with vehicle plugged in = 3.5 for non-networked, 3.2 for networked ¹⁸⁶⁶
SP_EEu	= Efficient Average Standby Power (W) in no vehicle mode = 2.1 for non-networked, 2.5 for networked ¹⁸⁶⁷

$$\begin{aligned} \Delta\text{kWh per non-networked charger} &= (((3,233 + 5,249) * 3.7) - (3,233 * 3.5 + 5,249 * 2.1)) / 1000 \\ &= 9.0 \text{ kWh} \end{aligned}$$

$$\begin{aligned} \Delta\text{kWh per networked charger} &= (((3,233 + 5,249) * 9.9) - (3,233 * 3.2 + 5,249 * 2.5)) / 1000 \\ &= 60.5 \text{ kWh} \end{aligned}$$

SUMMER COINCIDENT PEAK DEMAND SAVINGS

$$\Delta\text{kW} = \text{AveragekW} * \text{CF}$$

Where:

AveragekW = Average electric demand during standby.

$$\begin{aligned} \text{Non-networked} &= (((3.7-3.5) * 3233/8482) + ((3.7-2.1) * 5249/8482))/1000 \\ &= 0.00107 \text{ kW} \end{aligned}$$

$$\text{Networked} = ((9.9-3.2) * 3233/8482) + ((9.9-2.5) * 5249/8482))/1000$$

¹⁸⁶⁴ Based on Northwest Power and Conservation Council, Regional Technical Forum updated workbook for Level 2 Electric Vehicle Charger version 3.1. See 'Lvl2EVChgrsv2_3.xls'.

¹⁸⁶⁵ INL charger testing <https://avt.inl.gov/evse-type/ac-level-2> and ENERGY STAR Market and Industry Scoping Report Electric Vehicle Supply Equipment (EVSE) September 2013 (source data is from INL).

¹⁸⁶⁶ 2021 ENERGY STAR QPL of Residential EVSE. Averaged Partial On Mode Input Power (W) and Idle Mode Input Power (W). See Northwest Power and Conservation Council, Regional Technical Forum updated workbook for Level 2 Electric Vehicle Charger version 3.1. See 'Lvl2EVChgrsv2_3.xls'.

¹⁸⁶⁷ 2021 ENERGY STAR QPL of Residential EVSE. See Northwest Power and Conservation Council, Regional Technical Forum updated workbook for Level 2 Electric Vehicle Charger version 3.1. See 'Lvl2EVChgrsv2_3.xls'.

= 0.00713 kW

CF = Summer peak coincidence factor
= 1

FOSSIL FUEL SAVINGS

N/A

WATER AND OTHER NON-ENERGY IMPACT DESCRIPTIONS AND CALCULATION

N/A

DEEMED O&M COST ADJUSTMENT CALCULATION

N/A

MEASURE CODE: RS-MSC-L2CH-V03-250101

REVIEW DEADLINE: 1/1/2029

5.7.4 Heat Pump Swimming Pool Heater

DESCRIPTION

This measure is applicable to electric heat pump pool heaters in residential applications. Heat pumps capture heat and move it from one place to another. The saving equations presented herein comprise three aspects of pool heating: convective heat loss via pool surface area due to water and air temperature differential, initial heat of full pool volume for seasonal pool use and reheat of pool refill on year round pools, and the heating of added pool water to offset water loss through evaporation.¹⁸⁶⁸ This measure applies to replacing either a gas-fired pool heater or a an electric resistance pool heater. If baseline equipment is a gas-fired pool heater, electric energy impacts result in additional electrical usage, but lower overall site energy usage.

This measure is only applicable to inground or outdoor single family home pools and is not applicable to spas. This measure is not applicable to community pools in multifamily housing complexes.¹⁸⁶⁹

This measure was developed to be applicable to the following program types: TOS, NC, EREP.

DEFINITION OF EFFICIENT EQUIPMENT

The efficient equipment is defined as a heat pump that is more efficient than Illinois energy code. This type of heat pump is designed to heat pool water for residential sized pools. Compliance condition of the equipment is that it is an AHRI-certified heat pump pool heater.

DEFINITION OF BASELINE EQUIPMENT

The baseline reflects the existing pool water heater which could be natural gas, electric resistance or a less electric efficient heat pump water heater. The baseline equipment must be less efficient than that new equipment.

Heating Type	Heat Pump Efficiency
Natural Gas	82% Thermal Efficiency ¹⁸⁷⁰
Electric Resistance	100%
Heat Pump	3.5 COP

The California Appliance Efficiency Regulations (Title 20) requires a minimum coefficient of performance (COP) of 3.5 for heat pump pool heaters and a minimum thermal efficiency (TE) of 82% for all natural residential pool water heaters.

DEEMED LIFETIME OF EFFICIENT EQUIPMENT

15 years.¹⁸⁷¹

DEEMED MEASURE COST

Estimated gross and incremental installation costs are listed below.¹⁸⁷² Costs include material cost of heat pump,

¹⁸⁶⁸ ASHRAE Handbook: HVAC Applications, 2019, pg 51.25. ASHRAE states that except in aboveground pools and rare cases where cold groundwater flows past the pool walls, conductive losses through pool walls are small and can be ignored. ASRHAЕ additionally indicates that radiation losses that occur due to sky temperature differentials at night may be offset by solar heat gains of an unshaded pool during the day.

¹⁸⁶⁹ New York Standard Approach for Estimating Energy Savings from Energy Efficiency Programs – Residential, Multi-family, and Commercial/Industrial Measures Version 9

¹⁸⁷⁰ Department of Energy. "10 CFR 430.32 - Energy and water conservation standards and their effective dates." Section (k) (2).

¹⁸⁷¹ Database for Energy Efficient Resources (DEER). "2014 DEER Update Study." July 17, 2013. <http://www.deeresources.com/files/home/download/DEER2014UpdatePlan-July2013-v1.pdf>

¹⁸⁷² California Technical Reference Manual for Energy Efficiency. Southern California Edison (SCE). 2021. "SWRE005-01 Cost Analysis.xlsm."

infrastructure for installation, and labor.

Equipment Type	Gross Cost	Incremental Cost
Gas Heater	\$5,158	N/A
Heat Pump Heater	\$7,074	\$1,916

LOADSHAPE

Loadshape R15 - Residential Pool Pumps

COINCIDENCE FACTOR

The prescribed value for the coincidence factor is 0 for outdoor pools and is 0.8 for indoor pools.

Algorithm

CALCULATION OF ENERGY SAVINGS

ELECTRIC ENERGY SAVINGS

Non fuel switch measures:

Net site energy consumed at the site is calculated below:

$$\Delta kWh = \frac{(BTU_{Surface} + BTU_{Reheat} + BTU_{Evap})}{3,412} * \left[\left(\frac{F_{fuel\ baseline}}{E_{t, baseline}} \right) + \left(\frac{F_{elec, baseline}}{COP_{baseline}} - \frac{1}{COP_{ee}} \right) \right]$$

Fuel switch measures:

Fuel switch measures must produce positive total lifecycle energy savings (i.e., reduction in Btus at the premises) in order to qualify. This is determined as follows:

$$SiteEnergySavings\ (MMBTUs) = [FossilHeatReplaced] - [ElectricHeatAdded]$$

$$FossilHeatReplaced = \frac{(BTU_{Surface} + BTU_{Reheat} + BTU_{Evap})}{1,000,000} * \left[\left(\frac{F_{fuel\ baseline}}{E_{t, baseline}} \right) \right]$$

$$ElectricHeatAdded = \frac{(BTU_{Surface} + BTU_{Reheat} + BTU_{Evap})}{1,000,000} * \left[\left(\frac{F_{fuel\ baseline}}{E_{t, baseline}} \right) + \left(\frac{F_{elec, baseline}}{COP_{baseline}} - \frac{1}{COP_{ee}} \right) \right]$$

If SiteEnergySavings calculated above is positive, the measure is eligible.

The appropriate savings claim is dependent on which utilities are supporting the measure as provided in a table below:

Measure supported by:	Electric Utility claims (kWh):	Gas Utility claims (therms):
Electric utility only	SiteEnergySavings * 1,000,000/3,412	N/A
Electric and gas utility (Note utilities may make alternative agreements to how savings are allocated as long as total MMBtu savings remains the same).	%IncentiveElectric * SiteEnergySavings * 1,000,000/3,412	%IncentiveGas * SiteEnergySavings * 10

Measure supported by:	Electric Utility claims (kWh):	Gas Utility claims (therms):
Gas utility only	N/A	SiteEnergySavings * 10

Where:

$BTU_{Surface}^{1873}$	= Annual heating energy load contributed by convection/radiation heat losses via pool surface $= (T_{pool} - T_{amb}) * A_{pool} * U * [hrs - (hrs_{cover} - ESF_{cover,surface})]$
BTU_{Reheat}^{1874}	= Annual heating energy load contributed by heating the full volume of pool water $= V_{pool} * 8.33 * (T_{pool} - T_{main}) * F_{Reheat}$
BTU_{Evap}^{1875}	= Annual heating energy load contributed by evaporation $= 0.1 * AF * A_{pool} * (P_w - P_{dp}) * (T_{pool} - T_{main}) * [hrs - (hrs_{cover} * ESF_{cover,evap})]$
$F_{elec,baseline}$	= Baseline electric pool heater factor; used to account for the presence or absence of an electric pool heater. = 1.0 if baseline system is electric resistance pool heater = 0 if baseline system is not an electric resistance pool heater
$F_{fuel,baseline}$	= Baseline fossil fuel pool heater factor; used to account for the presence or absence of a fossil fuel-fired pool heater. = 1.0 if baseline system is fossil fuel-fired pool heater = 0 if baseline system is not a fossil fuel-fired pool heater
$COP_{baseline}$	= Coefficient of performance, ratio of output energy/input energy of baseline electric resistance pool heater, if present. = 1.0 if heater is electric resistance; 3.5 if heater is a heat pump
COP_{ee}	= Coefficient of performance, ratio of output energy/input energy of heat pump pool heater. = Actual
$E_{t,baseline}$	= Thermal efficiency of baseline fossil fuel-fired pool heater, if present. = 0.82 if unknown
T_{pool}	= Pool temperature set point, (°F). = Actual
T_{amb}	= Average temperature of surrounding ambient air, (°F). If pool is indoors, this is the indoor temperature of room with pool from application. For outdoor pools, see “Ambient Air Temperature and Pressure (T_{amb} and P_{dp})” table below.
T_{main}	= Supply water temperature in water main, (°F). See “Cold Water Inlet Temperature (T_{main})” table below.

¹⁸⁷³ ASHRAE Handbook: HVAC Applications, 2019, Ch 51 Service Water Heating, Swimming Pools/Health Clubs.

¹⁸⁷⁴ Ibid, eqn. 14

¹⁸⁷⁵ ASHRAE Handbook: HVAC Applications, 2019, Ch 6 Indoor Swimming Pools, eqn. 3, multiplied by required heating temperature difference

A_{pool}	<p>= Surface area of pool, (ft²). From application. Assistance in determining the area of common pool shapes as follows:¹⁸⁷⁶</p> <p style="padding-left: 40px;">Elliptical: 3.14 x short radius x long radius</p> <p style="padding-left: 40px;">Kidney Shaped: 0.45 x length x (width at one end x width at other end)</p> <p style="padding-left: 40px;">Oval: 3.14 x radius² + (length of straight sides x width)</p> <p style="padding-left: 40px;">Rectangular: length x width</p>
V_{pool}	<p>= Volume of pool water, (gallons)</p> <p>= ActualFrom application.</p>
F_{Reheat}	<p>= Factor capturing annual number of times full pool volume is heated to the desired temperature, whether as the result of refill or heating of pool water from ground water temperature at start of season. From application.</p> <p>= 0 if pool is filled by delivery service providing preheated water</p> <p>= 1 if otherwise¹⁸⁷⁷</p>
U	<p>= Surface heat loss coefficient, (BTU/hr ft² °F)¹⁸⁷⁸</p> <p>= 3.9 for indoor pool</p> <p>= 5.3 for outdoor pool, sheltered</p> <p>= 6.6 for outdoor pool, unsheltered</p>
AF	<p>= Activity Factor, consideration of activity within pool, allowing for splashing and a limited area of wetted deck.¹⁸⁷⁹</p> <p>= 0.5</p>
P_{ω}	<p>= Saturation vapor pressure taken at surface water temperature, (in. Hg). See “Saturation Vapor Pressure (P_{ω})” table below based on pool water temperature.</p>
P_{dp}	<p>= Saturation pressure at dew point, (in. Hg). See “Ambient Air Temperature and Pressure (T_{amb} and P_{dp})” table below.</p>
hrs	<p>= Total annual swimming season hours. From application. Hours shall reflect the total annual hours through the swimming season (number of days between season opening and season closing x 24).</p>
$\text{hrs}_{\text{cover}}$	<p>= Total annual hours pool covered during the swimming season. From application. Hours shall reflect the total hours pool covered during the swimming season. Set equal to 0 if pool is left uncovered throughout swimming season.</p>
$\text{ESF}_{\text{cover,surface}}$	<p>= Energy Savings Factor of pool cover to insulate from convective and radiation heat</p>

¹⁸⁷⁶ Guidance for determining surface area of common pool shapes can be found at ASHRAE Handbook: HVAC Applications, 2019.

¹⁸⁷⁷ The water temperature of an undrained pool between swim seasons is assumed to have reached the water main temperature by the beginning of the next swim season. If the pool remains open throughout the year, it is assumed the pool undergoes one effective full pool volume reheat from water main temperature for cleaning and other maintenance (CDC, Healthy Swimming, Operating Public Swimming Pools).

¹⁸⁷⁸ ASHRAE Handbook: HVAC Applications, 2019, Ch 51, eqn. 15. Surface heat loss coefficient adjusted from ASHRAE Handbook rolled up surface heat transfer conservations by discounting contribution of evaporation (50-60%) and applying the following assumption for wind velocity: Indoor pools experience average wind speeds less than 3.5 mph (10.5x0.5x0.75), outdoor sheltered pools experience wind speeds between 3.5 and 5 mph (10.5x0.5), and outdoor unsheltered pools experience wind speeds above 5 mph (10.5x0.5x1.25).

¹⁸⁷⁹ ASHRAE Handbook, Applications, 2019, Ch 6, Table 1

- losses
= 0.80¹⁸⁸⁰
- ESF_{cover, evap} = Energy Savings Factor of pool cover to insulate from evaporative heat loss
= 0.95¹⁸⁸¹
- 0.1 = Simplified empirically derived evaporation factor considering latent heat and air flow.¹⁸⁸² Assumes 1,000 BTU/lb of latent heat required to change water to vapor at surface water temperature and air velocity over water surface ranging from 10 to 30 fpm, (lb/hr ft² in. hg)
- 8.33 = Energy required (BTU) to heat one gallon of water by one degree Fahrenheit
- 3,412 = Conversion factor, one kWh equals 3,412 BTU

Cold Water Inlet Temperature (T_{main})

Supply water main temperatures vary according to climate, and are approximately equal to the annual average outdoor temperature plus 6°F.¹⁸⁸³ Supply main temperatures based on the annual outdoor temperature are shown below.

Climate Zone	Annual Average Outdoor Temperature (°F) ¹⁸⁸⁴	T _{main} (°F)
1 (Rockford)	49.2	55.2
2 (Chicago)	51.4	57.4
3 (Springfield)	53.0	59.0
4 (Belleville)	57.3	63.3
5 (Marion)	56.5	62.5

Saturation Vapor Pressure (P_w)

Lookup saturation vapor pressure taken at surface water temperature for indoor and outdoor pools from the table below, based on pool temperature.¹⁸⁸⁵

Pool Temperature, T _{pool} (°F)	P _w (in. Hg)
72	0.79
74	0.85
76	0.91
78	0.97
80	1.03
82	1.10
84	1.18

¹⁸⁸⁰ U.S. D.O.E., Swimming Pool Covers.

¹⁸⁸¹ National Plasterers Council, Effectiveness of Pool Covers to Reduce Evaporation from Swimming Pools, prepared by California Polytechnic State University, January 2016.

¹⁸⁸² Simplified constant presented in ASHRAE Handbook: HVAC Application 2019 Ch 6 based on empirically derived eqn (2) constants and ASHRAE’s variable assumptions

¹⁸⁸³ Burch, Jay and Christensen, Craig, “Towards Development of an Algorithm for Mains Water Temperature.” National Renewable Energy Laboratory.

¹⁸⁸⁴ Average annual outdoor temperatures taken from NCDC 1981-2010 climate normals. <https://www.ncdc.noaa.gov/cdo-web/datatools/normals>

¹⁸⁸⁵ ASHRAE Handbook: Fundamentals 2017, Ch 1 Psychrometrics, Table 3 Thermodynamic Properties of Water at Saturation

Ambient Air Temperature and Pressure (T_{amb} and P_{dp})

Indoor pools shall apply ambient air temperature from application based on facility set point temperature. Lookup saturation vapor pressure based on facility set point temperature and relative humidity (RH) from the table below, based on psychrometric analysis. Interpolation may be performed for indoor pool ambient temperatures not listed.

Indoor Pool Temperature, T_{amb} (°F)	Indoor Pool, P_{dp} (in. Hg)		
	RH 50%	RH 55%	RH 60%
72	0.40	0.44	0.47
74	0.42	0.47	0.51
76	0.45	0.50	0.54
78	0.48	0.53	0.58
80	0.52	0.56	0.62
82	0.55	0.61	0.66
84	0.59	0.65	0.71
86	0.63	0.69	0.75

For outdoor pools, lookup T_{amb} and P_{dp} from the table below based on location. Ambient temperature averages for outdoor pools apply a 4-month swimming season.

Climate Zone	Outdoor Pool Temperature T_{amb} (°F) ¹⁸⁸⁶	Outdoor Pool P_{dp} (in. Hg) ¹⁸⁸⁷
1 (Rockford)	69.6	0.52
2 (Chicago)	73.4	0.53
3 (Springfield)	72.9	0.58
4 (Belleville)	73.9	0.60
5 (Marion)	74.8	0.62

Fuel Switch Example

A gas pool heater is replaced with a heat pump pool heater at a single family home located near Chicago. The swimming season spans 4 months (2,904 hours) per year and the pool is left uncovered at night. The pool is 15 ft by 30 ft and has a volume of 17,600 gallons, and is sheltered from winds by the house and backyard trees. The pool temperature is maintained at 80°F. The replaced gas pool heater has an efficiency of 82% and the heat pump pool heater has an efficiency of 5.0 COP. Annual Electric Energy Savings, Summer Peak Coincident Demand Savings and Annual Fossil Fuel Energy Savings are calculated as below.

$$\Delta kWh = (BTU_{Surface} + BTU_{Reheat} + BTU_{Evap}) / 3,412 \times (F_{elec, baseline} / COP_{baseline} - 1 / COP_{pe})$$

$$\Delta kW = \Delta kWh / hrs \times CF$$

$$\Delta MMBtu = (BTU_{Surface} + BTU_{Reheat} + BTU_{Evap}) / 1,000,000 \times F_{fuel, baseline} / E_{t, baseline}$$

where:

¹⁸⁸⁶ DOE Weather Data, TMY3 (Typical Meteorological Year), developed by NREL. Adjusted to apply to outside air temperature from June 1 to September 30 in each climate zone.

¹⁸⁸⁷ DOE Weather Data, TMY3 (Typical Meteorological Year), developed by NREL. Saturation pressure at dew point calculated as a function of dew point and atmospheric pressure. Values averaged from June 1 to September 30 in each climate zone.

$$BTUSurface=(T_{pool}-T_{amb})\times A_{pool}\times U\times [hrs-(hrs_{cover}\times ESF_{cover,surface})]$$

$$BTUReheat=V_{pool}\times 8.33\times (T_{pool}-T_{main})\times FReheat$$

$$BTUEvap=0.1\times AF\times A_{pool}\times (P\omega-Pdp)\times (T_{pool}-T_{main})\times [hrs-(hrs_{cover}\times ESF_{cover,evap})]$$

$T_{pool} = 80$, from application

$T_{amb} = 73.4$, from Ambient Air Temperature and Pressure section based on location from application

$A_{pool} = \text{width} \times \text{length} = 15' \times 30' = 450$ square feet

Width and length from application

$U = 5.3$, from Summary of Variables and Data Sources table based on conditions from application

$hrs = 2,904$, from 121 day season or application

$hrs_{cover} = 0$, from application

$ESF_{cover,surface} = 0.8$, from Summary of Variables and Data Sources table

$V_{pool} = 17,600$, from application

$T_{main} = 57.4$, from Cold Water Inlet Temperature table based on location from application

$FReheat = 1$, from Summary of Variables and Data Sources table

$AF = 0.5$, from Summary of Variables and Data Sources table

$P\omega = 1.03$, from Saturation Vapor Pressure section based on pool temperature from application

$Pdp = 0.53$, from Ambient Air Temperature and Pressure section based on location from application

$ESF_{cover,evap} = 0.95$, from Summary of Variables and Data Sources table

$Felec,baseline = 0$, from Summary of Variables and Data Sources table based on application

$CO_{Pee} = 5.0$, from application

$CF = 0$, from Summary of Variables and Data Sources table based on application

$F_{fuel,baseline} = 1$, from Summary of Variables and Data Sources table based on application

$Et,baseline = 0.82$, from application

$$BTUSurface=(80-73.4)\times 450\times 5.3\times [2,904-(0)]=45,711,864 \text{ Btu}$$

$$BTUReheat=17,600\times 8.33\times (80-57.4)\times 1=3,313,341 \text{ Btu}$$

$$BTUEvap=0.1\times 0.5\times 450\times (1.03-0.53)\times (80-57.4)\times [2,904-(0)]=738,342 \text{ Btu}$$

$$\Delta kWh=(45,711,864+3,313,341+738,342)/3,412\times (0-1/5)=-2,917 \text{ kWh}$$

= -10.0 Δ MMBtu of Electric Site Energy

$$\Delta kW=-2,917\times 0=0 \text{ kW}$$

$$\Delta MMBtu=(45,711,864+3,313,341+738,342)/1,000,000\times 1/0.82=60.7 \Delta MMBtu \text{ of Natural Gas Site Energy}$$

Converted to Therms this is 607

$$\Delta MMBtu \text{ Site Energy Savings is } = 60.7 \text{ MMBtu} - 10.0 \text{ MMBtu} = 50.7 \text{ MMBtu}$$

SUMMER COINCIDENT PEAK DEMAND SAVINGS

$$\Delta kW = \frac{(BTU_{Surface} + BTU_{Reheat} + BTU_{Evap})}{3,412} * \left(\frac{F_{elec,baseline}}{COP_{baseline}} - \frac{1}{COP_{ee}} \right) * \frac{CF}{hrs}$$

Where CF value depends on location of pool

CF = 0 for outdoor pools

CF = 0.8 for indoor pools

FOSSIL FUEL SAVINGS

N/A

WATER AND OTHER NON-ENERGY IMPACT DESCRIPTIONS AND CALCULATION

N/A

DEEMED O&M COST ADJUSTMENT CALCULATION

N/A

MEASURE CODE: RS-MS-C-HPPH-V01-230101

REVIEW DEADLINE: 1/1/2026

5.7.5 Tree Planting

DESCRIPTION

This measure describes savings from a program where utility sponsored staff work with homeowners or building operators to determine the appropriate location and ultimately plant trees to maximize HVAC savings.

How measure saves energy:

1. Trees when in full foliage block direct sunlight onto exterior surfaces of residences, and in the cooling season reduce energy use. Primary effects are reduced insulation into residences through windows. Secondary effects are reduced wall and roof temperatures which reduce conduction through walls and roofs into residences.
2. Trees when in full foliage block winds and associated infiltration into residences. This saves both heating and cooling energy since outdoor air is generally either hotter or colder than the desired indoor temperature.
3. Because trees have differential winter impacts, based on whether they are leaf-retaining (Coniferous) or leaf-shedding (Deciduous), there are significantly differential effects of tree types for each facing wall of a residence. Therefore, eligibility requirements for types of trees planted on specific residence wall faces have been set to maximize savings and minimize losses due to trees.
4. Trees must provide shading to at least the 3rd story of a home in the cooling season and eligibility therefore requires trees to be a minimum of 30 feet tall when fully mature.

Markets measure serves:

This measure provides benefits to single-family residences as well as multi-family residences. It provides benefits for all types of homes, from 1 story to 3 story residences. Trees must be planted within 30 feet of the walls of homes so that they provide shading during summer days when the sun is at a high angle.

Limitations to measure applicability:

This measure is inapplicable to residences that currently have trees shading the face where the trees are proposed to be added (that is, the face of the existing residence where the tree is proposed must currently be unshaded). Coniferous trees are ineligible on the East and South faces of residences because these trees block beneficial sunlight in the heating season, which reduces annual savings severely. Similarly, Deciduous trees are ineligible on North faces of residences because they lose their leaves in winter and therefore have a minimal wind-blocking effect on infiltration during prevailing NW and W winter winds; in addition, because they are on the North face, they provide attenuated benefits for summer cooling energy use.

This measure was developed to be applicable to the following program types: RF, NC. If applied to other program types, the measure savings should be verified.

DEFINITION OF EFFICIENT EQUIPMENT

Trees must be horticulturally defined as either leaf-retaining (e.g., Coniferous) or leaf-shedding (e.g., Deciduous). The eligibility of tree types are dependent on the orientation of the wall of the residence being shaded as follows:

1. On North-facing walls, only Coniferous trees (i.e., trees that retain leaves all year) are eligible.
2. On East- and South-facing walls, only Deciduous trees (i.e., trees that lose leaves in Fall) are eligible.
3. On West-facing walls, both deciduous and coniferous trees are eligible.
4. Trees must be minimum 30 ft tall when fully mature and have a lifetime of at least 20 years in Midwest climate.
5. Trees must be planted within 30 feet of the wall that they are shading and no closer than 20 feet apart.

DEFINITION OF BASELINE EQUIPMENT

Residence wall where trees are proposed to be planted currently must be fully or partially unshaded OR currently

be planted with “ineligible” trees that will be removed and replaced with “eligible” trees. If the residence wall currently is partially shaded, the proposed tree must be planted in front of the currently unshaded portion of the wall.

DEEMED LIFETIME OF EFFICIENT EQUIPMENT

Savings from tree planting take a number of years to be realized as significant growth is required before the shading makes a significant impact. The length of time before savings are fully achieved will be dependent on a number of factors including size of tree when planted, proximity to building and the speed of growth. This measure has been designed based on the assumption that savings would not be achieved for the first five years and would then be realized from year 6 and for a further 20 years.

However, in order to simplify the implementation of this measure, a reduced savings is claimed from year 1 and for an assumed measure life of 25 years, which results in an equivalent present value of lifetime savings. This results in a 79% multiplier¹⁸⁸⁸ applied to the calculated annual savings for the measure.

If there is reason to believe that the length of time before savings are achieved is significantly different to the 5 years assumed, an alternative multiplier can be applied.

DEEMED MEASURE COST

Use actual installed cost per tree planted.

LOADSHAPE

- Loadshape R08 - Residential Cooling
- Loadshape R09 - Residential Electric Space Heat
- Loadshape R10 - Residential Electric Heating and Cooling

COINCIDENCE FACTOR

The summer peak coincidence factor for cooling is provided in two different ways below. The first is used to estimate peak savings during the utility peak hour and is most indicative of actual peak benefits, and the second represents the *average* savings over the defined summer peak period, and is presented so that savings can be bid into PJM’s capacity market.

- CF_{SSP} = Summer System Peak Coincidence Factor for Central A/C (during utility peak hour)
= 68%¹⁸⁸⁹
- CF_{SSP} = Summer System Peak Coincidence Factor for Heat Pumps (during system peak hour)
= 72%¹⁸⁹⁰
- CF_{PJM} = PJM Summer Peak Coincidence Factor for Central A/C (average during PJM peak period)
= 46.6%¹⁸⁹¹

¹⁸⁸⁸ Assuming Real Discount Rate of 0.46%.

¹⁸⁸⁹ Based on metering of 24 homes with central AC during PY4 and PY5 in Ameren Illinois service territory.

¹⁸⁹⁰ Based on analysis of metering results from 24 heat pumps in Ameren Illinois service territory in PY5 coincident with AIC’s 2010 system peak; ‘Impact and Process Evaluation of Ameren Illinois Company’s Residential HVAC Program (PY5)’.

¹⁸⁹¹ Based on analysis of Itron eShape data for Missouri, calibrated to Illinois loads, supplied by Ameren. The average AC load over the PJM peak period (1-5pm, M-F, June through August) is divided by the maximum AC load during the year.

Algorithm

CALCULATION OF ENERGY SAVINGS

ELECTRIC ENERGY SAVINGS

$$\text{Total } \Delta\text{kWh} = (\Delta\text{kWh}_{\text{HeatingDirectSolar}} + \Delta\text{kWh}_{\text{CoolingDirectSolar}} + \Delta\text{kWh}_{\text{HeatingInfiltration}} + \Delta\text{kWh}_{\text{CoolingInfiltration}}) * (1 - \text{LMR}) * \text{NPVDiscount}$$

Where:

$\Delta\text{kWh}_{\text{HeatingDirectSolar}}$ = Annual heating savings due to reduction in Direct Solar Gain
 = #Trees * ThermsHeatingIncrease/Tree * 100,000 / 3,412 / ηHeat * %ElectricHeat

#_Trees = total number of eligible trees planted
 = actual number of eligible trees planted on any face of the residence

ThermsHeatingIncrease/Tree = net annual therms of heating increase per tree due to shading, based on the average annual savings of eligible trees planted on all faces of the residence
 = - 3.2 Therms/tree ¹⁸⁹²

100,000 = conversion of Therms to BTUs

3,412 = conversion BTUs to kWh

ηHeat = Efficiency of heating system
 = In order to account for the long-term aspect of this measure and the likely replacement of existing heating and cooling equipment during the lifetime of this measure, the following system efficiency assumptions should be used:

Efficiency Assumption	System Type	New Baseline Efficiency
ηHeat	Electric Resistance	1.0 COP
	Heat Pump (7.0HSPF2/3.413)*0.85	1.74 COP
	Furnace 80% AFUE * 0.85	68% AFUE
	Boiler	84% AFUE

%ElectricHeat = Percent of homes that have electric space heating
 = 100 % for Electric Resistance or Heat Pump
 = 0 % for Natural Gas

¹⁸⁹² Savings are based upon a modeling spreadsheet provided by Leidos – see ‘Shade Tree Energy Savings – REVISED.xlsx’. This analysis includes a large number of assumptions and therefore resultant savings were trued up against TRM assumptions of full cooling energy consumption to result in a percentage savings that was consistent with a number of reviewed studies (namely: Home Energy Magazine: “Shade Trees as a Demand-Side Resource”, Energy and Buildings: “Peak power and cooling energy savings of shade trees”, and Ecological Economics: “Energy Savings from tree shade”. These references can be found in the reference folder.)

= If unknown¹⁸⁹³, use the following table:

Utility	Location				
	Single Family	Single Family Low Income	Multi Family	Multi Family Low Income	Unknown
Ameren	18%	26%	38%	39%	29%
ComEd	14%	22%	43%	48%	21%
PGL	1.0%	1.5%	4.0%	2.8%	2.2%
NSG	1.3%	0.8%	32.5%	1.2%	3.3%
Nicor	1.3%	0.8%	32.5%	1.2%	3.3%
All DUs ¹⁸⁹⁴					26%

Note: If a measure is supported by a gas and electric utility through a joint program, and it is unknown whether the participant has a gas supply, the electric utility values in the table above should be used. If it is known that the participant has a gas supply, the values from the gas utility above should be applied.

$\Delta kWh_{CoolingDirectSolar}$

= Annual cooling savings due to reduction in Direct Solar Gain

$$= \#Trees * Ton-hrCoolingSaved/Tree * 12,000 / (1,000 * \eta_{Cool}) * \%Cool$$

Ton-hrCoolingSaved/Tree = Net annual Ton-hours of cooling saved per tree due to shading, based on the average annual savings of eligible trees planted on all faces of the residence

$$= 137.3 \text{ ton-hrs/year/tree}^{1895}$$

12,000

= conversion of ton-hours to BTUs

η_{Cool}

= Efficiency (SEER2) of Air Conditioning equipment (kBtu/kWh)

= In order to account for the long-term aspect of this measure and the likely replacement of existing heating and cooling equipment during the lifetime of this measure, the following system efficiency assumptions should be used:

Efficiency Assumption	System Type	New Baseline Efficiency
η_{Cool}	Central AC	12.4 SEER2
	Heat Pump	13.3 SEER2

$\%Cool$

= Percent of homes that have cooling

¹⁸⁹³ Based on the average % Natural Gas used for space heating in Unknown residential structure types across all utilities covered by the IL program. Residence types include: SF, SF LI, MF & MF LI. Utilities included: Ameren, ComEd, People’s Gas, Northshore Gas & Nicor. Data provided from 2016 Ameren Illinois Demand Side Management (DSM) Market Potential Study by Applied Energy Group, ComEd’s 2019 Baseline Survey on residential space heating share, and PY2022-2023 Implementation Contractors Data for People’s Gas, Northshore Gas & Nicor .

¹⁸⁹⁴ For the weighted average calculations, please see the Analysis file. PGL, NSG, Nicor & gas customers were assumed to follow the provided split. ComEd total customers, minus overlap with PGL,NSG & Nicor, therefore electric only homes. Ameren is total customers minus Nicor.

¹⁸⁹⁵ Savings are based upon a modeling spreadsheet provided by Leidos – see ‘Shade Tree Energy Savings – REVISED.xlsx’. This analysis includes a large number of assumptions and therefore resultant savings were trued up against TRM assumptions of full cooling energy consumption to result in a percentage savings that was consistent with a number of reviewed studies (namely: Home Energy Magazine: “Shade Trees as a Demand-Side Resource”, Energy and Buildings: “Peak power and cooling energy savings of shade trees”, and Ecological Economics: “Energy Savings from tree shade”. These references can be found in the reference folder.)

Central Cooling?	%Cool
Yes	100%
No	0%
Unknown (for use in program evaluation only) ¹⁸⁹⁶	66%

$\Delta kWh_{\text{HeatingInfiltration}}$ = Annual heating savings due to reduction in infiltration
 = #Trees * CFM50/sqft * Area/ N_heat * %Reduction_HeatingInfiltration/Tree * 60 * 24 * HDD60 * 0.018 / (COPHeating * 3,412) * %ElectricHeat

CFM50/sqft = Average CFM of infiltration per square foot of residence floor area based on 50 pascal pressure differential (This is a Customer Input of degree of leakage rate of house; Assumes the CFM50 leakage rates in the following table; assumes CFM50 leakage rates were based on a typical 2,250 sq. ft. residence.)

Shade Tree ECM Constants	CFM50/sqft	CFM50	Source
Leaky/Low Insulation	2.22	5,000 CFM at 50 pascal	Estimate for Leaky 2,250 sqft dwelling
Average/Average Insulation Or if Unknown	1.51	3,400 CFM at 50 pascal	Estimate for Average 2,250 sqft dwelling
Tight/High Insulation	1.00	2,250 CFM at 50 pascal	Estimate for Tight 2,250 sqft dwelling

Area = floor area of residence
 = actual

%Reduction_HeatingInfiltration/Tree = Average infiltration reduction per tree during heating season due to tree blocking wind, based on average annual savings of eligible trees planted on all faces of the residence.
 = 0.47% infiltration reduction per tree ¹⁸⁹⁷

N_heat = Conversion factor from leakage at 50 Pascal to leakage at natural conditions
 = Based on climate zone, building height and exposure level:¹⁸⁹⁸

Climate Zone (City based upon)	N_heat (by # of stories)			
	1	1.5	2	3
1 (Rockford)	23.8	21.1	19.3	17.1
2 (Chicago)	23.9	21.1	19.4	17.2
3 (Springfield)	24.2	21.5	19.7	17.4
4 (St Louis, MO)	25.4	22.5	20.7	18.3

¹⁸⁹⁶ Percentage of homes in Illinois that have central cooling from “Table HC7.9 Air Conditioning in Homes in Midwest Region, Divisions, and States, 2009” from Energy Information Administration, 2009 Residential Energy Consumption Survey

¹⁸⁹⁷ Savings are based upon a modeling spreadsheet provided by Leidos – see ‘Shade Tree Energy Savings – REVISED.xlsx’. This analysis includes a large number of assumptions and therefore resultant savings were trued up against TRM assumptions of full cooling energy consumption to result in a percentage savings that was consistent with a number of reviewed studies (namely: Home Energy Magazine: “Shade Trees as a Demand-Side Resource”, Energy and Buildings: “Peak power and cooling energy savings of shade trees”, and Ecological Economics: “Energy Savings from tree shade”. These references can be found in the reference folder.)

¹⁸⁹⁸ N-factor is used to convert 50-pascal blower door air flows to natural air flows and is dependent on geographic location and # of stories. These were developed by applying the LBNL infiltration model (see LBNL paper 21040, *Exegisis of Proposed ASHRAE Standard 119: Air Leakage Performance for Detached Single-Family Residential Buildings*; Sherman, 1986; page v-vi, Appendix page 7-9) to the reported wind speeds and outdoor temperatures provided by the NRDC 30 year climate normals. For more information see Bruce Harley, CLEARResult “Infiltration Factor Calculations Methodology.doc”.

Climate Zone (City based upon)	N_heat (by # of stories)			
	1	1.5	2	3
5 (Paducah, KY)	27.8	24.6	22.6	20.0

60 = conversion of ton-hours cooling to BTUs

24 = conversion of Watts to kWh

HDD = Heating Degree Days

= Dependent on location:¹⁸⁹⁹

Climate Zone (City based upon)	HDD 60
1 (Rockford)	5230
2 (Chicago)	4798
3 (Springfield)	4266
4 (Belleville)	3188
5 (Marion)	3390
Weighted Average ¹⁹⁰⁰	4631

0.018 = Specific Heat capacity of Air (BTU/Cu.Ft./F)

$\Delta kWh_{CoolingInfiltration}$ = Annual cooling savings due to reduction in infiltration

$$= \#Trees * CFM50/sqft * Area / N_{Cool} * \%_{ReductionCoolingInfiltration/Tree} * 60 * 24 * CDD65 * LM * 0.018 / (\eta_{Cool} * 1000) * \%_{Cool}$$

N_{cool} = Conversion factor from leakage at 50 Pascal to leakage at natural conditions

= Dependent on location and number of stories:¹⁹⁰¹

Climate Zone (City based upon)	N_cool (by # of stories)			
	1	1.5	2	3
1 (Rockford)	39.5	35.0	32.1	28.4
2 (Chicago)	38.9	34.4	31.6	28.0
3 (Springfield)	41.2	36.5	33.4	29.6
4 (St Louis, MO)	40.4	35.8	32.9	29.1
5 (Paducah, KY)	43.6	38.6	35.4	31.3

$\%Reduction_{CoolingInfiltration/Tree}$ = Average infiltration reduction per tree during cooling season due to tree blocking wind, based on average annual savings of

¹⁸⁹⁹ National Centers for Environmental Information (NCEI) Annual Normals, from 2006 - 2020, calculated with a base temp of 60°F, consistent with the findings of Belzer and Cort, Pacific Northwest National Laboratory in "Statistical Analysis of Historical State-Level Residential Energy Consumption Trends," 2004. There is a county mapping table in Volume 1, Section 3.7 providing the appropriate city to use for each county of Illinois.

¹⁹⁰⁰ Weighted based on number of occupied residential housing units in each zone.

¹⁹⁰¹ N-factor is used to convert 50-pascal blower door air flows to natural air flows and is dependent on geographic location and # of stories. These were developed by applying the LBNL infiltration model (see LBNL paper 21040, *Exegisis of Proposed ASHRAE Standard 119: Air Leakage Performance for Detached Single-Family Residential Buildings*; Sherman, 1986; page v-vi, Appendix page 7-9) to the reported wind speeds and outdoor temperatures provided by the NRDC 30 year climate normals. For more information see Bruce Harley, CLEARResult "Infiltration Factor Calculations Methodology.doc".

eligible trees planted on all faces of the residence.

= 2.26% infiltration reduction per tree ¹⁹⁰²

CDD

= Cooling Degree Days

= Dependent on location:¹⁹⁰³

Climate Zone (City based upon)	CDD 65
1 (Rockford)	877
2 (Chicago)	1047
3 (Springfield)	1183
4 (Belleville)	1641
5 (Marion)	1450
Weighted Average ¹⁹⁰⁴	1098

LM

= Latent Multiplier

= Multiplies the CDD dry bulb temperature difference by a factor that accounts for the additional energy needed to dehumidify air when in cooling mode

Climate Zone (City based upon)	LM
1 (Rockford)	3.3
2 (Chicago)	3.2
3 (Springfield)	3.7
4 (St Louis, MO)	3.6
5 (Paducah, KY)	3.7

LMR

= Lifetime Mortality Rate – i.e. assumed percentage of trees that do not go on to provide the savings characterized in this measure.

= 18% for single family and 39% for multi family¹⁹⁰⁵

NPVDiscount

= Multiplier to reduce annual savings claimed from year 1 to account for assumed length of time before savings are realized.

= 79%¹⁹⁰⁶

¹⁹⁰² Savings are based upon a modeling spreadsheet provided by Leidos – see ‘Shade Tree Energy Savings – REVISED.xlsx’. This analysis includes a large number of assumptions and therefore resultant savings were trued up against TRM assumptions of full cooling energy consumption to result in a percentage savings that was consistent with a number of reviewed studies (namely: Home Energy Magazine: “Shade Trees as a Demand-Side Resource”, Energy and Buildings: “Peak power and cooling energy savings of shade trees”, and Ecological Economics: “Energy Savings from tree shade”. These references can be found in the reference folder.)

¹⁹⁰³ National Centers for Environmental Information (NCEI) Annual Normals, from 2006 - 2020, calculated with a base temp of 65°F. There is a county mapping table Volume 1, Section 3.7 providing the appropriate city to use for each county of Illinois.

¹⁹⁰⁴ Weighted based on number of occupied residential housing units in each zone (US Census 2010).

¹⁹⁰⁵ Assumption based on McPherson, “Energy-Saving Potential of Trees in Chicago”, page 24.

¹⁹⁰⁶ Based on assumption that savings would not be realized for first 5 years and then continue for 20 years. Applying this multiplier and claiming savings from year one and for a measure life of 25 years results in equivalent NPV of lifetime savings, applying a Real Discount Rate of 0.46%. If reason to believe savings will be realized after a significantly different length of time, and alternative multiplier can be calculated.

For example: Assuming 5 eligible trees are planted around home with average leakage and Insulation Levels; 2,500 Sq. Ft. floor area in a 2 story Single Family Residence in Springfield with an Air Source Heat Pump with unknown efficiency.

$$\Delta kWh = (\Delta kWh_{\text{HeatingDirectSolar}} + \Delta kWh_{\text{CoolingDirectSolar}} + \Delta kWh_{\text{HeatingInfiltration}} + \Delta kWh_{\text{CoolingInfiltration}}) * (1 - \text{LMR}) * \text{NPVDiscount}$$

$$\begin{aligned} \Delta kWh_{\text{HeatingDirectSolar}} &= \#Trees * \text{ThermsHeatingIncreased/Tree} * 100,000 / 3,412 / \eta_{\text{Heat}} * \%ElectricHeat \\ &= 5 * -3.2 * 100,000 / 3,412 / 2.04 * 100\% \\ &= -230 \text{ kWh} \end{aligned}$$

$$\begin{aligned} \Delta kWh_{\text{CoolingDirectSolar}} &= \#Trees * \text{Ton-hrCoolingSaved/Tree} * 12,000 / (1,000 * \eta_{\text{Cool}}) * \%Cool \\ &= 5 * 137.3 * 12,000 / (1,000 * 14) * 100\% \\ &= 588 \text{ kWh} \end{aligned}$$

$$\begin{aligned} \Delta kWh_{\text{HeatingInfiltration}} &= \#Trees * \text{CFM50/sqft} * \text{Area} / N_{\text{Heat}} * \%Reduction_{\text{HeatingInfiltration}} / \text{Tree} * 60 * 24 * \\ &\quad \text{HDD60} * 0.018 / (\text{COP}_{\text{Heating}} * 3,412) * \%ElectricHeat \\ &= 5 * 1.51 * 2,500 / 19.7 * 0.47\% * 60 * 24 * 4,266 * 0.018 / (2.04 * 3,412) * 100\% \\ &= 72 \text{ kWh} \end{aligned}$$

$$\begin{aligned} \Delta kWh_{\text{CoolingInfiltration}} &= \#Trees * \text{CFM50/sqft} * \text{Area} / N_{\text{Cool}} * \%Reduction_{\text{CoolingInfiltration}} / \text{Tree} * 60 * \\ &\quad 24 * \text{CDD65} * \text{LM} * 0.018 / (\eta_{\text{Cool}} * 1000) * \%Cool \\ &= 5 * 1.51 * 2,500 / 33.4 * 2.26\% * 60 * 24 * 1,183 * 3.7 * 0.018 / (14 * 1,000) * 100\% \\ &= 104 \text{ kWh} \end{aligned}$$

$$\begin{aligned} \Delta kWh &= (-230 + 588 + 72 + 104) * (1 - 0.18) * 0.79 \\ &= 345 \text{ kWh (69 kWh per tree)} \end{aligned}$$

SUMMER COINCIDENT PEAK DEMAND SAVINGS

$$\Delta kW = kWh_{\text{Cool}} / \text{FLH}_{\text{Cooling}} * \text{CF} * (1 - \text{LMR}) * \text{NPVDiscount}$$

Where:

- kWh_{Cool} = Total cooling kWh savings from measure
= $\Delta kWh_{\text{CoolingDirectSolar}} + \Delta kWh_{\text{CoolingInfiltration}}$
- $\text{FLH}_{\text{cooling}}$ = Full load hours of air conditioning
= Dependent on location:¹⁹⁰⁷

¹⁹⁰⁷ Full load hours for Chicago, Moline and Rockford are provided in “Final Evaluation Report: Central Air Conditioning Efficiency Services (CACES), 2010, Navigant Consulting”, p.33. An average FLH/Cooling Degree Day (from NCDC) ratio was calculated for these locations and applied to the CDD of the other locations in order to estimate FLH. There is a county mapping table in Volume 1, Section 3.7 providing the appropriate city to use for each county of Illinois. During update cycle for version

Climate Zone (City based upon)	Single Family	Multifamily
1 (Rockford)	547	499
2 (Chicago)	709	629
3 (Springfield)	779	707
4 (Belleville)	1082	982
5 (Marion)	956	868
Weighted Average ¹⁹⁰⁸		
ComEd	676	603
Ameren	875	791
Statewide	731	655

Use Multifamily if: Building meets utility’s definition for multifamily and HVAC system serves single unit. For residential sized systems serving 2 or more units, assume single family hours.

- CF_{SSP} = Summer System Peak Coincidence Factor for Central A/C (during system peak hour)
= 68%¹⁹⁰⁹
- CF_{SSP} = Summer System Peak Coincidence Factor for Heat Pumps (during system peak hour)
= 72%¹⁹¹⁰
- CF_{PJM} = PJM Summer Peak Coincidence Factor for Central A/C (average during peak period)
= 46.6%¹⁹¹¹

For example, using example from above and CF_{SSP} for heat pumps:

$$\begin{aligned} \Delta kW &= kWh_{Cool} / FLH_{Cooling} * CF * (1 - LMR) * NPVDiscount \\ kWh_{Cool} &= 588 + 104 \\ &= 692 \\ \Delta kW &= 692 / 711 * 0.72 * (1-0.18) * 0.79 \\ &= 0.454 \end{aligned}$$

FOSSIL FUEL SAVINGS

$$\Delta Therms = (\Delta Therms_{HeatingDirectSolar} + \Delta Therms_{HeatingInfiltration}) * (1 - LMR) * NPVDiscount$$

Where:

$$\begin{aligned} \Delta Therms_{HeatingDirectSolar} &= \text{Annual therm savings due to reduction in direct solar gain} \\ &= \#_Trees * ThermsHeatingIncreased/Tree / \eta_{Heat} * \%FossilHeat \end{aligned}$$

v.12, applied percent change of CDD65, NCEI Annual Normals from 30 yr data set (1981-2010) to more recent 15 yr data (2006-2020) to all FLHcool values.

¹⁹⁰⁸ Weighting for Ameren is based on electric accounts in each of the cooling zones. Weighting for ComEd and Statewide average is based on number of occupied residential housing units in each zone. ComEd is weighted average of Zones 1-2. Alternative program-weighted assumptions can be used if appropriate.

¹⁹⁰⁹ Based on metering of 24 homes with central AC during PY4 and PY5 in Ameren Illinois service territory.

¹⁹¹⁰ Based on analysis of metering results from 24 heat pumps in Ameren Illinois service territory in PY5 coincident with AIC’s 2010 system peak; ‘Impact and Process Evaluation of Ameren Illinois Company’s Residential HVAC Program (PY5)’.

¹⁹¹¹ Based on analysis of Itron eShape data for Missouri, calibrated to Illinois loads, supplied by Ameren. The average AC load over the PJM peak period (1-5pm, M-F, June through August) is divided by the maximum AC load during the year.

ThermsHeatingIncreased/Tree = Net annual therms of heating saved per tree due to shading and infiltration effects, based on the average annual savings of eligible trees planted on all faces of the residence.

= -3.2 Therms/Tree

η_{Heat} = as defined above

%FossilHeat = Percent of homes that have fossil fuel space heating

= 100 % for Fossil fuel

= 0 % for Electric Resistance or Heat Pump

= If unknown¹⁹¹², use the following table:

Utility	Location				
	Single Family	Single Family Low Income	Multi Family	Multi Family Low Income	Unknown
Ameren	82%	74%	62%	61%	71%
ComEd	86%	78%	57%	52%	79%
PGL	98.9%	98.5%	96.0%	96.9%	97.7%
NSG	98.3%	99.2%	67.5%	98.8%	96.6%
Nicor	98.3%	99.2%	67.5%	98.8%	96.6%
All DUs¹⁹¹³					74%

Note: If a measure is supported by a gas and electric utility through a joint program, and it is unknown whether the participant has a gas supply, the electric utility values in the table above should be used. If it is known that the participant has a gas supply, the values from the gas utility above should be applied.

$\Delta Therms_{HeatingInfiltration}$ = Annual therm savings due to reduction in infiltration

= #Trees * CFM50/SqFt * Area/ N_Heat * %_ReductionHeatingInfiltration/Tree * 60 * 24 * HDD60 * 0.018 / (η_{Heat} * 100,000)

¹⁹¹² Based on the average % Natural Gas used for space heating in Unknown residential structure types across all utilities covered by the IL program. Residence types include: SF, SF LI, MF & MF LI. Utilities included: Ameren, ComEd, People’s Gas, Northshore Gas & Nicor. Data provided from 2016 Ameren Illinois Demand Side Management (DSM) Market Potential Study by Applied Energy Group, ComEd’s 2019 Baseline Survey on residential space heating share, and PY2022-2023 Implementation Contractors Data for People’s Gas, Northshore Gas & Nicor .

¹⁹¹³ For the weighted average calculations, please see the Analysis file. PGL, NSG, Nicor & gas customers were assumed to follow the provided split. ComEd total customers, minus overlap with PGL,NSG & Nicor, therefore gas only homes. Ameren is total customers minus Nicor.

For example: Assuming 5 eligible trees are planted around home with average leakage and Insulation Levels; 2,500 Sq. Ft. floor area in a 2 story Single Family Residence in Springfield with furnace with system efficiency of 68%.

$$\Delta\text{Therms} = (\Delta\text{Therms}_{\text{HeatingDirectSolar}} + \Delta\text{Therms}_{\text{HeatingInfiltration}}) * (1 - \text{LMR}) * \text{NPVDiscount}$$

$$\begin{aligned} \Delta\text{Therms}_{\text{HeatingDirectSolar}} &= \# \text{Trees} * \text{ThermsHeatingIncreased/Tree} / \eta_{\text{Heat}} * \% \text{FossilHeat} \\ &= 5 * -3.2 / 0.68 * 100\% \\ &= -23.5 \text{ Therms} \end{aligned}$$

$$\begin{aligned} \Delta\text{Therms}_{\text{HeatingInfiltration}} &= \# \text{Trees} * \text{CFM50/SqFt} * \text{Area} / \text{N}_{\text{Heat}} * \% \text{ReductionHeatingInfiltration/Tree} * 60 \\ &\quad * 24 * \text{HDD60} * 0.018 / (\eta_{\text{Heat}} * 100,000) \\ &= 5 * 1.51 * 2,500 / 19.7 * 0.47\% * 60 * 24 * 4,266 * 0.018 / (0.68 * 100,000) * 100\% \\ &= 7.3 \text{ Therms} \end{aligned}$$

$$\begin{aligned} \Delta\text{Therms} &= (-23.5 + 7.3) * (1 - 0.18) * 0.79 \\ &= -10.5 \text{ Therms} \end{aligned}$$

WATER AND OTHER NON-ENERGY IMPACT DESCRIPTIONS AND CALCULATION

n/a

DEEMED O&M COST ADJUSTMENT CALCULATION

n/a

MEASURE CODE: RS-HVC-TREE-V03-250101

REVIEW DEADLINE: 1/1/2029

2025 Illinois Statewide Technical Reference Manual for Energy Efficiency

Version 13.0

Volume 4: Cross-Cutting Measures and Attachments

FINAL

September 20, 2024

Effective:

January 1, 2025

Table of Contents

VOLUME 1: OVERVIEW AND USER GUIDE

VOLUME 2: COMMERCIAL AND INDUSTRIAL MEASURES

VOLUME 3: RESIDENTIAL MEASURES

VOLUME 4: CROSS-CUTTING MEASURES AND ATTACHMENTS

6	CROSS-CUTTING MEASURES.....	6
6.1	Behavior.....	6
6.1.1	Adjustments to Behavior Savings to Account for Persistence.....	6
6.2	System Wide.....	20
6.2.1	Voltage Optimization.....	20
6.3	Purchasing Tools.....	30
6.3.1	Efficient Choice Tool.....	30
	ATTACHMENT A: ILLINOIS STATEWIDE NET-TO-GROSS METHODOLOGIES.....	34
	ATTACHMENT B: EFFECTIVE USEFUL LIFE FOR CUSTOM MEASURE GUIDELINES.....	120
	ATTACHMENT C: FRAMEWORK FOR COUNTING MARKET TRANSFORMATION SAVINGS IN ILLINOIS	128
1	MARKET TRANSFORMATION CONTEXT.....	128
1.1	Market Transformation Definition.....	128
1.2	Market Transformation and Resource Acquisition.....	128
1.3	Market Transformation and Attribution.....	130
1.4	What Makes an MT Initiative Recognizable?.....	131
2	MARKET TRANSFORMATION ENERGY SAVINGS AND EVALUATION	131
2.1	Theory-based Evaluation.....	132
2.1.1	Market Progress Evaluation Reports.....	132
2.2	Energy Savings Framework.....	133
2.2.1	Data Sources.....	133
2.2.2	Factors in Estimating MT Savings	134
2.2.3	Estimating Total Market Units.....	135
2.2.4	Estimating Total Market Savings	135
2.2.5	The Role of Natural Market Baseline and Attribution.....	136
2.2.6	Natural Market Baseline Units	137
2.3	Reviewing Natural Market Baseline Over Time	138
2.4	Accounting for RA Savings	140
2.5	Allocating Energy Savings to Individual Utility Sponsors	141
2.6	Estimating Savings Post Active-Market Engagement in Markets without Codes or Standards as an Endpoint	142
2.6.1	Duration of Savings Post Active Market Engagement in Markets without Codes or Standards as an Endpoint	142

2.7	Energy Codes and Appliance Standards	143
2.7.1	Additional Considerations for Savings from Codes and Standards	144
2.8	Energy Savings from Enhanced Energy Code Compliance Activities	145
2.8.1	Duration of Enhanced Energy Code Compliance Savings	146
2.9	Uncertainty and Risk in MT Savings Estimates	147
2.10	Market Transformation Savings Protocol Process Recommendation	147
2.11	Market Transformation Program Design, Savings Protocol and Evaluation Plan Documentation	147
3	APPENDICES	148
3.1	Appendix A: MT Initiative Business Plan Outline	148
3.2	Appendix B: Glossary of Terms	149
3.3	Appendix C: References	150

Table of Figures

Attachment A

Figure 2-1. Example - Types of Spillover and Methods for Assessment41
 Figure 3-1. Core Free Ridership Algorithm45
 Figure 3-2. C&I New Construction Protocol.....55
 Figure 3-3. Study-Based Free Ridership—Overview58
 Figure 3-4. Study-Based Free Ridership—No-Program FR Score Option #158
 Figure 3-5. Study-Based Free Ridership—No-Program FR Score Option #259
 Figure 4-1. NPSO Question Logic67
 Figure 4-2. Appliance Retirement Scenarios71
 Figure 4-3. Residential Upstream Lighting Free Ridership via In-Store Intercept.....74
 Figure 4-4. Residential Upstream Lighting Participant Spillover Determination76
 Figure 4-5. Residential Upstream Lighting Nonparticipant Spillover Determination78
 Figure 4-6. Residential Prescriptive Rebate (With No Audit) Free Ridership80
 Figure 4-7. Single-Family Home Energy Audit Free Ridership—No Cost Measures83
 Figure 4-8. Single-Family Home Energy Audit Free Ridership--Discounted Measures83
 Figure 4-9. Multifamily Free Ridership—Non-CFL/Non-LED Measures86
 Figure 4-10. Multifamily Free Ridership for Property Managers—CFL/LED Measures86
 Figure 4-11. Energy Saving Kits and Elementary Education Free Ridership88
 Figure 4-12. Residential New Construction Free Ridership90

Attachment C

Figure 1. Examples of Potential MT Activities Under a “Theory Umbrella”129
 Figure 2. Framework for MT Savings135
 Figure 3. Accounting for RA and MT Program Savings141
 Figure 4. The Effect of Energy Code Adoption144
 Figure 5. Savings from Enhancing Energy Code Compliance146

Table of Tables

Attachment A

Table 1-1. ICC Energy Efficiency Dockets34
 Table 2-1. Definitions.....38
 Table 3-1. Commercial, Industrial, and Public Sector Programs.....42
 Table 4-1. Residential and Low Income Programs.....62
 Table 4-2. Estimation of Respondents’ NPSO Savings67
 Table 4-3. Calculation of Total NPSO Generated68
 Table 4-4. Net Savings Example for a Sample Population*72
 Table 4-8. IECC 2015 Building Energy Code93
 Table 5-1. Example Triangulation Weighting Approach95
 Table 5-3. NTG Summary for Consumption Data Analysis100

Attachment B

Table 1-3. Non-Residential Custom Measure End-Use Categories, Subcategories and Effective Useful Life Values....120
 Table 1-4. Residential Custom Measure End-Use Categories, Subcategories and Effective Useful Life Values 124

Attachment C

Table 1. Comparing Resource Acquisition Programs and Market Transformation Initiatives.....129

Table 2. Summary of Market Transformation Program Supporting Documents 148

6 Cross-Cutting Measures

6.1 Behavior

6.1.1 Adjustments to Behavior Savings to Account for Persistence

DESCRIPTION

Energy efficiency program administrators are increasingly including behavior programs as part of their portfolios. These programs are characterized by various kinds of outreach, education, and customer engagement designed to motivate increases in conservation and energy management behaviors, and most commonly include participant specific energy usage information. Savings impacts are evaluated by ex-post billing analysis comparing consumption before and after (or with and without) program intervention, and require M&V methods that include customer specific energy usage regression analysis and randomized controlled trial (RCT) experimental designs, among others (see Behavioral protocol set forth in the IL-TRM Attachment A: Illinois Statewide Net-to-Gross Methodologies for more information). As such, initial calculation of savings is treated as a custom protocol.¹

An important issue for many stakeholders is whether energy savings from behavior programs continue over time (i.e., whether they persist beyond the initial program year). Behavior programs have now been delivered for a number of years in many jurisdictions. The weight of evaluation evidence indicates that the energy-saving behaviors influenced through at least some types of these programs can persist beyond the initial period of program intervention, even without continued program participation.² This post-treatment savings persistence has implications for calculations of first-year savings, measure life, and cost-effectiveness testing. Accounting for persistence will yield savings and cost-effectiveness estimates that more accurately reflect the true benefits of these programs. Because annual goals are based on first-year savings, programs should count, and only count, savings attributable to first-year spending. The effect of persistence of savings from such spending beyond the first year should be included in any lifetime savings calculations (including cumulative persistent annual savings) and cost effectiveness testing.

The protocol below was developed to outline the adjustments that should be made to account for the persistence of savings beyond the year of program delivery. This general protocol is applicable to behavior programs of any type, delivered to residential or C&I customers, that have evaluated evidence of program persistence. However, the deemed persistence values and measure life in this version of the protocol are specific to residential home energy reports (HERs)-type programs only.³ Evaluations in Illinois and elsewhere have shown that at least some of the savings from residential HERs-type behavior programs can persist into the first several years following discontinuation of program delivery, though on-going savings levels decay over time.⁴ For residential RCT programs evaluated to date, savings have been shown to persist for at least two years and as much as eight years following program delivery,⁵ and industry expectations are that savings may persist beyond that. For any other program type,

¹ The protocol outlined here assumes that adjustments to remove the effects of savings from program lift (participation in other utility programs), including legacy uplift, to account for move-outs and opt-outs, to normalize for effects of weather, and any other appropriate adjustments, have been made as part of the custom calculation of savings – this final savings value is referred to as “Measured Savings” in the calculations below.

² Long-Run Savings and Cost-Effectiveness of Home Energy Reports Programs, Cadmus, October 2014. Also see additional sources in the REFERENCE TABLES section below.

³ Residential HERs-type programs: programs that regularly deliver home energy reports to residential customers through direct mail or email channels using a random control trial (RCT) experimental design. At a minimum, the reports include customer specific usage information used for a comparison to similar households and individualized energy savings tips.

⁴ See REFERENCE TABLES below for sources.

⁵ Long-Run Savings and Cost-Effectiveness of Home Energy Reports Programs, Cadmus, October 2014. Also see additional sources in the REFERENCE TABLE below. Given the variable characteristics of persistence studies available, we acknowledge that using an average of these studies by fuel type may be the best approximation of persistence rates. However, moving forward, the TAC will incorporate additional study values and develop the most appropriate persistence factors, taking into account when possible participant characteristics, such as the duration of exposure, the frequency of reports, baseline usage, as well as the amount of time that has persisted since receiving their final report, and the shape of the persistence curve.

persistence factors and years of persistence will only be deemed for application once supportable assumptions for persistence exist as measured by multi-year, rigorous evaluation studies.

Evaluations of residential HERs-type programs calculate a custom value on an annual basis to estimate yearly savings which is the initial input value for application of this persistence protocol. Evaluators typically use a regression analysis to estimate program effects. These regression analyses provide what is called an average treatment effect (ATE) estimate of program savings. The ATE approach takes advantage of the presence of a randomly assigned control group for each cohort that received reports in the service territory. These regressions use various methods to account for household-specific usage patterns.⁶ Because of the experimental design, we can assume that the treatment and control groups experienced similar historical, political, economic, and other events that had comparable effects on their energy use. Moreover, because these groups experienced generally similar weather conditions, it is not necessary to measure or include weather in the RCT model specification to calculate initial annual savings related to the program.

However, in the case of comparing and summing savings year over year, exogenous factors, such as weather, are likely to make annual estimates non-equivalent. In particular, weather is likely to play an important role in driving behavioral effects, affecting savings magnitude (e.g., a constant percentage change in consumption will result in more cooling savings during a hotter-than-average summer), as well as savings rate (e.g., the percentage change in consumption is likely to be higher during hotter-than-average summers. As such, for this framework, evaluators will adjust for effects related to weather as part of the custom inputs to this protocol. Each evaluator will choose the most appropriate method for weather normalization. For example, one method would be to provide savings using a model specification that incorporates standard weather year inputs (e.g., HDD and CDD), to be used as the initial input into the calculation of annual savings, as well as inputs for cost effectiveness, as outlined below. This input will approximate average savings for a standard weather year based upon historical data.⁷ Adjusting savings to a standard weather year is consistent with how other weather-sensitive TRM measures are specified, and will remove weather risk from performance goals and cost-effectiveness testing.⁸

For any new programs (referred to as “waves” in the calculations below), their first year will be assumed to be Year 1 for that wave – that is, each wave is tracked separately, and savings are calculated separately using the approach outlined here. The assumptions and protocols outlined below will not be applied retrospectively to any utility programs.

Updates to persistence factors and prospective retention rates from future evaluations, once incorporated into the IL-TRM, will be used when available for calculation of annual savings values for applicable program years but will not be applied retrospectively to previous years’ savings calculations. This includes that when persistence factors and retention rates are changed, the evaluation will utilize the persistence factors and retention rates that were used to calculate claimed savings in previous years to subtract persistence savings from those years. For example, persistence factors changed between CY2021 and CY2022; in CY2021 the earlier persistence factors (based on a 5-year measure life) were used to claim savings from CY2021- CY2025, therefore in CY2022-CY2025 persisting savings from CY2021 should be subtracted based on those same persistence factors. Savings for CY2022 and forward would use the new persistence factors. The same logic applies for prospective retention rates. This avoids a situation where savings that have never been claimed are being subtracted as persisting (for example, avoiding the situation where in CY2018 the utility only got to claim 15% of savings for CY2022, but now in CY2022 we are going to subtract 37% of savings as persistence from CY2018).

⁶ For example, a linear fixed-effects regression (LFER) model includes a household-specific intercept to account for time invariant, household-level factors affecting energy use, and a post program regression (PPR) model uses energy use lags to account for household-specific usage in the year prior to the program.

⁷ In the future, this approach could be empirically tested by comparing actual savings calculated in future program years against standard weather year results, producing a ‘realization rate’ between planned and actual savings results. Standard weather years could potentially be enhanced to better reflect these differences.

⁸ We acknowledge that this approach is a proxy for estimating actual savings to allow for prospective calculation of lifetime savings. However, a substantial limitation to this approach is the issue of unobserved behavioral ramp-up that is likely to occur for future waves of participants.

As noted above, all other types of behavior programs other than residential HERs-type programs may use this adjustment protocol with appropriate persistence factors as follows. In the absence of supportable evidence for behavioral persistence for such other program types, persistence factors and measure life will not be deemed. Instead, program administrators may choose to propose and defend persistence factors and years of persistence to be used for such behavioral programs on a custom basis in concert with the independent evaluator and stakeholders,⁹ on the understanding that the evaluator should then plan to retrospectively assess persistence for these programs when feasible. However, these persistence factors will be subject to evaluation risk similar to any other custom evaluation parameter.

DETERMINATION OF EFFICIENT BEHAVIOR

Behavior programs focus primarily on reducing electricity and natural gas consumption through behavioral changes; this reduction is generally measured through ex-post billing analysis after program intervention. Specific energy conservation and management behaviors are not usually directly observable. The specific definition of the efficient case is part of the design of behavioral programs and is included as part of the custom saving protocol, which will include any adjustment necessary to remove effects of program-related investments in efficient equipment.

DETERMINATION OF BASELINE BEHAVIOR

The ideal baseline for behavior programs is the energy usage without the program intervention. Various types of experimental, quasi-experimental, and/or regression-based EM&V approaches are used to present statistically valid approximations to this without-program baseline.¹⁰ The specific definition of the baseline case is part of the design of behavioral programs and is included as part of the custom saving protocol.

DEEMED LIFETIME/PERSISTENCE OF SAVINGS

We assume here that positive savings for residential HERs-type behavior programs persist at some level for nine years beyond the initial treatment year for electric programs, giving a 10-year measure life, and for six years beyond the initial treatment year for gas programs, giving a seven-year measure life.¹¹ In the case of negative first-year savings, savings do not persist into the future. On-going persistent savings over those years are not equal, however; it is preferable that actual levels of ongoing savings should be calculated by future year as outlined below (see Application of Persistence for Prospective Calculations section below) to be used in cost effectiveness and lifetime savings calculations.¹² For other behavior program types without deemed measure lives and persistence factors, program administrators may choose to propose and defend years of persistence to be used on a custom basis in concert with the independent evaluator and stakeholders, on the understanding that the evaluator should then plan to retrospectively assess persistence for these programs when feasible. Alternatively, a deemed one-year measure life may be used if nothing defensible on measure life/persistence exists.

DEEMED MEASURE COST

It is assumed that most behavior changes in residential settings can be accomplished with homeowner labor only and without investment in new equipment; therefore, without evidence to the contrary, measure costs incurred by customers in such residential programs focused on motivating changes in customer behavior may be defined as \$0.¹³

⁹ Program Administrators may also choose to use a deemed one-year measure life in the absence of other evidence.

¹⁰ See the Illinois Behavioral protocol set forth in the IL-TRM Attachment A: IL-NTG Methods for more information concerning randomized control trials and quasi-experimental evaluation methods for non-randomized designs for behavior programs.

¹¹ Determined as a reasonable assumption by Illinois TAC members. This assumption should continue to be updated as additional research is conducted on these types of programs, and additional evaluation should be undertaken to assess the reasonableness of this assumption for Illinois-specific programs.

¹² This method of applying calculated values for future year benefits is preferred. Alternatively, an effective measure life can be calculated as Effective Measure Life = Total Discounted Lifetime Savings / First Year Savings.

¹³ Future evaluation of costs of behavior change is encouraged to help clarify this assumption. In addition, as noted earlier in this measure characterization, in order to ensure double counting of savings does not occur, the protocol outlined here assumes that adjustments to remove the effects of program lift have been made as part of the custom calculation of savings. In

Costs for C&I programs may include additional staffing, software purchases, etc. Cost for such programs is therefore program specific and is determined on a custom basis.

Costs incurred by Program Implementation Contractors to provide customer-specific information leading to behavior changes are considered study-based services as defined in the Illinois Energy Efficiency Policy Manual. Therefore, the full cost of these study-based services charged by the Program Implementation Contractor is the measure cost, because this is assumed to be the cost of the study-based service that would have been incurred by the Customer if the Customer were to have the study-based service performed in the absence of the efficiency Program.

LOADSHAPE AND COINCIDENCE FACTOR

While there is evidence from analysis of AMI data that the savings loadshape for residential HERs-type programs mirrors the whole-house electric energy load pattern, there are not yet enough data to develop a behavior-specific loadshape. Indications from several unpublished analyses¹⁴ show that these behavior savings occur in a general pattern most closely approximated by the Residential Electric Heating and Cooling Loadshape (R10) than any other current residential measure loadshape; this is therefore recommended as the most reasonable approximation for use until more-specific data are available. Loadshapes and coincidence factors will need to be determined for other types of behavior programs once sufficient data are in hand.

Algorithm

CALCULATION OF SAVINGS

Throughout these protocols, Year T refers to the current reporting year for which annual savings are being determined (treatment year).¹⁵

ELECTRIC ENERGY SAVINGS

The algorithm shown below for this measure was developed to calculate the annual persistence-adjusted electric savings in to be reported in year T after adjustment to account for the proportion of the measured savings for that program year that actually reflects any persistent savings from prior years’ program activities (Years T-1, T-2, T-3, etc.).¹⁶

$$\Delta kWh_{T \text{ Adjusted}} = \Delta kWh_{T \text{ Measured}} - \sum_{i=1}^n (\Delta kWh_{T-i \text{ Adjusted}} * RR^i * PFE_i)$$

Where:

$\Delta kWh_{x \text{ Adjusted}}$ = total program annual savings for year X after adjustments to account for persistence (calculated value)

$\Delta kWh_{x \text{ Measured}}$ = measured kWh savings: total program savings as determined from custom

a similar manner, given the savings accounted for by other utility programs are removed from the savings claims and cost effectiveness for the behavior program, the incremental costs associated with such utility program incentivized measures should also be excluded from the behavior program cost-effectiveness analysis, so as to help ensure double counting of costs does not occur in the utility portfolio cost-effectiveness analysis.

¹⁴ Based on communication from Mathias Bell based on (currently unpublished) studies done by Opower, Cadmus, and LBNL. Also see DTE Energy: Behavior Program Measures for Submission to 2015 MEMD - Year Three Energy Savings - Demand Savings. Energy Optimization, April 15, 2014. http://www.michigan.gov/documents/mpsc/memd_2015_453673_7.pdf

¹⁵ Calculation algorithms account for attrition of customers out of the service territory, as well as persistence decay. It has been noted that there may also be a need to adjust for cross-year effects of large differences in weather conditions or economic impacts. Custom savings inputs therefore are adjusted for standard year weather.

¹⁶ This calculation should be carried out separately for each “wave” of behavior programs, where a wave is defined as a newly launched program. For simplicity, any new wave is assumed to start at the beginning of a program year (Year 1) and may include multiple different treatment types such as usage groups, report frequency, etc. For example, any wave added after 2022 will be considered Year 1 in the year they are launched.

calculation/billing analysis of participants in program during year X (input value)¹⁷

RR = a wave-specific expected retention rate for the program^{18,19}

PFE_Z = Persistence factor, electric programs (deemed value)

= % savings that persist Z years after savings were initially measured

= use table below to select the appropriate value

n = number of additional years beyond first year of program delivery for which savings persist

= Illinois electric programs assumption = 9

Electric Persistence Factors²⁰

Program Type = Electric Residential HERs-type (RCT)		
Application Year	Persistence Factor	
	If ΔkWh _T Adjusted >= 0	Else
Program Year T (treatment year) - record 100% of adjusted savings (ΔkWh_{TAdjusted} above)	100%	100%
Percent adjusted savings from Year T activities that persist 1 year after year T = PFE ₁	78%	0%
Percent adjusted savings from Year T activities that persist 2 years after year T = PFE ₂	61%	0%

¹⁷ All appropriate adjustments to remove effects of participation in other utility programs, move-outs, opt-outs, to normalize for effects related to weather, and other adjustments as determined by the program experimental design, are assumed to have been made to result in this value for “measured savings”. This value has been adjusted for standard year weather terms.

¹⁸ This retention rate should be an historical average, based on multiple years of data, that applies for a given utility wave. The retention rate should be updated on a regular basis (for example, with the program planning cycles) to make sure it remains reflective of current program and economic conditions. Evaluators will decide for each wave what population the retention rate should be based on (for example: all residential customers; the entire population eligible for the program; the current program population). In making this decision, evaluators should consider data availability, how long a wave has been in the program, the customer makeup of the wave, and other factors as needed.

¹⁹ It is possible that some savings related to behavioral programs persist even after participants move and are therefore dropped from the program. Such persistent savings could potentially occur in two ways. First, some proportion of these potential savings likely comes from efficient measures installed on the premises and not otherwise identified through other direct program participation; this component of saving could persist even under new building ownership. Second, participants who move might continue behavior changes that save energy even in a new setting; this could continue to provide savings to the program administrator if the move was within the same utility territory. As of this time, no definitive information exists as to the level of program savings related to installed measures vs. behavioral changes, making determination of these effects highly uncertain, and sufficient data may not exist to track individual customer moves. As such, this protocol assumes no persistent savings related to customers who move. Program administrators may choose to propose and defend a methodology to calculate persisting savings net of the existing RCT for the residual effects of move-outs on a custom basis in concert with the independent evaluator and stakeholders. Such a custom treatment should be based on defensible evaluation of the proportion of persisting savings from move-outs related to installed efficient measures vs. ongoing changes in behavior, utility-specific data on total customer moves within the utility territory, and appropriate management of customers who move with regard to future behavior program participation. Management of customers who move out, and the associated persisting savings of the households and premises, should not impede the ability of the program administrator to operate the program as an RCT and maintain or expand the program size (households in treatment, etc.). Such an adjustment will be subject to evaluation risk similar to any other custom evaluation parameter.

²⁰ See REFERENCE TABLES below for sources.

Program Type = Electric Residential HERs-type (RCT)		
Application Year	Persistence Factor	
	If ΔkWh_T Adjusted ≥ 0	Else
Percent adjusted savings from Year T activities that persist 3 years after year T = PFE ₃	47%	0%
Percent adjusted savings from Year T activities that persist 4 years after year T = PFE ₄	37%	0%
Percent adjusted savings from Year T activities that persist 5 years after year T = PFE ₅	29%	0%
Percent adjusted savings from Year T activities that persist 6 years after year T = PFE ₆	23%	0%
Percent adjusted savings from Year T activities that persist 7 years after year T = PFE ₇	18%	0%
Percent adjusted savings from Year T activities that persist 8 years after year T = PFE ₈	14%	0%
Percent adjusted savings from Year T activities that persist 9 years after year T = PFE ₉	11%	0%

Example of Adjusted Annual Savings Calculations:

Assume the following information on participation and measured savings for an electric HERs-type program for the following program years (all adjustments have been made to remove effects of program lift, weather, etc. within the custom savings calculations). Assume 2021 is the first year of the program/wave.

	Reporting Year						
	2021	2022	2023	2024	2025	2026	2027
Input data from program information and custom savings analysis							
# Participants (households)	120,000	109,000	103,000	99,000	94,000	90,000	88,000
kWh per participant (household)	200	250	245	250	250	265	265
kWh Measured savings (custom)	24,000,000	27,250,000	25,235,000	24,750,000	23,500,000	23,850,000	23,320,000

Expected Retention Rate of 95%

Calculation of Adjusted Annual Savings:

$$\Delta kWh_{2021 \text{ Adjusted}} = 24,000,000 \text{ kWh}$$

$$\begin{aligned} \Delta kWh_{2022 \text{ Adjusted}} &= 27,250,000 - (24,000,000 * 0.95 * 0.78) \\ &= 9,466,000 \text{ kWh} \end{aligned}$$

$$\begin{aligned} \Delta kWh_{2023 \text{ Adjusted}} &= 25,235,000 - (9,466,000 * 0.95 * 0.78) - (24,000,000 * 0.95^2 * 0.61) \\ &= 5,008,094 \text{ kWh} \end{aligned}$$

$$\begin{aligned} \Delta kWh_{2024 \text{ Adjusted}} &= 24,750,000 - (5,008,094 * 0.95 * 0.78) - (9,466,000 * 0.95^2 * 0.61) - (24,000,000 * 0.95^3 * 0.47) \\ &= 6,156,543 \text{ kWh} \end{aligned}$$

$$\begin{aligned} \Delta kWh_{2025 \text{ Adjusted}} &= 23,500,000 - (6,156,543 * 0.95 * 0.78) - (5,008,094 * 0.95^2 * 0.61) - (9,466,000 * 0.95^3 * 0.47) \\ &\quad - (24,000,000 * 0.95^4 * 0.37) \\ &= 5,133,637 \text{ kWh} \end{aligned}$$

$$\begin{aligned} \Delta kWh_{2026 \text{ Adjusted}} &= 23,850,000 - (5,133,637 * 0.95 * 0.78) - (6,156,543 * 0.95^2 * 0.61) - (5,008,094 * 0.95^3 * 0.47) \\ &\quad - (9,466,000 * 0.95^4 * 0.37) - (24,000,000 * 0.95^5 * 0.29) \\ &= 6,400,301 \text{ kWh} \end{aligned}$$

$$\begin{aligned} \Delta kWh_{2027 \text{ Adjusted}} &= 23,320,000 - (6,400,301 * 0.95 * 0.78) - (5,133,637 * 0.95^2 * 0.61) - (6,156,543 * 0.95^3 * 0.47) \\ &\quad - (5,008,094 * 0.95^4 * 0.37) - (9,466,000 * 0.95^5 * 0.29) \\ &\quad - (24,000,000 * 0.95^6 * 0.23) \\ &= 5,579,188 \text{ kWh} \end{aligned}$$

Continue for future years as appropriate.

Apply the same approach to calculate adjusted annual kW and Therms, using appropriate factors and lifetimes.

SUMMER COINCIDENT PEAK DEMAND SAVINGS

Coincident peak demand savings in year T should also be adjusted to account for persistence from previous years using a similar algorithm.²¹

If peak demand is measured directly by the custom savings analysis:

$$\Delta kW_{T \text{ Adjusted}} = \Delta kW_{T \text{ Measured}} - \sum_{i=1}^n (\Delta kW_{T-i \text{ Adjusted}} * RR^i * PFE_i)$$

Where:

²¹ While there are no current studies that evaluate the persistence of peak savings, without more-specific information on the actual behaviors undertaken by program participants and their corresponding peak savings, it seems reasonable to assume that peak savings will also persist in a similar pattern; both of the approaches given assume persistence in peak savings. Further evaluation should be undertaken to clarify this point and determine appropriate peak-specific persistence values.

$\Delta kW_X \text{ Adjusted}$ = total program demand savings for year X after adjustments to account for persistence (calculated value)

$\Delta kW_X \text{ Measured}$ = total program demand savings as determined from custom calculation /billing analysis of participants in program during year X (input value)²²

Other variables as defined above

If peak demand is not measured directly by the custom savings analysis, peak demand should be calculated as follows:

$$\Delta kW_{T \text{ Adjusted}} = (\Delta kWh_{T \text{ Adjusted Summer}} / \# \text{summer hours}) * \text{peak adjustment factor}$$

Where:

$\Delta kWh_{T \text{ Adjusted Summer}}$ = average adjusted electric energy savings (calculated above) for peak summer months

$$= \Delta kWh_{T \text{ Adjusted}} * 0.42 * (3/5)$$

$$= \Delta kWh_{T \text{ Adjusted}} * 0.25$$

Where:

0.42 = Summer Loadshape % for May – Sept

3/5 = proportion of May-Sept hours that fall in June, July, and Aug

summer hours = # hours in June, July, and Aug

$$= 8760 / 4$$

Where: 8760 = Hours per year

peak adjustment factor = adjustment for peak k/w over average kW for these hours

$$= 1.5^{23}$$

FOSSIL FUEL ENERGY SAVINGS

The algorithm shown below for this measure was developed to calculate the annual persistence-adjusted Therm savings in to be reported in year T after adjustment to account for the proportion of the measured savings for that program year that actually reflects any persistent savings from prior years' program activities (Years T-1, T-2, T-3, etc.).²⁴

$$\Delta \text{Therms}_{T \text{ Adjusted}} = \Delta \text{Therms}_{T \text{ Measured}} - \sum_{i=1}^n (\Delta \text{Therms}_{T-i \text{ Adjusted}} * RR^i * PFG_i)$$

Where:

$\Delta \text{Therms}_X \text{ Adjusted}$ = total program annual savings for year X after adjustments to account for persistence (calculated value)

$\Delta \text{Therms}_X \text{ Measured}$ = total program savings as determined from custom calculation/billing analysis

²² All appropriate adjustments to remove effects of participation in other utility programs, move-outs, opt-outs, to normalize for effects related to weather, and other adjustments as determined by the program experimental design, are assumed to have been made to result in this value for "measured savings". This value has been adjusted for standard year weather terms.

²³ Based on an approach used in Michigan that gives resulting values supported by evaluation claims. Also see DTE Energy: Behavior Program Measures for Submission to 2015 MEMD - Year Three Energy Savings - Demand Savings. Energy Optimization, April 15, 2014. http://www.michigan.gov/documents/mpsc/memd_2015_453673_7.pdf

²⁴ This calculation should be carried out separately for each "wave" of behavior programs, where a wave is defined as a newly launched program. For simplicity, any new wave is assumed to start at the beginning of a program year (Year 1) and may include multiple different treatment types such as usage groups, report frequency, etc.

of participants in program during year X (input value)²⁵

PFG_z = Persistence factor, gas programs (deemed value)
 = % savings that persist Z years after savings were initially measured
 = use table below to select the appropriate value

n = number of additional years beyond first year of program delivery for which savings persist
 = Illinois gas programs assumption = 6

Other variables as defined above

Gas Persistence Factors²⁶

Program Type = Gas Residential HERs-type (RCT)		
Application Year	Persistence Factor	
	If $\Delta Therm_{ST} Adjusted \geq 0$	Else
Program Year T (treatment year) - record 100% of adjusted savings ($\Delta Therm_{ST} Adjusted$ above)	100%	100%
Percent adjusted savings from Year T activities that persist 1 year after year T = PGE_1	70%	0%
Percent adjusted savings from Year T activities that persist 2 years after year T = PGE_2	49%	0%
Percent adjusted savings from Year T activities that persist 3 years after year T = PGE_3	34%	0%
Percent adjusted savings from Year T activities that persist 4 years after year T = PGE_4	24%	0%
Percent adjusted savings from Year T activities that persist 5 years after year T = PGE_5	17%	0%
Percent adjusted savings from Year T activities that persist 6 years after year T = PGE_6	12%	0%

APPLICATION OF PERSISTENCE FOR PROSPECTIVE CALCULATIONS

For determination of prospective savings related to programs delivered in year T (including cost-effectiveness, lifetime savings, and cumulative prospective annual savings (CPAS)), future years’ savings related to the current year activities should be recorded for this measure as savings for each specific year calculated using the table below – the current year plus 9 years of future persisting savings for electric programs, and the current year plus 6 years of future persisting savings for gas programs, in the case of positive first-year savings. Because of the

²⁵ All appropriate adjustments to remove effects of participation in other utility programs, move-outs, opt-outs, to normalize for effects related to weather, and other adjustments as determined by the program experimental design, are assumed to have been made to result in this value for “measured savings”. This value has been adjusted for standard year weather terms.

²⁶ See REFERENCE TABLES below for sources.

potentially confounding effects of differences in weather in future years, the savings inputs used ($\Delta kWh_{TAdjusted}$, $\Delta kW_{TAdjusted}$, $\Delta Therms_{TAdjusted}$) for these future-year savings calculations have been determined using weather normalized inputs. This input (to be provided by program evaluators) will approximate average savings for a standard weather year based upon historical data.²⁷ In the case of negative first-year savings, no savings will persist into future years.

Calculation of Future Years' Savings Related to Current Year Activities			
	Electric Programs		Gas Programs
	Electric Energy Savings	Peak Savings	Therm Savings
Program Year T: record 100% of adjusted annual savings as calculated above	$\Delta kWh_{TAdjusted}$	$\Delta kW_{TAdjusted}$	$\Delta Therms_{TAdjusted}$
Percent savings from Year T activities that persist 1 year after year T	$\Delta kWh_{TAdjusted} * PFE_1 * RR$	$\Delta kW_{TAdjusted} * PFE_1 * RR$	$\Delta Therms_{TAdjusted} * PFG_1 * RR$
Percent savings from Year T activities that persist 2 years after year T	$\Delta kWh_{TAdjusted} * PFE_2 * RR^2$	$\Delta kW_{TAdjusted} * PFE_2 * RR^2$	$\Delta Therms_{TAdjusted} * PFG_2 * RR^2$
Percent savings from Year T activities that persist 3 years after year T	$\Delta kWh_{TAdjusted} * PFE_3 * RR^3$	$\Delta kW_{TAdjusted} * PFE_3 * RR^3$	$\Delta Therms_{TAdjusted} * PFG_3 * RR^3$
Percent savings from Year T activities that persist 4 years after year T	$\Delta kWh_{TAdjusted} * PFE_4 * RR^4$	$\Delta kW_{TAdjusted} * PFE_4 * RR^4$	$\Delta Therms_{TAdjusted} * PFG_4 * RR^4$
Percent savings from Year T activities that persist 5 years after year T	$\Delta kWh_{TAdjusted} * PFE_5 * RR^5$	$\Delta kW_{TAdjusted} * PFE_5 * RR^5$	$\Delta Therms_{TAdjusted} * PFG_5 * RR^5$
Percent savings from Year T activities that persist 6 years after year T	$\Delta kWh_{TAdjusted} * PFE_6 * RR^6$	$\Delta kW_{TAdjusted} * PFE_6 * RR^6$	$\Delta Therms_{TAdjusted} * PFG_6 * RR^6$
Percent savings from Year T activities that persist 7 years after year T	$\Delta kWh_{TAdjusted} * PFE_7 * RR^7$	$\Delta kW_{TAdjusted} * PFE_7 * RR^7$	n/a
Percent savings from Year T activities that persist 8 years after year T	$\Delta kWh_{TAdjusted} * PFE_8 * RR^8$	$\Delta kW_{TAdjusted} * PFE_8 * RR^8$	n/a
Percent savings from Year T activities that persist 9 years after year T	$\Delta kWh_{TAdjusted} * PFE_9 * RR^9$	$\Delta kW_{TAdjusted} * PFE_9 * RR^9$	n/a

Where all variables are as defined above.

²⁷ In the future, this approach could be empirically tested by comparing actual savings calculated in future program years against standard weather year results, producing a 'realization rate' between planned and actual savings results. Standard weather years could potentially be enhanced to better reflect these differences.

Example of Calculation of Cost-effectiveness Inputs:

Assume the same information for an electric program as was used in the Example of Adjusted Annual Savings Calculations.

	Reporting Year T						
	2021	2022	2023	2024	2025	2026	2027
Annual Energy Savings = Adj. kWh savings (previously calculated) = $\Delta kWh_{TAdjusted}$	24,000,000	9,466,000	5,008,094	6,156,543	5,133,627	6,400,301	5,579,188
RR = 0.95							

Inputs for calculating cost effectiveness in 2021:

Cost-effectiveness benefit of 2021 savings in 2022 = $\Delta kWh_{2021 Adjusted} * PFE_1 * RR = 24,000,000 * 0.78 * 0.95 = 17,784,000$ kWh

Cost-effectiveness benefit of 2021 savings in 2023 = $\Delta kWh_{2021 Adjusted} * PFE_2 * RR^2 = 24,000,000 * 0.61 * 0.95^2 = 13,212,600$ kWh

Cost-effectiveness benefit of 2021 savings in 2024 = $\Delta kWh_{2021 Adjusted} * PFE_3 * RR^3 = 24,000,000 * 0.47 * 0.95^3 = 9,671,190$ kWh

Cost-effectiveness benefit of 2021 savings in 2025 = $\Delta kWh_{2021 Adjusted} * PFE_4 * RR^4 = 24,000,000 * 0.37 * 0.95^4 = 7,232,816$ kWh

Cost-effectiveness benefit of 2021 savings in 2026 = $\Delta kWh_{2021 Adjusted} * PFE_5 * RR^5 = 24,000,000 * 0.29 * 0.95^5 = 5,385,515$ kWh

Cost-effectiveness benefit of 2021 savings in 2027 = $\Delta kWh_{2021 Adjusted} * PFE_6 * RR^6 = 24,000,000 * 0.23 * 0.95^6 = 4,057,707$ kWh

Inputs for calculating cost effectiveness in 2022:

Cost-effectiveness benefit of 2022 savings in 2023 = $\Delta kWh_{2022 Adjusted} * PFE_1 * RR = 9,466,000 * 0.78 * 0.95 = 7,014,306$ kWh

Cost-effectiveness benefit of 2022 savings in 2024 = $\Delta kWh_{2022 Adjusted} * PFE_2 * RR^2 = 9,466,000 * 0.61 * 0.95^2 = 5,211,270$ kWh

Cost-effectiveness benefit of 2022 savings in 2025 = $\Delta kWh_{2022 Adjusted} * PFE_3 * RR^3 = 9,466,000 * 0.47 * 0.95^3 = 3,814,479$ kWh

Cost-effectiveness benefit of 2022 savings in 2026 = $\Delta kWh_{2022 Adjusted} * PFE_4 * RR^4 = 9,466,000 * 0.37 * 0.95^4 = 2,852,743$ kWh

Cost-effectiveness benefit of 2022 savings in 2027 = $\Delta kWh_{2022 Adjusted} * PFE_5 * RR^5 = 9,466,000 * 0.29 * 0.95^5 = 2,124,137$ kWh

Cost-effectiveness benefit of 2022 savings in 2028 = $\Delta kWh_{2022 Adjusted} * PFE_6 * RR^6 = 9,466,000 * 0.23 * 0.95^6 = 1,600,427$ kWh

Continue this approach for future years as appropriate.

Apply the same approach to calculate cost-effectiveness inputs for kW and for Therms, using appropriate factors and lifetimes.

WATER IMPACT DESCRIPTIONS AND CALCULATION

N/A

DEEMED O&M COST ADJUSTMENT CALCULATION

N/A

REFERENCE TABLES

Persistence studies done to date for HERs-type programs capture effects through a specific time frame and only for the specific program characteristics of the programs studied. While any individual study may not accurately represent conditions in Illinois or those for all Illinois programs, the Illinois TAC has determined that an average of the implied annual decay rates across the electric- or gas-specific studies done to date (Tables 1 and 2 below) is the best currently available data to approximate persistence for the general class of residential HERs-type programs. This protocol assumes a standard decay function with a constant annual savings decay rate, where Persistence in year $t = (1 - \text{Annual Decay Rate})^t$.

It is recommended that the persistence values and the length of persistence application as used in this protocol continue to be reviewed for update once every plan cycle as further longer term and Illinois-specific evaluations are undertaken.

Source	Utility/Location	Number of Months in Program Before Terminated	Number of Post-Treatment Savings Analysis Months	Persistence:								Implied Annual Decay Rate	
				1 Year after Treatment	2 Years after Treatment	3 Years after Treatment	4 Years after Treatment	5 Years after Treatment	6 Years after Treatment	7 Years after Treatment	8 Years after Treatment		
1 & 2	Upper Midwest	24-45	26		62%								21%
1 & 2	West Coast	24	29		67%								18%
1 & 2	West Coast	25-28	34		72%								15%
1 & 3	SMUD	27	12	68%									32%
4	MASS	26	15	67%									33%
5	Duke Energy Progress	22	12	54%									46%
6 & 7	Southern California Edison	12	24	97%	75%								13%
7 & 8	Pennsylvania (PPL & Duquesne)	10-38	16-21		69%								17%
7 & 9	Connecticut	8-14	48	71%	61%	26%	27%						28%
10	Pacific Gas and Electric	30	36	100%	92%	72%							10%
11	Indiana Michigan Power Company	21	27		66%								19%
12	Pennsylvania (Met-Ed &)	20-48	24		41%								36%

Source	Utility/Location	Number of Months in Program Before Terminated	Number of Post-Treatment Savings Analysis Months	Persistence:								Implied Annual Decay Rate
				1 Year after Treatment	2 Years after Treatment	3 Years after Treatment	4 Years after Treatment	5 Years after Treatment	6 Years after Treatment	7 Years after Treatment	8 Years after Treatment	
	Penelec)											
13-20	Puget Sound Energy	24	96	59%	61%	51%	38%	34%	23%	29%	18%	19%
21	ComEd	16-52	60	90%	69%	65%	70%	63%				9%
22	Ameren Illinois	4-90	24	93%	73%							14%
Average Annual Electric Savings Decay Rate:											22%	

Source	Utility/Location	Number of Months in Program Before Terminated	Number of Post-Treatment Savings Analysis Months	Persistence:								Implied Annual Decay Rate
				1 Year after Treatment	2 Years after Treatment	3 Years after Treatment	4 Years after Treatment	5 Years after Treatment	6 Years after Treatment	7 Years after Treatment	8 Years after Treatment	
4	MASS	15	15	36%								64%
10	Pacific Gas and Electric	30	36	60%	44%	37%						28%
13-20	Puget Sound Energy	24	96	94%	69%	80%	83%	72%	63%	63%	62%	6%
22	Ameren Illinois	4-90	24	97%	86%							7%
23	Nicor	12	12	54%								46%
Average Annual Gas Savings Decay Rate:											30%	

Sources:

- http://www.cadmusgroup.com/wp-content/uploads/2014/11/Cadmus_Home_Energy_Reports_Winter2014.pdf
- <https://www.povertyactionlab.org/sites/default/files/publications/899%20Allcott%20and%20Rogers%20AER2014%20The%20Short-Run%20and%20Long-Run%20Effects%20of%20Behavioral%20Interventions.pdf>
- <https://library.cee1.org/content/impact-persistence-evaluation-report-sacramento-municipal-utility-district-home-energy-repor>
- <http://ma-eeac.org/wordpress/wp-content/uploads/2014/11/MA-EEAC-Home-Energy-Report-Savings-Decay-Analysis-Final-Report1.pdf>
- <https://dms.psc.sc.gov/attachments/matter/9F872380-155D-141F-231F53E80756D3C3>

- 6: http://www.calmac.org/publications/DNVGL_SCE_HER_2015_final_to_calmac.pdf
- 7: <http://www.ripuc.org/eventsactions/docket/2.%20RI%20HER%20Savings%20Decay%20Lit%20Review%20FINAL.pdf>
- 8: https://aceee.org/files/proceedings/2016/data/papers/2_935.pdf
- 9: https://www.energizect.com/sites/default/files/R1606_Eversource%20Behavior%20Persistence%20Evaluation_Review%20Draft_4.10.17.pdf
- 10: http://www.calmac.org/publications/PG&E_2016_HER_Energy_and_Demand_Savings_Early_EM&V.pdf
- 11: <https://www.indianamichiganpower.com/global/utilities/lib/docs/info/projects/IMDemandSideManagement/44841%20Jon%20C.%20Walter%20Direct%20Testimony%20%20Attachments%20Vol%20II.pdf>
- 12: http://www.puc.state.pa.us/Electric/pdf/Act129/SWE_Res_Behavioral_Program-Persistence_Study_Addendum2018.pdf
- 13: https://conduitnw.org/_layouts/Conduit/FileHandler.ashx?RID=849
- 14: <http://www.oracle.com/us/industries/utilities/puget-sound-energy-home-3631948.pdf>
- 15: <http://www.oracle.com/us/industries/utilities/herp-puget-sound-energy-3628986.pdf>
- 16: https://conduitnw.org/_layouts/Conduit/FileHandler.ashx?rid=2963
- 17: <http://www.oracle.com/us/industries/utilities/home-energy-reports-err-2015-3697558.pdf>
- 18: <https://conduitnw.org/pages/file.aspx?rid=4252>
- 19: <https://conduitnw.org/Pages/File.aspx?rid=4415>
- 20: <https://conduitnw.org/pages/file.aspx?rid=4976>
- 21: DRAFT <https://s3.amazonaws.com/ilsag/ComEd-HER-Year-Five-Persistence-and-Decay-Study-2019-10-25.docx>
- 22: https://s3.amazonaws.com/ilsag/AIC_2018_Behavioral_Modification_Persistence_Study_Memo_FINAL_2019-10-21.pdf
- 23: http://ilsagfiles.org/SAG_files/Technical_Reference_Manual/Version_6/Evaluation_Documents/Nicor_Gas_HER_Persistence_Study_Part_2_Final_2016-09-21.pdf

MEASURE CODE: CC-BEH-BEHP-V06-250101

REVIEW DEADLINE: 1/1/2027

6.2 System Wide

6.2.1 Voltage Optimization

DESCRIPTION

Voltage optimization (VO)²⁸ is a smart grid technology that flattens voltage profiles and lowers average voltage levels on an electric power distribution grid. Lowering voltage reduces the instantaneous power consumed by customers on VO-enabled feeders,²⁹ which in turn results in energy and demand savings. Voltage optimization is achieved through the operation of distributed sensors, two-way communications infrastructure, remote controls on substation transformer load-tap changers, voltage regulators and line capacitor banks, and integrating/optimizing software.

Unlike energy efficiency programs that achieve savings by providing financial incentives to encourage customers to adopt energy-efficient equipment or behavioral suggestions to encourage them to adopt no-cost energy-saving behaviors, VO involves no direct customer engagement. Instead, savings are achieved by operating the voltage and reactive power controls on VO-enabled feeders in a manner designed to maintain the voltages delivered to affected customers in the lower part of the allowable voltage range.³⁰

In general, reducing the voltage on a feeder reduces power consumed by the connected loads, assuming all other factors of the feeder remain constant. This is a realistic assumption for many types of consumer devices. However, there are several scenarios in which decreasing voltage does not directly result in energy and demand savings. For example, some devices (e.g., electronics) have self-contained control systems that maintain constant power consumption despite the delivered voltage. Other devices increase their power draw when presented with reduced voltage due to nonlinear inefficiencies. Still other devices (e.g., resistive heating) might decrease instantaneous power draw but operate for longer periods; thus their total energy consumption remains approximately constant (similar to the time-shifting effects of demand response programs). This means VO is more effective in reducing load for some device types than others. This may lead it to be more or less effective for specific feeders depending on the exact mix of device types the feeder has.

This measure was developed to be applicable to the following program types: Voltage Optimization. This measure is unique and does not apply to other program types.

DEFINITION OF EFFICIENT EQUIPMENT

To qualify for this measure, feeders must be enabled with VO technology and have VO fully commissioned and operational.³¹

DEFINITION OF BASELINE EQUIPMENT

The baseline assumption is a feeder without any VO technology.

²⁸ Voltage optimization is also referred to a volt-var optimization (VVO) or conservation voltage reduction (CVR).

²⁹ For the purposes of this measure, the term feeder is synonymous with circuit.

³⁰ The bulk of the energy savings that occurs is thus expected to occur on the customer side of the meter, although additional savings is expected from reduced current flows along the full length of the affected feeders.

³¹ Note that any VO On/Off testing for the purposes of evaluation or updating the TRM will not be counted against the utility in claiming savings. VO On/Off testing is an experimental design that involves enabling and disabling the VO system under a predefined schedule for the purposes of testing its functionality. By following a predefined schedule, the VO On/Off design enables modeling of the impact of VO while controlling for factors that may vary over time, such as weather or weekday vs. weekend loads.

DEEMED LIFETIME OF EFFICIENT EQUIPMENT

VO Energy Savings can be renewed every 15 years and have a maximum measure life of 50 years^{32 33}. The renewal would claim the same savings as the original measure for an additional 15 years (up to a maximum of 50 years) after verifying that VO is still operational on the feeder in a manner consistent with the operation that led to the original TRM savings estimate. This does not preclude future consideration of (and TRM development for) a potential new measure that provides greater savings than the VO measure characterized here.

Within the EE Plan submittal ComEd and Ameren shall prepare a planned activation summary of all feeders whose energy savings are set to expire within the timeframe the EE Plan is active. This planned activation summary will indicate the planned activation status of VO feeders in an ‘enabled’ or ‘disabled’ format along with the total energy savings in MWh of each activation status. This check-in will be performed at the same cadence the EE plan is submitted. Once confirmed, the energy savings shall be credited for 15 years until the next renewal period and for a maximum of 50 years. However, if the utility ever ceases to operate VO in such a manner on any circuits, it will report such changes to evaluators and stop claiming persisting savings on such circuits in the year following the year in which operations ceased (even if less than the TRM measure life).

DEEMED MEASURE COST

The costs vary by feeder. Actual costs should be used.

LOADSHAPE

Loadshape C67 – Voltage Optimization – Ameren

Loadshape C68 – Voltage Optimization – ComEd

COINCIDENCE FACTOR

N/A

Algorithm

CALCULATION OF ENERGY SAVINGS

ELECTRIC ENERGY SAVINGS

Annualized savings should be calculated separately for each VO-enabled feeder. The savings reductions during VO On/Off testing shall not be a basis to reduce the estimated savings.³⁴ The off periods from testing shall be treated as if they were on during the evaluation period.

$$\Delta kWh = kWh_{BASE} * \Delta V * CVR_f$$

Where:

³² For ComEd, the first renewal can start in CY2033 with the renewal of CY2018 feeders. For Ameren, the first renewal can start in CY2034 with the renewal of CY2019 feeders

³³ Climate and Equitable Jobs Act (CEJA), Public Act 102-0662, “(b-20) Each electric utility subject to this Section may include cost-effective voltage optimization measures in its plans submitted under subsections (f) and (g) of this Section, and the costs incurred by a utility to implement the measures under a Commission-approved plan shall be recovered under the provisions of Article IX or Section 16-108.5 of this Act. For purposes of this Section, the measure life of voltage optimization measures shall be 15 years. The measure life period is independent of the depreciation rate of the voltage optimization assets deployed. Utilities may claim savings from voltage optimization on circuits for more than 15 years if they can demonstrate that they have made additional investments necessary to enable voltage optimization savings to continue beyond 15 years. Such demonstrations must be subject to the review of independent evaluation.”

³⁴ VO On/Off testing is an experimental design that involves enabling and disabling the VO system under a predefined schedule for the purposes of testing its functionality. By following a predefined schedule, the VO On/Off design enables modeling of the impact of VO while controlling for factors that may vary over time, such as weather or weekday vs. weekend loads.

kWh_{BASE} = Baseline kWh consumption on the feeder per year³⁵

For Ameren territory, use the average annual customer energy use for each feeder over the 2014-2016 timeframe, less energy use by exempt customers.

For ComEd territory, use annual energy consumption using the actual energy measurement during the time when VO was off (as appropriate; this may include the actual measurements prior to VO activation during the given program year and from prior program years and VO OFF periods from subsequent program years) and a calculated VO OFF value for the time when VO was on. The VO OFF baseline energy for the periods when VO is on shall be calculated using:

$$E_{VO_OFF} = \frac{E_{VO_ON}}{1 - (CVR_f * \Delta V)}$$

Where:

E_{VO_OFF} = the calculated VO OFF energy consumption when VO is on (activated)

E_{VO_ON} = the actual measured energy consumption during the period when VO is on

ΔV = the voltage reduction

CVR_f = the CVR factor

- i. Where power (MW) data has not been established yet, best available data from the feeder line measurement devices should be considered.
- ii. Data are clustered into bins according to temperature range,³⁶ season,³⁷ day type (weekday/weekend),³⁸ and hour of the day based on the VO OFF and ON statuses to create a lookup table. If multiple data points are found (i.e., same temperature range, same season, same day type, same hour of the day, and same VO status), the average of multiple references are placed into the lookup table. Various combinations of these variables may be used in an order of decreasing priority when no data points are found that match all of them.
- iii. The independent evaluator shall use best practices, including an appropriate technique that is transparent, replicable, and most accurate, to address any data quality issues, with input from interested stakeholders, including ComEd.
- iv. The following approach will be used for claiming kWh savings from no-load and future feeders. ComEd installs new feeders every year to accommodate area load growth. Some of them are sourced from previously claimed VO-activated substations or exist with no-load on transformers where VO is being activated in a given year. Examples of when a new feeder will be installed include, as part of a new business project to

³⁵ If the energy consumption baseline is measured at the feeder head, an adjustment will be made to recognize line losses and loss savings.

³⁶ Temperature bins are to the ceiling of the nearest 5°F interval.

³⁷ Seasons are defined as follows; Spring: March through May; Summer: June through August; Fall: September through November; and Winter: December through February.

³⁸ Weekdays are Monday to Friday and weekends are Saturday and Sunday.

accommodate a new or existing customer’s load addition, or to relieve area loading congestion and contingency planning for the purpose of increasing capacity. ComEd projects load on some of these feeders over a future period, however, there are uncertainties regarding when the projected target loads will materialize.

ComEd cannot claim VO savings for a newly commissioned feeder while there is no load but can claim when a pre-defined threshold of the feeder’s projected load is reached. A threshold of 70% of projected load for 6 months is adopted for ComEd.³⁹ To be eligible for savings, the feeder must add load to the substation transformer rather than simply splitting existing load among the feeders sourced from same transformer.

ComEd will maintain a list of existing feeders with no-load along with their projected load, to be updated as needed, and will share it with their evaluator so they can make comparisons to the threshold when the feeder is claimed. Changes can be made to the projected load, as needed, with justification. When such feeders reach the threshold of 70% of their projected load for 6 months, ComEd will notify their evaluator and provide relevant feeder and associated substation transformer data to evaluators for the purpose of verifying savings to claim in the annual impact evaluation report.

ΔV = Percentage voltage reduction on the feeder caused by VO

For Ameren territory, voltage reduction shall be calculated using a pre-post regression model (i.e., comparing pre-VO and post-VO installation). The model specification will be selected based on model fit and may vary year to year. The model will be run in accordance with the terms provided in subsections (i) through (iv) below:

- i. The model utilizes pre-period (VO OFF) data from the feeders in question from the prior calendar year.
- ii. Voltage (V) data is sourced from customer AMI meters. The feeder average voltage is calculated as the average of at least 70% of the AMI meters on the feeder, whenever possible.⁴⁰ AMI voltage readings are normalized by their nominal voltage before averaging voltage across the AMI meters on a given feeder.
- iii. Ameren and stakeholders have agreed on a list of excludable events, during which Ameren may claim VO savings if the system is down for reasons deemed appropriate. Please see

³⁹ This threshold was determined based on the discussion between ComEd’s Capacity planning and Voltage Optimization group. To determine the value, ComEd considered several factors including the timeline of commissioning any future feeder, load ramping up for large customers, and the comments received from ICC and Guidehouse to claim the feeders as soon as ComEd expects to have full load. ComEd considers a feeder to have reached its full load when 70% of the projected load (at the minimum) has been materialized.

⁴⁰ In cases when less than 70% of the AMI meters are programmed to record voltage data, all available meters will be used, with the goal of utilizing as close to 70% of the meters as possible.

Table 1 below for further explanation and list of excludable and non-excludable events.

- iv. The independent evaluator shall use best practices, including an appropriate technique that is transparent, replicable, and most accurate, to address any data quality issues, with the input from interested stakeholders, including Ameren.

For ComEd territory, voltage reduction shall be calculated from voltage measurements taken from the feeder’s head end primary voltage source using the following equation and in accordance with the terms provided in subsections (i) through (iv) below:

$$\Delta V = \left(\frac{V_{OFF} - V_{ON}}{V_{OFF}} \right)$$

- v. When VO is off, the voltage if VO was on needs to be estimated and vice versa. Actual measurements shall be used for the off voltage when VO is off and the on voltage when VO is on.
- vi. Data are clustered into bins in accordance to temperature range,⁴¹ season,⁴² day type (weekday/weekend),⁴³ and hour of the day based on the VO OFF and ON statuses to create a lookup table. If multiple data points are found (i.e., same temperature range, same season, same day type, same hour of the day, and same VO status), the average of multiple references are placed into the lookup table. Various combinations of these variables may be used in an order of decreasing priority when no data points are found that match all of them.
- vii. The independent evaluator shall use best practices, including an appropriate technique that is transparent, replicable, and most accurate, to address any data quality issues, with the input from interested stakeholders, including ComEd.
- viii. The counterfactual VO ON and VO OFF profiles shall be created for each feeder for the entire program year using the lookup table for temperature range,⁴⁴ season,⁴⁵ day type (weekday/weekend),⁴⁶ and hour of the day.
- ix. If VO is ON in a continuous basis throughout the year, previous year’s voltage data along with temperature, day type, and time of the day can be correlated in accordance to present year’s temperature data, day type, and time of the day to create the VO OFF profile. This correlation shall use the data created from the most representative feeder or feeders that have undergone testing.

⁴¹ Temperature bins are to the ceiling of the nearest 5°F interval.

⁴² Seasons are defined as follows; Spring: March through May; Summer: June through August; Fall: September through November; and Winter: December through February.

⁴³ Weekdays are Monday to Friday and weekends are Saturday and Sunday.

⁴⁴ Temperature bins are to the ceiling of the nearest 5°F interval.

⁴⁵ Seasons are defined as follows; Spring: March through May; Summer: June through August; Fall: September through November; and Winter: December through February.

⁴⁶ Weekdays are Monday to Friday and weekends are Saturday and Sunday.

- X For the no-load and future feeders, ComEd’s evaluator will use the evaluated historical transformer voltage reduction for each feeder going back to the year when the station or transformer was originally VO-enabled.⁴⁷

CVR_f = conservation voltage reduction factor relating the change in voltage to a change in energy
 = 0.80 (for both Ameren and ComEd territories)⁴⁸

SUMMER COINCIDENT PEAK DEMAND SAVINGS

Peak demand savings should be calculated separately for each VO-enabled feeder. The savings reductions during VO On/Off testing shall not be a basis to reduce the estimated savings. The off periods from testing shall be treated as if they were on during the evaluation period.

$$\Delta kW = kW_{BASE} * \Delta V_{PEAK} * CVR_{f,PEAK}$$

Where:

kW_{BASE} = Baseline kW usage on the feeder during the peak period, defined as 1:00-5:00 pm CDT on non-holiday weekdays from June 1 to August 31.

For Ameren territory, this will be calculated as the average demand in the peak hour for each feeder over the 2014-2016 timeframe, adjusted by a calibration factor that describes the relationship between demand in the peak hour and average demand over the peak period (defined as 1:00-5:00 pm CDT on non-holiday weekdays from June 1 to August 31). This calibration factor will be calculated based on a sample of feeders for which 2014-2016 data is available.

For ComEd territory, this will be calculated in the same manner as kWh_{BASE} for energy savings but with the intent of estimating the baseline just for the peak period as opposed to for the entire year.

ΔV_{Peak} = Percentage voltage reduction on the feeder caused by VO during the peak period, defined as 1:00 – 5:00 pm CDT on non-holiday weekdays from June 1 to August 31.

For Ameren territory, this will be calculated in the same manner as ΔV for energy savings but with the intent of estimating ΔV just for the peak period as opposed to for the entire year.

For ComEd territory, this will be calculated in the same manner as ΔV for energy savings but with the intent of estimating ΔV just for the peak period as opposed to for the entire year.

CVR_{f,PEAK} = conservation voltage reduction factor relating the change in voltage to a change in energy specifically for the peak period, defined as 1:00 – 5:00 pm CDT on non-holiday weekdays from June 1 to August 31

For Ameren territory, 0.68.⁴⁹

For ComEd territory, 1.02.⁵⁰

⁴⁷ This is recommended by ComEd to ensure consistency that all the feeders under the same transformer receive same average voltage reduction using both timeseries VO ON and OFF data from the testing period.

⁴⁸ Guidehouse. 2020. *Supporting Documentation for Voltage Optimization TRM Measure*. <Add hyperlink when available>

⁴⁹ Ibid.

⁵⁰ Ibid.

EXCLUDABLE AND NOT-EXCLUDABLE EVENTS IN CALCULATING ELECTRIC SAVINGS

Both Ameren and ComEd have established a set of excludable (where VO is off, but savings can be claimed as if VO is on) and not-excludable (where VO is off, and savings cannot be claimed) events. These events can be accounted for either by: 1) determining the percentage of time non-excludable events occur and de-rating the savings by this percentage (ComEd’s approach), or 2) removing the excludable events from the dataset used to calculate savings (Ameren’s approach).

Below are tables of events each utility has established as excludable and non-excludable. Changes or additions can be made to these tables with the consensus of the utilities, the independent evaluator, and ICC staff (none of whose consensus shall not be unreasonably withheld).

Table 1. Ameren Excludable and Non-Excludable VO Events

Event	Description	Reason/Explanation	Category
Feeder Outage	Anytime the majority of a feeder is out due to any reason.	Feeder outages are typically not predictable or planned and are outside of Ameren’s control. They are an anomaly and are not certain to occur on the same feeder in subsequent years.	Excludable
Repair / Maintenance	Repair or maintenance work is performed on a VO feeder causing VO to be disabled.	Repair and maintenance of Ameren’s system is an operational necessity to provide customers with safe and reliable electric service. These events are not certain to occur on the same feeder in subsequent years.	Excludable
Switching	Dispatch disables VO on the feeder for any necessary switching event.	Ameren will perform switching for storms, outages, repair, maintenance, safety, and work to support new customer growth. These events are not certain to occur on the same feeder in subsequent years.	Excludable
Technology	A failure of the Information and/or Communication Technology which results in "all" VO feeders being disabled simultaneously due to events outside of Ameren’s control.	VO is dependent upon third party infrastructure that Ameren has no control over. Examples include the loss of the cellular communications network (AT&T and Verizon), the failure of the VO Software provided by the outside vendor, or a Cyber event. Events of this nature are an anomaly and are not certain to occur year after year. This event is not predictable or planned and is outside of Ameren’s control.	Excludable
Worldwide Pandemic / Orders by Civil Authorities	Repairs and maintenance may take longer due to limited crew availability or other restrictions/priorities. Example: COVID-19	Due to restrictions, repairs and maintenance may take longer. This reasonable delay is outside the control of Ameren.	Excludable
Disaster Recovery (DR) Testing	Ameren periodically performs Disaster Recovery testing on systems (AMI, ADMS, VO, etc.) which could result in VO disabling. Typically all VO feeders would be affected during DR testing.	Disaster Recovery is necessary and critical to ensure that Ameren can operate safely and effectively during an unforeseen event.	Not-Excludable

Event	Description	Reason/Explanation	Category
Server patching/issues	Anytime servers go down or patching takes place and the VO system does not come back online due to servers not rebooting correctly.	Events of this nature are unavoidable, but should be addressed by Ameren in a timely fashion. This should result in negligible impacts to energy savings.	Not-Excludable
Configuration Changes	Anytime VO is disabled for making updates to the Orion, go-live testing, or to make changes on the system resulting in shutting down services.	Events of this nature are unavoidable, but should be addressed by Ameren in a timely fashion. This should result in negligible impacts to energy savings.	Not-Excludable
VO field hardware failures	The loss or failure of a voltage regulator control, LTC control, or switched capacitor control on a feeder.	Events of this nature are unavoidable, but should be addressed by Ameren in a timely fashion. This should result in negligible impacts to energy savings.	Not-Excludable
Loss of communications	Anytime a device has a communications failure that would result in VO disabling. This event does not include 3 rd party cellular communications network (AT&T and Verizon) failures.	Events of this nature are unavoidable, but should be addressed by Ameren in a timely fashion. This should result in negligible impacts to energy savings.	Not-Excludable

Table 2. ComEd Excludable and Non-Excludable VO Events

Event	Description	Reason/Explanation	Category
System Operational Requirements	OCC takes control and disables VO due to station/feeder out of configuration, major alarm, repair/maintenance or switching events.	Feeder outages are typically not predictable or planned and are outside of ComEd control. ComEd will take necessary steps to ensure the reliability and safety of the system during storms and outages, maintenance, and work to support new customer growth. These events are not certain to occur on the same feeder in subsequent years.	Excludable
Loss of communication	Any unplanned interruption to the communication network.	Natural causes or unplanned repair due to equipment failure occasionally disrupting communication network.	Excludable
VO Control System	System component failure requires vendor upgrade or revision.	The failure of the VO Software provided by the outside vendor (OSI), or a Cyber event. Events of this nature are an anomaly and are not certain to occur year after year. This event is not predictable or planned and is outside of ComEd’s control.	Excludable
VO On/Off Cycling Schedule	Supervision over the transitional states from on to off, and vice versa.	When adding or commissioning substations or feeders to the VO Control system.	Excludable
Customer Maintenance	VO is disabled to investigate power quality issues.	Possible VO deactivation may be required to facilitate certain investigation requirements.	Not-Excludable
Worldwide Pandemic / Orders by Civil Authorities	Repairs and maintenance may take longer due to limited crew availability or other	Due to restrictions, repairs and maintenance may take longer. This reasonable delay is outside the control of ComEd.	Excludable

Event	Description	Reason/Explanation	Category
	restrictions and priorities. Example: COVID-19		
VO Control System	Anytime VO system fails to operate due to model error in VO software, or inappropriate manual settings (human error).	Events of this nature should be addressed by ComEd in a timely manner, resulting in negligible impacts to energy savings.	Not-Excludable
Loss of communication	Any planned system upgrade that interrupts communication.	Planned system patching or upgrades interfere with the communication network and disable VO. This should be addressed by ComEd in a timely manner, resulting in negligible impacts to energy savings.	Not-Excludable
Equipment	Equipment failure that results in VO feeders being disabled (MJ5/DCIAB).	The equipment failure should be addressed by ComEd in a timely manner. This should result in negligible impacts to energy savings.	Not-Excludable
Server patching/ issues	Anytime servers would go down or if patching took place and VO system did not come back online due to servers not rebooting correctly.	Events of this nature are unavoidable but should be addressed by ComEd in a timely manner. This should result in negligible impacts to energy savings.	Not-Excludable

FOSSIL FUEL SAVINGS

N/A

WATER AND OTHER NON-ENERGY IMPACT DESCRIPTIONS AND CALCULATION

VO may provide non-monetized energy benefits in the form of improved ability to manage the grid “downstream” of the substation. This could result in improved reliability, lower spending on other grid improvements, or both. Further research is needed to understand the scope and impact of these potential benefits. There are no water savings or non-energy impacts from VO.

DEEMED O&M COST ADJUSTMENT CALCULATION

There are annual O&M costs incurred by the utility as a result of implementation of VO. Cost-effectiveness analysis should include estimates of annual O&M costs over the initial 15-year period and then for each incremental renewal period up to 50 years of the VO investment, discounted to present value for the year in which the VO investment is being analyzed. O&M cost estimates should include (a) labor and equipment costs to maintain the system and (b) third-party software costs.

MEASURE CODE: CC-SYS-VOPT-V03-230101

REVIEW DEADLINE: 1/1/2028

Consistent with the definition of Review Deadline in TRM Volume 1 (Overview), the Voltage Optimization working

group collectively acknowledges that this date does not represent a commitment or obligation to revise TRM content by this date.

6.3 Purchasing Tools

6.3.1 Efficient Choice Tool

DESCRIPTION

Efficient Choice (EC) is an online platform that facilitates energy efficient retail purchases. Users⁵¹ can compare products in a wide range of electric and gas residential product categories, including but not limited to home appliances, consumer electronics and heating and cooling equipment. Users may choose from among current retail offers and are redirected to retailer websites to purchase. EC is designed to eliminate market, cognitive, and psychological barriers to the adoption of energy efficient products through comparisons that include product specifications, pricing, information on energy consumption, and a number of other pieces of information.

Because EC does not track “participants,” estimation of savings is reliant on a combination of observed website traffic and surveys of utility customers who may have engaged with the website.⁵² Program tracking data and survey responses are used to identify utility customers who engaged with EC, estimate those customers’ purchase rates for product categories found on the site, and the proportions of those purchases that were energy-efficient and did not receive an incentive through another energy efficiency program. Whenever available, program tracking data should be used before self-reported survey results. Surveys include a verification component to validate energy-efficient purchases reported by survey respondents.

Observed website traffic is then used to estimate the number of unique customers who have engaged with the website, referred to as “unique active shoppers” (for further detail, please see the Unique Active Shoppers section of this measure). Unique active shopper counts are then used to scale estimated energy-efficient purchase quantities to the population of unique active shoppers to estimate the total number of energy-efficient products purchased by unique active shoppers. Per-unit savings are then estimated using the most appropriate measure-specific IL-TRM specifications.

DEFINITION OF EFFICIENT EQUIPMENT

The specific definitions of the efficient case vary by type of equipment purchased. For many common product categories (for example, clothes washers), definitions of the efficient case are provided in Volume 3 of the IL-TRM, and should be used. For categories of equipment not yet characterized in the IL-TRM, provisional efficient case definitions can be used at evaluation discretion.

DEFINITION OF BASELINE EQUIPMENT

The specific definitions of the baseline case vary by type of equipment purchased. For many common product categories (for example, clothes washers), definitions of the baseline case are provided in Volume 3 of the IL-TRM, and should be used. For categories of equipment not yet characterized in the IL-TRM, provisional baseline case definitions can be used at evaluation discretion.

DEEMED LIFETIME OF EFFICIENT EQUIPMENT

Measure lives should be sourced from the product category’s corresponding measure in Volume 3 of the IL-TRM. For categories of equipment not yet characterized in the IL-TRM, provisional measure lives can be used at evaluation discretion.

DEEMED MEASURE COST

Incremental costs should be sourced from the product category’s corresponding measure in Volume 3 of the IL-TRM by default. At evaluation discretion, deviations from IL-TRM specified incremental costs can be made with sufficient

⁵¹ As currently implemented, EC is typically a publicly-facing website and can be used by anyone.

⁵² Discussion of the identification of the population of utility customers who may have engaged with EC and therefore should be included in evaluation research is outside of the scope of the IL-TRM.

justification.

LOADSHAPE

N/A

COINCIDENCE FACTOR

Per-unit demand savings for each product category should apply coincidence factors from corresponding measure in Volume 3 of the IL-TRM.

PURCHASE RATES

Survey research should inform purchase rates for each product category and each utility’s EC. These rates, broadly, reflect the portion of customers who engaged with each product category and went on to purchase non-rebated energy-efficient products. Purchase rates should not count rebated or non-energy efficient products as EC purchased measures. Purchase rates should be calculated as the product of the four survey-based response ratios from EC participants that actively engaged with the EC site. These include:

- 1) The portion of EC users who reported purchasing a product of any efficiency level after engaging with the respective product category on the EC website
- 2) The portion of customers who purchased a product of any efficiency level who reported purchasing a product that did not receive any form of utility rebate;
- 3) The portion of customers who purchased a non-rebated product who reported purchasing an efficient product; and
- 4) The portion of customers who reported an efficient purchase who were able to verify the efficiency of this product by providing the manufacturer model number or SKU.

The equation below describes the calculation of product level a purchase rate formulaically.

$$\text{Purchase Rate} = \frac{\text{Number of self reported purchases}}{\text{Total number of self reported EC users who engaged with the respective product category}} \times \frac{\text{Number of purchases without a utility rebate}}{\text{Number of self reported purchases}} \times \frac{\text{Number of self reported efficient purchases}}{\text{Number of purchases without a utility rebate}} \times \frac{\text{Number of verified efficient purchases}}{\text{Number of self reported efficient purchases with verifiable efficiency ratings}}$$

Purchase rates should be determined through evaluation. The targeted confidence and precision for purchase rates should also be determined by the evaluator.

In some cases, like measures may be grouped together if there is not enough EC activity for individual evaluation. For example, televisions and monitors can be grouped under an overall electronics purchase rate. The grouping of measures under a single purchase rate should be determined by the evaluator.

Purchase rates may be deemed for future use after research of specific product categories. Deemed purchase rates should be reevaluated as determined by evaluators and/or the TAC.

PURCHASE QUANTITY

For some measures presented on EC, customers can purchase multiple units. Purchase quantities should be determined through evaluation.

For measures purchased with utility rebates, their associated energy, demand, water and natural gas savings should be claimed by the program incentivizing the measure. Savings from measures receiving rebates should not be claimed by EC as detailed in the purchase rate section above.

UNIQUE ACTIVE SHOPPER COUNT

The count of unique active shoppers is based on observed web traffic associated with each product category and should reflect the total number of EC visitors that actively engaged with the product. Active engagement is defined as an EC visitor who conducted at least one of ten specific actions on the site.⁵³ These values should be provided by implementer staff for the duration of the participation period and verified through evaluation.

Algorithm

CALCULATION OF ENERGY SAVINGS

ELECTRIC ENERGY SAVINGS

$$\Delta kWh = PR \times Qty \times UAS \times kWh_{per}$$

PR = Purchase rate (defined above).

Qty = Average purchase quantity

UAS = Count of Unique Active Shoppers for each product category

kWh_{per} = Develop unitary electric energy savings based on the measure’s corresponding TRM section
 kWh_{per} should include secondary kWh savings where appropriate.

Summer Coincident Peak Demand Savings

$$\Delta kW = PR \times Qty \times UAS \times kW_{per}$$

kW_{per} = Develop unitary demand savings based on the measure’s corresponding TRM section.

FOSSIL FUEL SAVINGS

$$\Delta Therms = PR \times Qty \times UAS \times Therms_{per}$$

Therms_{per} = Develop unitary therm savings based on the measure’s corresponding TRM section.

WATER AND OTHER NON-ENERGY IMPACT DESCRIPTIONS AND CALCULATION

$$\Delta Water (gallons) = PR \times Qty \times UAS \times \Delta Water_{per}$$

Where

ΔWater (gallons) = Water saved, in gallons

ΔWater_{per} = Develop unitary water savings based on the measure’s corresponding TRM section.

DEEMED O&M COST ADJUSTMENT CALCULATION

N/A

MEASURE CODE: CC-PTS-ECT-V01-230101

REVIEW DEADLINE: 1/1/2025

⁵³ Actions include: (1) recommendations engaged, (2) product selected, (3) product list sorted, (4) product list filtered, (5) histogram engaged, (6) product favorites engaged, (7) search saved, (8) offer clicked, (9) compare button engaged, (10) compare started.

2024 Illinois Statewide Technical Reference Manual for Energy Efficiency Version 12.0

Attachment A

Illinois Statewide Net-to-Gross Methodologies

Effective for Evaluation

All NTG data collection and analysis activities for the program types covered by this document shall conform to the NTG methods set forth herein.

Attachment A: Illinois Statewide Net-to-Gross Methodologies

1 Policy Context for this Information

Starting in 2014, the Illinois Evaluation Teams (Cadmus Group, Itron, Navigant Consulting, Opinion Dynamics, Ridge & Associates) worked with the Illinois Stakeholder Advisory Group (SAG) to create an Illinois Statewide Net-to-Gross (NTG) Methodologies document (IL-NTG Methods). This document has been updated annually, including with input from the current Illinois Evaluation Teams (Guidehouse, Opinion Dynamics, Ridge & Associates, and Verdant). The IL-NTG Methods document is included as an attachment to the Illinois Statewide Technical Reference Manual for Energy Efficiency (IL-TRM). Through five different dockets, the Illinois Commerce Commission (ICC) has directed the Evaluation Teams to compile and formalize standard NTG methods for use in Illinois energy efficiency (EE) evaluation, measurement, and verification (EM&V) work. The ICC EE dockets are shown in the following table.

Table 1-1. ICC Energy Efficiency Dockets

ICC Order Docket No. and Date	Program Administrator	NTG Discussion – Order Pages	ICC Link
13-0495 (1/28/14)	Commonwealth Edison Company (ComEd)	129-130	http://www.icc.illinois.gov/downloads/public/edocket/367591.pdf
13-0498 (1/28/14)	Ameren Illinois Company (Ameren)	167, 171	http://www.icc.illinois.gov/downloads/public/edocket/367603.pdf
13-0499 (1/28/14)	Illinois Department of Commerce & Economic Opportunity (Department of Commerce)	20, 23, 49	http://www.icc.illinois.gov/downloads/public/edocket/367581.pdf
13-0549 (5/20/14)	Nicor Gas Company (Nicor)	41-42, 78	http://www.icc.illinois.gov/downloads/public/edocket/378494.pdf
13-0550 (5/20/14)	North Shore Gas Company (North Shore Gas) and The Peoples Gas Light and Coke Company (Peoples Gas) (collectively, PG&NSG)	54-55, 66	http://www.icc.illinois.gov/downloads/public/edocket/378495.pdf

To provide clarity to the ICC directives, the relevant section on IL-NTG Methods is shown in its entirety from the Nicor Gas Order (Docket No. 13-0549). The Nicor Gas Order provides the most detail on the ICC NTG directive in comparison to the other EE orders. The Nicor language is as follows:

The Commission believes that Staff’s recommendations concerning Commission adoption of consistent statewide net-to-gross methodologies (“IL-NTG Methods”) for use by the evaluators are reasonable and will aid in future evaluation of the energy efficiency programs. To help ensure the independence of the evaluators, to improve efficiency in the evaluation process, and to ensure programs across the state as delivered by the various Program Administrators can be meaningfully and consistently evaluated, the Commission hereby adopts Staff’s recommendation that consistent IL-NTG Methods be established for use in the evaluations of comparable energy efficiency programs offered by different Illinois Program Administrators. The Commission notes that Section 8-104(k) of the Act encourages statewide coordination and consistency between the gas and electric energy efficiency programs and Staff’s proposal would help ensure consistency in the evaluation of program performance. The Commission notes that this directive is not to create entirely “new” NTG methodologies for every energy efficiency program, but rather to assess NTG methodologies and survey instruments that have been used to evaluate energy efficiency programs offered in Illinois, and to compile the most justifiable and well-vetted methodologies (or potentially combine certain components from the existing approaches to better represent the most justifiable and well-vetted method consistent with best practices) in an attachment to the Updated IL-TRM that would

get submitted to the Commission for approval. The Commission notes that the IL-NTG Methods will be flexible and adaptable to multiple program designs and budgets and tailored to appropriately assess the specifics of each of the Program Administrators' energy efficiency programs, consistent with standard NTG methodologies adopted in other states that were filed in this proceeding. The Commission agrees with Staff that in the interest of efficiency, the current program evaluators should take the lead in compiling and formalizing standard methodologies for NTG in Illinois taking into consideration SAG input. Because the existing Plan 1 evaluators are under contract with the Company for the evaluation of the program year three energy efficiency programs, it is appropriate for these existing evaluators to work on and complete the compilation of the IL-NTG Methods over the next year. The Commission recognizes that each year considerable time may be spent vetting NTG methodologies for each program evaluation separately for each utility under the existing evaluation plan review practices; adoption of IL-NTG Methods would save on these limited evaluation resources by having a common reference document for the evaluators to use in estimating net savings for Illinois.

The Commission hereby directs the Company to require its evaluators to collaborate with the other Illinois evaluators and the SAG to use best efforts to reach consensus on the approaches used in assessing NTG in particular markets for both residential and non-residential energy efficiency programs in a manner consistent with the direction described herein. (Pages 41-42)

- (16) Northern Illinois Gas Company shall require its evaluators to collaborate with the other Illinois evaluators and the SAG to reach consensus on the most defensible and well-vetted methodologies for assessing net-to-gross ratios in particular markets for both residential and non-residential energy efficiency programs in a manner consistent with the direction provided herein.
- (17) ICC Staff shall file the agreed-upon consensus statewide NTG methodologies with the Commission as an attachment to the Updated IL-TRM, and if consensus is not reached on a certain component of the statewide NTG methodologies, that particular non-consensus component should be submitted in a manner consistent with the approach used for non-consensus IL-TRM Updates. (Page 78)

1.2 Programs Currently Covered in this Document

This document is intended to cover the majority of residential and non-residential programs offered in Illinois.⁵⁴ Programs covered as of the writing of this document are listed in tables at the beginning of Section 3:

Commercial, Industrial, and Public Sector Protocols and Section 4: **Residential and Low Income Sector Protocols**. If the design of a given program changes significantly, then it may mean that the NTG protocol listed for that program in this document is no longer appropriate. If that happens, the evaluator should follow the procedures outlined below under Section 1.4: Diverging from the IL-NTG Methods.

This document will be updated over time to incorporate new programs and to reflect recommended changes to existing methodologies. All NTG data collection and analysis activities for the program types covered by this document shall conform to the NTG methods set forth herein.

1.3 Updating the IL-NTG Methods

This attachment is part of the IL-TRM and follows the timeline for updating of the IL-TRM, as specified in the Illinois Energy Efficiency Policy Manual. In general, the following will take place:

- Updates will generally occur annually.
- Any changes to the IL-NTG Methods document will be circulated to the full SAG, and SAG participants will have a ten business day review process.
- Updates may be discussed within the SAG throughout the year but will be completed annually.

⁵⁴ Evaluation reports on those programs can be found at <http://www.ilsag.info/evaluation-documents.html>.

- Annually, the ICC Staff will submit a Staff Report (with the consensus Updated IL-TRM attached) to the Commission with a request for expedited review and approval.
- Updated NTG methods go into effect upon SAG approval, which may be before the annual TRM update or before the effective date of the updated TRM.

1.4 Diverging from the IL-NTG Methods

The NTG methods for the programs outlined in this document are partially binding. The criteria for deviating from the IL-NTG Methods document are set forth below. In all cases, the evaluators (or any interested stakeholder) submits the proposed deviation to the full SAG for a ten business day SAG review and comment period. In the event of an objection by a SAG participant, efforts may be made to see if consensus can be reached on the proposed deviation in a subsequent monthly SAG meeting. In this case, a final opportunity for SAG review and comment to the proposed deviation will be provided following the SAG meeting.

Evaluators may modify the approaches described in this document if the following three conditions have been satisfied:

1. Evaluators must explicate within the annual evaluation research plan (or another document) how specific items in the proposed modified NTG method will diverge from what is written in this document. Evaluators must justify why the divergence is appropriate.
2. Prior to the use of the modified NTG method for a particular program, evaluation teams must be in agreement on the use and execution of the modified NTG method.
3. Any objection from SAG participants regarding the proposed modified NTG method is resolved.

Evaluators may test alternative methods of estimating NTG for a particular program in addition to the NTG methods outlined in this document, if the following three conditions have been satisfied:

1. Evaluators must explicate within the annual evaluation research plan (or other document) the proposed alternative NTG method. Evaluators must explain why the proposed alternative NTG method might be superior to the NTG methods outlined in this document for the particular program. Evaluators must discuss the foundation for expecting that the proposed alternative NTG method is likely to produce meaningful results.
2. Prior to the use of the alternative NTG method for a particular program, evaluation teams must be in agreement on the key details of the approach for implementing the alternative NTG method.
3. Any objection from SAG participants regarding the proposed alternative NTG method gets resolved.

When performing alternative NTG methods for a particular program, the choice of methods may vary across the state. For example, if ComEd's evaluator chooses to test Methods 1 and 2 for a particular program, Ameren's evaluators do not also have to perform Methods 1 and 2 for a similar program.

Several sections of this attachment provide example questions that can be used to collect the data required in the NTG algorithms. Adjustments to refine specific question wording, e.g., to better reflect the design of the evaluated program, do not constitute divergence from the IL-NTG Methods. Evaluators are not required to use the exact wording provided in the example questions.

1.5 Procedure for Non-Consensus Items

Non-consensus items that arise during the development and updating of the IL-NTG Methods document will be handled in substantially the same way as non-consensus IL-TRM Updates are addressed. The approach to be used is

as follows.

- Once the Illinois NTG Working Group⁵⁵ has progressed as far as they can on the methodology, and it has been found that there is non-consensus on a specific Net-to-Gross Methods topic or procedure, the Illinois NTG Working Group shall submit to the ICC Staff and the SAG’s Technical Advisory Committee (TAC) a “Comparison Exhibit of Non-Consensus Net-to-Gross Methods topics/procedures” within two weeks after the Illinois NTG Working Group has failed to reach consensus. The TAC will then deliberate on the issue with a goal of reaching consensus.
- If consensus does not emerge in the TAC regarding a particular Net-to-Gross Methods topic or procedure, the “Comparison Exhibit of Non-Consensus NTG Methods topics/procedures” is then sent to the full SAG for their deliberations and input. The SAG provides a forum where experts on all sides of the contested issue can present their expert opinions in an effort to inform parties of the contested issue and to also facilitate consensus.
- To the extent a consensus among Program Administrators and non-financially interested stakeholders cannot be reached regarding issues related to specific Net-to-Gross Methods topic or procedure updates, the IL-TRM Administrator shall have the authority to use its best judgment to propose a resolution of the issue and include such in the updated IL-TRM that gets submitted to the ICC for approval. For transparency and informational purposes, the ICC Staff will document such dispute and include a link to a “Comparison Exhibit of Non-Consensus Net-to-Gross Methods topics/procedures” developed by the Illinois NTG Working Group and the IL-TRM Administrator in the Staff Report submitted to the Commission. The “Comparison Exhibit of Non-Consensus Net-to-Gross Methods topics/procedures” will document, with input from the parties, the various parties’ positions concerning a non-consensus Net-to-Gross Methods topic or procedure update as well as the IL-TRM Administrator’s rationale for its decision to resolve the issue.
- Nothing in this language shall preclude Program Administrators and stakeholders from challenging the IL-TRM Administrator’s proposed resolution by petitioning the Commission. Until the Commission resolves the petition, the Commission-approved Net-to-Gross Methods topic or procedure shall be the default pending the issuance of a Commission Order. The applicable date for the Commission-resolved Net-to-Gross Methods topic or procedure will be the latter of January 1 of the year the IL-TRM was designed to go into effect, or the first day of the next month following the Commission order. In the petition, the filing party should note all Program Administrators affected by the IL-TRM dispute, and request that the Commission join each affected Program Administrator to the docket.

⁵⁵ The Illinois NTG Working Group consists primarily of the subset of Evaluators deliberating on NTG methodologies; however, any interested party may participate in the Illinois NTG Working Group.

2 Attribution in Energy Efficiency Programs in General

One of the most difficult aspects of evaluation, and not just within evaluation of energy efficiency programs, is attributing results to a program. Attribution provides credible evidence that there is a causal link between the program activities and the outcomes achieved by the program. Attribution research estimates the difference between the outcomes and those that would have occurred absent the program (i.e., the counterfactual). Put in research terms, evaluators must reject the null hypothesis of no causality through probabilistic statements (e.g., “strong evidence”; “high probability”). As such, it is important to realize that the concept of the counterfactual cannot be proven with certainty. So even though the NTG ratio is a single value, conceptually it is a probabilistic statement.⁵⁶ One of the main academics within evaluation stated that there is a “...total and inevitable absence of certain knowledge [arising] from the methods social scientists use” when assessing the counterfactual. (Shadish, et al., 2002) This statement is not about poor methods, but about the counterfactual itself. Because programs work with people and are usually not a laboratory experiment that can be replicated over and over⁵⁷ to find out what actions people would have taken absent an intervention, one would need a time machine to take people back in time and not provide the program. Since time machines do not exist, evaluators have developed methods that approximate the counterfactual to the best of their ability.

2.1 Definitions

For energy efficiency programs, evaluators differentiate between savings at a “gross” and “net” level as described below in the short set of relevant definitions. These definitions are not all encompassing or meant to restrict evaluation in any way, but to provide context before additional detail is provided in later sections. Research to determine attribution occurs to allow for a better understanding of the net level of savings.

Table 2-1. Definitions

Concept	Term	Definition
Consumers	Nonparticipant	Any consumer who was eligible but did not participate in the subject efficiency program, in a given program year.
	Participant	A consumer who received a service offered through the subject efficiency program, in a given program year; also called program participant. The term “service” is used in this definition to suggest that the service can be a wide variety of inducements, including financial rebates, technical assistance, product installations, training, energy efficiency information, or other services, items, or conditions. Each evaluation plan should define “participant” as it applies to the specific evaluation.
Gross Impacts	Gross Impacts	The change in energy consumption and/or demand that results directly from program-related actions taken by participants in an energy efficiency program, regardless of why they participated.
Attribution of Impacts	Net Impacts	The change in energy consumption and/or demand that is attributable to a particular energy efficiency program. This change in energy use and/or demand may include, implicitly or explicitly, consideration of factors such as free ridership, participant and nonparticipant spillover, and induced market effects. These factors may be considered in how a baseline is defined (e.g., common practice) and/or in adjustments to gross savings values.
	Net-to-Gross Ratio	A factor representing net program savings divided by gross program savings that is applied to gross program impacts to convert them into net program impacts. The factor itself may be made up of a variety of

⁵⁶ A probabilistic statement is not the same as the confidence and precision information calculated based on sampling theory.

⁵⁷ However, a small number of program designs do lend themselves to experimental or quasi-experimental designs that allow for regression analysis of net impacts.

Concept	Term	Definition
		factors that create differences between gross and net savings, commonly including free riders and spillover. The factor can be estimated and applied separately to either energy or demand savings. Note that the net-to-gross ratio (NTGR) = ((1-Free Ridership) + Participant Spillover + Nonparticipant Spillover).
	Core NTGR	1-Free Ridership
	Free Rider	A program participant who would have implemented the program’s measures or practices in the absence of the program. Free riders can be: (1) total, in which the participant’s activity would have completely replicated the program measure; (2) partial, in which the participant’s activity would have partially replicated the program measure; or (3) deferred, in which the participant’s activity would have partially or completely replicated the program measure, but at a future time.
	Spillover	<p>Reductions in energy consumption and/or demand caused by the presence of an energy efficiency program. There can be participant and/or nonparticipant spillover.</p> <p><i>Participant spillover</i> (PSO) is the additional energy savings that occur as a result of the program’s influence when a program participant independently installs incremental energy efficiency measures or applies energy-saving practices after having participated in the energy efficiency program. Evaluated savings associated with Program Administrator Training programs will also be considered Participant spillover.* There are several general categories of participant spillover:</p> <ul style="list-style-type: none"> • <i>Inside spillover</i> (ISO): Occurs when program participants implement additional program-induced energy efficiency measures at the program project site. • <i>Outside spillover</i> (OSO): Occurs when program participants implement program-induced efficiency measures at other sites within the Program Administrator’s service territory at which program project measures were not implemented. • <i>Like spillover</i>: Occurs when program participants implement program-induced efficiency measures of the same type as those implemented through the program. Like spillover can occur at the program project sites (ISO) or at other sites within the Program Administrator’s service territory (OSO). • <i>Unlike spillover</i>: Occurs when program participants implement program-induced efficiency measures of a different type from those implemented through the program. Unlike spillover can occur at the program project sites (ISO) or at other sites within the Program Administrator’s service territory (OSO). <p><i>Nonparticipant spillover</i> (NPSO) refers to energy savings that occur when a program nonparticipant installs energy efficiency measures or applies energy savings practices as a result of a program’s influence.</p>
Markets	Market	The commercial activity (e.g., manufacturing, distributing, buying, and selling) associated with products and services that affect energy use.
	Market Effects	A change in the structure of a market or the behavior of participants in a market that is reflective of an increase (or decrease) in the

Concept	Term	Definition
		adoption of energy efficient products, services, or practices and is causally related to market interventions (e.g., programs). Examples of market effects include increased levels of awareness of energy-efficient technologies among customers and suppliers, increased availability of energy-efficient technologies through retail channels, reduced prices for energy-efficient models, build-out of energy-efficient model lines, and—the end goal— increased market shares for energy-efficient goods, services, and design practices.
	Market Assessment	An analysis that provides an assessment of how and how well a specific market or market segment is functioning with respect to the definition of well-functioning markets or with respect to other specific policy objectives. A market assessment generally includes a characterization or description of the specific market or market segments, including a description of the types and number of buyers and sellers in the market, the key factors that influence the market, the type and number of transactions that occur on an annual basis, and the extent to which market participants consider energy efficiency an important part of these transactions. This analysis may also include an assessment of whether a market has been sufficiently transformed to justify a reduction or elimination of specific program interventions (or whether continued or even increased intervention is necessary). Market assessment can be blended with strategic planning analysis to produce recommended program designs or budgets. One particular kind of market assessment effort is a baseline study, or the characterization of a market before the commencement of a specific intervention in the market for the purpose of guiding the intervention and/or assessing its effectiveness later.

* This definition does not apply to Building Operator Certification (BOC) when using IL-TRM defined prescriptive savings. IL-TRM defined prescriptive savings for BOC are considered net and are not subject to any further NTG adjustment.

Sources: State and Local Energy Efficiency Action Network. 2012. Energy Efficiency Program Impact Evaluation Guide. Prepared by Steven R. Schiller, Schiller Consulting, Inc., www.seeaction.energy.gov; Violette and Rathbun 2014. The Uniform Methods Project: Methods for Determining Energy Efficiency Savings for Specific Measures, Chapter 23: Estimating Net Savings: Common Practices, <http://www.nrel.gov/docs/fy17osti/68578.pdf>.

2.2 Free Ridership-Specific Issues

2.2.1 Survey Design

Free ridership questions, especially questions about the counterfactual, can be challenging to answer and may confuse respondents. To address these challenges, evaluators may use the following survey design strategies:

- Warm up questions
 - Clarification of key terms
- Warm up Questions

Warm up questions preface the counterfactual questions to remind the respondent of their state of mind when they decided on the efficient option. Examples of warm up questions are as follows:

1. How did you first learn about the energy efficient option of this [MEASURE]?
2. How did you first learn about the following features of this energy efficient [MEASURE]:
 - A. The potential to save energy and lower your utility bill?
 - B. The environmental benefits?
 - C. The potential to reduce maintenance costs?

D. The home comfort benefits?

E. The price difference between this energy efficient [MEASURE] and one of standard efficiency?

Responses to warm up questions are not to be used to calculate free ridership. They are intended to improve the quality of responses to free ridership questions by reminding the respondent of their process to choose the energy efficient option.

Clarification of Efficiency Terms

To highlight that free ridership questions focus on the process of choosing an efficient option over one of standard efficiency, evaluators may clarify the terms used to describe the options before asking the questions. For example:

“Next we will ask you about your decision to purchase the energy efficient [measure] instead of one of standard efficiency. By “energy efficient” we mean the equipment performs just as well or better than equipment of standard efficiency, but the energy efficient equipment uses less energy to do so. Energy efficient equipment typically costs more than standard models, but they cost less to operate and often cost less to maintain than standard models do.”

Prefacing counterfactual questions with clarifications of efficiency terms may highlight for the respondent that the questions center on choosing the efficient option – not on the need to replace the existing equipment (with a model of any efficiency).

2.2.2 Supplementing Self-Report with Historical Tracing

For programs with projects that are large, complex, involve multiple decision-makers, and are the result of many decisions made over the course of the project (for example, custom and new construction programs), evaluators may review project documentation to supplement their analysis of self-report survey results. Historical tracing, which involves reconstructing the events that led to the outcome of interest, can support logic to enhance the validity of the free ridership estimation from self-report survey results⁵⁸. By considering additional qualitative and quantitative information, such as project files, documented communication, as well as open-ended survey responses, evaluators may better understand the multiple sources of program attribution and the weight of various decision makers for complex projects. In these instances, evaluators may include a historical tracing approach to add consideration of the multiple decision maker perspectives. Because the process of gathering the appropriate documentation from program teams, implementers, and customers can be burdensome on all parties involved, evaluators should prioritize projects within a given program that would most affect the confidence of the savings-weighted NTG estimate.

2.3 Spillover-Specific Issues

Some issues related to spillover are applicable for both residential and non-residential programs and are discussed in this section.

Spillover is generally categorized into two broad categories – participant spillover and nonparticipant spillover (see Table 2-1). These protocols include two general methods of assessing spillover, one through end-user (or participant/nonparticipant) research and the other through trade ally research. Estimates of participant and nonparticipant research are mutually exclusive, as long as only one of these two general methods is used for a given evaluation period. For example, there is no danger of double-counting spillover if an evaluation includes end-user research with both participants and nonparticipants. Similarly, there is no danger of double-counting spillover if an evaluation includes research with both active and inactive trade allies (see definitions in Section 5.2). However, once end-user research is combined with trade ally research, there is a potential for overlap in the resulting spillover estimates, and care must be taken to avoid double-counting.

Figure 2-1 provides a visual depiction of how the four methods (or “perspectives”) for estimating spillover included in these protocols (participant and nonparticipant self-report, Sections 0 and 4.1; and active and inactive trade ally spillover, Section 5.2) can be used to assess both participant (red) and nonparticipant spillover (green). This figure illustrates that (a) different spillover methods can overlap in the spillover they cover, leading to potential double-

⁵⁸ Violette and Rathbun, *Estimating Net Savings*, 46-48.

counting, and (b) some spillover may not be measured by these methods (as represented by the four corners in the diagram).

Figure 2-1. Example - Types of Spillover and Methods for Assessment

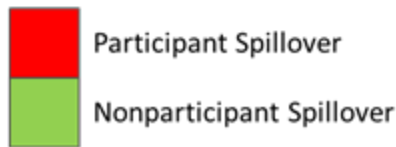
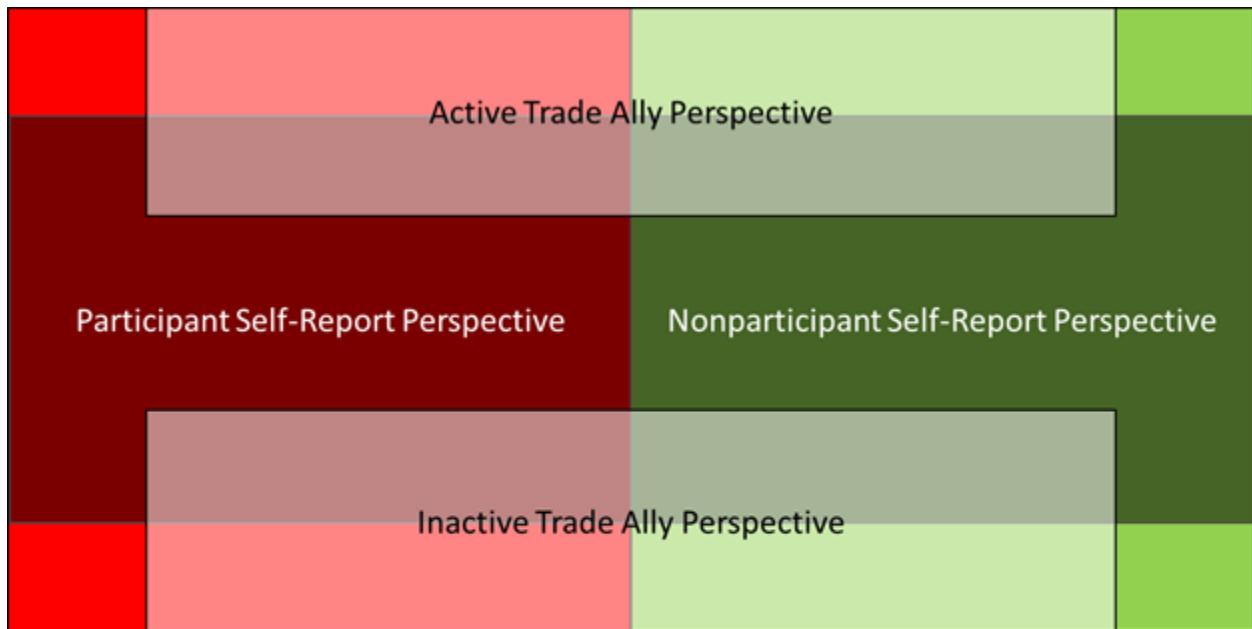

2.3.1 Measure Costs

In order to facilitate analysis of program Total Resource Cost (TRC), estimates of the total incremental measure cost (IMC) at the program level must be developed. IMC values are available for most IL-TRM measures and can be summed to the program level. However, the IMC values for spillover measures could also be estimated and added to this total. The problem is that IMC values for spillover measures can be difficult to estimate. When the magnitude of the savings justifies the effort to estimate the total IMC for spillover measures, the following approaches should be used.

- In cases where the evaluator believes the spillover measure incremental costs are not materially different from the rebated measure incremental costs, the evaluator may multiply the IMC for the rebated measure by the spillover rate to derive the IMC for the spillover measure.
- In cases where the evaluator believes the spillover measure incremental costs are materially different from the installed measure incremental costs (e.g., installation of measures that have no efficiency levels), the evaluator should use the estimated incremental project costs as the IMC for the spillover measure.

Normally, the sample-based estimates of IMCs for spillover measures should be extrapolated to the program level using sample weights. Then the total IMCs for rebated measures and the total IMCs for spillover measures should be summed and used in the TRC calculation.

For measures characterized by the IL-TRM, measure effective useful life (EUL) estimates should be based on the IL-TRM. For measures not characterized by the IL-TRM, evaluator can use either the EUL for similar measures or best professional judgment. In either case, the evaluator must provide the rationale for their choices.

3 Commercial, Industrial, and Public Sector Protocols

The table below lists Illinois non-residential programs and the free ridership protocol applicable to each program.⁵⁹ If the design of a given program changes significantly, then it may mean that the NTG protocol listed for that program in this document is no longer appropriate. If that happens, the evaluator should follow the procedures outlined in Section 1.4: Diverging from the IL-NTG Methods. Note that the Core Non-Residential Spillover protocol described in Section 0 is generally applicable to most of these programs.

Table 3-1. Commercial, Industrial, and Public Sector Programs

Program Administrator	Program Name	Timing Adjustment Formula	Free Ridership Protocol
Ameren Illinois	Custom Initiative	3 Year	3.1 Core Non-Residential Protocol
Ameren Illinois	Midstream Initiative	2 Year	5.4 Midstream Protocol
Ameren Illinois	Retro-Commissioning Initiative	2 Year	3.4 Study-Based Protocol
Ameren Illinois	Small Business Initiative	2 Year	3.1 Core Non-Residential Protocol
Ameren Illinois	Standard Initiative	3 Year	3.1 Core Non-Residential Protocol
Ameren Illinois	Streetlighting Initiative	3 Year	3.1 Core Non-Residential Protocol
ComEd	Assessments	3 Year	3.4 Study-Based Protocol
ComEd	Behavior – Bus/Pub	3 Year	3.4 Study-Based Protocol
ComEd	Incentives	3 Year	3.1 Core Non-Residential Protocol
ComEd	Midstream/Upstream	2 Year	5.4 Midstream Protocol
ComEd	Multifamily (Market rate, common area perspective)	3 Year	3.1 Core Non-Residential Protocol
ComEd	New Construction – Bus/Pub	3 Year	3.3 C&I New Construction Protocol
ComEd	Small Business	2 Year	3.1 Core Non-Residential Protocol
ComEd	Small Business (Small Business Kits component)	2 Year	4.7 Energy Saving Kits and Elementary Education Protocol
ComEd	Streetlighting Initiative	3 Year	3.1 Core Non-Residential Protocol
ComEd	Targeted Systems (RCx, VCx, Industrial Systems)	3 Year	3.4 Study-Based Protocol
Nicor Gas	Business Energy Efficiency Rebates	2 Year	3.1 Core Non-Residential Protocol
Nicor Gas	Business Optimization	2 Year	3.1 Core Non-Residential Protocol
Nicor Gas	Combined Heat and Power	3 Year	3.1 Core Non-Residential Protocol
Nicor Gas	Commercial Food Service Midstream	3 Year	5.4 Midstream Protocol
Nicor Gas	Custom Incentives	3 Year	3.1 Core Non-Residential Protocol
Nicor Gas	Multifamily (Market rate, common area perspective)	3 Year	3.1 Core Non-Residential Protocol
Nicor Gas	Non-Residential New Construction	3 Year	3.3 C&I New Construction Protocol
Nicor Gas	Retro Commissioning	2 Year	3.4 Study-Based Protocol
Nicor Gas	Small Business Program – Incentives/Direct Install/Kits	2 Year	3.1 Core Non-Residential Protocol
Nicor Gas	Strategic Energy Management	3 Year	3.4 Study-Based Protocol

⁵⁹ The “Free Ridership Protocol Name” in the second column of the table refers to the numbered sections in this document, e.g., “3.1 Core Non-Residential Protocol.”

Program Administrator	Program Name	Timing Adjustment Formula	Free Ridership Protocol
Peoples Gas/ North Shore Gas	C&I and PS Custom and Prescriptive Rebates, Direct Install, Partner Trade Ally, Kits, Small and Midsize Business Custom, Direct Install & Assessment, Kits, Partner Trade Ally, Prescriptive, Multifamily (Market rate, common area perspective)	3 Year, Direct Install and Small Business 2 Year	3.1 Core Non-Residential Protocol
Peoples Gas/ North Shore Gas	C&I and PS Gas Optimization	3 Year	3.4 Study-Based Protocol
Peoples Gas/ North Shore Gas	C&I and PS Retro-Commissioning	3 Year	3.4 Study-Based Protocol
Peoples Gas/ North Shore Gas	C&I and PS Strategic Energy Management	3 Year	3.4 Study-Based Protocol
Peoples Gas/ North Shore Gas	Commercial Food Service Midstream	3 Year	5.4 Midstream Protocol
Peoples Gas/ North Shore Gas	MF Gas Optimization	3 Year	3.4 Study-Based Protocol
Peoples Gas/ North Shore Gas	Non-Residential New Construction	3 Year	3.3 C&I New Construction Protocol

3.1 Core Non-Residential Protocol

3.1.1 Core Non-Residential Free Ridership Protocol

Key considerations and guidelines for estimation of free ridership under this Core Non-Residential Free Ridership (FR) protocol are listed below:

- Multiple Questions:** Evaluators will use program participant responses to multiple survey questions as inputs to the free ridership calculation algorithm. Evaluators will not use the response to a single question to establish a survey respondent as either a complete free rider or a complete non-free rider.
- Consistency Checks:** Evaluators should administer survey questions as checks on the consistency of responses associated with a core free ridership assessment methodology. Evaluators may also reference available quantitative and qualitative data, including consistency check data, to perform documented modifications to individual free ridership estimates resulting from the application of a core free ridership assessment methodology.
- Vendor Recommendations:** Vendor recommendations may be important in the influence of a program on customer decision-making. Vendors include trade allies, contractors, distributors, suppliers, and other market actors involved in the selection and installation of program-incented equipment on behalf of the participant. If program logic supports it, evaluators will include vendor recommendations as a program factor when reminding respondents of program components. In addition, evaluators will consider surveying vendors instead of or in addition to participating customers as part of their overall evaluation approach. Should both vendors and customers be surveyed, Section 5.1 describes an approved method to merge the two perspectives for the purposes of developing a program-level free ridership estimate.
- Quality Control Review:** For programs involving large, complex projects and decision-making, after all the survey data collection has been completed and preliminary NTGRs have been computed using the standard calculation procedures, a quality control review should be completed. All quantitative and

qualitative data should be systematically and independently analyzed by a researcher who is familiar with the program, the individual site and the social science theory that underlies the decision maker survey instrument. This researcher should make an independent determination of whether the additional information justifies modifying the previously calculated NTGR score, and if a modification is determined to be necessary, present any recommended modifications and their rationale in a well-organized manner, along with specific references to the supporting data. Circumstances that may justify a revision of the previously calculated NTGR score include: (1) significant inconsistencies exist between separate FR scores that may lead to elimination of FR scores determined to be outliers; (2) the emerging “story” from the qualitative data is in conflict with the quantitative data, thereby requiring a callback to the customer to resolve the inconsistency and a revision to the original scoring based on the new information; or (3) the entire set of results for an interview are inconsistent, the data are too disparate and would not be helped with a callback. In such cases, a recommendation is made to remove that sample point and replace it with a back-up point (if available).

3.1.1.1 Core Free Ridership Scoring Algorithm

The Core Non-Residential FR protocol consists of two scores that measure the program’s impact on efficiency (the Program Influence, or “PI” FR Score and the Counterfactual, or “CF” FR Score), as well as a Quantity and Timing (Q&T) Adjustment that provides credit to the program for increasing the scope of a project or accelerating the timing. The three components are combined as shown in Figure 3-1 to calculate the final free ridership value.

Evaluators will submit participant survey and net savings analysis data to the Illinois NTG Working Group. The group will analyze these data for the purpose of further refining the protocol.

Figure 3-1. Core Free Ridership Algorithm

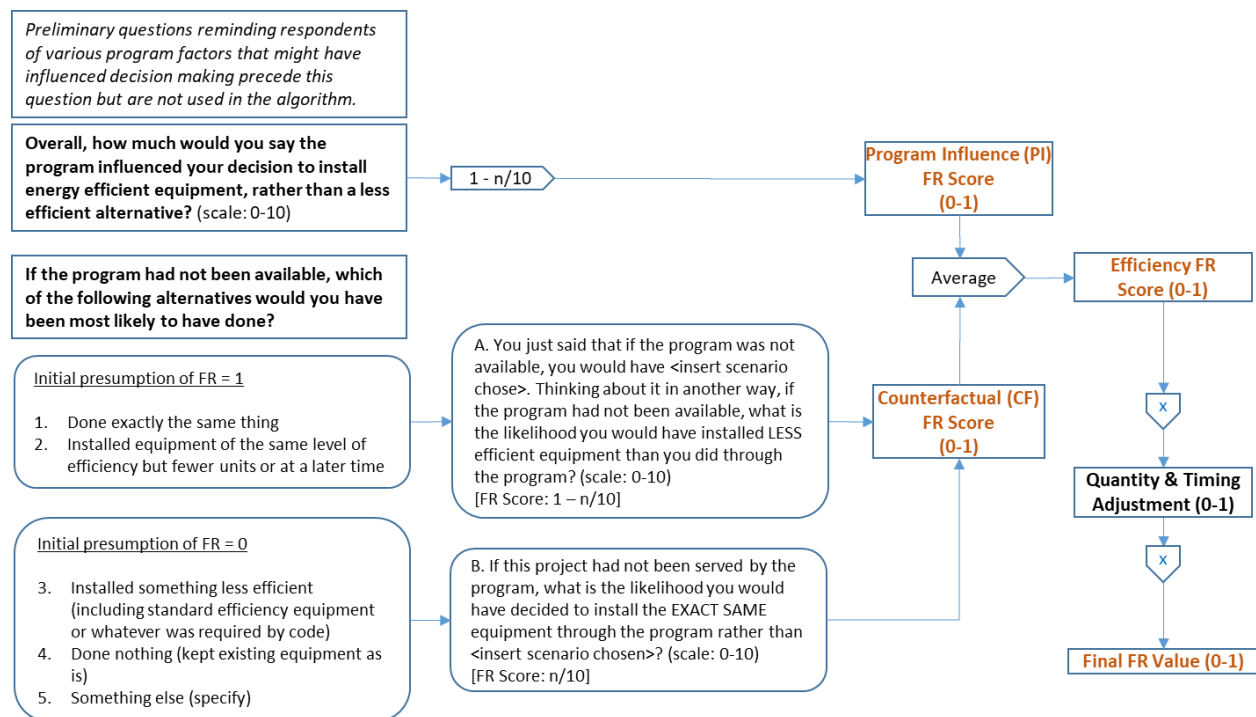

Program Factors

To ensure that the respondent thinks about the program holistically, the survey will first remind the respondent of program factors that might have influenced decision-making. This could be through one or more questions about program factors or through a read-in of program factors.

The factors referenced in the survey will include those that the evaluator determines could potentially impact the participant decision-making process. Evaluators determine these factors based on available information, including

but not limited to discussions with the program management and implementation contractor team, program materials, and program theory or logic model documentation. Program factors may, for instance, include the availability of the program incentive, technical assistance from program partner staff (e.g. trade allies), program staff recommendations, Program Administrator marketing materials, and an endorsement or recommendation by a Program Administrator, account manager or program partner staff.

Evaluators will determine if vendor recommendations should be considered a program factor. This section outlines the rules for the treatment of vendor recommendations.

The evaluator first determines if the program has a qualifying trade ally network. A trade ally network is qualifying if the evaluator determines that the trade ally network meets all of the following criteria:

1. The trade ally network consists of pre-approved, registered trade allies that complete signed agreements or are verified through direct contact with the Program Administrator
2. Registered trade allies are an integral component of program delivery, as supported by program design
3. Registered trade allies receive program-sponsored training

Vendor recommendations are considered a program factor under the following scenario:

- The program has a qualifying trade ally network and the vendor who implemented the project under investigation is currently a registered trade ally, or has been so in the last three years

Vendor recommendations are not considered a program factor under the following scenarios:

- The program does not have a qualifying trade ally network
- The program has a qualifying trade ally network but the vendor who implemented the project under investigation is not a registered trade ally

In cases where vendor recommendations are considered a program factor, the survey shall specifically identify the vendor to the respondent.

Program Influence FR Score

The PI Score measures the overall influence of the program on the participant’s decision to select energy efficient equipment instead of a less efficient alternative. It is developed based on a single question that asks the respondent to rate the overall influence of the program on the decision to install energy efficient equipment using a scale from 0 to 10, with 0 being not at all influential and 10 being extremely influential.

Evaluators will calculate the PI Score for each survey respondent using the following equation:

$$Program\ Influence\ FR\ Score = 1 - \left(\frac{[Influence\ Rating]}{10} \right).$$

This score can range from 0 (no free ridership) to 1 (full free rider).

In cases where vendor recommendations are considered a program factor, the survey shall ask a second Program Influence question that asks the respondent to rate the influence of interactions with the relevant vendor on the decision to install energy efficient equipment using a scale from 0 to 10, with 0 being not at all influential and 10 being extremely influential. In these cases, the PI Score will be calculated using the maximum influence score across the two questions.

Counterfactual FR Score

The CF Score is based on the most likely action the respondent would have taken with respect to the efficiency of the equipment in the absence of the program.

Evaluators will administer a counterfactual scenario survey question, which asks the respondent to identify which alternative among a list they would have been most likely to follow if the program had not been available. The scenarios will be specific to the program, but generally include options such as purchasing less efficient equipment,

doing the same thing they did through the program, or doing nothing at all. The evaluator should explicitly consider if, before the counterfactual survey question is administered, the respondent needs to be reminded of the program factors. If the position of the counterfactual question relative to the initial introduction of program factors as described in Section 3.1.1.1.1 is such that the respondent might plausibly not recall the definition of the program, the evaluator shall remind the respondent of the program factors (including the vendor recommendations if applicable). The respondents will be asked a follow-up likelihood question as illustrated in Figure 3-1. Evaluators will calculate the CF Score for each survey respondent based on responses to the likelihood follow-up questions using one of the following equations, with the selection of the equation based on the initial scenario selected by the respondent:

$$CF\ Score = Likelihood\ would\ have\ done\ less\ efficient = 1 - \left(\frac{[Rating]}{10} \right)$$

OR

$$Likelihood\ would\ have\ done\ same\ efficiency = \left(\frac{[Rating]}{10} \right).$$

Option 2 is an alternative option to be used only in cases where evaluators believe that there is evidence that respondents are not able to understand and correctly answer the likelihood follow-up questions. In Option 2, evaluators will set the CF Score equal to a presumption of FR based on the initial response to the scenario question only. Figure 3-1 provides prescribes initial presumption of FR values for default scenarios. These values are binary and take the form of either no free ridership (CF Score = 0) or total free ridership (CF Score = 1).

If evaluators choose Option 2, they should still report Option 1 scores and provide a rationale for why they believe Option 1 is not appropriate based on available data. Option 2 scores do not need to be reported if Option 1 is chosen, but evaluators may wish to report the scores to enable future dialog in the NTG Working Group as to the form of the Core Non-Residential Free Ridership Protocol.

Both options for calculating the CF Score produce scores that can range from 0 (no free ridership) to 1 (full free rider). Option 2 will lead to CF Score values that are *only* 0 (no free ridership) or 1 (full free ridership).

Consistency Checks

Per the key considerations listed at the beginning of Section 3.1, respondents should be asked one or more questions to facilitate evaluator understanding of responses to the free ridership questions and potentially reconcile apparently inconsistent responses. Some questions may be asked of all respondents; others may be asked when previous answers appear inconsistent. Evaluators should report on the amount of inconsistency encountered, and on the resolution, to inform future protocol revisions. Three recommended consistency checks are outlined below, but evaluators may also incorporate additional consistency checks as they see fit.

Program Influence/Counterfactual Consistency Check

A Program Influence/Counterfactual consistency check is triggered when either of the following conditions are met:

1) The Program Influence FR Score is greater than 0.7 AND the Counterfactual FR Score is less than 0.3.

OR

2) The Program Influence FR Score is less than 0.3 AND the Counterfactual FR Score is greater than 0.7.

Timing of Installation Decision/Level of Program Attribution Consistency Check

The survey should contain a question to ask whether the respondent learned about the program after finalizing project specifications, including, where applicable, equipment efficiency level and number of units. The Timing of Installation Decision/Level of Program Attribution consistency check is triggered by the following conditions being met:

1) A respondent learned about the program after finalizing project specifications

AND

2) The Program Influence FR Score is less than 0.3 OR the Counterfactual FR Score is less than 0.3.

Vendor Influence/Counterfactual Consistency Check

A Vendor Influence/Counterfactual consistency check is triggered when the following conditions are met:

- 1) Vendor recommendations are determined to be a program factor as discussed in Section 0
- 2) The Program Influence FR Score is greater than 0.7 AND the Program Influence FR Score was calculated based on the vendor-specific Program Influence question.

The Counterfactual FR Score is less than 0.3

OR

- 3) Vendor recommendations are determined to be a program factor as discussed in Section 0
- The Program Influence FR Score is less than 0.3 AND the Program Influence FR Score was calculated based on the vendor-specific Program Influence question.

- 4) The Counterfactual FR Score is greater than 0.7

Quantity and Timing Adjustment

The Q&T Adjustment can reduce the Efficiency FR Score in cases where the program influenced a respondent to expedite all or parts of their project (compared to when they would have completed it without the program). The Q&T Adjustment can range from 0 to 1, where a lower value means a greater FR reduction (i.e., more credit to the program). As shown in Figure 3-1, the Q&T Adjustment is multiplied by the Efficiency FR Score to derive the final FR values.

Quantity adjustments are applicable to equipment measures where 2 or more units are installed, and to all upgrades that have a length or area component (such as air sealing or insulation). When quantity adjustments are applicable, evaluators will first ask respondents how much (in percentage terms) of the installed energy-efficient equipment would have been installed at the same time without the program. Only the quantity that would not have been installed at the same time is eligible to receive the Q&T credit. Evaluators then ask if the respondent would have installed the remaining quantity later and, if so, how much later. When quantity is not applicable, respondents are only asked if they would have installed the equipment later, and if so, how much later.

The timing question will present a series of date ranges (e.g., within one year, between 12 months and 2 years, etc.) and ask the respondent to pick one representing their best estimate of when the measure(s) would have been implemented in the absence of the program. However, program specific timing adjustments have been established, as shown in Figure 3-1, and use the following formulas:

$$2\text{-year Time Horizon Timing Adjustment} = 1 - (\text{Number of Months Expedited} - 6)/18$$

$$3\text{-year Time Horizon Timing Adjustment} = 1 - (\text{Number of Months Expedited} - 6)/30$$

The Timing Adjustment can range from 0 to 1. A smaller value means a greater reduction in FR, because the program resulted in a greater acceleration of the project. The Q&T Adjustment is then calculated as follows:

$$Q\&T\ Adjustment = (\% \text{ Not Installed at Same Time} * \text{Timing Adjustment}) + \% \text{ Installed at Same Time}$$

3.1.1.2 Construction of Core Free Ridership Value

Evaluators will calculate final FR values in the following manner:

$$\text{Core FR Algorithm} = \text{AVERAGE}([\text{Program Influence FR Score}], [\text{Counterfactual FR Score}]) * [\text{Quantity \& Timing Adjustment}]$$

The Core FR Algorithm is graphically presented in Figure 3-1.

Core Non-Residential Spillover Protocol

Spillover refers to energy savings associated with energy-efficient equipment installed by consumers who were influenced by an energy efficiency program, but without direct intervention (e.g., financial or technical assistance) from the program.

To place the spillover protocols in context, we begin by defining the NTGR as:

$$\text{NTGR} = (1 - \text{Free Ridership Value} + \text{PSO Rate} + \text{NPSO Rate})$$

Where:

PSO Rate = Participant spillover rate

NPSO Rate = Nonparticipant spillover rate

The term (1-Free Ridership) is referred to as the Core NTGR for an efficiency program.

3.1.2 Core Participant Spillover Protocol

The Core Participant Spillover protocol is generally applicable to most commercial, industrial, and public sector programs.

3.1.2.1 Research Methods

Data collection approach. An initial determination of participant spillover may be made based on self-reported findings from surveys of program participants. At a minimum, surveys collecting data pertaining to participant spillover will obtain general information on the specific measures installed and information substantiating their attribution to an energy efficiency program. Research on the specific characteristics of the energy efficient equipment installed and the baseline and operating conditions needed to estimate savings may be done in one of two ways: 1) a detailed battery of measure specific questions may be administered as part of the initial survey; or 2) a separate in-depth follow-up interview may be conducted by the engineer or analyst responsible for the energy savings calculation. In either case, an engineer or analyst will use the collected data to develop an estimate of spillover savings for each project.

Sample Frame. One target for participant spillover research may be the most recent year’s program participants who have been sampled for free ridership or process surveys. In the case where a stand-alone spillover study is being conducted, the sample frame may be broader and include those whose participation occurred during the time period of two prior program years.

Because evaluated spillover energy impacts associated with the sample are being extrapolated to the program population, it is important that the sample frame be limited to participating customers for which spillover may potentially be claimed.

Sample frames should be constructed in accordance with the following guidelines:

- Self-directing customers as defined by 220 ILCS 5/8-104(m) should be excluded from the sample frame for natural gas spillover.
- Customers of municipal electric utilities should be excluded from the sample frame for electric spillover.

Timing of Data Collection. Evaluators may either administer the participant spillover module as part of a comprehensive net-to-gross survey, or they may elect to implement it separately. A follow-up in-depth interview may also be conducted by an engineer or analyst to obtain additional details needed to quantify savings. Optimally, the spillover inquiry should be timed in order to allow sufficient time for spillover to occur; at a minimum, three months after the program-incented measure is installed. Projects installed up to two years after program participation occurred may be counted as spillover, provided it can be substantiated.

3.1.2.2 Approach for Identifying and Quantifying Spillover

Attribution Criteria. Program attribution is determined by the responses to the following two survey questions:

1. How important was your experience in the <PROGRAM> in your decision to implement this measure, using a scale of 0 to 10, where 0 is not at all important and 10 is extremely important?
2. If you had not participated in the <PROGRAM>, how likely is it that your organization would still have implemented this measure, using a 0 to 10 scale, where 0 means you definitely WOULD NOT have implemented this measure and 10 means you definitely WOULD have implemented this measure?

The response to the first question cited above is “Measure Attribution Score 1,” and the response to the second question cited above is “Measure Attribution Score 2.”

There are two methods by which the attribution may be calculated:

1. Program attribution is established if the average of Measure Attribution Score 1 and (10 – Measure Attribution Score 2) exceeds 5.0⁶⁰; either the Measure Attribution Score 1 or (10 – Measure Attribution Score 2) could be below 5.0—as long as the average is greater than 5.0, the threshold is met. If the average is greater than 5.0, 100% of the measure energy savings referenced in the question are considered to be attributable to the program. If the average is not greater than 5.0, none of the measure energy savings are considered to be attributable to the program.
2. An attribution rate may be calculated as equal to the sum of Measure Attribution Score 1 and (10 – Measure Attribution Score 2), divided by 20. For instance, if the attribution rate is 0.3, then 30% of the measure energy savings referenced in the question are considered to be attributable to the program.

Program attribution option 2 must be used in cases in which evaluators have performed the data collection and analysis required to attribute energy savings using option 2 identified above.

Calculation of Spillover Measure Energy Savings. Energy savings of spillover measures shall be calculated in one of two ways.

1. Those addressed in the IL-TRM shall be calculated in accordance with the methods and algorithms specified in the IL-TRM, and shall reference the IL-TRM-defined time-of-sale or new construction baseline.
2. For measures not addressed in the IL-TRM, evaluators shall quantify savings using accepted industry-wide savings methods that conform to IPMVP or other industry protocols and documents.

Evaluators will make every effort to ensure that there is no double-counting of participant spillover energy savings across multiple sources of participant and nonparticipant spillover (such as participating customer and trade ally surveys) and will document that effort.

Measure implementation must have occurred within one year of the participant spillover study data collection effort in order to be countable as participant spillover.

For the purposes of accounting for spillover savings attributable to a program, spillover will only be quantified for measures implemented within the Program Administrator’s service territory.

3.1.2.3 Key Participant Spillover Survey Questions

The Participant Spillover question module is designed to be a general inquiry that seeks to: (1) assess whether additional energy efficiency improvements were implemented since the rebated project was completed; (2) confirm that these measures either had not received program incentives, or that there were no plans to submit them for program incentives in the future; (3) gather basic information about the additional energy efficiency measures (e.g., their type, size, quantities, and energy efficiency rating); and (4) establish program attribution.

The basic question structure is shown below. The measure-specific questions can be repeated in order to capture multiple measures. Note that there is considerable flexibility to tailor the questions to specific types of applications and programs.

1. Since your participation in the <PROGRAM>, did you implement any ADDITIONAL energy efficiency improvements at this facility or at your other facilities within <PROGRAM ADMINISTRATOR>’s service territory that did NOT receive incentives through <PROGRAM>?

⁶⁰ Note that the threshold value for counting spillover has been lowered from 7.0 to 5.0. The rationale for this lower threshold is: (1) the value of >5 is a strong indicator of program influence on the decision to install non-rebated equipment and is currently being used in other states (e.g., California); (2) the previous value of >7 set an unreasonably high standard for demonstrating program influence on the decision to install non-rebated equipment; and (3) past IL evaluation data show that a threshold of >5 will improve spillover estimates as it provides a better approximation of partial spillover (i.e., where a portion of the savings for each measure installed outside the program gets credited as spillover based upon the program influence rating).

2. What measures did you implement without an incentive?

MEASURE-SPECIFIC QUESTIONS [repeated for each spillover measure]⁶¹

1. How important was your experience in the <PROGRAM> in your decision to implement this <MEASUREX>? Please use a scale of 0 to 10, where 0 is not at all important and 10 is extremely important.
2. Can you explain how your experience with the <PROGRAM> influenced your decision to install this additional high-efficiency measure?
3. If you had not participated in the <PROGRAM>, how likely is it that your organization would still have implemented <MEASURE>? Please use a 0 to 10, scale where 0 means you definitely WOULD NOT have implemented this measure and 10 means you definitely WOULD have implemented this measure.
4. How many of <MEASURE> did you install?³
5. Questions to further define the measure (as applicable):
 - a. Type
 - b. Efficiency
 - c. Size
 - d. Other attributes
6. Can you briefly explain why you decided to install this energy efficiency measure on your own, rather than going through the <PROGRAM>?

Since spillover is best conceptualized as a program-level concept, the preferred approach is to ask the influence questions (Q.1-3 above) relative to the participant’s experience with the *program*, rather than relative to the participant’s experience with a specific *project* or *incented measure* (in cases where a unique participant implemented more than one project/measure through the program during the evaluation period).

3.1.2.4 Reporting of Results

Evaluators will report the following information relating to participant spillover data collection and analysis in annual EM&V reporting: 1) the number of participants surveyed; 2) the number of survey respondents reporting additional energy efficiency improvements; 3) the number of survey respondents who meet the spillover attribution threshold; 4) the number of respondents for which spillover savings were actually quantified; 5) the spillover savings for each respondent and overall; and 6) the spillover rate. The term (1-Free Ridership) is referred to as the Core NTGR.

The report summarizing spillover should also describe the means by which the participant spillover rate is calculated.

The preferred approach is to estimate program spillover effects by summing spillover estimates for the sample and dividing this sum by the total ex ante or ex post (if available) gross savings for all projects completed by the respondents in the sample to produce the participant spillover rate. This participant spillover rate can be added to the Core NTGR for the sample to yield the NTGR. If the sample is stratified, sampling weights must be applied before applying the NTGR to the ex post gross savings of the participant population.

Using this approach, the participant spillover rate is calculated using the following formula:

$$\text{Participant Spillover Rate} = \frac{\text{ISO} + \text{OSO in sample}}{\text{Ex Post Gross Impacts for all projects by respondents in sample}}$$

Where:

ISO = Inside participant spillover

OSO = Outside participant spillover

An alternative method is to add the participant spillover rate to each project’s Core NTGR. The project-level NTGRs are then weighted by each project’s ex ante or ex post (if available) gross savings as a share of the total. This savings-weighted NTGR can then be applied to the ex post gross savings of the participant population. If the sample is

⁶¹ Example questions to gather engineering information to support the calculation of spillover savings may be accessed here: http://www.ilsag.info/il_ntg_methods.html

stratified, sampling weights must be applied before applying the NTGR to the ex post gross savings of the participant population. If this method is chosen, the influence questions (Q.1-3 above) must be asked relative to the participant’s experience with a specific *project* and the following formula is used:

$$\text{Participant Spillover Rate} = \frac{\text{ISO} + \text{OSO in sample}}{\text{Ex Post Gross Impacts for all sampled projects}}$$

Irrespective of the approach used to calculate the participant spillover rate, it is essential that the wording of the influence questions (i.e., whether relative to the participant’s experience with the *program* or relative to the participant’s experience with a specific *project or incented measure*) match the impacts included in the denominator of the participant spillover rate.

3.1.3 Core Nonparticipant Spillover Protocol

The evaluation may perform research to measure nonparticipant spillover (NPSO). Evaluators will make efforts to ensure that there is no double-counting of energy savings across multiple sources and will document those efforts.

3.1.3.1 Core Nonparticipant Spillover Protocol – Measured from End Users

NPSO for end users is defined as the energy savings that are achieved when a nonparticipant end user—as a result of the influence of a Program Administrator’s programs—implements energy efficiency measures *outside* of the Program Administrator’s programs.

One option for the evaluator would be to survey nonparticipating customers and estimate spillover savings for any efficient measures installed that respondents are able to attribute to specific Program Administrator programs. However, in many cases, nonparticipants might find it difficult, if not impossible, to reliably attribute any of their installations to the influence of a specific Program Administrator program. If an evaluator suspects that nonresidential nonparticipants will not be able to reliably attribute spillover savings to any particular Program Administrator program, a second option would be to survey nonparticipants and estimate spillover savings from the installation of efficient measures that respondents are able to attribute to their general knowledge of the Program Administrator incentives and information, regardless of the particular program source. These protocols are written assuming that the NPSO for end users will be estimated using this second option.

Note that this protocol does not address estimating spillover for upstream and midstream programs where the end user is assumed to be completely ignorant of any Program Administrator influence. Of course, when considered feasible, evaluators are free to estimate spillover and spillover rates at the program-specific level with the suggested questions presented in Section 3.2.2.1.2 modified appropriately.

Research Methods

Data Collection Approach. An initial determination of spillover may be made based on self-reported findings from surveys of nonparticipants. At a minimum, surveys collecting data pertaining to nonparticipant spillover will obtain general information on the specific measures installed and information substantiating the influence of the Program Administrator on the installation decision. Research on the specific characteristics of the energy efficient equipment installed and the baseline and operating conditions needed to estimate savings may be done in one of two ways: (1) a detailed battery of measure specific questions may be administered as part of the initial survey, or (2) a separate in-depth follow-up interview may be conducted by the engineer or analyst responsible for the energy savings calculation.⁶² Projects installed within the last two years of the nonparticipant spillover study data collection effort may be counted as spillover, provided program attribution and energy savings can be substantiated. In either case, an engineer or analyst will use the collected data to develop an estimate of spillover savings for each project.

Sample Frame. The sample frame for nonparticipant end user spillover research is composed of customers who have not participated in any programs within the last three years. Because evaluated spillover savings associated with the sample are being extrapolated to the nonparticipant population, it is important that the sample frame be limited to nonparticipants for whom spillover may potentially be claimed.

⁶² See http://www.ilsag.info/il_ntg_methods.html for detailed example questions designed to collect information required to estimate spillover savings for a variety of measures.

Sample frames should be constructed in accordance with the following guidelines:

- Exempt electric customers as defined by 220 ILCS 5/8-103B(k)(1) should be excluded from the sample frame for electric spillover.
- Self-directing customers as defined by 220 ILCS 5/8-104(m) should be excluded from the sample frame for natural gas spillover.
- Customers of municipal electric utilities should be excluded from the sample frame for electric spillover.

Timing of Data Collection. Evaluators might administer the nonparticipant end user spillover study in parallel with the program impact evaluation, potential study or saturation study research, or at a different time.

Approach for Identifying and Quantifying Spillover

Key Nonparticipant Spillover Survey Questions. The nonparticipant end user spillover question module is designed to be a general inquiry that seeks to: (1) assess whether additional energy efficiency improvements were implemented during the study period; (2) confirm that these measures had not received program incentives and that there were no plans to submit them for program incentives in the future; (3) gather basic information about the additional energy efficiency measure(s), e.g., the type, size, quantities, and energy efficiency rating; and (4) establish the Program Administrator importance ratings. Note that while the example questions can be customized to assess the influence of a specific program in the Program Administrator portfolio, they are currently worded to capture influence of the Program Administrator, regardless of program source.

Below are example questions that might be used in a nonparticipant spillover survey. They are grouped by the following topics:

- **Threshold conditions:** Is there some credible evidence that it was at least possible for the Program Administrator to have influenced the decision to install additional energy efficient measures?
- **Measure description:** Enough information needs to be collected for the measure and its operation to support a credible estimate of savings
- **Attribution:** Is there credible evidence that the Program Administrator had substantial influence on the end user's decision to install the efficient measure outside of any of the programs in the Program Administrator portfolio?

Threshold Conditions. Spillover cases are identified using a threshold approach in which certain minimal conditions must be met for a customer's installation to be considered for spillover. The following are example questions that evaluators may use (individually or in combination) to determine that program administrator influence on the installation is possible:

1. Before installing these measures, did you know that <PROGRAM ADMINISTRATOR> offers energy efficiency programs, incentives, and information to help their business customers make energy efficiency improvements at their facilities?
2. <PROGRAM ADMINISTRATOR> offers incentives for energy efficient equipment upgrades and improvements through its <PORTFOLIO NAME> programs. Before installing these measures, had you heard about the <PORTFOLIO NAME> programs?

If the answer to either question is "yes", then the threshold condition is met.

Measure Description. The interview (either the initial interview or a separate in-depth follow-up interview) can be used to determine the following basic attributes (as applicable) required to support a credible estimate of savings:

1. Type
2. Efficiency
3. Size
4. Other attributes

The named measure(s) must represent equipment that is more energy efficient than either: (1) equipment required by codes or standards; (2) industry-standard practice for certain types of equipment; or (3) for Custom measures, the minimum efficiency equipment available to meet the customer's requirements. For detailed example questions

designed to collect engineering information required to estimate spillover savings for a variety of measures, see http://www.ilsag.info/il_ntg_methods.html.

Attribution. The following questions are suggested to assess attribution. These questions should be asked separately for each potential spillover measure:

1. Earlier you mentioned that you knew that <PROGRAM ADMINISTRATOR> offers incentives to customers for installing energy efficient equipment, and also provides information to customers to help them reduce their energy usage. Thinking about all of the reasons you chose to install the energy efficient <MEASURE>, did your knowledge of these incentives and information available through <PROGRAM ADMINISTRATOR> have ANY INFLUENCE on your decision to install <MEASURE>?

ASK IF Q1=YES

2. Using a scale of 0 to 10, where 0 is not at all influential and 10 is extremely influential, how much influence did your knowledge of the incentives and information <PROGRAM ADMINISTRATOR> offers have on your decision to install your energy efficient <MEASURE>?
3. Just to make sure that we understand you correctly, please answer the following hypothetical question. If you had you NOT known about the incentives and information <PROGRAM ADMINISTRATOR> offers, would you still have installed your energy efficient <MEASURE>? Please use a scale of 0 to 10, where 0 means you definitely WOULD NOT have installed your energy efficient <MEASURE> and 10 means you definitely WOULD have done so.

Consistency Checks

Respondents may be asked one or more questions to facilitate understanding and potentially reconcile apparently inconsistent responses. Evaluators should report on the amount of inconsistency encountered and, on the resolution, to inform future protocol revisions.

ASK IF Q2>7 AND Q3>7 OR Q2<3 AND Q3<3

4. In your own words, can you explain HOW your knowledge of the incentives and information <PROGRAM ADMINISTRATOR> offers influenced your decision to purchase or install your energy efficient <MEASURE>?

The evaluation analyst will assess the response to this open ended question and its consistency with the other questions, and, if warranted based on clear additional information, they will adjust the score based on expert judgment. If an inconsistency exists and the open-ended response does not resolve the inconsistency, the respondent will be removed from the calculation. All instances of this occurring should be documented in the final report. Additional consistency checks, triggered and resolved within the survey with additional questions to participants, remain optional.

Nonparticipant End User Spillover Algorithm. The response to question #2 cited above is “Measure Attribution Score 1,” and the response to question #3 cited above is “Measure Attribution Score 2.”

There are two methods by which the attribution may be calculated:

1. Provided that the open-ended responses do not contradict influence of the Program Administrator, spillover is considered to be attributable to the Program Administrator if the average of the Measure Attribution Score 1 and $(10 - \text{Measure Attribution Score 2})$ exceeds 5.0⁶³; either the Measure Attribution Score 1 or $(10 - \text{Measure Attribution Score 2})$ could be below 5.0—as long as the average is greater than 5.0, the threshold is met. If the average is greater than 5.0, 100% of the measure energy savings referenced in the question are considered to be attributable to the Program Administrator. If the average is not greater than 5.0, none of the measure energy savings are considered to be attributable to the Program Administrator.
2. Provided that the open-ended responses do not contradict influence of the Program Administrator, the attribution rate is calculated as equal to the sum of Measure Attribution Score 1 and $(10 - \text{Measure Attribution Score 2})$, divided by 20. For instance, if the attribution rate is 0.3, then 30% of the measure

⁶³ Note that the same 5.0 threshold value is being used for both Participant and Nonparticipant Spillover.

energy savings referenced in the question are considered to be attributable to the Program Administrator.

Calculation of Spillover Measure Energy Savings. Energy savings of spillover measures shall be calculated in one of two ways.

1. Those addressed in the IL-TRM shall be calculated in accordance with the methods and algorithms specified in the IL-TRM, and shall reference the IL-TRM-defined time-of-sale or new construction baseline.
2. For measures not addressed in the IL-TRM, evaluators shall quantify savings using accepted industry-wide savings methods that conform to IPMVP and other industry protocols and documents.

Evaluators will make every effort to ensure that there is no double-counting of nonparticipant spillover energy savings across multiple sources of nonparticipant spillover reporting (such as nonparticipating customer and trade ally surveys) and will document that effort.

Measure implementation must have occurred within the last two years of the nonparticipant spillover study data collection effort in order to be countable as nonparticipant spillover.

For the purposes of accounting for spillover savings attributable to the Program Administrator, spillover will only be quantified for measures implemented within the Program Administrator’s service territory.

Reporting of Results

Evaluators will report the following information relating to nonparticipant spillover data collection and analysis in annual EM&V reporting: 1) how the sample frame was defined, 2) the number of customers surveyed; 3) the number of survey respondents reporting spillover; 4) the number of survey respondents who meet the spillover attribution threshold; 5) the number of respondents for which spillover savings were actually quantified; 6) the spillover savings for each project and overall; 7) the nonparticipant spillover rate, and 8) the calculation of the weights used to extrapolate the spillover to the population of nonparticipants from which the sample was drawn.

The EM&V report should also describe the means by which the nonparticipant spillover (NPSO) rate is calculated. For each sampled site, the verified spillover savings should be summed across measures to derive the total end user NPSO for the sampled sites.⁶⁴ The estimate of site-level end user NPSO for the entire sample is then extrapolated to the entire nonparticipant population using sampling weights.

There are two options for using the estimated NPSO.

1. Allocate the portfolio-level spillover savings to individual programs in the portfolio based on each program’s share of the ex post gross savings. For each program, the spillover rate could then be calculated for each program using the equation below in which the spillover allocated to each program would be the numerator and the ex post program-specific gross savings would be the denominator.

$$Program - Specific\ NPSO\ Rate = \frac{NPSO_{Program-Specific}}{Ex\ Post\ Gross\ Impacts_{Program-Specific}}$$

The spillover-adjusted NTGR for each program could then be used to adjust the Core NTGR for each program before calculating the TRC. In calculating the Program-Specific NPSO Rate, the numerator and denominator must be consistent in terms of the time period of measure implementation/potential implementation. While this time period must be within the last two years, it may be for a period of less than two years.

2. The NPSO Rate is calculated at the Sector level. The estimated energy savings associated with program-attributable spillover measures implemented during the study period by the entire nonparticipant population is divided by the ex post gross impacts for all the nonresidential programs in the portfolio occurring during the study period. The C&I Sector NPSO Rate is calculated using the following equation

$$Portfolio\ NPSO\ Rate = \frac{NPSO_{Portfolio}}{Ex\ Post\ Gross\ Impacts_{Portfolio}}$$

The NPSO rate could then be used to adjust the portfolio core NTGR before calculating the portfolio TRC. Again, in calculating the Portfolio NPSO Rate, the numerator and denominator must be consistent in terms of the time period

⁶⁴ This includes all samples sites including those that reported no spillover savings.

of measure implementation/potential implementation. While this time period must be within the last two years, it may be for a period of less than two years.

C&I New Construction Protocol

3.1.4 Free Ridership

The FR algorithm for non-residential new construction programs will generally follow the Core Non-Residential FR protocol, with a few exceptions as illustrated in Figure 3-X. First, the algorithm includes a direct accounting of past participation for respondents who confirm having previously participated in the New Construction program. Second, the counterfactual scale question will accommodate responses at a sub-project level (e.g., at a measure or end use level of granularity). Third, there is no timing adjustment factor.

Figure 3-2. C&I New Construction Protocol

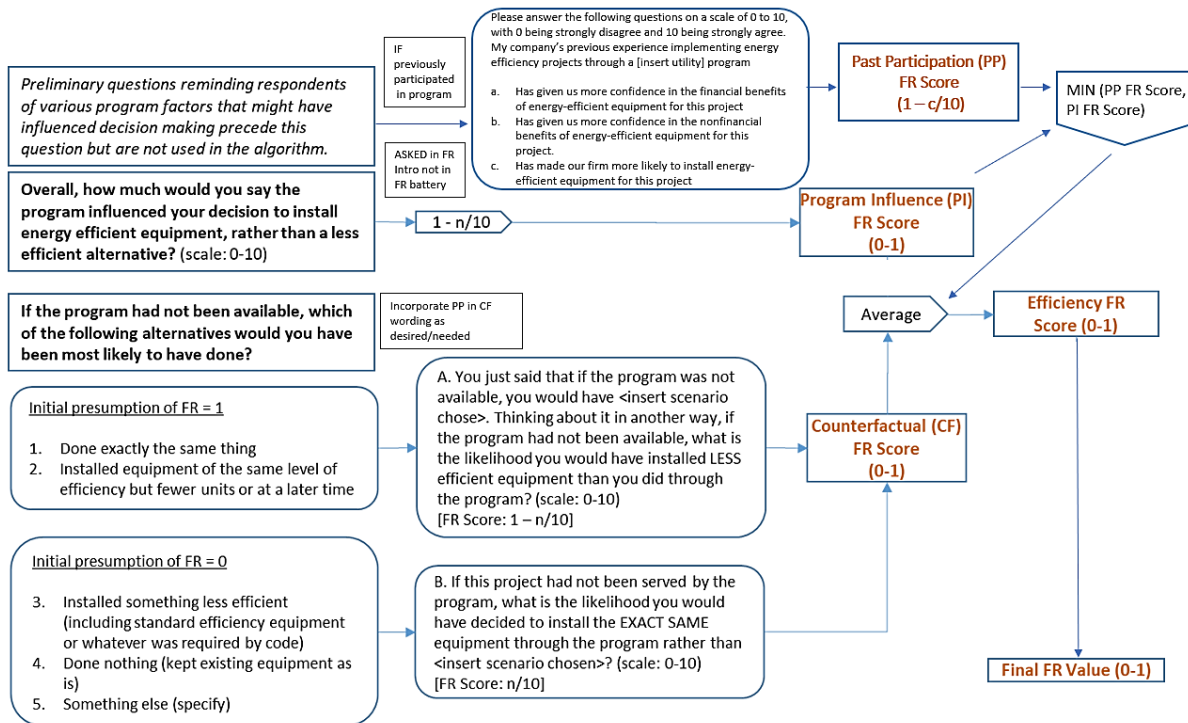

PRIOR PARTICIPATION

Respondents will confirm prior participation early in the survey or interview. For prior participants, evaluators should ask participants to what extent they agree or disagree (using a scale of 0 to 10, with 0 being “strongly disagree” and 10 being “strongly agree”) with the fact that their previous experience implementing energy efficiency projects through the New Construction program:

- a. Has given them more confidence in the financial benefits of energy-efficient equipment for the project in question;
- b. Has given them more confidence in the nonfinancial benefits of energy-efficient equipment for the project in question; and
- c. Has made their company more likely to install energy-efficient equipment for the project in question.

The Past Participation (PP) FR Score will be developed based on a participant’s responses to question (c) above (i.e., whether their company was more likely to install energy-efficient equipment for the particular project due to their previous experience with the program). Evaluators will calculate the PP FR Score using the following formula:

$$\text{Past Participation (PP) FR Score} = 1 - \frac{PP(c)}{10}$$

This score can range from 0 (no free ridership) to 1 (full free rider). For prior participants, evaluators will use the minimum FR score between the PI FR Score and the PP FR Score for that project. For those who have not previously participated in the program, the PI FR Score will be used (similar to the core algorithm).

COUNTERFACTUAL GRANULARITY

The development of the Counterfactual FR Score for C&I New Construction projects cannot be implemented at the project level due to these projects generally including multiple components with different decision-making. As such, evaluators should allow respondents to provide answers (and scores) to the counterfactual follow-up questions **at the measure or end-use level**. As such, these counterfactual follow-up questions will allow for partial effects. The counterfactual scenario question can still be asked at the overall project level, and it should remind respondents to consider their past participation in the program as needed/applicable.

TIMING ADJUSTMENT

Finally, the concept of project timing and deferred free ridership is not applicable to new construction projects.⁶⁵ As a result, the timing adjustment detailed in Section 3.1.1.1. will not be included in the free ridership estimation for new construction projects.

3.2 Study-Based Protocol

3.2.1 Free Ridership

The FR algorithm for non-residential study-based programs (See Figure 3-4) will follow the Core Non-Residential FR protocol, with the following exceptions:

Quantity adjustments are not applicable in the Q&T Adjustment.

- The scenario questions used to develop the Counterfactual FR Score in the Core Non-Residential FR protocol will be preceded by questions to determine the familiarity of upgrades found through the study and ability to address them absent the program, as illustrated below in questions Q1 – Q3b.⁶⁶
- Q.1 A 0-10 scale question about the likelihood that the participant would have conducted the study absent the program will be included when the study is the incented service (i.e., RCx, IS), but not for pay for performance programs (i.e., VCx).

At the measure-group level, the following should be included:

- Q.2a A yes/no question to determine if the participant performs regular maintenance on the equipment treated through the program
- Q.2b If the response to Q.2a is “yes,” a yes/no question to determine if the maintenance always includes the treatment provided through the program
- Q.3a A yes/no question to determine if the participant had prior awareness of the performance issues identified through the study
- Q.3b A 0-10 scale question about the participant’s level of familiarity with the recommended actions to rectify the performance issue.

⁶⁶ It should be noted that the question numbering in Figure 3-5 and Figure 3-6 is for reference purposes only; the additional questions do not have to immediately precede the counterfactual likelihood question.

The scenario question will be asked at the measure-group level. Measure-group level responses will be aggregated to the project level, using savings-based weights.

There will be two options for developing the Counterfactual FR Score:⁶⁷

1. The measure-group level Counterfactual FR Score will be developed following Algorithm 1 of the Core Non-Residential FR approach, using responses to the scenario question.
2. The measure-group level No-Program FR Scores will be assigned, based on responses to Q.1, Q.2b, Q.3a, and Q.3b, as follows:
 - a. If Q.2b = Yes, then Counterfactual FR Score = 1. This assumes that if the participant performs regular maintenance on the treated equipment and that maintenance always includes the issue addressed through the program, then the participant is a full free rider for that measure group for purposes of calculating the Counterfactual FR Score.
 - b. If Q.3a = No and Q.1 = 0 and Q.2b ≠ Yes, then Counterfactual FR Score = 0. This assumes that if the participant was not aware of the performance issue and had a zero likelihood of performing the study absent the program and their maintenance practices do not always include the issue addressed through the program, then the participant is not a free rider for that measure group for purposes of calculating the Counterfactual FR Score since they would not have found out about the issue absent the program.
 - c. If Q.3b = 0 and Q.1 = 0 and Q.2b ≠ Yes, then Counterfactual FR Score = 0. This assumes that if the participant had no familiarity with how to rectify the performance issue, had a zero likelihood of performing the study absent the program, and their maintenance practices do not always include the issue addressed through the program, then the participant is not a free rider for that measure group for purposes of calculating the Counterfactual FR Score since they would not have known how to address the issue absent the program.
 - d. For all other combinations of responses to Q.1, Q.2b, Q.3a, and Q.3b, the measure-group level Counterfactual FR Scores will be developed following the Core FR approach, using responses to the scenario question.

Figure 3-3. Study-Based Free Ridership—Overview

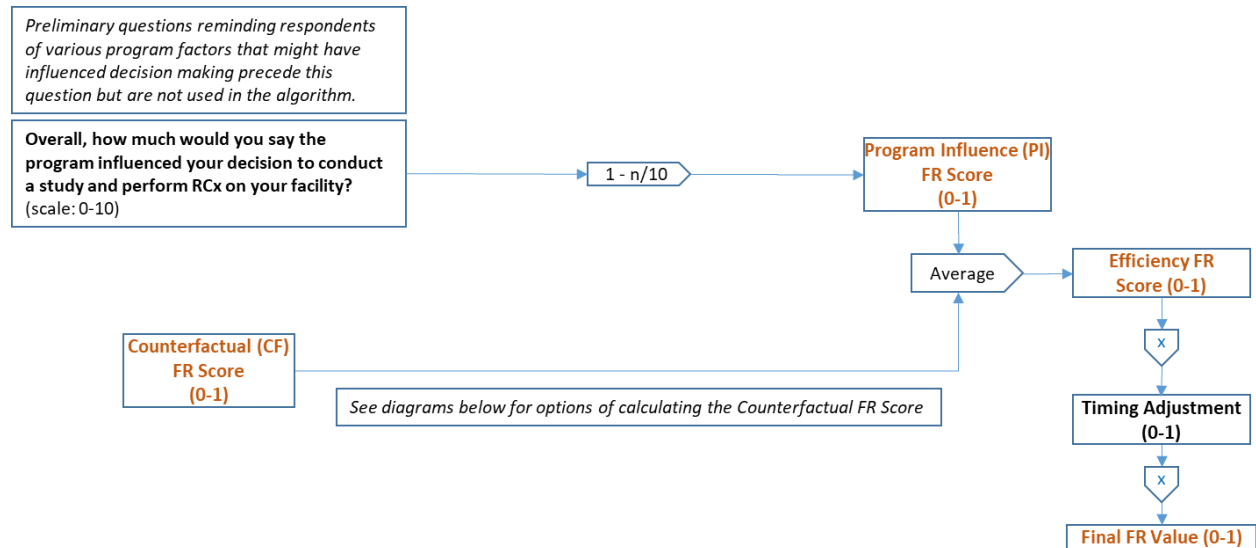

⁶⁷ Option 1 shall be used in all cases for Virtual Commissioning™ programs.

Figure 3-4. Study-Based Free Ridership—No-Program FR Score Option #1

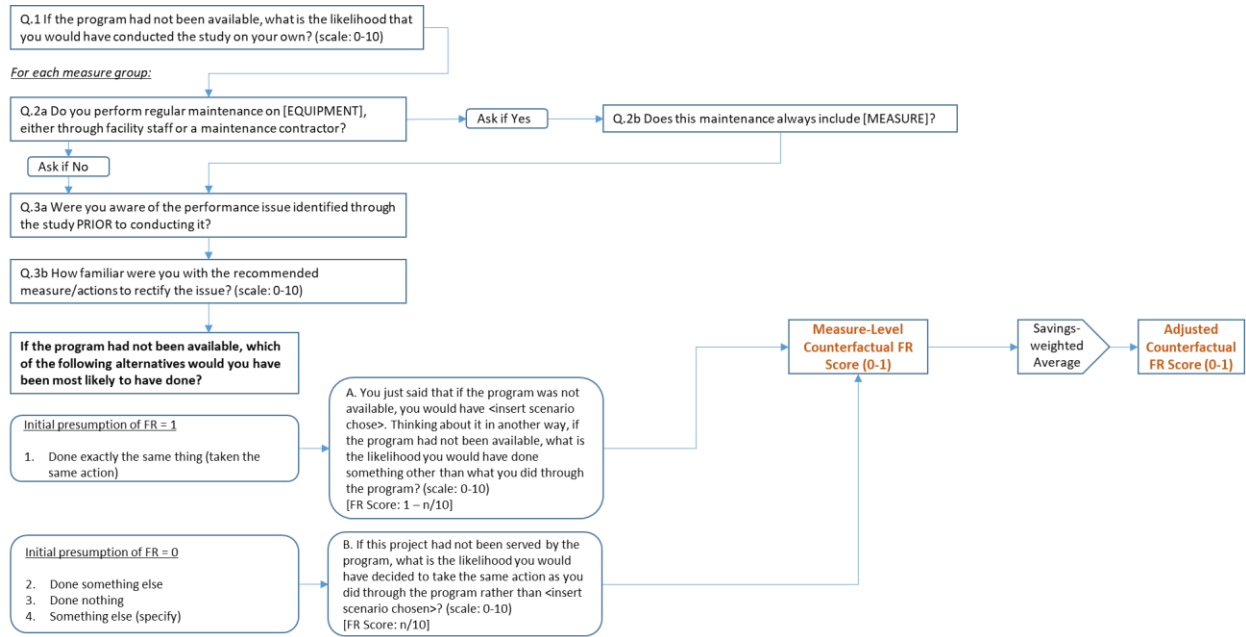
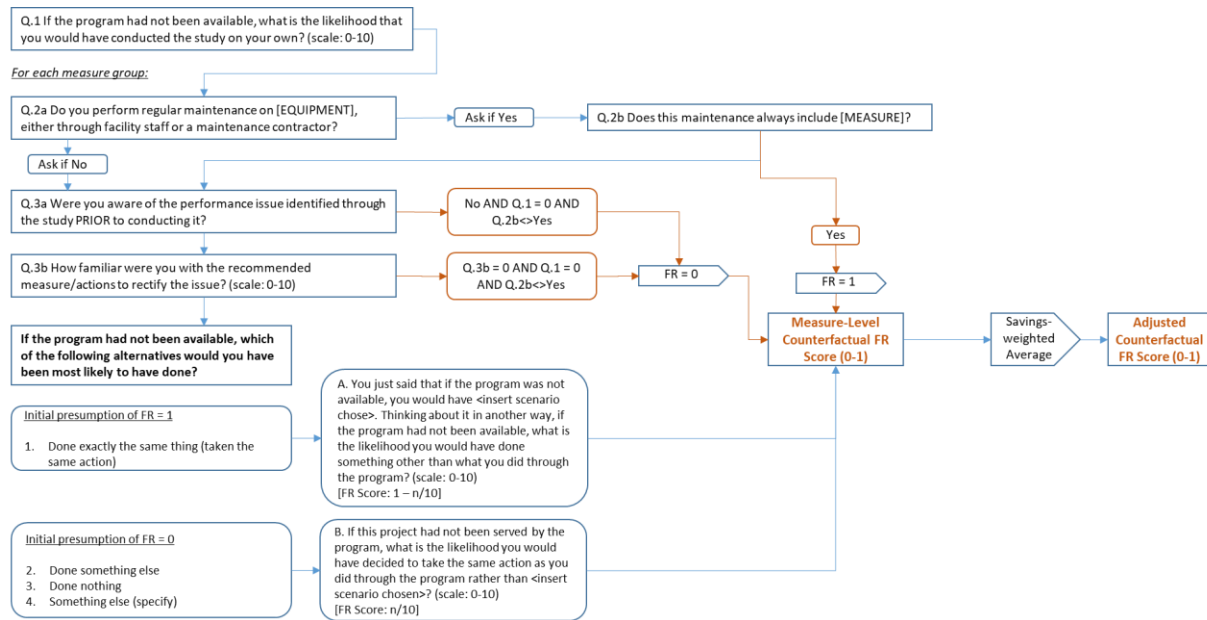

Figure 3-5. Study-Based Free Ridership—No-Program FR Score Option #2



Note that the orange arrows in this diagram indicate score assignments rather than survey skips.

Evaluators will calculate free ridership values for study-based programs as follows:

$$FR = \text{AVERAGE}([\text{Program Influence FR Score}], [\text{Counterfactual FR Score}]) * [\text{Quantity \& Timing Adjustment}]$$

Evaluators will develop estimates of free ridership based on the two Counterfactual FR Score options outlined above. Evaluators will select one of these for purposes of calculating the annual incremental energy savings for comparing to the legislated goal. Evaluators will present the results of both estimates of free ridership in EM&V reporting.

3.3 Technical Assistance Protocol

This protocol is applicable to programs that provide technical assistance to encourage the adoption of energy efficiency measures in non-residential facilities, but do not provide financial incentives.

Program-attributable savings from Technical Assistance programs are achieved when a program participant—as a result of the program’s influence via the training or technical assistance provided—undertakes energy efficiency improvements on their own, without any direct financial assistance from any other Illinois energy efficiency program.

An initial determination of program-attributable savings is made based on self-reported findings from surveys of program participants. At a minimum, surveys collecting data pertaining to participant measure implementation will obtain general information on the specific measures installed and information substantiating their attribution to the program. Research on the specific characteristics of the energy-efficient equipment installed and the baseline and operating conditions needed to estimate savings may be done in one of two ways: 1) a detailed battery of measure specific questions may be administered as part of the initial survey; or 2) a separate in-depth follow-up interview may be conducted by the engineer or analyst responsible for the energy savings calculation. These collected data may be augmented by detailed facility and measure characteristics if provided by program staff.

3.3.1 Free Ridership

- The FR algorithm for Technical Assistance programs is identical to the Core Non-Residential FR protocol, with the following exception:
 - Key program factors differ extensively from conventional programs and therefore, are described in some detail here. Examples of Technical Assistance program factors that may be included are:
 - Documentation in a program-provided technical report of the energy saving

opportunities from installing the measure.

- Verbal information or guidance provided by a program representative or energy auditor during a training course or an on-site visit.
- A follow-up communication from the utility regarding implementing the recommendations provided through the audit, training, or technical assistance.

Examples of items that would not be considered Technical Assistance program factors are:

- Information from trade shows, conferences, or other professional gatherings
- Recommendation from an equipment vendor that sold you the measure and/or installed it
- Previous experience with the measure
- A recommendation from a design or consulting engineer
- Standard practice in your business/industry
- Corporate policy or guidelines
- Payback on the investment

4 Residential and Low Income Sector Protocols

The table below lists Illinois residential programs and the NTG protocol applicable to each program.⁶⁸ If the design of a given program changes significantly, then it may mean that the NTG protocol listed for that program in this document is no longer appropriate. If that happens, the evaluator should follow the procedures outlined in Section 1.4: Diverging from the IL-NTG Methods.

Table 4-1. Residential and Low Income Programs

Program Administrator	Free Ridership Protocol	Program Name
Ameren Illinois	4.2 Appliance Recycling Protocol	Appliance Recycling Initiative
	4.3 Residential Upstream Lighting Protocol	Retail Products Initiative – Lighting Products
	4.4 Prescriptive Rebate (With No Audit) Protocol	Retail Products Initiative – Non-Lighting Products Retail Products Initiative - Efficient Choice Tool*
	4.5 Single-Family Home Energy Audit Protocol	Market Rate Single Family Initiative – Home Efficiency
	4.6 Multifamily Protocol	Market Rate Multifamily Initiative
	5.3 Consumption Data Analysis Protocol	Behavior Modification
	5.4 Midstream Protocol	Market Rate Single Family Initiative – Midstream HVAC Channel
	†	Retail Products Initiative – Income Qualified Products Income Qualified Initiative Public Housing Initiative Direct Distribution of Efficient Products Initiative
ComEd	4.3 Residential Upstream Lighting Protocol and 5.4 Midstream Protocol	Retail/Online (mid- and up-stream measures)
	4.4 Prescriptive Rebate (With No Audit) Protocol	Retail/Online (end-user rebated measures) Contractor/Midstream Rebates (end-user rebated measures) Appliance Rebates Heating and Cooling Rebates Weatherization Rebates Efficient Choice*
	4.5 Single-Family Home Energy Audit Protocol	Single-Family Upgrades (market rate component)
	4.6 Multifamily Protocol	Multifamily Upgrades (in-unit perspective, market rate component)
	4.7 Energy Saving Kits and Elementary Education Protocol	Product Distribution (market rate component)
	5.3 Consumption Data Analysis Protocol	Behavior – Res/IE
	5.4 Midstream Protocol	Contractor/Midstream Rebates (mid- and up-stream measures)
	Attachment C Market Transformation	Electric Homes New Construction
	†	Retail/Online (income eligible component) Product Distribution (income eligible component) Single-Family Upgrades (income eligible component) Multifamily Upgrades (income eligible

⁶⁸ The “Free Ridership Protocol Name” in the second column of the table refers to the numbered sections in this document, e.g., “4.6 Multifamily Protocol.”

Program Administrator	Free Ridership Protocol	Program Name
		component) New Construction – IE Third Party – IE
Nicor Gas	4.4 Prescriptive Rebate (With No Audit) Protocol	Home Energy Efficiency Rebates (Single Family)
	4.5 Single-Family Home Energy Audit Protocol	Home Energy Savings (Single Family Assessment/ Direct Install)
		Weatherization (Wx) Prescriptive (Air/Duct Sealing and Insulation)
	4.6 Multifamily Protocol	Multi-Family (Assessment/ Direct Install /Direct Distribution) Multi-Family Prescriptive Rebates Central Plant Optimization
	4.7 Energy Saving Kits and Elementary Education Protocol	Elementary Education Kits Energy Saving Kits Home Energy Savings/Assessment Leave-Behind Kit
	4.8 Residential New Construction Protocol	Residential New Construction
	†	Income Qualified/Eligible Programs
	5.3 Consumption Data Analysis Protocol	Behavioral Energy Savings, Advanced Thermostats, Air Sealing with Attic Insulation
	5.2 Code Compliance Protocol	Code Compliance
Peoples Gas/ North Shore Gas	4.4 Prescriptive Rebate (With No Audit) Protocol	Home Energy Rebates
	4.5 Single-Family Home Energy Audit Protocol	Home Energy Jumpstart
	4.6 Multifamily Protocol	MF Custom MF Partner Trade Ally MF Prescriptive Multifamily (Direct Install)
		4.7 Energy Saving Kits and Elementary Education Protocol
	†	Income Eligible/Qualified Programs
	5.3 Consumption Data Analysis Protocol	Home Energy Reports, Advanced Thermostats, Air Sealing with Attic Insulation
All	5.4 Midstream Protocol	(Midstream Programs)

* Until further discussion and research occurs, evaluator consensus is that using the Prescriptive Rebate (With No Audit) protocol is the most appropriate path to pursue for Efficient Choice. However, given the atypical, non-rebate-based nature of this program, further discussion and research is likely appropriate for this program in coming years.

† The evaluation teams should follow the Policy Manual regarding NTG for Income Eligible programs.

4.1 Residential Cross-Cutting Approaches

The approaches in this section can apply to more than one program type but do not supersede program-specific approaches presented in later sections.

4.1.1 Survey Design Issues

Free ridership questions should be asked near the beginning of a participant survey, before asking satisfaction

questions. This should prevent participants from confusing free ridership questions with the satisfaction questions, which could influence free ridership scores. In particular, evaluators have observed that some respondents have interpreted the No Program – Efficiency question to be a satisfaction question, synonymous with, “Do you like this item? Would you purchase this?” Evaluators may add an explanation that this question is not about respondents’ satisfaction with the item.

4.1.2 Participant Spillover

Effective program marketing and outreach generates program participation and increases general energy efficiency awareness among customers. Spillover can be calculated using participant survey questions, which ask participants about energy-savings actions they have taken on their own since participating in the program. Questions should be sufficiently specific to ensure energy savings associated with spillover can be reasonably well-quantified. These may include questions about measure types or measures installed, quantities, and efficiency levels. When program implementers provide recommendations to participants and can provide data on the types of recommendations made to specific participants, evaluations should attempt to determine whether participants took the recommended actions outside of the program at sites within the program administrator’s service territory; if so, savings from those recommended actions should be attributed to the program.

To reduce the respondent’s burden, the survey should first ask participants about the influence the program had on their taking additional energy-saving actions on their own. In particular, the evaluation team should ask two close-ended questions to determine program influence on spillover actions. The two required questions, preceded by an optional open-ended warm-up question, are:

- OPTIONAL: Did the program influence you in any way to make these additional improvements?
- 1. How important was your participation in the <PROGRAM ADMINISTRATOR’S> program on your making additional energy efficiency improvements on your own? [Scale from 0-10 where 0 is “not at all important” and 10 is “extremely important”]
- 2. If you had not participated in the <PROGRAM ADMINISTRATOR’S> program, how likely is it that you would still have implemented this measure, using a 0 to 10, scale where 0 means you definitely WOULD NOT have implemented this measure and 10 means you definitely WOULD have implemented this measure?

The response to the first required question cited above is “Measure Attribution Score 1,” and the response to the second required question cited above is “Measure Attribution Score 2.” The specific measures referenced in the question are considered to be attributable to the program if the “Spillover Score” is greater than 5.0:

$$\text{Spillover Score} = (\text{Measure Attribution Score 1} + (10 - \text{Measure Attribution Score 2}))/2 > 5.0$$

If these conditions are met, the evaluator determines that the specific measures referenced in the question are attributable to the program; otherwise, the evaluator determines that the specific measures referenced in the question are not attributable to the program. The attribution criterion represents a threshold approach, in which energy impacts associated with measures implemented by program participants outside the program are either 100% program-attributable or 0% program-attributable.

For each measure mentioned, customers will be asked how they know the measure is more efficient than other models. If the respondent can identify the measure as ENERGY STAR or name an efficiency level that the evaluator confirms as being above the minimum federal standard, or if they identify a technology that the evaluator can confirm is above the minimum federal standard, it will count towards Participant Spillover.

Finally, depending on the measure type cited by the customer, follow-up questions should ask customers to provide reasonable information to allow the evaluator to estimate the amount of savings using IL-TRM protocols, such as quantity of appliances or the location and amount of insulation.

To calculate the spillover energy and demand savings for these actions, the appropriate version of the IL-TRM should be used. To develop the spillover rate, the total energy and demand impacts from the sampled participants who installed additional measures due to participation in the program are summed, and this sum is divided by the total verified gross impacts from all participants who took the survey.:

$$\text{Participant Spillover Rate (PSO)} = \frac{\text{Sum of Energy or Demand from Additional Measures Installed}}{\text{Sample Verified Gross Energy or Demand Impacts}}$$

The equation used to adjust the Core NTGR based on participant spillover is as follows:

$$\text{NTGR} = (1 - \text{FR} + \text{PSO})$$

4.1.2.1 Data Collection

Respondents should be drawn from a random sample of current or up to one year of previous program participants. Regardless of the participation year, spillover should be measured within the last 12 months (from the survey date), but after previous participation; the tracking database should supply this information.

4.1.2.2 Data Analysis

The following four steps calculate spillover:

1. Calculate total spillover savings for each participant installing an efficient measure not rebated through the program where the Spillover Score is greater than 5.0:

$$\text{Measure Spillover} = \text{Measure Savings} * \text{Number of Units}$$

2. Total savings associated with each program participant to calculate overall participant spillover savings.

3. Spillover Percentage Estimate =
$$\frac{\sum \text{Sample Spillover kWh Savings}}{\text{Sample Evaluated Program kWh Savings}}$$

4.1.3 Nonparticipant Spillover Measured from Customers

The evaluation may perform research to measure nonparticipant spillover (NPSO). If so, care should be taken to ensure spillover is not double-counted with a trade-ally approach. The basic method uses a two-step process: (1) conduct a nonparticipant survey to identify potential spillover measures and (2) if needed, conduct a follow-up call or on-site visit by technical staff to confirm attribution and obtain information needed to estimate energy savings.

4.1.3.1 Basic Method

Sampling

As spillover may be rare in the nonparticipating population, determining spillover will likely require a large sample of customers who have not participated in any energy efficiency programs, including a behavioral program, within the past three years. Customers will be removed from the sample frame if their account numbers can be cross-referenced against a list of program participants from the previous three years. The survey should target household members responsible for paying utility bills. Survey respondents will be asked a screening question (whether they have participated in a program in the past three years) to confirm their household qualifies as a true nonparticipant.

Measure-Specific Questions

Depending on the spillover measure type reported by the customer, follow-up questions should be included to gather sufficient information to reasonably assess the saving amount by applying the IL-TRM, understanding that assumptions must be made if IL-TRM inputs cannot be easily supplied by the participant. Such assumptions should be conservative, or, if not conservative, reasons for deviating from the conservative application should be documented. Measures that cannot be reasonably quantified within available evaluation budgets should be excluded from spillover calculations.

For measures included in the IL-TRM, savings will be assessed using the IL-TRM algorithms. Baselines for measures not in the IL-TRM will be assessed based on appliance standards and building codes, if applicable, and, if not, through engineering judgements of existing or market conditions. Engineering assumptions and analysis by the evaluator will be applied for measures not included in the IL-TRM. Key assumptions should be documented in the report.

4.1.3.2 Attribution Approach

To receive credit for energy savings, the nonparticipant must fit the following criteria: (1) be familiar with the Program Administrators energy efficiency campaign (e.g., ActOnEnergy for Ameren); and (2) indicate that some

aspect of the Program Administrator’s energy efficiency programs motivated their purchases. Influence will be measured on a scale of 0 to 10, where 10 is extremely influential and 0 is not at all influential. Savings attribution requires a Spillover Score of greater than 5.0.

Survey respondents will be asked a series of questions following the logic shown in Figure 4-1. First, the customer will indicate whether they know about their Program Administrator’s energy efficiency programs and/or marketing messages. If customer is aware, the survey will ask if they or anyone in their household made an energy efficiency improvement within the last year, and if so, what improvements they made. Responses to these questions will generate a list of potential spillover measures (shown at point “[A]” in Figure 4-1). Customers will be asked how they know the measure is more efficient than other models. If the respondent can identify the measure as ENERGY STAR or name an efficiency level that the evaluator confirms as being above the minimum federal standard, or if they identify a technology that the evaluator can confirm is above the minimum federal standard, it will count towards NPSO. At this point in the NPSO process, the customer could be referred for a follow-up call with a technical interviewer.⁶⁹

To assess attribution for each spillover measure mentioned, the customer will be asked questions to be scored in two areas. Spillover may be program-attributable for those measures for which self-report data meet the following threshold condition:

$$\text{Spillover Score} = (\text{Attribution Score 1} + (10 - \text{Attribution Score 2}))/2 > 5.0$$

Attribution Score 1

The first score, “Attribution Score 1,” measures the influence level (on a scale of 0 to 10, where 10 is extremely influential and 0 is not at all influential) their Program Administrator had on the purchase of the measure.

Influence can derive from the following:

1. General information about energy efficiency provided by the Program Administrator (e.g. through a bill insert)
2. Information from a contractor or retailer related to the Program Administrator’s programs.
3. Word-of-mouth from people installing energy-efficient equipment and receiving a rebate from the Program Administrator.

Attribution Score 1 is the maximum score (or Yes response) assigned to any source of influence from the Program Administrator.

Attribution Score 2

The second score, “Attribution Score 2,” comes from the customer’s response to a single question to assess the counterfactual, asking about the likelihood (on a scale of 0 to 10, where 10 is extremely likely and 0 is not at all likely) that the customer would have installed the measure had they not been influenced by the program.

The Spillover Score is then the average of the Attribution Score 1 and (10 – Attribution Score 2). If that Spillover Score is greater than 5.0, 100% of the savings are attributed to the Program Administrator for that measure.

Finally, depending on the measure type cited by the customer, follow-up questions will gather information to enable an estimate of savings (shown in the figure as [B]), such as quantity of appliances or the location of insulation.

⁶⁹ Customers who installed efficient lighting (CFL/LED) will not be eligible for NPSO if those savings are already claimed by an upstream lighting program. A separate NPSO protocol is provided specifically for upstream lighting programs.

Figure 4-1. NPSO Question Logic

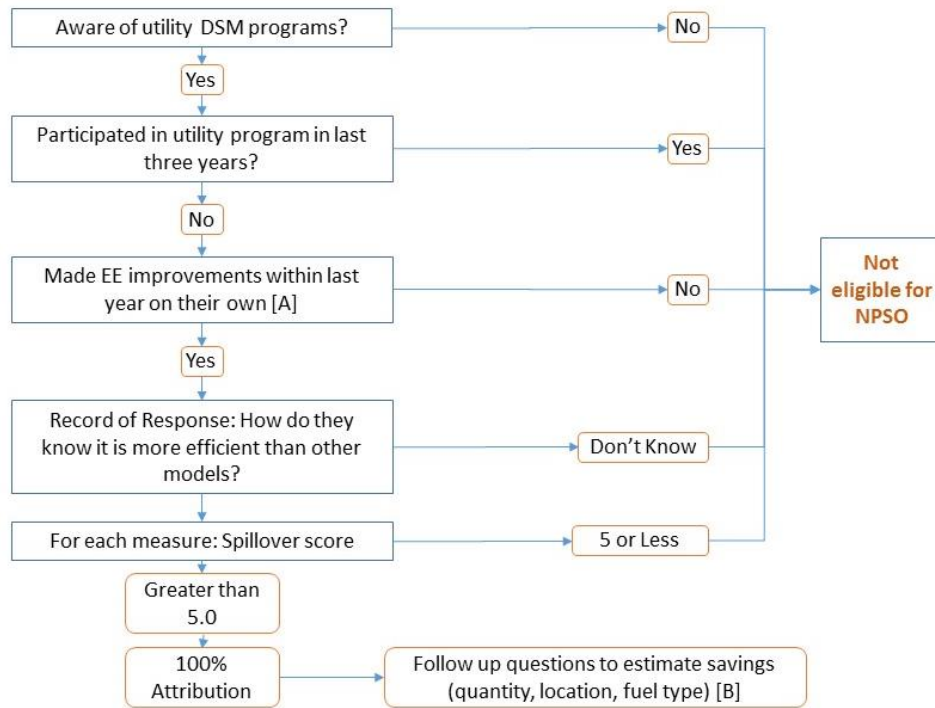

4.1.3.3 Scoring

Survey respondents’ answers to the NPSO questions will determine total energy and demand savings attributed to the program. Table 4-2 lists NPSO measures under column A, the Spillover Score under column B, the estimated measure savings under column C, the percentage of allocated savings under column D, and the total allocated savings under column E. Column F shows the calculated average energy savings per spillover measure, determined by dividing the total allocated savings (the sum of column E) by the number of surveyed nonparticipating customers. The table shows how kWh NPSO savings would be calculated; calculations of therm or demand savings would be accomplished in the same manner.

Table 4-2. Estimation of Respondents’ NPSO Savings

A	B	C	D	E	F
Spillover Measure	Spillover Score	Measure Savings (kWh)	Allocated Savings	Total kWh Savings	Average kWh Per Surveyed Customer
Measure1	Scale of 0 to 10	Savings1	100% if [B] > 5.0	[C] x [D]	N/A
Measure2	Scale of 0 to 10	Savings2		[C] x [D]	
MeasureN	Scale of 0 to 10	SavingsN	0% if [B] ≤ 5.0	[C] x [D]	
				Sum of column E = Total kWh Savings	Total kWh Savings ÷ Number of Completed Surveys

Table 4-3 shows the process for estimating total NPSO generated by the Program Administrator during the program year (for electric savings). The savings attributed from the survey population will be extrapolated to the nonparticipating residential customer population to determine the overall NPSO savings. Then NPSO energy savings will be converted into a percentage using the total evaluated electric savings for the program year. A similar process would apply for calculating therm or demand NPSO.

Table 4-3. Calculation of Total NPSO Generated

Variable	Description	Source/Calculation
F	Average kWh Energy Savings per Surveyed Customer	Survey data and Savings Calculation
J	Total Nonparticipating Residential Population	Customer database
K	NPSO MWh Energy Savings Extrapolated to Nonparticipating Population	$[F \times J] \div 1,000 \text{ kWh/MWh}$
S	Total Evaluated MWh Savings	Residential Portfolio Savings
G	NPSO Spillover Rate	$K \div S$

4.2 Appliance Recycling Protocol

Appliance recycling programs (ARPs) typically offer some mix of incentives and free pickups for the removal of old but operable refrigerators, freezers, or room air conditioners. These programs encourage consumers to undertake the following:

- Discontinue use of secondary or inefficient appliances;
- Relinquish appliances previously used as primary units upon their replacement (rather than keeping the old appliance as a secondary unit); and
- Prevent the continued use of old appliances in other households through direct transfers (i.e., giving it away or selling it) or indirect transfers (resale in the used appliance market).

As the program theory and logic for appliance recycling differ significantly from standard “downstream” incentive programs (which typically offer rebates for purchases of efficient products), the free ridership estimation approach also significantly differs.

The basic and enhanced methods are described next.

4.2.1 Basic Method

4.2.1.1 Free Ridership

Free ridership is based on participants’ anticipated plans had the program not been available, thus classifying a free rider as a participant who would have removed the unit from service regardless of the program.

Estimating net savings for ARPs should adopt a multistep process to segment participants into different groups, each with specific attributable savings.

In general, independent of program intervention, participating appliances would have been subject to one of the following options:

1. The appliance would have been kept by the participating household.
2. The appliance would have been discarded in a way that transfers the unit to another customer for continued use.
3. The appliance would have been discarded in a way that would have permanently removed the unit from service.

Only Option 3 constitutes free ridership (the proportion of units that would have been taken off the grid absent the program). Options 1 and 2 both indicate non-free riders. However, these respondents need to be further classified to account for secondary market impacts, described below.

Data Collection

A participant survey—drawn from a random sample of participants—will serve as the primary source of data collected for estimating NTG for the ARP. To determine the percentage of participants in each of the three options, evaluators will begin by asking surveyed participants about the likely fate of their recycled appliance had it not been decommissioned through the program. Responses provided by participants generally can be categorized as follows:

1. Kept the appliance.
2. Sold the appliance to a private party (either an acquaintance or through a posted advertisement).
3. Sold or gave the appliance to a used-appliance dealer.
4. Gave the appliance to a private party, such as a friend or neighbor.
5. Gave the appliance to a charity organization, such as Goodwill Industries or a church.
6. Had the appliance removed by the dealer from whom the new or replacement appliance was obtained.
7. Hauled the appliance to a landfill or recycling center.
8. Hired someone else to haul the appliance away for junking, dumping, or recycling.

Additional, follow-up questions will be included to validate the viability of all responses.

Next, evaluators will assess whether each participant’s final response indicates free ridership:

- Some final responses clearly indicate free ridership, such as: “I would have taken it to the landfill or recycling center myself.”
- Other responses clearly indicate no free ridership, as when the appliance would have remained active within the participating home (“I would have kept it and continued to use it”) or used elsewhere within the Program Administrator’s service territory (“I would have given it to a family member, neighbor, or friend to use”).

If the respondent planned to have the unit picked up by the retailer and the retailer would likely resell the unit in the secondary market, they are not a free rider. Absent retailer survey primary research described in the Enhanced Options below, the evaluators will utilize data from the most recent research conducted of the ComEd program to determine the proportion of free riders unless another metric is mutually agreed upon by the evaluators.⁷⁰

Secondary Market Impacts

In the event that the unit would have been transferred to another household (Option 2 above), the question then becomes what purchasing decisions are made by the would-be acquirers of participating units now that these units are unavailable. Such would-be acquirers could:

1. Not purchase/acquire another unit.
2. Purchase/acquire another used unit.

Adjustments to savings based on these factors are referred to as the program’s secondary market impacts.

If it is determined that the participant would have directly or indirectly (through a market actor) transferred the unit to another customer on the grid, the next question addresses what that potential acquirer did because that unit was unavailable. There are three possibilities:

- A. **None of the would-be acquirers would find another unit.** That is, program participation would result in a one-for-one reduction in the total number of appliances operating on the grid. In this case, the total energy consumption of avoided transfers (participating appliances that otherwise would have been used by another customer) should be credited as savings to the program. This position is consistent with the theory that participating appliances are essentially convenience goods for would-be acquirers. (That is, the potential acquirer would have accepted the appliance had it been readily available, but because the appliance was not a necessity, the potential acquirer would not seek out an alternate unit.)
- B. **All of the would-be acquirers would find another unit.** Thus, program participation has no effect on the total number of appliances operating on the grid. This position is consistent with the notion that participating appliances are necessities and that customers will always seek alternative units when participating appliances are unavailable.

⁷⁰ Note that such retailer interviews are being conducted annually for the ComEd ARP evaluation, and answers are used directly in the calculation of the NTG ratio in cases where: (1) the respondent planned to have the unit picked up by the retailer; and (2) the retailer was interviewed.

- C. **Some of the would-be acquirers would find another unit, while others would not.** This possibility reflects the awareness that some acquirers were in the market for an appliance and would acquire another unit, while others were not (and would only have taken the unit opportunistically).

The evaluators will assume Possibility C unless primary research within a Program Administrator's service territory to assess the secondary appliance market is undertaken as described in the Enhanced Options below. Specifically, evaluators will assume that half (0.5, the midpoint of Possibilities A and B) of the would-be acquirers of avoided transfers found an alternate unit.

Once the proportion of would-be acquirers who are assumed to find alternate units is determined, the next question is whether the alternate unit was likely to be another used appliance (similar to those recycled through the program) or, with fewer used appliances presumably available in the market due to program activity, would the customer acquire a new standard-efficiency unit instead.

4.2.1.2 Integrating Free Ridership and Secondary Market Impacts

The flow chart shown in Figure 4-2 illustrates how net savings will be derived for an ARP. As shown, below, expected savings fall into three different scenarios.

Figure 4-2. Appliance Retirement Scenarios

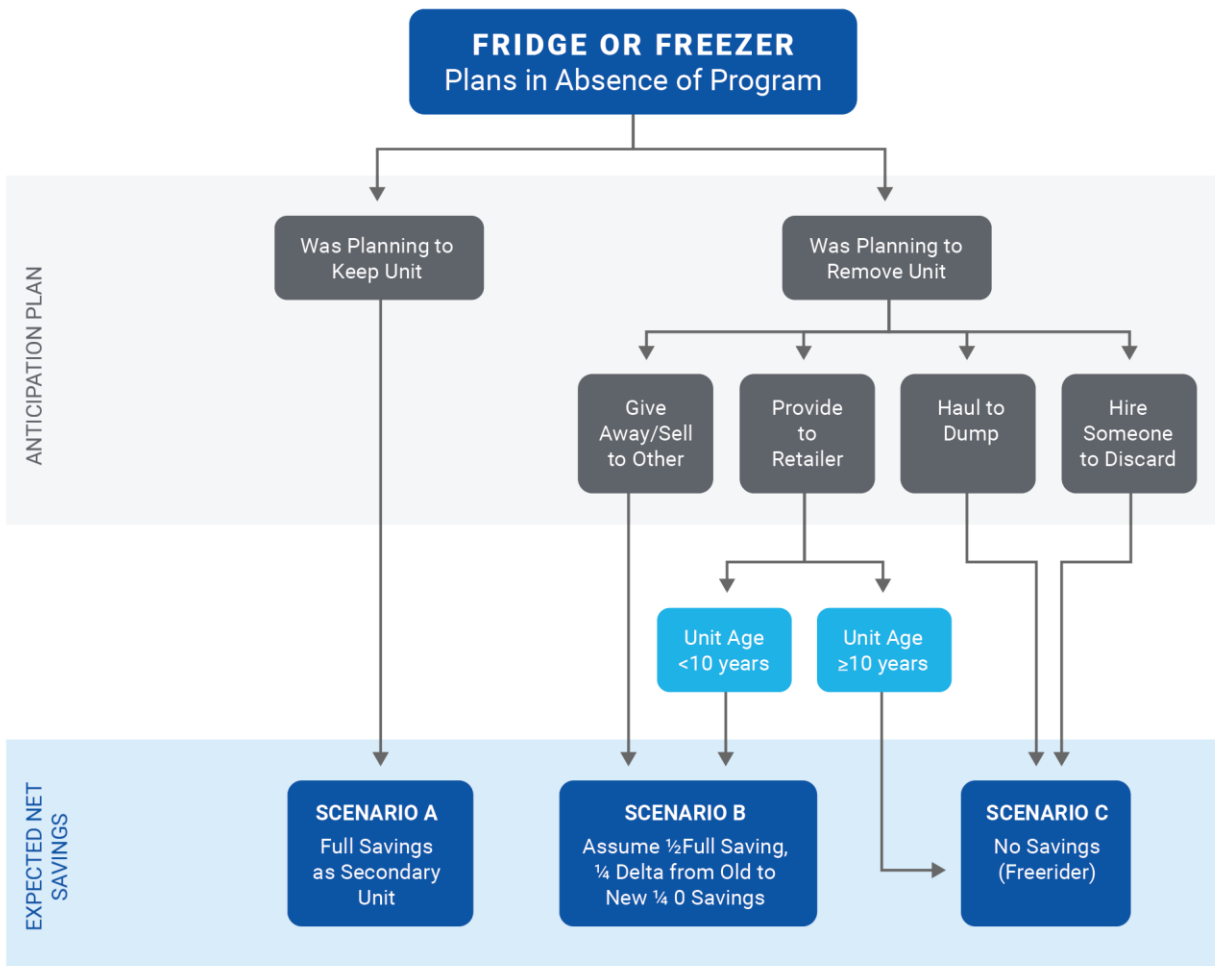

Source: Adapted from the Pennsylvania Statewide Evaluator Common Approach for Measuring Net Savings for Appliance Retirement Programs, Guidance Memo-026, March 14, 2014.

4.2.1.3 Scoring Algorithm

Net savings will be assigned individually to each respondent, based on responses provided to the questions discussed above. Net savings will be averaged across all respondents to calculate program-level net savings. The following equation will be used:

$$FR = (\text{free ridership and secondary market impacts \%} - \text{induced replacement \%})$$

Table 4-4 demonstrates the proportion of a sample population classified into each of the eight potential (Tertiary Classification) categories and the resulting weighted net savings.

Table 4-4. Net Savings Example for a Sample Population*

Primary Classification	Secondary Classification	Tertiary Classification	Population (%)	UEC (kWh) w/out Program	UEC (kWh) w/ Program	kWh Savings
Would have kept unit	Scenario A: Kept No Induced Replacement	N/A	25%	1,026	0	1,026
Would have	Scenario B:	N/A	30%	1,026	520	506

Primary Classification	Secondary Classification	Tertiary Classification	Population (%)	UEC (kWh) w/out Program	UEC (kWh) w/ Program	kWh Savings
removed unit	Transferred No Induced Replacement					
	Scenario C: Removed from Service	Recycled/ Destroyed	20%	0	0	0
		Retailer would Recycle	13%	0	0	0
Net Savings (kWh)						475

*The percent values presented in this table serve only as examples; actual research should be conducted to determine the percentage of units falling into each of these categories. Note that UEC (Unit Energy Consumption) values presented in the table represent example values, factoring in part-use.

4.2.2 Enhanced Method

Results can be enhanced by including three additional research efforts. The basic method has defaults where primary research on enhanced approaches cannot be performed:

1. A retailer survey, to determine the quantity and/or proportion of units returned to a retailer and that the retailer would deconstruct or recycle. Through this survey, one would determine a retailer’s criteria for reselling used units vs. deconstructing them, based on unit age and condition. Results from the survey and analysis would be used to determine the proportion of those who would have returned an old appliance to the retailer that should be included in Scenario D (free riders). This research was conducted for ComEd in EPY6 evaluation, and those results were applied to Ameren.
2. An appliance market assessment study to determine the size of the secondary appliance market and whether removal of participating units from the market would cause an otherwise would-be receiver to purchase an alternative used or new unit. Savings attributable to these participants are the most difficult to estimate, as the scenario attempts to estimate what the prospective buyer of a used appliance would do in the absence of finding a program-recycled unit in the marketplace (i.e., the program took the unit off the grid, so the prospective purchaser faced, in theory, a smaller supply of used appliances). It is difficult to answer this question with certainty, absent Program Administrator-specific information regarding the change in the total number of appliances (overall and used appliances specifically) that were active before and after program implementation. In some cases outside of Illinois, evaluators have conducted in-depth market research to estimate both the program’s impact on the secondary market and the appropriate attribution of savings for this scenario. Although these studies are imperfect, they can provide Program Administrator-specific information related to the program’s net energy impact. Where feasible, evaluators and utilities should design and implement such an approach. Unfortunately, this type of research tends to be cost-prohibitive, or the necessary data may simply be unavailable.
3. However, it is possible to estimate through nonparticipant surveys which of the disposal responses given by nonparticipants were most likely to have been to an opportunistic would-be-acquirer. Transfers that would most likely have been opportunistic are determined primarily based on the cost to the recipient. If the appliance was sold or transferred to a retailer, there would have been a cost to the recipient of that appliance. If the recipient was willing to pay for the appliance or was willing to exert the effort to visit a retail location, this suggests the recipient was actively seeking an appliance. However, if the unit were given away for free, there was little cost to the recipient, and it is a reasonable proxy for the proportion of opportunistic acquirers. This proportion would replace the 50% default assumption (scenario C in Figure 4-2) of would-be-acquirers that would or would not find an alternate unit.
4. A nonparticipant survey can be used to assess how nonparticipants acquire and dispose of used units. As nonparticipants do not have the same perceived response bias as participants, they can help offset some of this potential bias in estimating the true proportion of the population that would have recycled their units in program’s absence. The evaluators will average the results of the nonparticipant survey with the participant survey if the nonparticipant survey is of sufficient sample size. Otherwise, results may be used

for a qualitative characterization of potential bias. Though recommended, use of a nonparticipant survey need not be required, given budget and time considerations. A nonparticipant survey was completed as part of ComEd's EPY6 evaluation and used qualitatively to validate participant results.

4.3 Residential Upstream Lighting Protocol

The Illinois Residential Upstream Lighting programs to date have provided discounts on efficient lighting through retailers at the point of purchase. Such programs often remain transparent to customers purchasing incentivized lighting. Program administrators also do not know the identity of most customers purchasing the program-discounted lighting; so these customers cannot easily be contacted once they leave the store for a traditional self-report NTG evaluation survey (i.e., an after-the-fact, direct solicitation of customers regarding what they would have done in the program's absence). Similar surveys can be conducted with customers within program retailers after they have made their lighting purchasing decision but before they leave the store. For programs such as this, in store customer surveys are preferable to the traditional self-report telephone surveys that ask customers to recall their past light bulb purchases. Light bulbs are a small and relatively insignificant purchase for most people, thus the recall bias could be substantial.

Further, as upstream programs work with multiple market actors and can include wide-reaching marketing campaigns promoting energy efficiency to the general public, they tend to stimulate spillover and "market effects." As a result, estimating NTG for upstream residential lighting programs can be challenging. Multiple methods exist, each with their own strengths and weaknesses.

Ameren and ComEd implement their residential lighting programs comparably, and the evaluation teams have used a consistent primary NTG evaluation method. This section details the consensus NTG methodology, which has been used multiple times for both ComEd and Ameren and is considered the most well-vetted and defensible NTG method that has been successfully used in Illinois.

For EPY5 and EPY6, Ameren and ComEd used a customer self-report methodology to estimate NTG for their upstream residential lighting programs.⁷¹ Customer self-report data in this method are collected during surveys conducted within program retailers with customers purchasing program bulbs (i.e., in-store intercept surveys). This method separately estimates free ridership, participant spillover, and nonparticipant spillover. Details follow on the primary data collection and scoring algorithms.

4.3.1 Basic Method

4.3.1.1 Free Ridership

Free ridership for this program is calculated as the proportion of program bulbs that would have been purchased if the program did not exist. Three alternative scenarios could occur:

1. Full Free Rider: The customer would have purchased the same quantity of efficient bulbs (CFLs or LEDs) in the program's absence.
2. Partial Free Rider: The customer would have purchased fewer efficient bulbs (CFLs or LEDs) in the program's absence.
3. Non-Free Rider: The customer would have not purchased any efficient bulbs (CFLs or LEDs) in the program's absence.

Free ridership is calculated as the average of two distinct scores: a Program Influence Score and a No-Program score. These scores are defined as follows:

1. The Program Influence Score captures the maximum level of program influence, reported by a survey respondent, of the residential lighting program on their decisions to purchase program bulbs on the day of the survey. This program influence can take a number of forms, such as: the monetary incentive provided to decrease the cost of high-efficiency bulbs; program-sponsored educational materials that explain the

⁷¹ ComEd has used this method since EPY2. Ameren began using it in EPY5.

benefits of efficient lighting; in-store product placement of efficient bulbs; and program bulb recommendations provided by retail store personnel.

2. The No-Program Score is used to estimate how many program bulbs a survey respondent would have purchased in the absence of the residential lighting program.

Figure 4-3 illustrates the scoring algorithm for Residential Upstream Lighting Free Ridership via In-Store Intercepts.

Figure 4-3. Residential Upstream Lighting Free Ridership via In-Store Intercept

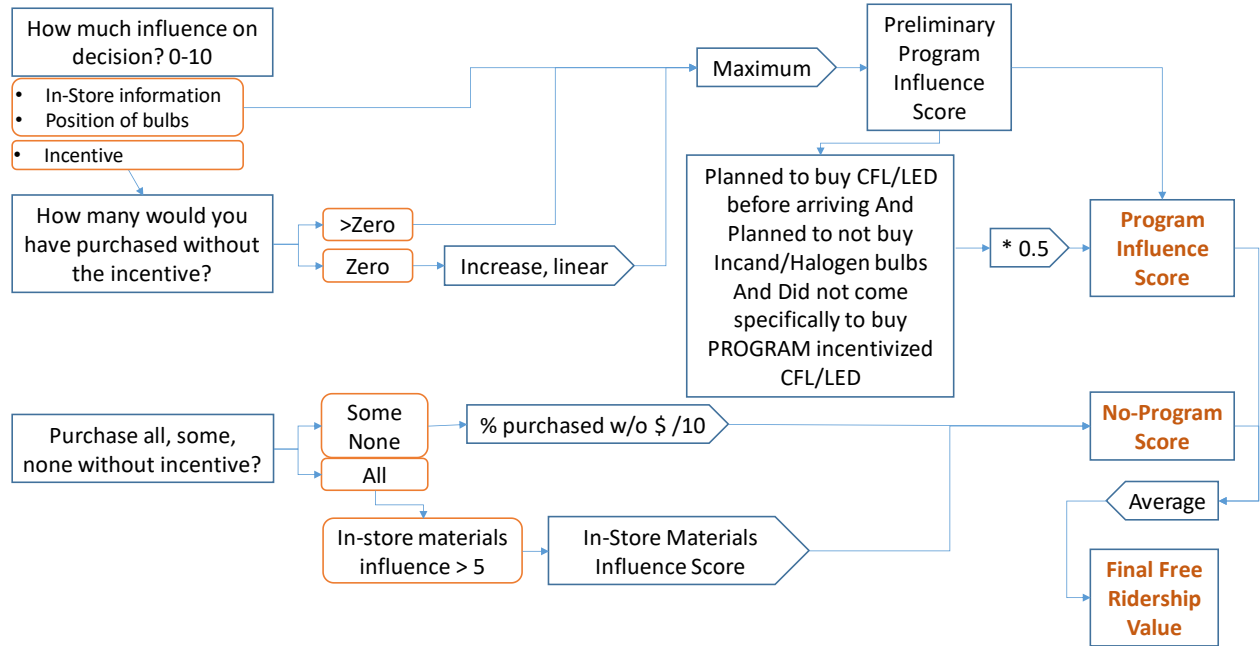

4.3.1.2 Data Collection

To estimate free ridership, the evaluation teams will conduct in-store intercept surveys with customers purchasing program-discounted lighting at participating retailers. Customers are asked questions that are used to estimate a Program Influence Score and a No-Program Score for each customer and efficient bulb type purchased.

Primary Program Influence Score Questions

1. Light bulb purchasing plans for current shopping trip (Yes/No)
2. If planning to purchase bulbs:
 - a. Bulb type (CFL, LED, Incandescent, Halogen)
 - b. Program administrator-incentivized bulbs (Yes/No)
3. Influence of various program factors:
 - a. Program incentive
 - b. In-store information (printed materials or information from Program Administrator representatives or retail personnel)
 - c. Positioning of discounted bulbs within the store

Primary No-Program Score Questions

1. Stated preference of light bulb purchases had the Program Administrator incentive not been available (purchase all, some, or none of efficient bulbs)
2. Quantity of light bulbs purchased absent the incentive

4.3.1.3 **Scoring Algorithms**

Using the data collected from program participants during the in-store intercept surveys, Program Influence and No-Program Scores are calculated for each survey respondent and then combined to estimate a respondent-specific Free Ridership Score.

Calculation of the Program Influence Score

Survey respondents purchasing one or more program-discounted bulbs are assigned a Preliminary Program Influence Score based on the maximum program influence level (on a 0 to 10 scale) they assigned to one or more program factors (e.g., monetary incentive/informational materials [printed or from store personnel]/product positioning). The influence level assigned to the monetary incentive should be increased for survey respondents (using a linear decreasing function)⁷² who indicated that, absent the incentive, they would not have purchased any of the program bulbs they were purchasing that day.

After the Preliminary Program Influence Score is assigned, a secondary algorithm is run that adjusts the preliminary program influence based on survey data regarding the customers purchasing plans when they entered the store. Survey respondents who indicated they planned to purchase high-efficiency bulbs prior to entering the store and who had not come to the store specifically to buy Program Administrator-incentivized program bulbs, should have their Program Influence Score cut in half. This adjustment makes the final Program Influence Score reflective of their stated planned intention to purchase efficient bulbs in the program’s absence.

Calculation of the No-Program Score

The No-Program Score is based on whether a respondent states they would have purchased all, some, or none of the program-discounted bulbs in the absence of Program Administrator incentives. Respondents reporting they would have purchased all of the efficient bulbs without the incentive should be considered free riders and receive a No-Program Score of zero. Those reporting they would have purchased none of the efficient bulbs without the incentives should be classified as non-free riders and receive a No-Program Score of 10, the maximum. Respondents reporting they would have purchased some of the efficient bulbs without the incentive should be assigned a No-Program Score between 0 and 10, reflective of the percentage of efficient bulbs they would not have purchased absent the program.

Respondents reporting they would have purchased all of the program-discounted bulbs in the program’s absence, but in-store materials provided by the Program Administrator had a moderate to high influence on their decision, should have their No-Program Scores adjusted to equal the level of influence they attributed to these program-sponsored informational materials.

4.3.1.4 **Calculation of Free Ridership**

The Free Ridership rate is calculated as follows:

$$\text{Free Ridership} = 1 - (\text{Program Influence Score} + \text{No-Program Score})/20$$

Using the calculated Program Influence and No-Program Scores, Free Ridership is calculated as one minus the sum of the two scores (Program Influence Score plus No-Program score), divided by 20. Dividing the sum of scores by 20 results in a ratio (between 0 and 1) that is representative of the average of the two zero to 10 scores. Subtracting this ratio from one reverses the score, thus representing the free ridership level. If either the No-Program or Program Influence Scores are missing, Free Ridership can be calculated using the single available score divided by 10. Evaluators may also reference available data to perform documented modifications to individual free ridership estimates resulting from the application of this free ridership assessment methodology.

⁷² The function, adjusted monetary score = (monetary score + 10)/2, increases the monetary score using a decreasing linear function. This function results in an increase in the monetary influence score of between 0 and 5 points depending on their original monetary score (i.e., an original score of 0 would become a 5, a 5 would become a 7.5, and a 10 would remain a 10). In past Illinois evaluations, this adjustment has typically changed less than 10% of all monetary scores.

4.3.2 Participant Spillover

For this program, participant spillover results from purchases of non-discounted efficient bulbs by program bulb purchasers who are influenced by their participation in the residential lighting program to purchase additional non-discounted efficient bulbs.

4.3.2.1 Data Collection

Data collected during in-store intercept surveys with customers purchasing program bulbs should be used to estimate participant spillover. During these surveys, customers purchasing program-discounted and non-discounted efficient bulbs (CFLs or LEDs) should be asked questions to determine whether the residential lighting program influenced their purchases of non-discounted efficient bulbs.

Primary Program Influence Score Question

1. Influence of the lighting program or in-store information on the customer’s decision to purchase non-discounted CFLs or LEDs. (0 to 10 scale where 0 is not at all influential and 10 is extremely influential)

4.3.2.2 Scoring Algorithm

To estimate participant spillover, the number of program-influenced, non-discounted efficient bulbs (CFLs or LEDs) purchased by program participants is divided by the total number of program bulbs purchased by these program participants. This results in the Participant Spillover Rate.

Step 1: Estimate the total number of non-discounted energy efficient bulbs purchased by respondents that had also purchased program-discounted bulbs and were influenced by the program. Respondents who gave a rating of greater than 5 on the program influence question are considered to be influenced by the program.

Figure 4-4 below provides a visual depiction of the process of qualifying non-discounted bulbs as participant spillover bulbs.

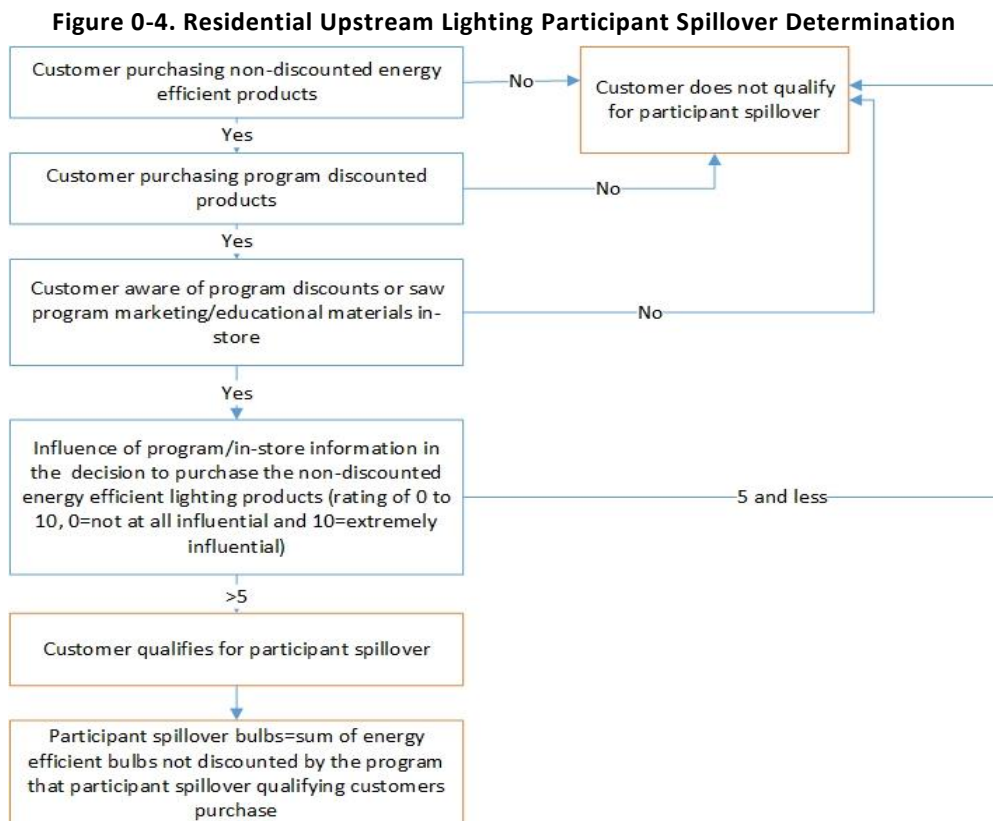

Step 2: Calculate the total number of program-discounted bulbs purchased by summing the number discounted bulbs purchased by all respondents.

Program Bulb Purchases = sum(Number of Discounted CFLs or LEDs purchased)

Step 3: Calculate the spillover rate by dividing the total number of spillover bulbs purchased by the total number of program-discounted bulbs purchased.

Spillover Rate = Spillover Purchases/Program Purchases

4.3.3 Nonparticipant Spillover

Nonparticipant spillover results from purchases of non-discounted efficient bulbs by customers who are not purchasing program-discounted bulbs, but report that the residential lighting program influenced their decision to purchase non-discounted efficient bulbs.

4.3.3.1 Data Collection

Data collected during in-store intercept surveys with customers purchasing efficient bulbs not discounted by the program should be used to estimate nonparticipant spillover. During these surveys, customers purchasing non-discounted efficient bulbs (CFLs or LEDs) and not purchasing any program-discounted bulbs should be asked questions about awareness of the program discounts and point-of-purchase program marketing and educational materials. These questions are used to determine whether the residential lighting program influenced their purchases of non-discounted efficient bulbs.

Primary Program Influence Score Question

1. Influence of the lighting program or in-store information on the customer’s decision to purchase non-discounted CFLs or LEDs. (0 to 10 scale where 0 is not at all influential and 10 is extremely influential)

4.3.3.2 Scoring Algorithm

The nonparticipant spillover scoring algorithm involves estimating the total number of nonparticipants, the incidence of nonparticipants in the sample, the total number of nonparticipant spillover bulbs, and the average number of nonparticipant spillover bulbs per customer in the sample, and then extrapolating the sample estimates to the population of the utility customers. Below are the steps used to calculate the nonparticipant spillover rate.

Step 1. Determine nonparticipant spillover in the sample by following the steps outlined below.

- A. Determine the total number of nonparticipating customers in the survey sample:
Nonparticipating customers (survey) = customers who did not purchase any program-discounted energy efficient lighting products. These customers may have purchased non-discounted energy efficient lighting products, less efficient lighting products or both.
- B. Determine the incidence of nonparticipating customers in the survey sample by dividing nonparticipating customers by total customers in the sample:
Incidence of nonparticipating customers (survey)=Nonparticipating customers (survey)/total customers (survey)
- C. Determine total number of nonparticipant spillover bulbs by summing CFLs and LEDs not discounted by the program that were purchased by nonparticipating customers who were aware of the program discounts or marketing promoting energy efficient lighting and were influenced by it. Spillover qualifying bulbs are those purchased by customers who rate the program’s influence as greater than 5. The graphic below provides a visual depiction of the process of qualifying non-discounted products as spillover products.

Figure 4-5 below provides a visual depiction of the process of qualifying non-discounted bulbs as nonparticipant spillover bulbs.

Figure 0-5. Residential Upstream Lighting Nonparticipant Spillover Determination

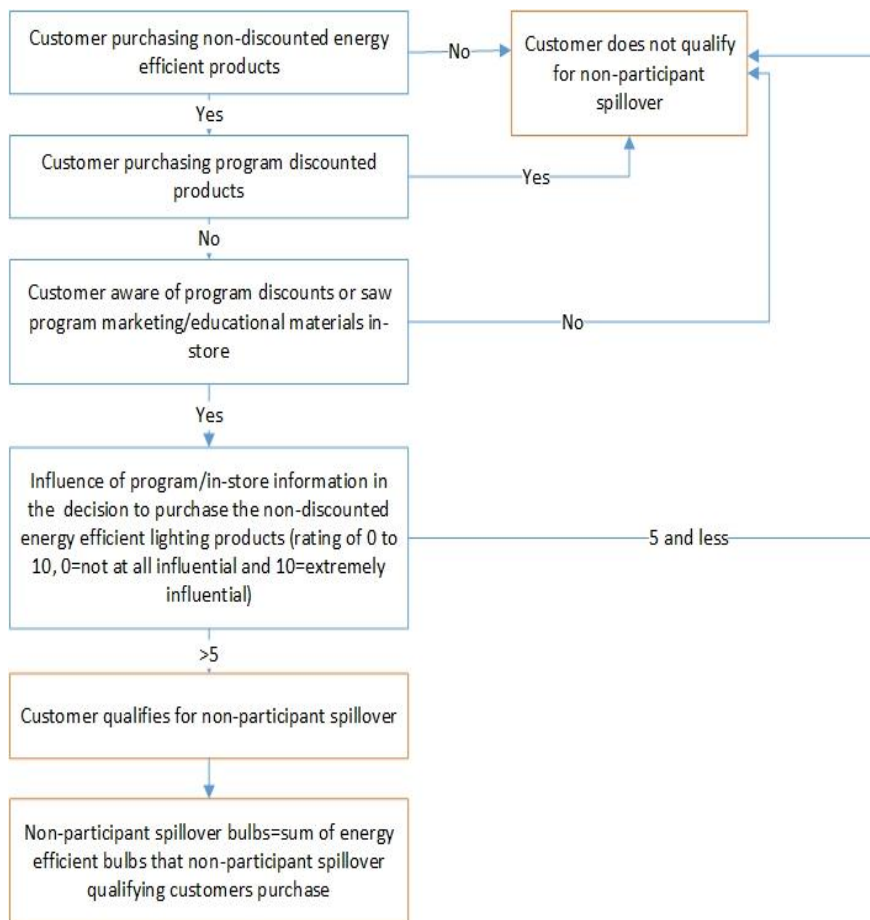

- D. Determine the average number of non-participating spillover bulbs per non-participating customer by dividing the total number of non-participating spillover bulbs in the survey by the total number of non-participating customers in the survey.

$$\text{Average number of nonparticipating spillover bulbs (survey)} = \frac{\text{total number of nonparticipating spillover bulbs (survey)}}{\text{nonparticipating customers (survey)}}$$

Step 2. Extrapolate nonparticipant spillover to the population

- A. Determine the total number of nonparticipating customers in the population by applying the nonparticipant incidence rate from the sample to the population

$$\text{Total number of nonparticipating customers (population)} = \text{Utility residential customer count} * \text{incidence of nonparticipating customers (survey)}$$

- B. Determine the total number of spillover bulbs by multiplying the average number of spillover bulbs per nonparticipating customer in the survey by the total estimate of nonparticipating customers

$$\text{Total number of nonparticipating spillover bulbs} = \text{Average number of nonparticipating spillover bulbs (survey)} * \text{total number of nonparticipating customers (population)}$$

Step 3. Calculate nonparticipant spillover rate by dividing the total number of nonparticipant spillover bulbs in the population by the total number of program-discounted bulbs:

$$\text{Nonparticipant spillover rate} = \frac{\text{total number of nonparticipating spillover bulbs}}{\text{total number of program discounted bulbs}}$$

4.3.3.3 Method Advantages and Disadvantages

The in-store intercept method described above has certain advantages and disadvantages.

Advantages: This approach catches customers at their point of purchase, before they leave the store and can no longer be contacted directly. Given the interview’s timing, customers can more easily recall price factors leading to their purchase choices. Also, as customers are intercepted at the store rather than surveyed by telephone, a higher cooperation rate results.

Disadvantages: Customers may not fully connect the impact that in-store education, product placement, and advertising have on their decision making. While many consumers believe they are not influenced by advertising, retailers know advertising and product placement work. Further, store intercepts typically must be coordinated with education events, and many retailers do not allow interviews to take place in their stores. Consequently, results are not based on random samples of customers purchasing program-discounted lighting throughout the year and across all participating retailers, which could bias the results.

4.4 Prescriptive Rebate (With No Audit) Protocol

Prescriptive Rebate programs typically offer predetermined rebates to residential customers for purchasing measures such as high-efficiency furnaces, clothes washers, brushless/electronically commutated motors (ECMs), boilers, boiler reset controls, water heaters, air-source heat pumps (ASHPs), ground-source heat pumps (GSHPs), central air conditioners (CACs), programmable thermostats, smart thermostats, insulation, air sealing, duct sealing, and desktop power management software. The program may require installation by a registered program ally, but it does not require a home audit (although purchases may be made in response to an audit).

These programs encourage consumers to undertake the following:

- Purchase higher-efficiency equipment than they otherwise would have, had they shopped for such equipment at the same time (replace on burnout); and
- Replace operating but inefficient equipment with higher-efficiency equipment (early replacement).

The basic method for estimating free ridership and participant spillover (See Section 4.1.2) for these programs uses a participant self-report, based on a standard battery of questions. An enhanced method may utilize trade ally surveys to provide another quantitative assessment, which may be triangulated with the basic method approach. As discussed further in Section 5.2, trade ally surveys may also be used to assess nonparticipant spillover.

4.4.1 Basic Method

4.4.1.1 Free Ridership

The free ridership assessment battery is brief to avoid applying an undue survey burden, yet it seeks to reduce self-report biases by including two main free ridership components:

- A Program Influence component, based on the participant’s perception of the program’s influence on carrying out the energy-efficient project; and
- A No-Program component, based on the participant’s intention to carry out the energy-efficient project without program funds.

When scored, each component assesses the likelihood of free ridership on a scale of 0 to 10, with the two scores averaged and for a combined total free ridership score. As different and opposing biases potentially affect the two main components, the No-Program component typically indicates higher free ridership than the Program Influence component. Therefore, combining these decreases the biases.

Figure 4-6 illustrates the scoring algorithm.

Figure 4-6. Residential Prescriptive Rebate (With No Audit) Free Ridership

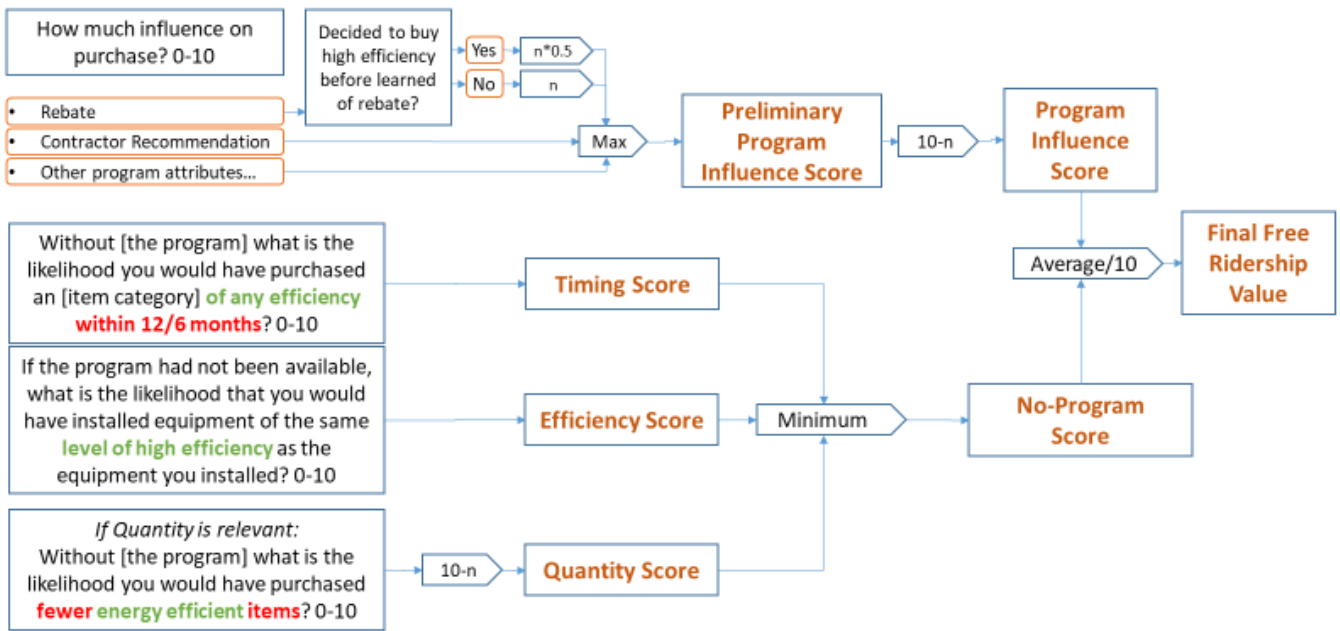

Calculation of the Program Influence Score

Program influence is assessed by asking respondents, on a scale from 0 (not at all important) to 10 (extremely important), how important they found various program elements were on their undertaking the project the way they did. The number of elements included will vary, depending on the program’s design. Logic models, program theory, and staff interviews typically inform the list of elements. Programs typically use the following elements to influence customer behavior: information; incentives or rebates; interaction with program staff (i.e., technical assistance); interaction with program proxies, such as members of a trade ally network; building audits or assessments; and financing.

In addition to asking about specific program influences, surveys ask respondents whether they planned to purchase a high-efficiency version of the product before learning of the rebate program. The respondent’s rating of the rebate’s influence is adjusted by 0.5 for those answering the question “yes.”⁷³ Evaluators should conduct a sensitivity analysis around the use of this adjustment and present it in the report.

The Preliminary Program Influence Score equals the maximum influence rating for any program element rather than, for example, the mean influence rating. This is based on the rationale that if any given program element had a great influence on the respondent’s action, then the program itself had a great influence, even if other elements had less influence.

An inverse relationship occurs between high program influence and free ridership: the greater the program influence, the lower the free ridership. The Program Influence (PI) Score = 10 - Preliminary Program Influence Score.

Calculation of the No-Program Score

The No-Program (NP) Score is based on three measures of the likelihood of a participant purchasing equipment of the same level of high efficiency as the unit installed with the program at the same time in the absence of the

⁷³ The Illinois NTG Working Group discussed using this question to check for consistencies rather than adjusting the score. The NTG working group agreed that it is preferable not to directly ask about conflicting language with residential customers and to utilize an open ended question instead to assess possible reasons for conflicting statements. It is the experience of the NTG working group members that residential customers tend to be more impatient with these types of questions and can typically respond easier to an open-ended question about their motivations.

program. Each of these likelihood measures are assessed on a 0-10 scale in which 0 means not at all likely and 10 means extremely likely.

First, the participant should be asked their likelihood of purchasing an item of *any efficiency* within 12 or 6 months (12 months for a single or big ticket item and 6 months for less expensive items) for the Timing (T) Score. Participants who were influenced by the program to replace still-functioning equipment will likely give a low score to this question, while participants who needed to replace burned out equipment will give a high score. This measure enables the analysis to use a single algorithm for both early replacement and replace-on-burnout scenarios.

Next, the participant should be asked a key question that asks the respondent to gauge their likelihood of purchasing, absent the program, equipment of the same level of high efficiency as the unit installed with the program. This measure forms the Efficiency Score. A respondent stating the likelihood of purchasing an item of the *same level of high efficiency* as a 5 on a scale of 0 to 10 is assigned an Efficiency Score of 5.

If multiple quantities of an item are purchased, the respondent should be asked about the likelihood of purchasing fewer energy-efficient items. The response to this question is subtracted from 10 to compute the Quantity (Q) Score.

The No-Program Score is the minimum of the Timing, Efficiency, and (if applicable) Quantity Scores. Finally, the No-Program Score is averaged with the Program Influence Score to calculate the Final Free Ridership Value.

$$\text{No Program Score (NP)} = \text{Min}(T, E, Q)$$

$$\text{Free Ridership (FR)} = \text{Mean}(PI, NP)$$

Consistency Checks

To address the possibility of conflicting responses (i.e., low intention score and high influence score), the survey should include consistency checks that, at a minimum, ask participants an open-ended question to address the program’s influence. For example:

- In your own words, please tell me the influence the program had on your purchase of the <insert measure name>.

In this case, the evaluation analyst will assess the response to this open ended question and its consistency with the other questions, and, if warranted based on clear additional information, they will adjust the score based on expert judgement. If an inconsistency exists and the open-ended response does not resolve the inconsistency, the respondent will be removed from the calculation. All instances of this occurring should be documented in the final report. Additional consistency checks, triggered and resolved within the survey with additional questions to participants, remain optional.

Missing responses to specific questions should be treated as “missing” for that particular question, but the observation or case will be retained in the analysis. Evaluation reports should note if this affects more than 5% of the responses.

4.5 Single-Family Home Energy Audit Protocol

Single-Family Home Energy Audit programs (or energy assessment programs) seek to secure energy savings for residential customers by providing audits, direct-install measures, and incentives for additional energy efficiency opportunities. The participation process generally begins with an energy audit, performed by a program-affiliated companies or individuals; this involves an auditor assessing the customer’s home to identify energy-saving opportunities. At that time, the auditor may install free instant-savings measures, such as CFLs, low-flow showerheads, and faucet aerators. Auditors also may educate customers about incentives available through the audit program (e.g., air sealing, insulation) or other Program Administrator-sponsored energy efficiency programs.

For these programs, free ridership and participant spillover (See Section 4.1.2) estimates rely on participant self-reports, gathered through surveys.

4.5.1 Basic Method

Given the multiple components of some audit programs, net impacts should be estimated using survey batteries

tailored to a customer’s experience (e.g., receipt of free direct-install measures and discounted or rebated measures). The following sections outline the approach for two program components, one dealing with the direct installation of free low-cost measures and a second dealing with envelope measures, such as air sealing and insulation.

4.5.1.1 No-Cost, Direct Install Measures

For free measures directly installed by program staff due to the audit, free ridership calculations should include the following components: Timing, Efficiency, and Quantity.

This approach provides several important benefits, such as deriving a partial free ridership score based on the likelihood that the participant would take similar actions in the absence of the audit. For example, partial scores can be assigned to customers who planned to install the measure, but the program influenced that installation, particularly in terms of timing (e.g., the program might have accelerated the installation) or quantity (e.g., the program might have led to installation of additional program-qualified measures).

Outlines of components and their associated survey questions follow:

- **Timing (T).** The first question to compute the Timing (T) Score accounts for earlier installation of measures due to the program by asking respondents about their likelihood (0-10 scale) to have installed an item of *any efficiency* within 6 or 12 months, had they not received it through the program (12 months for a single or big ticket item and 6 months for less expensive items).
- **Efficiency (E).** This score reflects the likelihood that customers would have installed equipment, absent the program, of the same level of high efficiency as the unit installed with the program. For free measures, this is based on a question asking respondents to rate the likelihood that they would have installed equipment of the same level of high efficiency as the unit installed had they not received them for free through the audit (on a 0 to 10 scale, where 0 is not at all likely and 10 is extremely likely). A higher likelihood value means a higher level of free ridership (i.e., a lower attribution level for the program).
- **Quantity (Q).** The question to compute the Quantity (Q) Score asks respondents about the likelihood that they would have installed fewer measures or performed less weatherization without the program. The response to this question is subtracted from 10 to compute the Quantity Score, as a lower score means a greater likelihood the respondent would have installed the same or a greater number of measures.

Given the low cost of the measures provided through the direct-install component of most audit programs and the number of measures received per participant, efforts have been made to streamline the free ridership battery to reduce the respondent’s burden. As such, the overall Final Free Ridership Value per measure can be calculated by taking the minimum of the Timing, Efficiency, and Quantity Scores, as shown in the following equation:

$$Free\ Ridership\ (FR) = Min(T, E, Q)$$

Figure 4-7 illustrates the algorithm for no-cost measures.

Figure 4-7. Single-Family Home Energy Audit Free Ridership—No Cost Measures

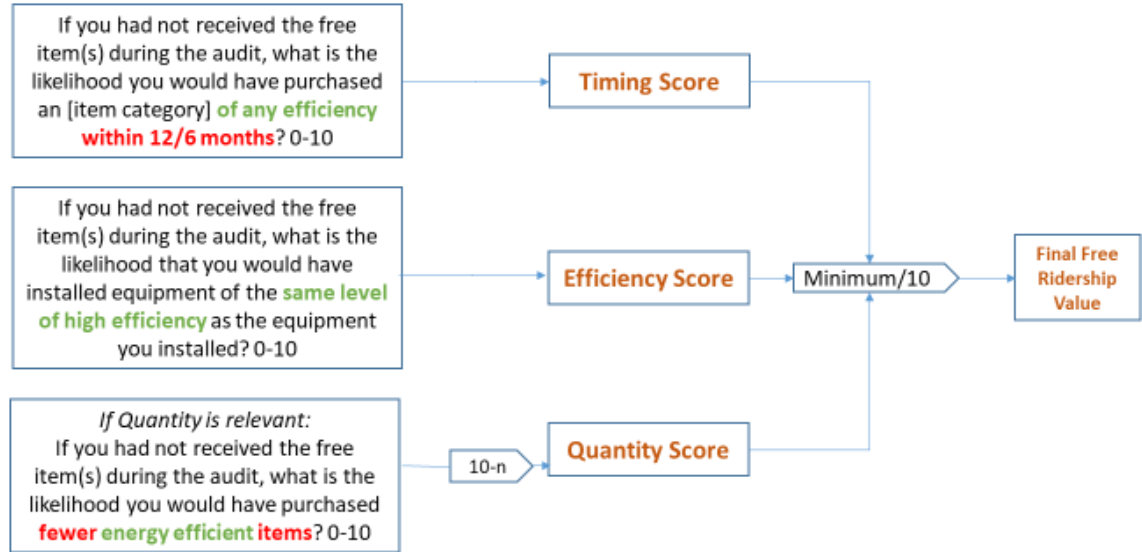

4.5.1.2 Rebated/Discounted Measures

Estimating NTG for rebated measures (typically for building shells) requires a more rigorous process than estimating NTG for free direct-install measures. In particular, the approach integrates an assessment of various program components that may have influenced the participant’s installation of the measures. For discounted envelope measures, the basic free ridership factor consists of the following two components:

- A Program Influence component, based on the participant’s perception of the influence of various program elements—including the discount and the audit itself—on carrying out the energy-efficient project; and
- A No-Program component, based on the participant’s likelihood of purchasing equipment, absent the program, of the same level of high efficiency as the unit installed at installed at the same time.

The free ridership method for discounted measures is identical to that used in the Prescriptive Rebate (With No Audit) protocol, with the one exception that the questions about program influence should be sure to include the audit itself as one of the program attributes. Evaluators should refer to Section 4.4.1.1 for details of the method. Figure 4-8 illustrates the algorithm for discounted measures.

Figure 4-8. Single-Family Home Energy Audit Free Ridership—Discounted Measures

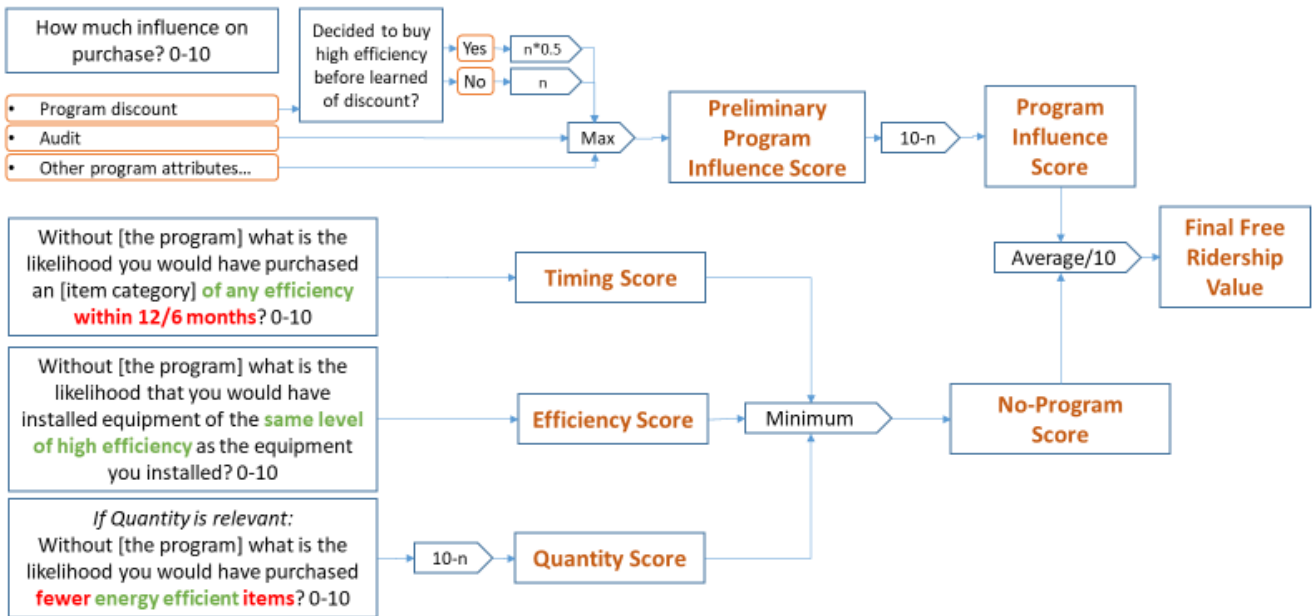

4.5.1.3 Consistency Checks

To address the possibility of conflicting responses (e.g., the high likelihood to install the same measure in the program’s absence and the high importance of program factors), the survey should include consistency checks that, at a minimum, ask participants an open-ended question to address a program’s influence, such as the following:

- In your own words, please tell me the influence the program had on your purchase of the <insert measure name>.

For low or no-cost, direct-install measures, surveys should include two questions to assess a program’s influence on the respondent. The first should be asked at the beginning of the NTG battery, and the second should be asked at its conclusion. Questions include the following:

- Prior to the audit, had you purchased any <measures>? Y/N
- IF YES AND LIKELIHOOD TO INSTALL WITHOUT THE PROGRAM IS <7: Given that you had purchased <measures> before receiving the audit, why didn’t you purchase additional <measures> on your own without the program? [OPEN END]
- IF NO AND LIKELIHOOD TO INSTALL WITHOUT THE PROGRAM IS >6: Given that you have not purchased <measures> before, why were you likely to purchase <measures> on your own without the program? [OPEN END]

In both cases, the evaluation analyst will assess responses to open ended questions and their consistency with the other questions; if warranted, based on clear additional information, the evaluator will adjust the original question score if required. If inconsistency occurs and the open-ended response does not resolve it, the original question response will be removed from the calculation. Final reports should document all instances of such adjustments. Optionally, additional participant questions can be included to trigger and resolve additional consistency checks.

Missing responses to specific questions (e.g., don’t know or refused) should be treated as “missing” for those particular questions, but the analysis retains the observation or case. The evaluation reports should note if this affects more than 5% of responses.

4.6 Multifamily Protocol

Multifamily energy efficiency programs typically offer direct installation of low-cost, energy-efficient measures in multifamily dwelling units, in addition to rebates for common area lighting retrofits, air sealing, insulation, and improvements to HVAC systems and controls. These programs have various target audiences from owners, managers, or developers of market rate multifamily housing to those operating lower income or assisted living housing. Across these groups, properties must generally have a minimum of between three and five units to qualify for the programs.

Most multifamily program savings are typically achieved by encouraging customers to install higher-efficiency equipment than they would have installed on their own. However, programs may also encourage early replacement of still functioning equipment that is less efficient, thus impacting the timing of the installation, so that savings is realized earlier. The incentive may also make it more affordable for customers to install a greater number of high-efficiency measures.

The basic method for estimation of free ridership and participant spillover (See Section 4.1.2) for these types of programs is based on participant self-report gathered through surveys. For common area and building shell components of the program, participants are property managers and owners responsible for building maintenance and renovation. However, depending on the program design for the in-unit component of the program and specifically the installation of efficient lighting, participating in the program (i.e., install program measures) may be driven by either property managers/owners or tenants or, potentially, both. This distinction is due to the fact that in some market-rate apartments, the tenant is responsible for decisions related to the installation of program measures, including light bulbs, while this is not common practice in income-qualified or assisted-living settings. For other in-unit measures, such as faucet aerators and low-flow showerheads, evaluators interview property managers/owners regarding program influence, as these measures are typically direct installed by program staff, and there is a limited likelihood of tenants making changes to these features.

4.6.1 Basic Method

Estimating NTG for rebated measures requires a more rigorous process than estimating NTG for free direct-install measures. In particular, the approach integrates an assessment of various program components that may have influenced the participant's installation of the measures. For discounted measures, the basic free ridership factor consists of the following two components:

- A Program Influence component, based on the participant's perception of the influence of various program elements—including the discount and the audit itself—on carrying out the energy-efficient project; and
- A No-Program component, based on the participant's likelihood of purchasing equipment, absent the program, of the same level of high efficiency as the unit installed at the same time in the absence of the program.

The free ridership method for discounted measures is identical to that used in the Prescriptive Rebate (With No Audit) protocol, with the one exception that the questions about program influence should be sure to include the audit itself as one of the program attributes. Evaluators should refer to Section 4.4.1.1.1 and 4.4.1.1.2 for details of the method. Figure 4-9 and Figure 4-10 also illustrate the algorithms for CFL/LED and non-CFL/non-LED measures⁷⁴.

⁷⁴ Evaluators should word the survey questions to reflect whether measures were free or purchased with an incentive.

Figure 4-9. Multifamily Free Ridership—Non-CFL/Non-LED Measures

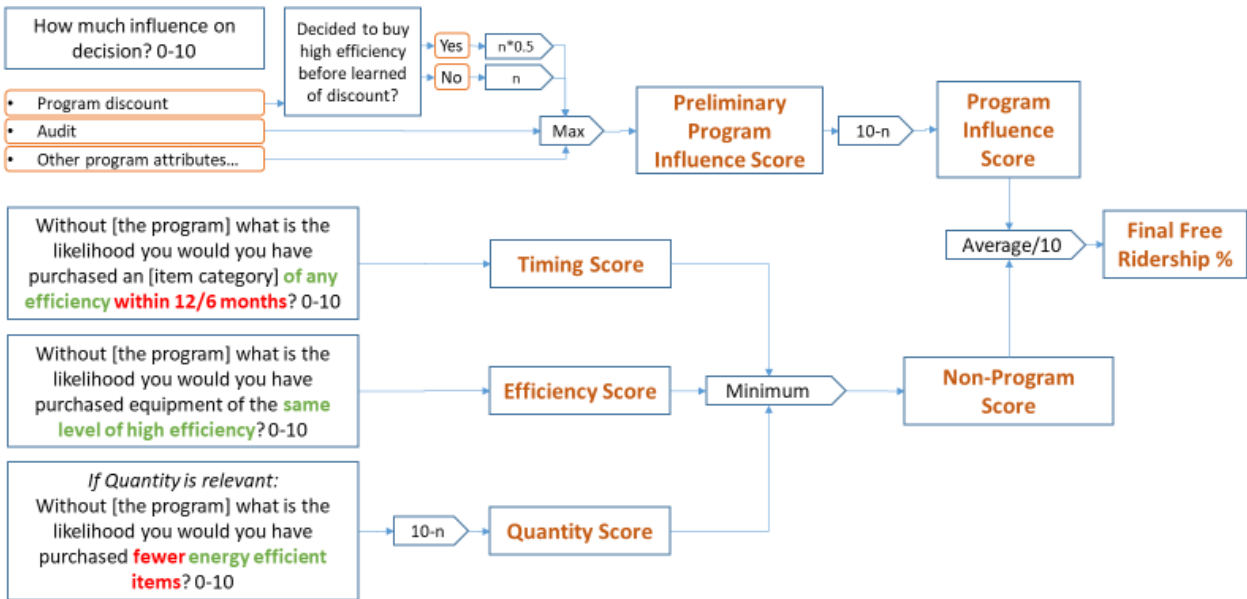
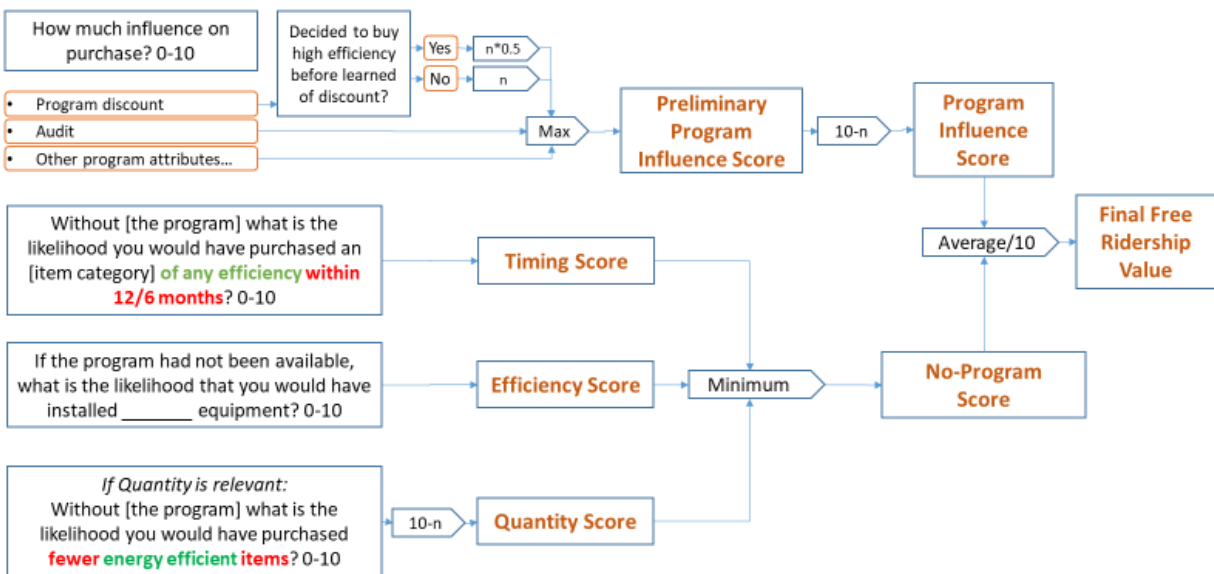

Figure 4-10. Multifamily Free Ridership for Property Managers—CFL/LED Measures



4.6.1.1 Consistency Checks

To address the possibility of conflicting responses (e.g., high likelihood to install the same measure without the program, high importance to program factors), the survey should include consistency checks that, at a minimum,

ask participants an open-ended question to address the program’s influence. For example⁷⁵:

- In your own words, please tell me the influence the program had on your purchase of the <insert measure name>.

The evaluation analyst will assess the responses to the open ended questions and their consistency with the other survey questions, and, if warranted based on clear additional information, will adjust the original question score. If the open-ended response does not resolve the inconsistency, responses to the original question should be removed from the calculation. The survey may include additional consistency check triggers and resolutions through additional participant questions. The final report should document how often the consistency check rules were triggered, how often adjustments were made to scores, and how often inconsistencies could not be resolved.

Missing responses to specific questions (including don’t know or refused) should be treated as missing for that particular question, but the analysis should retain that observation or case. Evaluation reports should note if this affects more than 5% of the responses.

4.6.1.2 Data Collection

A participant survey should be used as the primary source of data collected for estimating free ridership in residential multifamily programs. As discussed, evaluators may field surveys with owners, property managers, or tenants, depending on a program’s design and theory. Determining the appropriate audience from which to gather information for estimating free ridership depends on the program’s design, and, ultimately, the party responsible for deciding to install specific program measures.

4.7 Energy Saving Kits and Elementary Education Protocol

Energy Saving Kits and Elementary Education Programs aim to secure energy savings through the distribution of kits containing various energy-saving measures, including (but not limited to): high-efficiency lighting (CFLs or LED lamps); bathroom and kitchen faucet aerators; and low-flow showerheads. Energy Saving Kits operate as an opt-in program; customers can request a kit by completing an Internet or phone application. Elementary Education Program participants do not request a kit as kits are distributed to all students in a classroom.

Free ridership and participant spillover (See Section 4.1.2) estimations for both programs rely upon participant self-report information gathered through surveys, despite the differences in distribution models. This methodology can be used for other energy-saving kit programs, including kits with alternative distribution methods (e.g., kits dropped off at a participant’s home).

The following section contains a description of the basic NTG method used. Figure 4-11 illustrates the method.

⁷⁵ Evaluators should word the consistency check questions to reflect whether measures were free or purchased with an incentive.

Figure 4-11. Energy Saving Kits and Elementary Education Free Ridership

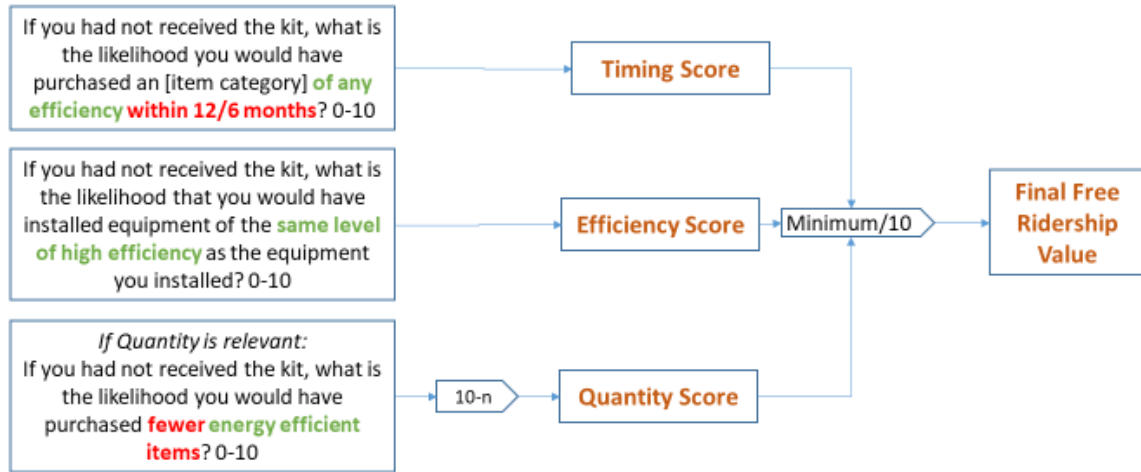

4.7.1 Basic Method

Free ridership calculations should include the following components: No-Program, Timing, and Quantity.

This approach provides several important benefits, such as the ability to derive a partial free ridership score based on the likelihood that similar actions would have taken place, even if the participant had not received a kit. For instance, partial scores can be assigned to customers with plans to install the measure, but the program at least influenced that installation, particularly in terms of timing (e.g., the program might have accelerated the installation) or quantity (e.g., the program might have led to the installation of additional measures).

Outlines of components and their associated survey questions follow:

- **Timing (T).** The first question computes the Timing (T) Score accounts for earlier installation of measures due to the program by asking respondents about their likelihood (0-10 scale) to have installed an item of any efficiency within 6 or 12 months, had they not received it through the program (12 months for a single or big ticket item and 6 months for less expensive items).
- **Efficiency (E).** This score reflects the likelihood that customers would have installed equipment of the same level of high efficiency as the unit installed absent the program. This is based on a question asking respondents to rate the likelihood that they would have installed measures of the same level of high efficiency had they not received them for free through the kit (on a 0 to 10 scale, where 0 is not at all likely and 10 is extremely likely). A higher likelihood value means a higher level of free ridership (i.e., a lower attribution level for the program).
- **Quantity (Q).** The question to compute the Quantity (Q) Score asks respondents about the likelihood that they would have installed fewer measures without the program. The response to this question is subtracted from 10 to compute the Quantity Score, as a lower score means a greater likelihood the respondent would have installed the same or a greater number of measures.

Given the low cost of measures provided in the energy-saving kits as well as the number of measures included in each kit, efforts have been made to streamline the free ridership battery to reduce the respondent’s burden. As such, the overall Final Free Ridership Value per measure can be calculated by taking the minimum of the Timing, Efficiency, and Quantity Scores, as shown in the following equation:

$$\text{Free Ridership (FR)} = \text{Min}(T, E, Q)$$

Missing responses to specific questions (e.g., don’t know or refused) should be treated as “missing” for that particular question. Despite missing responses, the case will be retained in the analysis (pairwise deletion). The

evaluation reports should present the percent missing for each of the three questions.

4.7.1.1 Data Collection

Evaluators should use a participant survey as the primary data collection source for estimating free ridership in Energy Saving Kits and Elementary Education Programs. As a general rule, a free ridership rate should be calculated for each separate kit component, and then be weighted by savings to determine the program-level results.

4.8 Residential New Construction Protocol

Residential New Construction programs typically offer builder training, technical information, marketing materials, and incentives to builders for the construction of eligible homes. Eligible homes must meet specific standards, designed to achieve energy efficiency levels above local building codes. Programs may use different tiers of standards to meet correspondingly different incentives.

The basic method for estimating free ridership and participant spillover for these programs is based on builder participant self-reporting, gathered through surveys.

The following section describes the basic method used.

4.8.1 Basic Method

For this program, a free rider is a builder who would have constructed a home at the program's efficiency level in the program's absence. Given the multiple methods available to achieve desired home energy efficiency levels, survey questions consider the builder's likelihood of meeting the same energy efficiency standard, rather than whether or not the builder would have installed certain energy efficiency measures. Figure 4-12 (below) illustrates the method in more detail.

Evaluators assess Program Influence by asking respondents, on a scale from 0 (not at all important) to 10 (extremely important), how important they found various program elements in deciding to build to specific energy efficiency standards. The number of elements included vary, depending on the program's design. Logic models, program theory, and staff interviews typically inform the list of program elements included. Programs typically use the following elements to influence builder actions: marketing materials; incentives or rebates; contacts with HERS Raters; and technical assistance.

In addition to asking about specific program influences, surveys should ask builders whether they planned to build homes to the same standard before learning of the program.

Figure 4-12. Residential New Construction Free Ridership

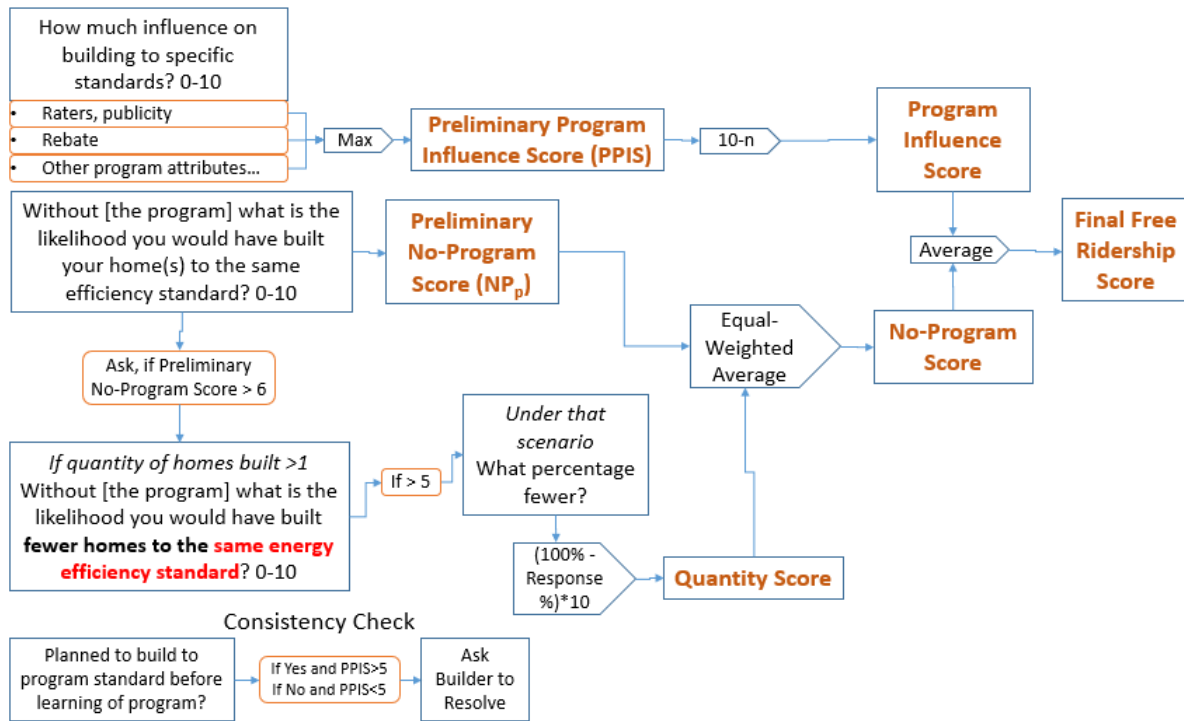

4.8.1.1 Calculation of the Program Influence Score

The Program Influence Score (PI) equals 10 minus the maximum influence rating for any program element rather than, for example, the mean influence rating. This is based on the rationale that if any given program element had a great influence on the respondent’s action, the program itself had a great influence, even if other elements had less influence.

4.8.1.2 Calculation of the No-Program Score

Evaluators calculate the No-Program score using a set of questions that ask respondents to gauge their likelihood of building homes to the same standards and in the same quantities had the program not existed. Three separate responses are considered in calculating the No-Program Score:

- The likelihood, on a scale of 0 to 10, that the builder would have built their homes to the same efficiency standard (Preliminary No-Program Score (NP_p))
- If that likelihood is greater than 6, the likelihood of fewer homes being built to the same efficiency standard.
- If that likelihood is greater than 6, the response to the question “for that scenario, what percentage of fewer homes would be built to the standard?” (Quantity Score = (100% - % answer) * 10, which will be a number between 0 and 10)

The resulting No-Program (NP) Score is calculated as follows:

$$NP = Mean(NP_p, Q)$$

The overall Free Ridership Value derives from the average of the PI and NP scores, as shown in the following formula:

$$FR = Mean(PI, NP)$$

4.8.1.3 Consistency Checks

To address the possibility of conflicting responses (e.g., the high likelihood to build to the same efficiency standards

without the program, the high importance of program factors), the survey should include, at a minimum, consistency checks that ask participants an open-ended question to address the program’s influence. For example:

- In your own words, please tell me the influence the program had on your building practices.

If a high (>6) Preliminary Program Influence Score (PPIS) results, yet the builder planned to meet the same efficiency standard prior to learning of the program; or if the Preliminary Program Influence Score is lower (<7), and the builder did not plan to build to the standards prior to learning of the program, the survey should include a question to determine why this occurred, using wording that gets at the following inconsistencies:

- IF Preliminary Program Influence Score is >6 and Builder planned to meet the same efficiency standard prior to learning OF THE PROGRAM: Given that you had plans to meet the standard prior to learning about the program, why do you think the <program elements> were influential in your meeting the standard? [OPEN END]
- IF Preliminary Program Influence Score is <7 and Builder had no plans to meet the same efficiency standard prior to learning of the program: Given that you had no plans to meet the standard prior to learning about the program, why do you think the <program elements> were not more influential in your meeting the standard? [OPEN END]

The evaluation analyst will assess the responses to the open ended questions and their consistency with the other survey questions, and, if warranted based on clear additional information, will adjust the original question score. If the open-ended response does not resolve the inconsistency, responses to the original question should be removed from the calculation. The survey may include additional consistency check triggers and resolutions through additional participant questions. The final report should document how often the consistency check rules were triggered, how often adjustments were made to scores, and how often inconsistencies could not be resolved.

Missing responses to specific questions (including don’t know or refused) should be treated as missing for that particular question, but the analysis should retain that observation or case. Evaluation reports should note if this affects more than 5% of the responses.

4.8.2 Participant Spillover

Participant spillover occurs when, due to program participation, a builder increases the energy efficiency of homes built outside the program (but inside a utility’s service territory) by adopting certain building practices used in participating homes. Participant spillover can be calculated based on participant builder survey questions that ask builders about homes built within the utility service territory but outside the program. Survey questions ask whether the builder increased the energy efficiency standards of non-program homes after participating in the program, and the number of homes they applied these increased standards to, within the utility’s service territory. Depending on the program characteristics, spillover should be measured as changes in specific building practices or as installation of specific measures. The text below assumes the program has been targeted at modifying building practices.

Spillover may be recorded depending on responses to the following questions:

1. How important was your experience in the <PROGRAM ADMINISTRATOR’S> program in your incorporating this building practice your other homes, using a scale of 0 to 10, where 0 is not at all important and 10 is extremely important?
2. If you had not participated in the <PROGRAM ADMINISTRATOR’S> program, how likely is it that you would still have incorporated this building practice using a 0 to 10, scale where 0 means you definitely WOULD NOT have implemented this practice and 10 means you definitely WOULD have implemented this practice?

Responses to the first question establish the Practice Attribution Score 1, and responses to the second question establish the Practice Attribution Score 2. Spillover may be program-attributable for building practices with self-report data meeting the following condition:

$$\text{Spillover Score} = (\text{Practice Attribution Score 1} + (10 - \text{Practice Attribution Score 2}))/2 > 5.0$$

For responses meeting these conditions, an evaluator determines that specific building practices referenced in the question are attributable to the program; otherwise, the evaluator determines that specific building practices

referenced in the question are not attributable to the program. The attribution criteria represent a threshold approach, in which energy impacts associated with building practices program participants implement outside the program are either 100% program-attributable or 0% program-attributable.

For each building practice discussed, builders will be asked how they know the building practice is more efficient than other options. If the respondent can identify the building practice as ENERGY STAR or name an efficiency level that the evaluator confirms as above the minimum federal standard, or if they identify a technology that the evaluator can confirm is above the minimum federal standard, this counts towards participant spillover.

Finally, depending on the building practice cited by the builder, follow-up questions should ask customers to provide reasonable information to allow the evaluator to estimate the amount of savings using IL-TRM protocols, such as quantity of appliances or the location and amount of insulation.

To calculate the spillover energy and demand savings for these actions, further questions should be asked to assess the gross savings of the building practice, through the appropriate version of the IL-TRM, if available, and the number of homes to which it applied. To develop the Spillover Rate, the total energy and demand impacts from the sampled participants who implemented efficient building practices in other homes due to participation in the program is summed, and then this sum is divided by the total ex post gross impacts from all participants who took the survey.:

$$\text{Participant Spillover Rate (PSO)} = \frac{\text{Sum of Energy or Demand from Additional EE Practices}}{\text{Sample Ex Post Gross Energy or Demand Impacts}}$$

The equation used to adjust the Core NTGR based on participant spillover is as follows:

$$NTGR = (1 - FR + PSO)$$

4.8.2.1 Sample

The sample for a spillover survey should be a random sample of current and up to one year previous program participants. Regardless of the year of participation, spillover should be measured within the set of homes that were completed within 12 months of the survey date.

4.8.3 Builder Nonparticipant Spillover

In addition to participant free ridership and spillover, new construction programs may create NPSO through builders exposed to the program but not actually participating. Rather, they implement some or all of the efficiency measures incorporated through the program in order to compete with builders that are participating.⁷⁶ NPSO caused by builders can be determined by surveying two groups of builders:

- “Drop out” builders, who participated in the program previously but have not participated in the past 12 months.
- True nonparticipating builders that report they were aware of the program or that other builders were taking steps to improve new home efficiency, but had never participated.

Surveys ask nonparticipating builders if their knowledge of other builders’ increased focus on energy efficiency influenced their building practices and in what manner, to quantify the program’s impact on nonparticipating homes. The survey questions will first identify specific building practices that go beyond the implemented energy code for the specific jurisdiction in which the builder is active. Table 4-8 lists the latest building energy code in place for most areas of Illinois. Evaluators should make efforts to ensure the building code under enforcement for each jurisdiction is used as the baseline when evaluating spillover savings.

⁷⁶ NPSO also can arise from nonparticipating customers as a direct result of general energy efficiency education and promotion efforts. A separate protocol addresses such NPSO. Care should be taken to ensure the different approaches do not double-count NPSO.

Table 4-8. IECC 2015 Building Energy Code

Component	IECC 2015
Thermostat	Heating 72F; Cooling 75F Programmable Thermostat
Ceiling	U-0.026
Walls	U-0.060
Floors	U-0.033
Slab	R-10, 2ft
Windows	U-0.32
Infiltration	5ACH50
Duct Leakage	4CFM/100CFA
Duct Insulation	R-8 Attic Supply, R-6 Otherwise
Heat Pump	8.2 HSPF
Furnace	80 AFUE
Component	IECC 2015
Boiler	82 AFUE
AC	13 SEER
Lighting	75% CFL
Appliances	RESNET Default
Gas Water Heat*	0.58 EF
Electric Water Heat*	0.92 EF

*EF varies based on water heater storage volume and draw pattern; values in table for 40 gallon water heater with medium draw pattern.

For each component that is more efficient than code, the following additional questions are asked:

1. How many homes did you sell in <period> that incorporated this upgrade?
2. Of these homes, how many would have incorporated this upgrade, had the <program> not existed?

Evaluators should ensure that nonparticipant builders receive sufficient time to collect specific data and not rely on “guesses” to respond. Responses should also clarify whether sales counts are specific to the utility service territory in question.

The following steps calculate the program’s nonparticipant builder spillover percentage:

1. Compute the difference between the total reported number of efficiency upgrades sold and the total that would have been sold in the program’s absence to obtain the total number of upgrades by type of upgrade for that builder.
2. Multiply the total net number of upgrades of each type sold by each surveyed builder by the average gross unit savings for each upgrade type.
3. Sum the result for each builder from the previous step, and weight the results by the ratio of the population of non-active builders to the sample to compute the total spillover energy over the program period.
4. Divide the spillover energy savings by program gross savings.

Should a general population survey be implemented for nonparticipant spillover, care should be taken to ensure spillover is not double-counted.

5 Cross-Sector Protocols

The following sections include protocols that may be applicable to programs in the residential as well as in the commercial, industrial, and public sectors. Table 3-1 Commercial, Industrial, and Public Sector Programs and Table 4-1 Residential and Low Income Programs present information regarding the applicability of these protocols to specific programs.

5.1 Combining Participant and Trade Ally Free Ridership Scores

For a program where trade allies play a prominent role in delivering the energy efficiency measure and promoting the program, an estimate of free ridership from trade allies can be combined with one from participants to form a combined free ridership value. This section discusses combining a **program-level** free ridership score from trade allies with a program-level free ridership score from participants.

If an evaluation uses this approach, the evaluator's NTG report should present the conditions that support the argument that the combined value is more likely to be reflective of reality. That argument should consider the following topics:

1. **Trade Ally Role.** What role do the trade allies play in the program? How were participating trade allies chosen? How might they differ from nonparticipating trade allies? Why does that support the proposition that their view on free ridership is accurate and reasonably unbiased?
2. **Participant Role.** What role do the participants play in deciding which measures are installed and why does that support the proposition that their view on free ridership is accurate and reasonably unbiased?
 - a. For example, the participant's role in the decision **may** be significantly less in some types of programs like new construction or multifamily direct install programs. (The participant free ridership data collection method may already account for this by, for example, treating the building owner as the participant rather than the tenants.)
3. **Market Conditions.** What conditions exist in the market that support the proposition that either the trade allies' view or the participants' view on market behavior may be more accurate?
 - a. For example, if the market was in its infancy before the program began and as a result participants' ability to take the energy efficiency action was limited, the trade allies may have a more accurate view on the counterfactual than the participants.
4. **Bias.** What are the hypothesized biases of the participants and trade allies? Where do they stem from? What evidence is there that they exist? How well has the data collection approach sought to mitigate that bias?
5. **Offsetting Bias.** Do the hypothesized biases of participants and trade allies offset each other, or do they move the free ridership value in the same direction?

5.1.1 Trade Ally Free Ridership Calculation

The NTG protocols do not yet contain a standardized approach for measuring free ridership from trade allies. That approach should be developed for future versions of the TRM. In the meantime, if an evaluation team decides to estimate trade ally free ridership, they should collaborate with other Illinois evaluators on the survey design and calculation algorithm.

5.1.2 Triangulation

Where appropriate, evaluators should combine participant and trade ally free ridership values by weighting each value in the final result. The weighting of each value should be based on considerations of the likely bias, accuracy, and representativeness of the results. The following presents one approach for determining weights. This is an example only. The evaluator should create an approach appropriate for the program.

Example. Combined participant and trade ally free ridership results by rating the analysis methodology and data collected using responses (rated on a scale of 0 to 10) to the following three questions:

1. All things being equal, on a scale of 0 to 10, with 0 being not at all likely and 10 being extremely likely, how likely is the approach to provide a more accurate estimate of free ridership?
2. Similarly, on a scale of 0 to 10, with 0 being not at all valid and 10 being extremely valid, how valid and reliable is the data collected and the analysis performed (i.e., consider non-response bias, missing data (e.g., whether data collected was based on recollection or record keeping?)
3. On a scale of 0 to 10, with 0 being not at all representative and 10 being extremely representative, how representative is the sample (accounting for sampling error {confidence and precision}, and non-response bias, and any sample frame bias)?

The weight for each free ridership estimate is the average score for that estimate divided by the sum of the average scores for both estimates.

Table 5-1 provides an example scoring illustrating the calculated weights.

Table 5-1. Example Triangulation Weighting Approach

NTG Triangulation Data and Analysis	Participants	Trade Allies
1. How likely is this approach to provide an accurate estimate of free ridership?	6	8
2. How valid is the data collected/analysis?	3	5
3. How representative is the sample?	8	10
Average Score	5.7	9
Sum of Averages	14.7	14.7
Weight	39%	61%

5.2 Spillover Measured Through Trade Allies

Many energy efficiency programs rely on trade allies to help spread program awareness and promote energy efficiency among their customers. Some programs establish lists of participating trade allies and provide trade allies with training, education, and/or marketing materials. Spillover might occur when a trade ally’s business practices are influenced by a program but at least some of their energy efficient installations do not receive a program incentive.

For the purposes of measuring trade ally spillover, we define trade allies as (1) retailers, contractors or other market actors who work with end-user customers on the selection and installation of energy-using equipment; and (2) distributors who supply equipment to stores and other market actors, rather than to end-user customers. For the purposes of this section, manufacturers are not included in the definition of trade allies.⁷⁷ In addition, we differentiate between the following types of trade allies:

1. Active Trade Allies
 - a. Trade allies who were active in the program during the evaluation period and appear in program tracking databases. The tracking data contains information on the quantity of incented measures associated with these trade allies and their savings.
2. Inactive Trade Allies
 - a. Trade allies who are on the utility’s trade ally list (and have received at least some utility training or education) but who were not active during the evaluation period and do not appear in program savings tracking databases for the evaluation period;
 - b. Trade allies who were previously active in the program (and may have been on the utility’s trade ally list) but have dropped out; and/or
 - c. Trade allies who have never been active in the program and were never on the utility’s trade ally list.

⁷⁷ The exclusion of manufacturers from the definition of trade ally does *not* suggest that manufacturers cannot create spillover. Rather, manufacturers are excluded because the methodologies outlined in this section do not apply to them.

When deciding whether to conduct trade ally spillover research, the evaluator should consider the following:

- **Likelihood of trade ally spillover:** When limited evaluation resources are available, the evaluator should weigh the likelihood of trade ally spillover against the cost of the analysis when prioritizing evaluation efforts. E.g., programs that provide incentives, but no training or education are less likely to generate spillover than programs that do provide training or education. Similarly, spillover from active trade allies is generally more likely than spillover from inactive trade allies, and spillover from inactive trade allies who have previously been active in the program is generally more likely than spillover from inactive trade allies who have never been active in the program.
- **Potential double-counting of spillover reported by end-use customers and trade allies:** Spillover from active trade allies and spillover from inactive trade allies are mutually exclusive, i.e., as long as the populations and samples are correctly defined, there is no danger of double-counting spillover from these two groups (see also discussion in Section 2.2). However, if the evaluator measures spillover through trade allies and end-use customers for the same evaluation period, care needs to be taken to avoid double-counting. Evaluators should clearly document potential double-counting of spillover and the steps taken to avoid it.

The following subsections provide suggested approaches for measuring spillover from active and inactive trade allies. Different approaches are outlined for these two groups because of the different types of data available for each of them. For active trade allies, program tracking data contains information on their program activity (the quantity of incented measures associated with each active trade ally and their savings). This data allows for a more rigorous spillover methodology than can be used for inactive trade allies, for whom this information does not exist.

5.2.1 Spillover from Active Trade Allies

Trade allies that are active in an energy efficiency program are more likely to create spillover than inactive trade allies, as their exposure to any program messaging and training/education is likely to be current and therefore more influential on their business practices. Active trade allies may create spillover if their program participation changes their business practices and leads to the completion of non-incented energy efficient projects that would otherwise not have happened. For example, as a result of program training, a trade ally might feel more comfortable talking about the benefits of energy efficiency and recommend energy efficient solutions more often. If these recommendations result in energy efficient projects, but no incentive is claimed, spillover from inactive trade allies may be present.

For active trade allies, the spillover methodology varies slightly for downstream programs and midstream programs. Approaches for both types of program are discussed below.

5.2.1.1 Downstream Programs

Surveys can be used to ask active trade allies if the program influenced their sales of high-efficiency equipment to participating or nonparticipating customers and to quantify the program’s impact on their high-efficiency sales. To assess if a sampled trade ally created spillover, the following screening criteria are recommended (the order of these may be adjusted by the evaluator):

1. The percentage of the trade ally’s installations/sales that are high efficiency and/or the total volume of high efficiency installations/sales increased since the trade ally became exposed to the program.
2. The trade ally rated the program as important to at least one of these (as described above) high efficiency installation increases.
3. The trade ally installed/sold at least some high efficiency equipment or products during the evaluation period that did not receive an incentive.
4. The trade ally’s recommendation was influential in the customers’ choice of high efficiency equipment/product over standard efficiency equipment/product in instances where the equipment did not receive a program incentive.
5. The open-ended response about why customers with eligible projects do not receive an incentive supported that the non-incented high efficiency installations can be considered spillover.

Sampled trade allies who do not pass one of the above screening criteria do not qualify for spillover and may be skipped out of the rest of the spillover module.

To quantify spillover for each sampled trade ally, the survey collects information on the percentage of the trade ally’s total equipment installations/sales (in terms of projects or measures) that was (1) standard efficiency, (2) high efficiency that DID receive a program incentive, and (3) high efficiency that DID NOT receive a program incentive. Based on these responses, the share of a trade ally’s high efficiency installations/sales that received an incentive can be calculated as follows:

$$\frac{\% \text{ of TA's High Efficiency Equipment that Received Incentive}}{\% \text{ High efficiency that DID receive a program incentive (2)} + \% \text{ High efficiency that did NOT receive a program incentive (3)}} = \frac{\% \text{ High efficiency that DID receive a program incentive (2)}}{\% \text{ High efficiency that DID receive a program incentive (2)} + \% \text{ High efficiency that did NOT receive a program incentive (3)}}$$

With this data, and the trade ally’s savings from the program tracking database, the following equation is used to calculate the savings of high efficiency equipment that did not receive an incentive:

$$\text{Savings of Non-Incented High Efficiency Equipment} = \left(\frac{\text{Savings from Program Database}}{\% \text{ of TA's High Efficiency Equipment that Received Incentive}} - \text{Savings from Program Database} \right) * \text{Size Adjustment}$$

The last term in the above equation is a size adjustment that accounts for the possibility that savings from non-incented projects/measures might be different from incented ones. Information on the relative size of incented versus non-incented projects/measures is also collected in the survey.

Using this approach, spillover savings are considered to be equal to the savings of non-incented, high efficiency equipment/products, as calculated in the equation above. To compute the program spillover percentage for active trade allies, the following steps are used:

1. **Develop the spillover ratio for sampled trade allies** by summing their spillover savings and dividing this total by the program-tracked savings associated with the sampled trade allies.
2. **Develop spillover savings for the population of active trade allies** by applying the spillover ratio from Step 1 to all program savings associated with a trade ally (whether a survey respondent or not).
3. **Develop the overall spillover ratio for active trade allies** by dividing the trade ally spillover estimate from Step 2 by total program savings (whether associated with a trade ally or not).

5.2.1.2 Midstream Programs

Similar to downstream programs, surveys can be used to ask active trade allies in midstream programs if the program influenced their sales of high-efficiency equipment to participating or nonparticipating customers and to quantify the program’s impact on their high-efficiency sales. To assess if a sampled midstream trade ally created spillover, the following screening criteria are recommended (the order of these may be adjusted by the evaluator):

1. The percentage of the trade ally’s sales that are high efficiency and/or the total volume of high efficiency sales increased since the trade ally became exposed to the program.
2. The trade ally sold at least some high efficiency equipment or products during the evaluation period that did not receive an incentive.
3. The trade ally’s recommendation, marketing, or equipment/product stocking or placement was influential in the customers’ choice of high efficiency equipment/product over standard efficiency equipment/product in instances where the equipment did not receive a program incentive.

Sampled trade allies who do not pass one of the above screening criteria do not qualify for spillover and may be skipped out of the rest of the spillover module.

To quantify spillover for each sampled midstream trade ally, the survey collects information on the percentage of the trade ally’s total equipment sales (in terms of projects or measures) that was (1) standard efficiency, (2) high efficiency that DID receive a program incentive, and (3) high efficiency that DID NOT receive a program incentive.

Based on these responses, the share of a trade ally’s high efficiency sales that received an incentive can be calculated as follows:

$$\frac{\% \text{ of TA's High Efficiency Sales that Received Incentive}}{\% \text{ High efficiency that DID receive a program incentive} + \% \text{ High efficiency that did NOT receive a program incentive}} = \frac{\% \text{ High efficiency that DID receive a program incentive}}{\% \text{ High efficiency that DID receive a program incentive} + \% \text{ High efficiency that did NOT receive a program incentive}}$$

Through additional survey questions,⁷⁸ the evaluator should develop an attribution percentage, i.e., the proportion of non-incented high efficiency projects or measures that are attributable to the program. With this data, and the trade ally’s savings from the program tracking database, the following equation is used to calculate the trade ally’s spillover savings:

$$\text{Spillover Savings} = \frac{\text{Savings from Program Database}}{\% \text{ of TA's High Efficiency Sales that Received Incentive}} - \text{Savings from Program Database} * \text{Size Adjustment (if applicable)}$$

The last term in the above equation is a size adjustment that accounts for the possibility that savings from non-incented projects/measures might be different from incented ones. Information on the relative size of average energy savings of incented versus non-incented projects/measures is also collected in the survey if the evaluator expects a potential difference in relative size.

To compute the program spillover percentage for active midstream trade allies, the following steps are used:

1. **Develop the spillover ratio for sampled trade allies** by summing their spillover savings and dividing this total by the program-tracked savings associated with the sampled trade allies.
2. **Develop spillover savings for the population of active trade allies** by applying the spillover ratio from Step 1 to all program savings associated with a trade ally (whether a survey respondent or not).
3. **Develop the overall spillover ratio for active trade allies** by dividing the trade ally spillover estimate from Step 2 by total program savings (whether associated with a trade ally or not).

5.2.2 Spillover from Inactive Trade Allies

Inactive trade allies may create spillover if they are exposed to the program but do not directly facilitate program participation, i.e., they did not complete any projects through the program during the evaluation period. Rather, they promote and stock higher-efficiency equipment due to the influence of the program on the market.

Surveys can be used to ask inactive trade allies if the program influenced their sales of high-efficiency equipment to participating or nonparticipating customers and to quantify the program’s impact on their high-efficiency sales. The general questions take the following form:

- Q.1: How many <measures> did you sell in <utility>’s service territory in <period>?
- Q.2: How many of them were <efficiency level> or higher?
- Q.3: Had the <program> not existed, how many <measures> of <efficiency level> or higher do you think you would have sold in <utility>’s service territory?

Evaluators should attempt to allow trade allies sufficient time to collect specific data (e.g., by sending information ahead of the interview or conducting additional follow-up; this might require providing incentives as inactive trade allies tend to be hard-to-reach) and not rely on “guesses” to respond. Additional questions should be included to document how the program influenced sales of additional energy efficient measures and why these measures did not receive an incentive.

For programs that offer a number of different measures, the evaluator should select and ask about a small number

⁷⁸ As some trade allies may find it difficult to directly quantify the program’s attribution effect on non-program sales, the evaluator may need to use a series of questions to guide the trade ally to provide an estimate of the overall attribution. Questions may include asking about what factors influence sales of non-program efficient equipment/products and how the program influences individual factors to provide context for an overall attribution estimate.

of measures or measure groups that are most likely to generate spillover, e.g., the program’s highest impact measures. The selection of trade allies to include in this research will depend on the measures selected, e.g., if the highest impact measures are lighting measures, the population of trade allies from which to sample should be lighting contractors.

The following steps are used to calculate the spillover percentage for inactive trade allies:

1. **Develop the total number of spillover units for each trade ally** by computing the difference between the total reported number of high-efficiency units sold and the number that would have been sold in the program’s absence, for each measure type.
2. **Develop the total spillover savings for each trade ally** by multiplying the trade ally’s total number of spillover units (from Step 1) by the average gross unit savings, for each measure type.
3. **Compute the total spillover savings for the program period** by summing the spillover savings from all sampled trade allies (from Step 2) and multiplying this sum by the ratio of the population of inactive trade allies to the sample, for each end-use.
4. **Compute the program spillover percentage** by summing the spillover savings for all end-uses (from Step 3) and dividing this sum by program gross savings.

It should be noted that the methodology for inactive trade allies requires the evaluator to quantify the number of trade allies in the population. Depending on which types of inactive trade allies are targeted by the research, determining the size of the population may be challenging and may lead to uncertainty in the results. When targeting trade allies that are on the utility’s trade ally list (but are not active) or those who have been active in the past but have dropped out, program records allow for accurate estimation of the population size. However, when targeting trade allies that have never been active in the program and were never on the utility’s trade ally list, secondary market data is required to develop estimates of population size. The evaluator should carefully document the target population for any inactive trade ally research, data sources used to quantify the population size, and any uncertainty associated with their estimates.

5.3 Consumption Data Analysis Protocol

This protocol refers to impact analyses that use consumption data from customer’s monthly bills (commonly referred to as billing analysis) or AMI meter reads⁷⁹ to estimate program energy savings. This protocol discusses different consumption data methods and where they fall on the NTG spectrum with respect to participant spillover, nonparticipant spillover, and free ridership; this has implications for whether a NTGR needs to be applied after the consumption data analysis estimate is obtained in order to achieve an estimate of net savings. Decisions of whether to apply a NTGR after conducting a consumption data analysis should be made by the evaluator on a case-by-case basis taking into account the guidelines of this protocol for when these methods are net, gross, or somewhere in between.⁸⁰ The remainder of this section discusses NTG for various consumption data analysis methods and then goes through some details of the various analysis methods.

In general, consumption data analysis methods split into two approaches. One approach is to use a comparison group in a randomized control treatment (RCT) design, a random encouragement design (RED) or a quasi-experimental design. These comparison group approaches can, under the right circumstances, be used to directly estimate net savings eliminating the need for a NTGR adjustment. A second approach is to estimate savings without a comparison group (for example, using a pre/post regression model for program participants). Approaches without a comparison group produce gross savings and must be adjusted by a NTGR to achieve net savings.

In consumption data analysis, energy consumption of the treatment and control groups can be appropriately

⁷⁹ Benefits of using AMI data can include: having more observations per customer, which may improve model precision; obviating concerns over billing periods with differing numbers of days; and, for hourly models, providing the ability to observe intraday load shifting in addition to energy savings.

⁸⁰ For example, it is generally accepted that programs for income qualified customers have little to no free ridership as these customers are unlikely to install the measures without the incentive of the program. For specific guidance on income qualified programs see Section 3.3.1.

compared through a regression analysis, using time-series observations on the usage of individual customers in the treatment and comparison groups during the pre- and post-treatment periods. Due to the combined time-series/cross-section structure of such data sets, panel regression techniques can be used.⁸¹

In general, consumption data analysis methods are best suited to the following situations:

1. When the expected net savings per participant (i.e., the effect size) are large or when large participant/nonparticipant sample sizes are possible.
2. When the program can be designed using a randomized controlled trial (see Section 5.3.5).
3. Programs where nonparticipant spillover is expected to be trivial within the comparison group.
4. Cases where self-selection bias can be effectively controlled for.

5.3.1 Consumption Data Analysis and NTG

Different consumption data analysis methods produce different savings estimates in terms of the NTG spectrum, as summarized in Table 5-2. These methods will always yield gross savings with respect to nonparticipant spillover and net savings with respect to participant spillover. However, the savings estimates may be net, gross, or somewhere in between with respect to free ridership, depending on the evaluation technique.

Table 5-3. NTG Summary for Consumption Data Analysis

Consumption Data Analysis Method	Free Ridership	Participant Spillover*	Nonparticipant Spillover**
Randomized Controlled Trial (RCT)	✓	✓	§
Random Encouragement Design			
No Instrumental Variable (IV)	†	✓	§
IV	†	✓	§
IV w/ Inverse Mills Ratio (IMR)	†***	✓	§
Quasi-Experimental Design (QED) ****			
Matching			
To Nonparticipants	†*****	✓	§
To Prior or Future Participants	§	✓	§
Regression Discontinuity (RD)	✓	✓	§
Variation-in-Adoption (VIA)	§	✓	§
Without a Comparison Group	§	✓	§
§ Indicates not accounted for (gross) ✓ Indicates fully accounted for (net) † Indicates partially accounted for (between net and gross) * Participant spillover within the analysis timeframe in the same building and fuel type is captured. Other sources of participant spillover may not be captured. See the subsection on participant spillover below for details. ** Nonparticipant spillover is not captured as a positive in consumption data analysis and may actually reduce the estimate of savings if it occurs within the comparison group. See the subsection on nonparticipant spillover below for details. ***This method has been tested in simulation but needs further use in practice.			

⁸¹ “Panel” refers to the data set consisting of time-series observations on energy consumption of a cross-section of treatment and control customers. Panel estimation techniques refer to the model’s inclusion of terms that control for individual customer heterogeneity (e.g., customer fixed effects or a lagged dependent variable), and cluster-robust standard errors, which can accommodate differing error variances across customers and an intracustomer correlation of errors.

**** Note that this is a non-exhaustive list of QED evaluation techniques.

***** As noted in first few paragraphs of Section 5.3, these comparison group approaches can, under the right circumstances, be used to produce an estimate of net savings, eliminating the need for a NTGR adjustment (see Goldberg et al., 2017).

When consumption data analysis methods are being used to update the TRM, the update should explicitly state how a NTGR should be applied to the given measure or program in the future. The language used should consider different program delivery mechanisms (which often have different NTG values) and how stable the NTG value is likely to be over time (thus allowing for consideration of how frequently it should be updated).

5.3.2 Nonparticipant Spillover

Nonparticipant spillover is never captured by consumption data analysis, making these savings estimates gross with respect to nonparticipant spillover (i.e., nonparticipant spillover is not accounted for by the estimate directly from the consumption data analysis without further adjustment). To the extent that nonparticipant spillover occurs in the comparison group being used for evaluation, the effect of the program may be underestimated as the difference between the participant group and the comparison group is decreased by the amount of nonparticipant spillover. If nonparticipant spillover is expected to be large (based on the best research available or given the program's logic model) and occur within the evaluation comparison group, that may be a reason to use other methods for evaluating savings. If a billing analysis is done in these cases, a traditional nonparticipant spillover analysis (using techniques like nonparticipant surveys or interviews) should be used to help quantify this effect (these analyses are discussed in various subsections of Chapter 4 of this protocol). Within the comparison group, it can also be difficult to distinguish the effects of nonparticipant spillover, free ridership, and market transformation as all of these effects increase uptake of a measure without going through the program among the nonparticipant group.

In cases where nonparticipant spillover is not expected to occur in the comparison group but may occur in the broader population (for example, if we go from a pilot evaluation where measures were restricted among the comparison group to a full program deployment), adjustments for nonparticipant spillover (or justification for why there is no nonparticipant spillover) should be made as appropriate on a program-by-program basis.

5.3.3 Participant Spillover

Participant spillover is captured by consumption data analysis, making these savings estimates net with respect to participant spillover (i.e., participant spillover is accounted for by the estimate directly from the consumption data analysis without further adjustment). This occurs because consumption data analysis measures all changes in participant usage (captured by the utility billing system or AMI meter reads) regardless of whether the changes are related to the program. A few caveats apply:

1. Consumption data analysis does not capture participant spillover that occurs outside the home or business being analyzed. For example, spillover at a participant's vacation home or spillover at other facilities owned by the same firm.
2. Consumption data analysis does not capture participant spillover that occurs in a different fuel type. For example, if the analysis is done on electric data but there is participant spillover into natural gas.
3. Consumption data analysis does not capture participant spillover that occurs outside the analysis period (typically a one-year period).

If these sources of participant spillover that are not captured are expected to be large (based on the best research available or given the program's logic model), adjustments or additional analysis to capture these types of participant spillover may be required.

5.3.4 Free Ridership

With respect to free ridership, consumption data analysis can produce savings estimates that are net, gross, or somewhere in between (i.e., free ridership can be fully, not at all, or partially accounted for by the estimate directly from the consumption data analysis without further adjustment). Where they fall depends on whether the comparison group accounts for (or nets out) free ridership in the estimation. For a summary of where each method falls see Table 5-3 above.

Methods that yield gross savings estimates with respect to free ridership have no comparison group or have a comparison group that is made up of other (prior or future) participants. In these cases, a free ridership adjustment (or justification of why there is no free ridership) is necessary. These methods include:

- Matching to older or newer participants⁸²
- Variation-in-adoption (VIA)⁸³
- Any method without a comparison group

Methods that yield net savings estimates with respect to free ridership have a nonparticipant comparison group that has the same level of free ridership as the participants. In these cases, the comparison group is engaging in energy efficiency activities at the same rate as the participant group would have without the program. This nets out the free ridership and means no free ridership adjustment is necessary. These methods include:

- Randomized controlled trial (RCT)
- Regression discontinuity (RD)
- Random encouragement design (RED) under at least one of the following conditions:
 - Analysis is done using instrumental variables with an inverse mills ratio⁸⁴
 - Designs where only the encouraged group can join the program (and as such the participants who join the program include only compliers and not always takers⁸⁵)
 - There is no relationship between how much energy a customer will save by participating and their inclination to participate

Methods where there is a nonparticipant comparison group that is expected to have a different level of naturally occurring adoption than the participant group can result in savings estimates that fall somewhere between net and gross with respect to free ridership. For example, a group of participants would be expected to be comprised of more natural adopters than a group of nonparticipants who never joined the program. These methods include:

- RED (in situations not covered by the previous list showing when RED is net)
- Matching to nonparticipants

In these cases, it is up to the evaluator to decide whether an estimate is most appropriately considered net or gross on an analysis-by-analysis basis. Some guidelines include:

- Measures where instant upstream rebates exist for a large portion of the market are likely gross as there should be very few customers who got the measure in the nonparticipant group
- Measures for income qualified customers are typically considered net as these customers are unlikely to install the measures without the incentive of the program

In some cases, evaluators may be able to implement techniques when using a nonparticipant comparison group such that the savings are sufficiently close to net and do not require further net to gross adjustment. One example of these techniques is the IV-IMR method proposed in Goldberg et. al. (2017). The UMP Chapter 21 (Violette and Rathbun, 2017) also has some discussion of getting net savings estimates using these approaches, although UMP Chapter 8 (Agnew and Goldberg 2017) should be reviewed in conjunction as it is more specific to consumption data methods. However, these techniques often require customer characteristic data that is not readily available to

⁸² Except in the case of income qualified programs where the use of future participants can produce an estimate of net savings. For specific guidance on income qualified programs see Section 3.3.1.

⁸³ See Harding and Hsiaw (2013). This is a distinct method from the UMP Chapter 8 (Agnew and Goldberg, 2017) pooled fixed effects approach which can be estimated with multiple years of participants. VIA hinges on rolling enrollment and in essence uses each participant as a control and a treatment customer through time. The Chapter 8 pooled fixed effects approach uses participants from an earlier time period as a comparison group for participants from a later time period.

⁸⁴ For details see: Goldberg, M.; Agnew, K.; Train, K.; Fowlie, M. (2017). *Mitigating Self-Selection Bias in Billing Analysis for Impact Evaluation*. Pacific Gas and Electric Company. CALMAC Study ID PGE0401.01. <http://www.calmac.org/publications/Mitigating_Self_Selection_Bias_in_Bill_Analysis_8.4.17.pdf>

⁸⁵ See Section 5.

evaluators and some of them needed to be further tested beyond theoretical simulations.

5.3.5 Consumption Data Analysis Designs with a Comparison Group

This section discusses descriptions of and considerations for estimating savings via consumption data analysis designs with a comparison group. Although the ideas of net and gross savings are touched upon, the full discussion on whether each of these methods produce net or gross savings and under what circumstances is in Section 5.3.1.

5.3.5.1 Randomized Controlled Trials

In a randomized controlled trial (RCT) design, evaluators (and sometimes implementation contractors) randomly assign sampled members of a population of interest to a treatment group or a control group. Among the benefits offered by an RCT—when properly applied—is that it produces net savings estimates by netting out free ridership.⁸⁶ The evaluation of a program must be designed and implemented this way from the outset; it is not possible for an evaluation team to apply RCT evaluation techniques after the program has been implemented if random assignment to treatment and control groups was not done before program launch. While such designs are rarely possible outside of Home Energy Report programs, one should not overlook the possibility of such designs in evaluating new pilot programs.

For some programs, evaluators must take a second step to ensure savings are not being double-counted, either counting savings being claimed by other programs or savings already credited to earlier program efforts (often called “legacy uplift”). Only net increases in participation in other programs should be considered in this uplift adjustment; changes to total savings do not need to be made based on decreases in participation in other programs.

5.3.5.2 Random Encouragement Designs

In a random encouragement design (RED), eligible customers are randomly assigned between an encouraged group (who receives incremental encouragement to join the program⁸⁷) and a non-encouraged, or control, group (who does not receive the encouragement). Members of either group can join the program, but the encouraged group is expected to do so at a higher rate.⁸⁸ If the encouragement is not effective at driving the encouraged group into the program at a higher rate than the non-encouraged group then the evaluation design breaks down and other (likely quasi-experimental) methods will be needed to estimate program savings.

In an RED, both the encouraged and non-encouraged group are made up of the following:

1. Always takers – customers who will join the program with or without the encouragement
2. Compliers – customers who only join the program if they receive the encouragement
3. Never takers – customers who will never join the program, regardless of whether they receive the encouragement

In the non-encouraged group, the always takers can be distinguished from the compliers and never takers (they’re the portion of the non-encouraged group who joins the program), but the compliers and never takers cannot be distinguished from one another (they’re both observed not to join the program). In the encouraged group, the never takers can be distinguished from the always takers and compliers (they’re the portion of the encouraged group who does not join the program), but the always takers and compliers cannot be distinguished from one another (they’re both observed to join the program).

Like RCTs, REDs are a form of experimental design. An RED is known to give an unbiased estimate of net savings

⁸⁶ RCTs eliminate free rider bias because the random assignment of customers to treatment and control groups equally distributes such participants between the two. Due to differential attrition and random chance, small differences may occur between the distributions of free riders in the two groups for any given sample. Their expected values, however, will be identical, and in any case the size of any such discrepancies shrinks as sample size increases. Thus, this is only a potential concern for programs with unusually small numbers of participants.) Upon comparing the two groups’ energy consumption, free riders’ energy savings in the control group cancel out those in the treatment group, eliminating free rider bias.

⁸⁷ The encouragement could take many forms including targeted marketing or direct monetary incentives.

⁸⁸ This design does not preclude mass marketing of the program to all customers but relies on the encouragement being effective at driving the encouraged customers into the program at a higher rate than the non-encouraged customers.

(with respect to free ridership) for the compliers. Applying this savings to the always takers group requires some explanation of why it is likely to be accurate. Additionally, the RED design provides the average net savings per participant for those who participate because of the encouragement but otherwise would not (compliers). This is not necessarily the same as the net savings for the original program without extra encouragement. In particular, we would expect free-ridership to be lower among those who need extra encouragement. Thus, the RED might be expected to overstate net savings for the original program if free-ridership is present but would still provide useful information.

There are several methods for evaluating REDs using panel data including methods using instrumental variables (IVs) and the inverse mills ratio (IMR).⁸⁹

5.3.5.3 Quasi-Experimental Designs

Where randomized assignments prove infeasible, quasi-experimental design (QED) evaluation methods can be substituted (although experimental designs are typically preferable when possible). Depending on the exact QED implemented, the savings may be net, gross, or somewhere in between with respect to the different pieces of a NTG adjustment (participant spillover, nonparticipant spillover, and free ridership). The specifics of net versus gross estimation are covered in Section 5.3.1, this subsection does not rehash this issue but rather describes estimation for a subset of QED methods.

Three quasi-experimental approaches are commonly used to evaluate behavior-based energy efficiency programs that cannot be constructed as experiments:⁹⁰

- Regression discontinuity (RD)
- Variation-in-adoption (VIA)⁹¹
- Matched controls (MC)

All three rely on a nonrandom comparison group.

Regression Discontinuity. RD requires basing a program’s eligibility on a continuous variable (e.g., customers’ adjusted gross income falling below a cutoff value for them to qualify for the program). When this is true, the RD method assumes customers just beyond the cutoff likely will be very similar, on average, to those just inside of it. The method compares changes in energy usage for a group just outside of the eligible range to that of a group of participants just on the other side of the eligibility cutoff. The RD approach, however, is susceptible to an important weakness: misspecification of the regression functional form.⁹²

Variation-in-Adoption. The VIA model applies only to program participants.⁹³ For this method, customers must sign

⁸⁹ See, for example:

Goldberg, M.; Agnew, K.; Train, K.; Fowlie, M. (2017). *Mitigating Self-Selection Bias in Billing Analysis for Impact Evaluation*. Pacific Gas and Electric Company. CALMAC Study ID PGE0401.01.

<http://www.calmac.org/publications/Mitigating_Self_Selection_Bias_in_Bill_Analysis_8.4.17.pdf>

Fowlie, M.; Greenstone, M.; Wolfram, C. (2015). *Are the Non-Monetary Costs of Energy Efficiency Investments Large? Understanding Low Take-up of a Free Energy Efficiency Program*. American Economic Review: Papers and Proceedings 105(5): 201-204. <

https://www.povertyactionlab.org/sites/default/files/publications/389_500%20Weatherization%20AER.pdf>

⁹⁰ There are many other types of QEDs that may be appropriate for evaluation, but these are some of the most commonly used for evaluation in IL.

⁹¹ See Harding and Hsiaw (2013). This is a distinct method from the UMP Chapter 8 (Agnew and Goldberg, 2017) pooled fixed effects approach which can be estimated with multiple years of participants. VIA hinges on rolling enrollment and in essence uses each participant as a control and a treatment customer through time. The Chapter 8 pooled fixed effects approach using participants from an earlier time period as a comparison group for participants from a later time period. The Chapter 8 pooled fixed effects method is discussed in Section 5.3.6.

⁹² The most common misspecifications are: mistaking a nonlinear relationship for a discontinuity; and failing to recognize potential interactions between assignments and the treatment studied. See W.R. Shadish, T.D. Cook and D.T. Campbell, *Experimental and Quasi-Experimental Designs for Generalized Causal Inference*, Wadsworth 2002, pp. 229-238.

⁹³ Harding, M. and Hsiaw, A. 2013. *Goal Setting and Energy Conservation* Available at:

http://people.duke.edu/~mch55/resources/Harding_Goals.pdf.

up for the program on a rolling basis. VIA takes advantage of its enrollees' differential timing to compare energy usage of customers opting in to that of customers not yet opting in (but doing so later). The method relies on an assumption that, in any given month, customers that soon opt in have similar characteristics to those who have enrolled, both in observable and unobservable characteristics. For this assumption to prove valid, customers must decide to opt into the program at different times for essentially random reasons (e.g., influenced only by marketing exposure and program awareness).⁹⁴ In particular, the decision to opt in should not relate to observable or unobservable household characteristics.⁹⁵

Matched Controls. MC creates a control group by matching each treatment customer to the most similar nonparticipant customer available on the basis of exogenous covariates from the pre-enrollment period known to highly correlate with post-enrollment usage.⁹⁶ The covariate most likely to correlate with post-enrollment energy usage in a given time period is customer energy usage during the same period of the preceding year, but other observable factors may be used when available. Implementing MC requires customer usage data for the year preceding all opt-in customers' decisions to participate in the program, along with a large group of nonparticipants who can be assumed to be similar to opt-in customers, aside from their program participation status. Whenever possible, the pool of potential matches should be drawn from the same geography, customer class, and rate category as the participants.

Another option is to pull the nonparticipants from a group of prior or future participants in the program (sometimes referred to as the cohort design⁹⁷). These groups are similar to current participants since we know that they also join the program at an earlier or future date, significantly mitigating the issue of self-selection bias (wherein, customers who join the program are different from those who do not in unobservable ways).⁹⁸ However, using this design can significantly decrease the number of participants for analysis and the size of the potential matching group. It can also require the evaluator to delay the analysis if more recent participants are being used as the comparison group.⁹⁹

The MC method involves identifying a nonparticipant customer whose energy usage closely matches that of a program participant in the months preceding the participant's enrollment in the program. The logic inherent in this approach is: if the analyst finds a set of nonparticipants who, on average, are the same as participants regarding energy consumption before program enrollment, these matches will provide a good counterfactual estimate of how much energy participants would have used in the program's absence.

The MC approach does present a main weakness: it can only identify matches based on observable customer characteristics, which leaves open the exclusion of the possible influence of relevant unobservable variables. While factors other than pre-enrollment energy usage plausibly could be used (e.g., household income, demographics, geographic location) in the matching process to address relevant unobservable characteristics (e.g., attitudes toward

⁹⁴ This differs from an RCT with a recruit-and-delay design, in which customers do not choose when to opt in, but instead are randomly assigned different times to opt in, and from an RCT with a recruit-and-deny design, where customers are randomly denied access to the program.

⁹⁵ As the validity of the VIA method depends on this assumption, it should be empirically tested to the extent possible. If program marketing is punctuated and dates of marketing exposure are known, it is possible to test whether household enrollment in any particular month is driven by marketing activity, as opposed to observed household characteristics or unobserved heterogeneity. A test of whether the energy usage of households before they opt in differs from households that opt in during any particular month as opposed to another month is built into the VIA regression model's functional form. See Harding and Hsiaw, *op. cit.*, for details.

⁹⁶ See Daniel E. Ho, Kosuke Imai, Gary King, and Elizabeth Stuart, 2007, "Matching as Nonparametric Preprocessing for Reducing Model Dependence in Parametric Causal Inference." *Political Analysis* 15(3): 199-236.

⁹⁷ See W.R. Shadish, T.D. Cook and D.T. Campbell. (2002). *Experimental and Quasi-Experimental Designs for Generalized Causal Inference*. New York: Houghton Mifflin Company, pp. 148-153

⁹⁸ Though there could still be a selection issue based on when customers choose to join the program. As with VIA, the assumption is that the timing of participation is basically random.

⁹⁹ The cohort design has also been used, under certain conditions, to control for exogenous factors when estimating gross savings. See Agnew, K. and M. Goldberg. (2017). Whole Building Retrofit with Consumption Data Analysis Evaluation Protocol: Chapter 8 of the Uniform Methods Project, National Renewable Energy Laboratory.

energy conservation and environmental concerns), this assumption cannot be directly tested.¹⁰⁰

There is a special case of MC called propensity-score matching. This develops a binary choice (logistic regression) model to predict the probability that a customer will opt into the program, and then, for a comparison group. The logistic regression reduces each household's set of covariates to a single propensity score. Nonparticipants are then matched to participants based on their propensity scores. This functions well if observable variables used to calculate the propensity score sufficiently correlate with relevant unobservable variables to explain differences between treatment and control customers that cannot be explained by matching on observable variables. With most evaluations of energy efficiency programs, however, little (if any) data are available on nonparticipating customers other than their energy usage. In some cases, the demographic data necessary to estimate these models can be obtained from providers such as Experian and assigned to each participant and nonparticipant.

Self-Selection Bias and QED. Self-selection bias due to observable and unobservable variables is always a possibility with QEDs. One can collect as much information as possible on both participants and members of the comparison group and include them as covariates in the regression model, but there may still be self-selection bias related to unobservable variables. Several techniques have been developed to help mitigate it. Efforts to address the biasing effects of *unobserved* differences using Inverse Mills Ratios began at least as early as the late 1980s. Since then, Train (1993) and Goldberg and Train (1995), using simulated datasets, demonstrated that failing to correct for self-selection can overestimate net savings, but that there are effective strategies to reduce this bias substantially.

One approach is to calculate and enter the propensity score, based on observable variables, as an additional covariate into the regression model. Of course, the most difficult issue to address is the differences between participants and nonparticipants that are unobserved and unobservable. To mitigate both overt and hidden bias, a variety of approaches that attempt to take advantage of recent developments in statistics and econometrics are available:

- Sample selection models (e.g., Heckman's two-step estimator (1978, 1979); treatment effect model (Green, 2003); instrumental variables estimator (Wooldridge, 2002)
- The propensity score matching model (Rosenbaum and Rubin, 1983, 1985; Hansen and Klopfer, 2006; Guo and Fraser, 2014)¹⁰¹
- Matching estimators and synthetic controls (Abadie and Imbens, 2002, 2006)
- Instrumental variables approach with the predicted probability of participation serving as the instrumental variable and the inclusion of an Inverse Mills Ratio (IMR) (Goldberg et al., 2017)

Another issue that should be considered is that, when using a comparison group in a QED, the composition of the comparison group needs to be carefully considered.^{102,103} For example, simply selecting a random sample of nonparticipants from the general nonparticipant population could result in an estimate of savings that is somewhere between net and gross, thus overestimating net savings. For a single-measure residential program like an air conditioner (AC) replacement program, the eligible population is the population of customers who have purchased a new air conditioner. That is, part of the eligible population appropriate to a net effects comparison group would be those who purchased and installed some air conditioner, whether efficient or not. Simply selecting from the general residential population would include households with no air conditioner, those with older ACs of varying vintages, those with new standard efficient ACs and those with new program-qualified ACs. The results would be virtually uninterpretable. Of course, for more complex multi-measure programs, finding the appropriate comparison group is far more challenging.

¹⁰⁰ Such secondary, observable characteristics are rarely available to evaluators of energy efficiency programs, except for geographic location (e.g., postal zone of customer premise).

¹⁰¹ Note that propensity scores cannot remove hidden biases except to the extent that unmeasured variables are correlated with the measured covariates used to compute the propensity score

¹⁰² See Agnew et al., Section 8.1.3 (The Importance of Measures Applicability)

¹⁰³ Katherine Randazzo, Richard Ridge and Seth Wayland. Evaluating Whole-Building Programs: It is harder and easier than you think! Presented at the International Energy Program Evaluation Conference in August 2017.

5.3.6 Consumption Data Analysis Designs without a Comparison Group

Although less common, consumption data methods can also be used to estimate savings without the use of a comparison group. These methods typically estimate gross savings, and net savings are found by multiplying gross savings by a separately estimated NTGR. There are basically two types of pre/post models to estimate gross savings:

- the pooled participant-only linear fixed-effects approach
- site-specific regression models

In both modeling approaches, exogenous factors must be controlled for.¹⁰⁴

Pooled Approach. The pooled approach addresses exogenous change without the inclusion of a separate comparison group. In this model, participants who received a measure installation during a certain time interval serve as a steady-state comparison for other participants in each other time interval. Almost all observation points include premises that are still in their pre-installation period and premises that are in their post-installation period, so the effect of post- versus pre- is estimated to control for exogenous trends. Note that if changes at the site that affect energy use are not or cannot be explicitly modelled the estimated gross savings will be biased. This method is typically used in analysis of residential and small (and occasionally for large) commercial programs.

Site Specific Regression Models. This approach involves the estimation of site-specific regression models to estimate savings. This method is often used for large commercial and industrial customers or in other situations where it is difficult to identify an adequate comparison group (for example, in evaluation of Strategic Energy Management programs). In these cases, single customer regressions are typically run as a time series without a cross-section of customers.

Note that both the pooled approach and the site-specific approach and the conditions that must be met before using them are discussed in Agnew and Goldberg (2017).

5.3.7 Program Implementation and Consumption Data Analysis

The approach the evaluation can use to estimate net savings is greatly dependent on the design of the program and the size of the expected savings (i.e., the signal-to-noise ratio).

RCT and RED: These designs must be integral to a program's implementation. Without the ability to randomly assign customers to the control and treatment groups (or at least randomly encourage customers to participate in a program), the ability of the design to yield unambiguous estimates of net impacts is compromised. Evaluators often help design how a program is implemented. However, if they not involved at the outset, they cannot carefully review choices made by the implementation team. RCT and RED designs are difficult to perform well within the commercial and industrial sectors due to a low signal-to-noise ratio. One solution for these two sectors is to increase the sample size but this is not always feasible.

QED: A QED may be designed after a program has been implemented. It relies on determination of an equivalent comparison group, which is often chosen based on energy use and other variables, if available. QED is also difficult to perform well within the commercial and industrial sectors due to a low signal-to-noise ratio. One solution for these two sectors is to increase the sample size but this is not always feasible.¹⁰⁵

Methods without a Comparison Group: These methods can also be implemented by the evaluator after the program has been designed. They are most appropriate in situations where it is difficult to construct an appropriate comparison group.

For any kind of evaluation design, evaluators may also analyze the data to help understand the savings within specific segments if sufficient information and data points are available.

¹⁰⁴ Exogenous factors include non-program-related effects due to the economy and other factors affecting energy consumption.

¹⁰⁵ A power analysis can be undertaken before the actual analysis to determine whether the sample size available is likely to be large enough to produce statistically significant savings at the desired confidence level.

References

- Abadie, Imbens, 2002, 2006
- Agnew, Goldberg, 2017
- Donaldson, 2009
- Fowlie, Greenstone, Wolfram, 2015
- Goldberg, Agnew, Train, Fowlie, 2017
- Goldberg, Train, 1995
- Green, 2003
- Guo, Fraser, 2014
- Hansen, Klopfer, 2006
- Harding, Hsiaw, 2013
- Heckman, 1978, 1979
- Ho, Imai, King, Stuart, 2007
- Mohr, 1995
- Shadish, Cook, Campbell, 2002
- Scriven, 2008
- Randazzo, Ridge, Wayland, 2017
- Rosenbaum, Rubin, 1983, 1985
- Train, 1993
- Wooldridge, 2002

5.4 Midstream Free-Ridership Protocol¹⁰⁶

Typical energy efficiency programs offer incentives to end-use customers to purchase more efficient equipment. These can be referred to as “downstream” incentives, or downstream programs. Moving up the supply chain, the next entities are distributors, contractors, and design professionals. Programs aimed at influencing these market actors are referred to as “midstream” programs. “Upstream” programs target manufacturers and potentially retailers.

5.4.1 Using This Protocol

The methods described in this section should be applied for estimating NTGRs for midstream programs in which the incentives are paid directly to distributors who have the option of sharing some or all of these incentives with the end-use customers in the form of price reductions. As discussed in further detail later in this section, programs of this type influence behavior of distributors, end-users, and intermediaries such as contractors, installers, or design professionals(to various degrees).¹⁰⁷

As a result, in midstream programs where it is believed that multiple parties are aware of the utility intervention, it is desirable for evaluators to conduct research that produces multiple estimates of free ridership from different perspectives, and to combine these estimates using guidance provided in Section 5.1: Combining Participant and Trade Ally Free Ridership Scores to estimate a NTGR that is inclusive of multiple perspectives.¹⁰⁸

¹⁰⁶ Note that the method for assessing trade ally spillover is included in Section 5.2.

¹⁰⁷ Note that the Illinois TRM does not currently prescribe a specific method for assessing free ridership from a trade ally perspective. Consistent with Section **Error! Reference source not found.**, until such a prescribed methodology becomes available, evaluators should coordinate on survey design and calculation algorithms for trade ally free-ridership estimation.

¹⁰⁸ In cases where midstream programs require distributors to pass the entire incentive to a customer and collect customer information, it is still likely that the program is affecting distributor behavior, and distributor research is still valuable.

In these cases, care should be taken to design an evaluation approach that most appropriately reflects the theory of program influence and selects perspectives to research free-ridership from commensurate with program theory. For example, in many midstream HVAC program models, intermediaries (contractors/installers) have an influential role in the sales process with end-use customers, and to the extent that program design attempts to influence intermediary behavior as well as distributor and end-user behavior, research with these actors may be appropriate. Conversely, in other midstream program models, intermediaries may not be a target for program activity and/or may not play an influential role in the sales process, in which case research with these actors would not be appropriate.

All midstream programs should collect contact information for participating distributors and make it available to evaluators. Midstream programs may or may not collect information for other actors such as end-use customers and/or intermediaries. In cases where midstream programs do not collect customer information, end-user research will generally not be feasible, and free ridership estimates will not be able to include an end-user perspective on free-ridership. In cases where midstream programs do not collect intermediary information, intermediary research may still be feasible, but will require care in order to define an appropriate sample that accurately represents the pool of intermediaries relevant to the program. For example, some midstream programs may not track installing contractors but may maintain a list of qualified program allies who would be expected to complete a significant share of installations receiving program incentives.

If evaluation constraints do not allow for high quality research to be conducted from multiple perspectives, it is likely preferable to conduct high quality research from only one perspective rather than lower quality (e.g., minimal sample size) research from multiple perspectives, and the evaluator may choose to utilize only one approach without it being considered a divergence from the IL-NTG Methods. In this case, the evaluator should carefully consider the specific design and intent of a given program when choosing the appropriate protocol(s) for evaluation and must document the rationale for its decision in the evaluation plan.

Ultimately, the protocol(s) to be used for a given program is defined in Table 3-1 and Table 4-1. If the design of a given program changes significantly, then it may mean that the NTG protocol listed for that program in Table 3-1 or Table 4-1 is no longer appropriate. In addition, the evaluator may determine that the defined customer or distributor NTG algorithms need to be substantially modified to accommodate the specific design of a midstream program. If the evaluator chooses to use an alternative method or approach to estimate the NTG, the evaluator should follow the procedures outlined in Section 1.4: Diverging from the IL-NTG Methods. For new programs the choice of protocol(s) will be ultimately at the discretion of the evaluator.

Knowing that they will receive an incentive for selling high efficiency units, distributors may choose to increase their stock of high efficiency units, and/or to upsell high efficiency units to contractors. Distributors may also choose to offer training sessions or marketing campaigns aimed at engineers, architects, and contractors to increase awareness of these high efficiency units. As a result of the program's actions:

Contractors/customers may be more likely to purchase high efficiency units because they are in stock,

Contractors/customers may be more likely to purchase high efficiency equipment because the distributor upsold these units,

Contractors/customers may be more likely to purchase high efficiency units because the incremental cost is lower than it would have been without the incentive (assuming the distributor uses the incentive to reduce the price of the equipment), and

Design professionals and contractors may be more likely to specify or recommend high efficiency units because they are more aware or more familiar with these options.

The expected overall outcome is that a greater proportion of customer purchases will be high efficiency units. As distributors sell more high efficiency units, manufacturers will respond by producing more high efficiency equipment. Ultimately, the overall market in a utility's service territory will become more efficient than it otherwise would have been, or it will achieve this efficiency sooner than if no intervention had occurred.

To assess impacts from this type of program, the evaluator needs to determine if the distributor changed their practices in a way that ultimately influenced the customer's buying decision. Assessing the influence of the program

involves conducting in-depth interviews with participating distributors and asking them how they would have behaved in the absence of the program. While interviews with others such as contractors and design professionals can also be conducted in order to develop a more complete understanding of the influence of the program, the focus of the protocol in Section 5.4.2 below is on the distributor interviews.

This protocol is based on the key considerations and guidelines for estimation of free ridership for non-residential programs that is described in Section 3.1.1: Core Non-Residential Free Ridership Protocol. The process to be used for scoring free ridership is described in Section 3.1.1.1: Core Non-Residential Free Ridership Scoring Algorithm. This midstream protocol can be used for estimating NTGRs for both residential and non-residential midstream programs that focus on distributors.¹⁰⁹

To ensure that the midstream NTGR approach covers all avenues of program influence, one should develop a logic model based on discussions with utility program staff, implementer staff, and a general review of midstream programs. The midstream NTGR approach recommended here is designed to be flexible as the midstream incentives may be impacting distributors' businesses in one of many ways—including via changes in stocking, upselling, price reduction, etc. Ultimately, the midstream program should be given credit for influence via any of these causal pathways. Note that a midstream program might have longer-term impacts that are not immediately measurable. Such longer-term impacts manifest as "market effects," which signify a transformation in the underlying structure and functioning of the market. This midstream protocol does not address the measurement of such market effects.

5.4.2 Free Ridership Estimation Methodology

This methodology uses two indicators of free ridership:

- Program Influence (PI) FR Score, and
- Counterfactual (CF) FR Score

These scores are then averaged to arrive at a final free ridership value. The algorithm shown in Section 3, Figure 3-1: Core Free Ridership Algorithm, can be used to calculate the free-ridership. The resulting NTGR value should be weighted proportionate to the ex post gross kWh savings for each respondent.

The one exception to the free ridership algorithm described above concerns the quantity and timing adjustment. Note that normally, in the case of downstream rebate programs, it is possible that the old equipment was still functioning, but the program induced the participant to swap out the equipment before the end of its useful life. Because of the conceptually challenging nature of a timing question for distributors, it has been removed.

This protocol starts with the Core Non-Residential Protocol methodology outlined in Section 3, Figure 3-1: Core Free Ridership Algorithm and suggests modifications to the free ridership questions to recognize the unique nature of midstream programs. Below are some examples of the types of questions that could be asked of distributors for each of the three pathways to program influence.

5.4.2.1 Strategies Used

First, the evaluator must ask each distributor which of the available sales strategies they used to promote program-qualified equipment.

Now, I'm going to ask you about the various strategies you might have used to sell program-qualified equipment. Please indicate which ones you have used. [READ]

- Upsell contractors to purchase program-qualified units
- Conduct training workshops for contractors
- Increase marketing of program-qualified units
- Reduce the prices of program-qualified units

¹⁰⁹ See Section 4.3 for a description of an approach for calculating NTG specifically for Residential Upstream Lighting programs.

- ___ Increase the stocking or assortment of program-qualified units
- ___ Discuss the benefits of program-qualified units with design professionals
- ___ Other (Please describe: _____)

Program Influence FR Score

The PI Score measures the overall influence of the program on the distributor’s efforts to sell more energy efficient equipment instead of a less efficient alternative. It is developed based on a single question that asks the respondent to rate the overall importance of the program on the decision to install energy efficient equipment using a scale from 0 to 10, with 0 being not at all important and 10 being extremely important.

As described in Section 3.1, to ensure the respondent thinks about the program holistically, before asking the single question, the survey will remind the respondent of various program factors that might have influenced decision-making. This could either be through one or more questions about various program factors, or through a read-in of program factors.

Program factors are those utility actions designed to convince the distributor to increase their stock of efficient equipment and to change their sales strategies in order to sell more of these more energy efficient models. These might include such things as the incentive, information about the cost-effectiveness of the more efficient units, promotional materials, and the training of sales staff. The various program factors referenced in the survey will be determined by evaluators based on available information.

Evaluators will calculate the PI Score for each survey respondent using the following equation:

$$Program\ Influence\ FR\ Score = 1 - \left(\frac{[Influence\ Rating]}{10} \right).$$

This score can range from 0 (no free ridership) to 1 (full free rider).

Counterfactual FR Score

The CF Score is based on the most likely action the distributor would have taken with respect to sales strategies for program-qualified equipment in the absence of the program.

Evaluators will administer a counterfactual likelihood survey question, which asks the respondent to identify which alternative among a list they would have been most likely to choose if the program and rebate had not been available. The scenarios will be specific to the program, but generally include options such as using fewer sales strategies to sell program-qualified equipment or using the same sales strategies as they did through the program. The respondents will be asked a follow-up question as illustrated in Figure 3-1.

In cases where the response to the initial scenario question indicates likely free-ridership, evaluators will ask a follow-up question that obtains the likelihood on a 0 to 10-point numeric scale (where 0 means “not at all likely” and 10 means “extremely likely”), absent the program, that the respondent would not have used the same sales strategies as they did through the program.

In cases where the response to the initial scenario question indicates likely non-free-ridership (flagged as “initial presumption of FR = 0” in Figure 3-1), evaluators will ask a follow-up question that obtains the likelihood on a 0 to 10-point numeric scale (where 0 means “not at all likely” and 10 means “extremely likely”), absent the program, that the respondent would have used the same sales strategies as they did through the program.

There are two options for calculating the CF Score based on the above questions.

Option 1 is the default choice and should be implemented except in cases as defined in Option 2 below. In Option 1, evaluators will calculate the CF Score for each survey respondent based on responses to the likelihood follow-up questions using one of the following equations, with the selection of the equation based on the initial scenario selected by the respondent:

$$CF\ Score = Likelihood\ would\ not\ have\ used\ same\ sales\ strategies = 1 - \left(\frac{[Rating]}{10} \right)$$

OR

$$\text{Likelihood would have used same sales strategies} = \left(\frac{[\text{Rating}]}{10} \right).$$

Option 2 is an alternative option to be used only in cases where evaluators believe that there is evidence that respondents are not able to understand and correctly answer the likelihood follow-up questions. In Option 2, evaluators will set the CF Score equal to a presumption of FR based on the initial response to the scenario question only. Figure 3-1 provides prescribes initial presumption of FR values for default scenarios. These values are binary and take the form of either no free ridership (CF Score = 0) or total free ridership (CF Score = 1).

If evaluators choose Option 2, they should still report Option 1 scores and provide a rationale for why they believe Option 1 is not appropriate based on available data. Option 2 scores do not need to be reported if Option 1 is chosen, but evaluators may wish to report the scores to enable future dialog in the NTG Working Group as to the form of the Core Non-Residential Free Ridership Protocol.

Both options for calculating the CF Score produce scores that can range from 0 (no free ridership) to 1 (full free rider). Option 2 will lead to CF Score values that are *only* 0 (no free ridership) or 1 (full free ridership).

Note that evaluators may determine that the development of the Counterfactual FR Score for Midstream programs cannot be implemented in the same manner as described above due to distributors considering multiple components with different decision-making. In these cases, evaluators may need to deviate from the Midstream Free-Ridership Protocol. This issue will be addressed in IL-TRM V13.0.

Program Factors, Consistency Checks, and Quality Control Review

Evaluators should also follow the guidelines regarding program and non-program factors, consistency checks, and quality control review in Section 3.1.1: Core Non-Residential Free Ridership Protocol.

Consistency checks, specifically, should be included consistent with guidance in Section 0. Additional consistency check questions to resolve identified inconsistencies remain optional, but may be used by the evaluator to resolve inconsistencies in real time if desirable.

Alternative Approaches to Estimation of Midstream Influence

The approach for assessing program impacts described in this section should not be considered exclusive or exhaustive. However, use of a different method or of a modified algorithm will be considered a deviation as discussed in Section 1.4: Diverging from the IL-NTG Methods, and will require a proposal to the Illinois SAG and approval of the proposed method by the SAG. Some additional potential methods that would be considered a deviation from this protocol will now be discussed. Within the general framework of the non-residential algorithm, there are other possible ways to construct indicators of free ridership depending on the data available. For example, for the No-Program FR Score, if the evaluator can obtain historic and current category sales data from each participating distributor, these data can be combined with program sales data (that they are required to provide to the utility) to determine the shift in efficient market shares at the distributor and program levels. If current category sales data are not available, the evaluator could ask the distributors about changes in these shares from the pre- to the post-participation periods (see example from EMI, 2018), although this approach is likely less reliable than shares based on recorded sales data. Or, one could also conduct an interrupted time-series analysis of monthly sales of program-qualified units. There may also be qualitative methodologies which can be combined with quantitative methodologies to enhance the accuracy of program impact estimates. One could also employ a theory-driven evaluation framework (Coryn, 2011) within which an evaluator could assess the program's effectiveness, guided by the program theory and logic model. For a complex midstream distributor program, an evaluator could develop performance metrics for each activity, output, and outcome and assess the extent to which major activities of the program have been and are being successfully implemented and whether these activities had led to or are likely to lead eventually to the expected short-, mid-, and long-term outcomes. Of course, as evaluators choose to use some of these other methods, they must propose and defend a modified algorithm that can include the results from using these other methods.

6 Appendix A: Overview of NTG Methods

The evaluation teams present information in this appendix to provide a relatively quick overview of NTG methods for readers unaccustomed to the possible methods that evaluators may deploy. It is not meant to be a complete or deep discussion about each of the methods presented. However, the evaluators in Illinois considered the inclusion of this appendix to be very important in acknowledging the current suite of methods deployed by evaluators throughout the U.S. and giving a framework for work within Illinois.

Much of the information shown below is taken directly from a single source—the national Uniform Methods Project, Chapter 23: Estimating Net Savings: Common Practices. (Violette and Rathbun, 2014) This document has done a nice job of summarizing the eight most common attribution methods currently in use across the U.S. The evaluation teams recommend that readers go first to this reference for further information. Additionally, while there are slightly over 100 references within the Violette and Rathbun document, other non-duplicative references are included where reasonable as additional resources for those interested in further research into any specific method.

6.1 Survey-Based Approaches

Virtually all Illinois based evaluations use a survey-based approach for programs where primary data is used to determine net savings. (The main exception is for behavioral programs which use statistical analysis based on a randomized control trial program design.) Survey-based approaches obtain data from program participants and nonparticipants using a structured data collection instrument implemented via phone, in person, or online.¹¹⁰ At times, evaluators create and use an unstructured depth-interview guide to collect information about attribution, and this provides both contextual data and quantitative data about a given project.

6.1.1 Self-Report Approach

The self-report approach relies on the abilities of customers to discuss the program influence as well as the somewhat abstract ideas of the counterfactual (i.e., what would have occurred absent the program) after making a choice to purchase an energy efficient item or take an energy efficient action unrelated to a purchase. For program participants, this could include doing nothing (i.e., leaving the existing equipment as-is), installing the same energy efficient equipment as they did through the program, or an intermediate step of installing equipment that is more efficient than what they had in place previously, but less efficient than what they installed through the program. Evaluators also use this approach when collecting information from trade allies or distributors. This self-report approach is not new, nor is it exclusively used by the energy efficiency industry. An important attribute of this approach is its reliance on well-designed and fielded survey questions; so that the data underlying subsequent analyses are accurate and complete.

The output of this approach is a NTG ratio which can be considered an index of the program's influence on the decision to install energy-efficient equipment. The NTG ratio is applied to gross savings in order to obtain an estimate of net savings. The NTG ratio may include free ridership, spillover, or market effects, depending on the survey and analytical design. NTG ratios may be calculated at the measure, suite of measures, or program level and are typically average values weighted by savings. If sufficient information is available, analysis of NTG ratios among certain customer segments may be done to further inform changes to program design.

References

- Sudman, 1996
- Stone, et al., 2000
- Bradburn, et al., 2004

¹¹⁰ Historically, evaluators in Illinois have collected the majority of primary data via telephone surveys. As evaluations increasingly leverage online surveys to collect information relevant to attribution, careful attention should be paid to mode effects that are due to interviewer-administered versus self-administered surveys (e.g., scale direction effects). It is recommended that evaluators, where possible, assess the differences between telephone and online survey methods for the purposes of future updates to these protocols.

6.1.2 Econometric/Revealed Preference Approach

The econometric/revealed preference approach, while still considered a survey approach due to how data is collected, moves beyond asking people about the counterfactual and instead uses the observations of the evaluator to collect information for analysis of a NTG ratio. Within this approach, evaluators typically deploy similar sampling designs as for the self-report approach to collect data, but actively gather what a person is doing (i.e., what is being purchased in a store) to determine attribution.

6.2 NTG with Consumption Data Analysis

As mentioned in Section 5.3, evaluators use randomized control trials (RCTs), random encouragement designs (REDs), and quasi-experimental designs (QEDs) using consumption data (like monthly bills or AMI meter reads) to estimate savings for a variety of programs. RCTs estimate net savings by design but other consumption data analysis methods may be net, gross, or somewhere in between. In some cases, evaluators may be able to use methods that produce estimates that are acceptably close to net without further adjustment, while in other cases a NTGR may need to be developed outside the consumption data analysis and then multiplied by the estimate to produce net savings. Therefore, the NTG adjustment method will differ and needs to be justified by the evaluator on a case by case basis.

6.3 Deemed or Stipulated NTG Ratios

A deemed (or stipulated) NTG ratio is a value known prior to implementing a program and applied to estimate net savings for that program in a certain year.

Deemed or stipulated NTG ratios may be based on previous primary data collection, a review of secondary data, or agreed to among stakeholders. In Illinois, deemed or stipulated NTG ratios should reflect best estimates of likely future actual NTG ratios for the relevant program year, taking into consideration stakeholder input, the evaluator's expertise, and the best and most up-to-date information.

6.4 Common Practice Baseline Approaches

For this method, the evaluation team estimates what a typical consumer would have done at the time of the project implementation. Essentially, what is "commonly done" becomes the basis for baseline energy consumption and calculation of net savings. No gross impacts are calculated in this approach. This baseline is defined as the counterfactual "i.e., what would have occurred absent the program" and has been referred to as current practice, common practice, or industry standard practice. Evaluators determine these practices through multiple methods, but often can be from self-report or on-site audits. The difference between the energy use of measures installed in the program and the energy use associated with current practice is considered by some to be sufficiently close to the net savings.

This approach is not in use in Illinois, but it is used elsewhere in the country, such as the Pacific Northwest and Delaware.

6.5 Market Analyses

Market analyses can be done in several ways. Market analyses are often used in theory-driven evaluations of market transformation programs.

Other non-sales data market analyses can be postulated on changes specified in program logic such as: 1) changes in the number of energy-efficient units manufactured; 2) changes in market actor behavior around promotion or stocking of energy-efficient items; or 3) reductions in prices. The analyses involving non-sales data must make a clear link between the program intervention and the changes found in the market. Additionally, outside of Illinois, while evaluators have extrapolated the market changes to specific energy or demand reductions, this activity may be viewed as tenuous due to assumptions that evaluators must make within the analysis.

Illinois is in a position to begin to discuss market analyses and how specific research may be able to interpret changes that have occurred (or may occur in the future) because of the program interventions over the past eight years.

Market analyses can be backward looking through historical tracing, but it is best used when the logic of an intervention is described, and specific market metrics are tracked over time.

6.6 Structured Expert Judgment Approaches

Closely tied to market analysis, this approach is a way for evaluators to gather credible evidence of changes that arise due to the intervention of a program. When deployed, it is often used as a cost-effective approach to estimate market effects or reach agreement on a NTG value when several different types of evidence are available. The key premise of this approach is the use of a select group of known experts that all stakeholders agree can provide unbiased information as well as having sufficient knowledge to judge what may have occurred absent a program intervention.

A Delphi Panel is an example of this approach where data are collected from two or more rounds of data collection (which can occur via e-mail, Internet, or in person). A round is when experts make their thoughts known about a specific subject; the evaluation team synthesizes the data and provides this collated data back to the group to discuss again. Allowing the full experts to see how their peers think about a topic helps to move the group towards consensus.

References

- Mosenthal, et al., 2000
- Powell, 2002

6.7 Program Theory-Driven Approach

This approach is not included in the Violette and Rathbun (2017) document as a high-level method, but it is discussed by the authors under the historical tracing method. The Illinois evaluators believe that it deserves at least a short discussion within this framework.

A program theory is the written narrative about why the activities of a program are expected to bring about change. Typically associated with this approach is the direct graphical explication of the linkages between activities, outputs, and outcomes through an impact logic model.¹¹¹

A theory-driven evaluation denotes “[A]ny evaluation strategy or approach that explicitly integrates and uses stakeholder, social science, some combination of, or other types of theories in conceptualizing, designing, conducting, interpreting, and applying an evaluation.” (Coryn 2011) Within this approach, the ultimate conclusions regarding the efficacy of a program are based on the preponderance of the evidence and not on the results of any single analysis. Coryn and colleagues systematically examined 45 cases of theory-driven evaluations published over a 20-year period to ascertain how closely theory-driven evaluation practices comport with the key tenants of theory-driven evaluation as described and prescribed by prominent theoretical writers. One output from this analysis was the identification of the core principles and sub-principles of theory-driven evaluation. If interested, please review the reference under Coryn 2011.

As an approach, it is best used for complex programs and/or causal mechanisms that extend far into the future. Evaluators collect evidence that supports or rejects hypotheses that are explicit in the logic model. The case for program attribution is strengthened based on the extent to which an evaluation shows that the expected changes occur. Additionally, the evaluation team may be able to collect data that will answer questions about the longer-term outcomes of a program. This type of data collection may be very similar to market tracking activities described briefly above under Market Analyses.

This approach does not specifically estimate a NTG value, but Program Administrators can choose to keep, drop, or change a program based on intermediary data. Regulators must be convinced that the logic of a program is sound and that the intermediary outcomes are causally linked to expected savings.

¹¹¹ Evaluators may use logic models to show program processes as well, but this is a program flow chart, not an impact model.

References

- Weiss, 1997
- Chen, 2000
- Coryn, 2011

6.8 Case Studies Design

Case studies are used extensively in social sciences as well as many other disciplines or practice-oriented areas, such as political science, economics, education, and public policy. Case studies help to understand the how and why of a situation and typically retain a holistic aspect of real-life events. As such, they may be a useful approach to determine attribution. As with program theory design, though, the data collected and analyzed within a case study approach will not typically yield a specific NTG value, but can provide credible evidence and insight that supports or refutes the changes brought about by program intervention.

To be used to assess attribution, evaluators must carefully design case studies to assure they account for the threats to causality (i.e., internal validity) that arise in any design. While not typically thought of in this manner, case study design can address multiple types of validity such as construct, internal, and external validity as well as assuring reliability. When establishing construct validity and reliability, evaluators must use multiple sources of evidence, create and maintain a study database, and maintain a “chain of evidence” within the analysis. Internal validity is shown through analytic tactics such as pattern matching, explanation building, addressing rival explanations, or using logic models. External validity centers on the ability to generalize the analytical findings to other similar situations. External validity may be shown through the replication of findings.

References

- Yin, 2003
- Stake, 2006

7 Appendix B: References

- Abadie, A. and G. W. Imbens. (2002). Simple and bias-corrected matching estimators [Technical Report]. Department of Economics, University of California, Berkeley. Retrieved March 6, 2016, from <http://ideas.repec.org/p/nbr/nberte/0283.html>.
- Abadie, A. and G. W. Imbens. (2006). Large sample properties of matching estimators for average treatment effects. *Econometrica*, 74, pp. 235-267.
- Agnew, K. and M. Goldberg. (2017). Whole Building Retrofit with Consumption Data Analysis Evaluation Protocol: Chapter 8 of the Uniform Methods Project, National Renewable Energy Laboratory.
- Bradburn, Norman, Sudman, Seymore, and Wansink, Brian. 2004. Asking Questions. The Definitive Guide to Questionnaire Design – For Market Research, Political Polls, and Social and Health Questionnaires. San Francisco, CA: Jossey-Bass.
- Chen, Huey-Tsyh. 1990. Theory-Driven Evaluations. Sage Publications.
- Coryn, Chris L.S., Norakes, Linday A., Westine, Carl D., Schröter, Daniela C. 2011. “A Systematic Review of Theory-Driven Evaluation Practice from 1990 to 2009.” *American Journal of Evaluation*, 32(2): 199-226.
- Donaldson, Steward I., Christie, Christina A., Mark, Melvin M. 2009. What Counts as Credible Evidence in Applied Research and Evaluation Practice? Los Angeles, CA: Sage Publications, Inc.
- EMI Consulting. (2018). Xcel Energy: Colorado Cooling Efficiency Product: 2017 Evaluation. Prepared for Xcel Energy.
- Fowlie, M.; Greenstone, M.; Wolfram, C. (2015). Are the Non-Monetary Costs of Energy Efficiency Investments Large? Understanding Low Take-up of a Free Energy Efficiency Program. *American Economic Review: Papers and Proceedings* 105(5): 201-204. <
https://www.povertyactionlab.org/sites/default/files/publications/389_500%20Weatherization%20AER.pdf>
- Greene, W. H. (2003) *Econometric Analysis* (5th Ed.). Upper Saddle River, N.J.: Prentice Hall.
- Goldberg, M. L. And K. Train, (1995) Net Savings Estimation: An Analysis of Regression and Discrete Choice Approaches. Submitted by Xenergy Inc. To CADMAC Subcommittee on Base Efficiency.
- Goldberg, M.; Agnew, K.; Train, K.; Fowlie, M. (2017). Mitigating Self-Selection Bias in Billing Analysis for Impact Evaluation. Pacific Gas and Electric Company. CALMAC Study ID PGE0401.01. <
http://www.calmac.org/publications/Mitigating_Self_Selection_Bias_in_Bill_Analysis_8.4.17.pdf>
- Gou, Shenyang and Mark W. Fraser, (2015). Propensity Score Analysis: Statistical Methods and Applications. Los Angeles, CA: SAGE Publications.
- Hansen, B. B. and S. O. Klopfer. (2006). Optimal Full Matching and Related Designs via Network Flows. *Journal of Computational and Graphical Statistics*, 15, pp. 1-19.
- Harding, M. and Hsiaw, A. 2013. Goal Setting and Energy Conservation Available at: http://people.duke.edu/~mch55/resources/Harding_Goals.pdf.
- Heckman, J. J. (1979). Sample Selection Bias as a Specification Error. *Econometrica*, 47(1), pp. 153-162.
- Heckman, J. J. (1978). Dummy Endogenous Variables in a Simultaneous equations system. *Econometrica*, 46(1), pp. 931-960.
- Ho, D.E., Imai, K., King, G. and Stuart, E., 2007. “Matching as Nonparametric Preprocessing for Reducing Model Dependence in Parametric Causal Inference.” *Political Analysis* 15(3): 199-236.
- Mohr, Lawrence B. 1995. *Impact Analysis for Program Evaluation*, Second Edition. Thousand Oaks, CA: Sage Publications, Inc.
- Mosenthal, Philip, Pahl, Ralph, Neme, Chris, and Cuomo, Robert. 2000. A Modified Delphi Approach to Predict Market Transformation Program Effects. Proceedings from the 2000 ACEEE Conference.

Powell, Catherine. 2002. "The Delphi Technique: Myths and Realities." *Journal of Advanced Nursing*. 41(4), 376-382.

Randazzo, K., Ridge, R. and Wayland, S. Evaluating Whole-Building Programs: It is harder and easier than you think! Presented at the International Energy Program Evaluation Conference in August 2017.

Rosenbaum, P. R. and D. B. Rubin. (1983). The central role of the propensity score in observational studies for causal effects. *Biometrika*, 70, pp. 41-55. 21

Rosenbaum, P. R. and D. B. Rubin. (1985). Constructing a control group using multivariate matched sampling methods that incorporate the propensity score. *American Statistician*, 39, pp. 33-38.

Scriven, Michael. "A Summative Evaluation of RCT Methodology and an Alternative Approach to Causal Research." March 2008. *Journal of MultiDisciplinary Evaluation*, Volume 5, Number 9. ISSN 1556-8180.

Shadish, William R., Cook, Thomas D., and Campbell, Donald T. 2002. *Experimental and Quasi-Experimental Designs for Generalized Causal Inference*. Boston: Houghton Mifflin Company.

Stake, Robert E. 2006. *Multiple Case Study Analysis*. The Guilford Press.

Stone, Arthur A., Turkkan, Jaylan S., Bachrach, Christine A., Jobe, Jared B., Kurtzman, Howard S., Cain, Virginia S. editors. 2000. *The Science of Self-Report. Implications for Research and Practice*. Lawrence Erlbaum Associates, Inc.

Sudman, Seymour, Bradburn, Norman, Schwarz, Norbert. 1996. *Thinking about Answers. The Application of Cognitive Processes to Survey Methodology*. Jossey-Bass.

Train, Kenneth. (1993). Estimation of Net Impact from Energy Conservation Programs. Submitted to the Southern California Edison Company.

Violette, Daniel M.; Rathbun, Pamela. (2017). Chapter 21: Estimating Net Savings – Common Practices: Methods for Determining Energy-Efficiency Savings for Specific Measures. Golden, CO; National Renewable Energy Laboratory. NREL/SR-7A40-68578. <http://www.nrel.gov/docs/fy17osti/68578.pdf>

Weiss, Carol H. 1998. *Evaluation Methods for Studying Programs and Policies*, 2nd Edition. Upper Saddle River, New Jersey: Prentice Hall.

Wooldridge, J. M. (2002). *Econometric Analysis of Cross Section and Panel Data*. Cambridge: MIT Press.

Yin, Robert K. 2003. *Case Study Research. Design and Methods*. Thousand Oaks, CA: Sage Publications, Inc.

Attachment B: Effective Useful Life for Custom Measure Guidelines

The following guidelines should be used to determine the EUL values for custom measures and programs:

- The EUL values in TRM Section 3 and Section 4 are deemed. Attachment B **Error! Not a valid bookmark self-reference.** and Table 1-4 are a result of research into EUL values for custom measures and are also considered to be deemed.
- Identify the custom measure and consider if there are similar measures with EUL values already in TRM Section 3, Section 4, Table 1-3, or Table 1-4.
- Use the EUL for the similar measure or follow the guidance of Table 1-3 or Table 1-4 for Custom Other categories.

The evaluator will not change deemed values presented here for applicable custom measures and projects within the applicable program year of this TRM. The deemed values will apply to the verified lifetime savings and CPAS. As a result, the implementation team should be consistent and comprehensive in its documentation of the identified EUL if seeking a change for future years. Guidance for EUL research is offered following Table 1-4.

Table 1-3. Non-Residential Custom Measure End-Use Categories, Subcategories and Effective Useful Life Values

Program/End-Use Category	End-Use Subcategory	Sample Mapped Measures	EUL (years)	Notes
Combined Heat and Power	Combined Heat and Power	CHP	Capped at 25	Project specific
Compressed Air	Custom Compressed Air – Equipment	Compressed Air Pressure Reduction Low-Pressure Blower System (replacing compressed air)	15	Default value Future research may show that EULs for compressed air measures vary significantly between equipment and controls.
	Custom Compressed Air – Controls	Compressed Air Flow Controller		
	Compressed Air Leak Repair	Compressed Air Leak Repair	1 - 5	A range of possible lifetime values is provided. Therefore, the implementers of this measure must justify the reason for selecting an appropriate measure life for each project and the decision will be subject to evaluation with the risk of adjustments. ¹¹²
Data Centers	Custom Data Centers - Equipment	Data Center	15	Default values Future research may show that EULs for data center measures vary significantly between equipment and controls.
	Custom Data Centers – Controls		15	
Energy Management System	Energy Management System	Energy Management System	15	Default values

¹¹² Note during IL TRM v7.0 updates, this assumption was discussed at length with the realization that there is a lack of a strong source for defaulting the lifetime and different applications may vary significantly.

Program/End-Use Category	End-Use Subcategory	Sample Mapped Measures	EUL (years)	Notes
HVAC	Custom HVAC – Equipment	Custom Electric HVAC	13	Default values
		VAV Fume Hood		
		Chilled Water Reset		
	Custom HVAC - Controls	Fume Hood Occupancy Controls	15	
		Electric HVAC Controls		
		Low-Flow High Performance Hood -		
		Reduce/Optimize Air Change per Hour (ACH) Rate - Chiller		
		Sash Stops		
Lighting	New Construction/ Custom Lighting	Ceramic MH Lamp	15	Section 4.5.8 of the TRM covers 'Miscellaneous Commercial/Industrial Lighting'. It applies to “energy efficient lighting upgrades that are not captured in other measures within the TRM”. The measure applies to retrofits and appears to be applicable to any non-prescriptive lighting measures, which would imply a 15-year measure life for custom lighting measures. It does not cover new construction or controls, thus the recommendation to include these subcategories.
		New Construction Lighting		
	Custom Lighting - Controls	Advanced Lighting Control Systems	10	
Non-Res New Construction	Non-Res New Construction	New Construction – Electric Measures	17.4	
		New Construction – Gas Measures	20.6	
Commercial Behavioral and Operations and Maintenance Programs	Commercial Behavioral and Operations and Maintenance Measures ¹¹³	Remote HVAC or Lighting Control Changes	6	
		Manual HVAC or Lighting Control Changes	2	
		Unknown (manual or remote)	4	

¹¹³ These behavioral and O&M measures differ from other measure types in that a person must perform an action and this action must be checked periodically to ensure compliance. The savings of these measures depend on ongoing human interventions that may or may not continue to occur over time.

Program/End-Use Category	End-Use Subcategory	Sample Mapped Measures	EUL (years)	Notes
Refrigeration	Custom Refrigeration	Efficient Refrigeration Condenser	15	Default value
		Floating Head Pressure Controls		Research may show that EULs for refrigeration measures vary significantly between equipment and controls.
		Refrigerated Cases		If that is not the case, the recommended end-use subcategory will continue working well.
		Refrigeration Compressor		If that is the case, at that time the end-use subcategories should be updated to the following:
		Refrigeration Controls		Custom Refrigeration – Equipment Custom Refrigeration – Controls
Commissioning	Retro commissioning	RCx Measures	8.6	Research may show that EULs for RCx measures vary significantly between RCx categories or RCx delivery methods. If that is not the case, the recommended program level value will continue working well.
	Virtual Commissioning	Remote and Onsite Control Adjustments	7.3	Based on assuming that 70% of program activity is implemented via the building automation system and 30% are by other means: <ul style="list-style-type: none"> • RCx EUL of 8.6 years (weighted at 70% reflecting the BAS implemented measures) • Non-BAS implemented measures use a proxy averaging the following values to 4.3 years (weighted at 30%): <ul style="list-style-type: none"> ○ SEM EUL of 5 years ○ Remote changes of 6 years ○ Manual changes of 2 years This weighted average calculates to an EUL of 7.3 years.
Strategic Energy Management	Strategic Energy Management	SEM	7	Only applicable to behavior or operational measures.

Program/End-Use Category	End-Use Subcategory	Sample Mapped Measures	EUL (years)	Notes	
Business Energy Analyzer	Business Energy Analyzer	BEA	7.8	Based on Guidehouse survey on ComEd BEA users between December 15, 2022 and January 12, 2023 ¹¹⁴	
Custom	Custom – Gas	Process Furnace Replacement Process Dryer Process Heaters	Custom	Confirmed case-by-case, or use 25 years where available information is not definitive	
		Grain Dryer	20		
		Dock Door Seals	7.5		
		Industrial Laundry Equipment	14 (barrier washer)		
			14 (washer extractor)		
			13 (pass-through tumble dryer)		
			13 (tumble dryer)		
		15 (cabinet dryer)			
		Cremators	18		
		Steam Generators	20		
Boiler Blowdown Controls	25				
Reverse Osmosis (RO) System	15				
Barrel Wraps for Injection Molders and Extruders	Custom	This category is intended to capture unique, one-off projects/measures that do not fall under the other recommended end-use categories. Each project/measure should have a custom EUL. To achieve this, the implementer will provide an ex ante EUL for the project/measure and the evaluator will assess it for reasonableness and revise as necessary.			
Blowers					
Building Envelope					
Controls					
Cooling Tower/Heat Exchanger			As a last resort where there is no basis for a custom EUL a default of 13 years is provided and is deemed appropriate for electric measures, and a default of 17.4 years is provided and is deemed appropriate		
Filter					

¹¹⁴ Respondents were included in the sample if they logged onto the BEA portal at least once (not including their initial enrollment) in 2021 and 2022. This led to a final sample of 1,881 unique user accounts for the survey, with 151 completing the survey. Guidehouse reviewed the responses and estimated an EUL of 7.8 years for energy efficiency activity completed in 2021 and 2022, within the timeframe of using the BEA tool, outside of activity within existing ComEd programs. This weighted EUL of 7.8 years is based on the effective useful life of the measures implemented outside of other programs when the users also indicated influence in completing these measures from the BEA tool.

Program/End-Use Category	End-Use Subcategory	Sample Mapped Measures	EUL (years)	Notes
		Injection Molding Machine		for natural gas measures.
		Low Pressure Drop High Efficiency (Non-HEPA) Air Filters		
		Piping/Duct Modification		
		Pump/Fan Replacement		
		Vacuum System		

Table 1-4. Residential Custom Measure End-Use Categories, Subcategories and Effective Useful Life Values

Program/End-Use Category	End-Use Subcategory	Sample Mapped Measures	EUL (years)	Notes
HVAC	Thermostat Optimization	Thermostat Optimization	2	For up to two year’s application of the optimization to the same customers. A third or more year applications would have a one year measure life until evidence of persistence is available. ¹¹⁵
Res New Construction	Res New Construction	New Construction Electric Measures	18	
	Affordable Housing New Construction	Affordable Housing New Construction	-	Varies by project based on implemented measures

Guidance for EUL Research

The complexities of the various approaches for custom-like programs require a program-by-program perspective. The following process should be used when researching a new EUL value for custom measures. Similar to first year energy savings calculations, appropriate documentation should be provided to support the EUL value which may include references, approach, and reasons.

1. Identify the non-TRM measure and consider if there are similar measures with high quality EUL values already in the TRM. This initial step provides a benchmark for the EUL value.

¹¹⁵ This limit to the two year measure life is due to the fact that the optimization builds upon itself; that is, if a thermostat is optimized during a cooling season the setpoints will remain at the optimized levels when that thermostat switches back into cooling mode in the following year, and further optimization applied in that year will change setpoints even further compared to the pre-optimization levels. As the setpoints get more and more extreme from repeated optimizations it is likely that the rate of manual adjustments to the setpoints goes up (thus overriding the optimized setpoints) which shortens the measure life.

2. Review the sources used to determine the EUL values for those similar measures. See **Error! Reference source not found.** and Table 1-4.
3. If the sources do not have EUL documentation for the non-TRM measure, research additional sources. The level of research effort should be commensurate with the savings potential for the non-TRM measure.
4. Submit the recommended EUL value and documentation for the non-TRM measure to the TRM Technical Advisory Committee for review through the annual TRM update process.

Source quality will be determined using hierarchy to describe the strength of the identified source as shown in **Error! Reference source not found.** below. In cases where a range of values are provided by a source versus an absolute EUL, the median value should be used. In other cases, if more than one high quality source is available with conflicting values, the one with primary research data with strong confidence in the findings should prevail, otherwise, the average EUL should be calculated.

Source Name	Description
TYPE 1: Sources identified as highest strength:	
Primary research conducted or vetted by third-party entities such as trade organizations, national labs, or government organizations	
1.1	<p>U.S. Department of Energy Federal Energy Conservation Standards</p> <p>The U.S. Department of Energy (DOE) produces Technical Support Documents (TSD) detailing the analysis behind the federal conservation standards established for each product it regulates. Each TSD contains a chapter, often titled “Life Cycle Cost and Payback Period Analysis”, that offers DOE’s EUL estimate for the product and explains how this value was derived. Although the method depends on the data available for a given product, DOE’s analysis generally relies on some combination of primary research, secondary research, modeling, and/or input from industry experts. The TSDs are linked from DOE’s rulemaking page for each product, https://energy.gov/eere/buildings/standards-and-test-procedures.</p> <p>The TSD measure life values are based on shipment data, secondary literature research and primary research which include discussions with industry experts. Navigant considers as high quality because of the stakeholder review process and due diligence required to create these documents. Only the best available sources are used to support the EUL values used in life-cycle cost analysis for DOE federal equipment standards.</p>
1.2	<p>LED lighting reports prepared by Navigant</p> <p>Navigant has performed extensive market research on the state of LED lighting for the US. DOE Solid State Lighting Program most recently published in 2016. It includes typical lifetime operating hours for each lamp type by sector. https://energy.gov/sites/prod/files/2016/09/f33/energysavingsforecast16_2.pdf</p>
1.3	<p>Appliance Magazine</p> <p>Appliance Magazine publishes an annual report on the market value, life expectancy, and expected unit replacements for a range of consumer appliances. The appliances listed in this report change from year to year, so older versions of the report may be referenced for products no longer listed. As noted in the report, these EUL estimates represent the expert judgment of magazine staff based on input obtained from many sources. Portrait of the U.S. Appliance Industry (2001-2009). U.S. Appliance Industry: Market Share, Life Expectancy and Replacement Market, and Saturation Levels (2010). U.S. Appliance Industry: Market Value, Life Expectancy and Replacement Picture (2011-2014).</p>

	Source Name	Description
1.4	C&I Measure Life and Persistence Project	In 2011, Northeast Energy Efficiency Partnership sponsored this study of EUL of commercial and industrial lighting. The primary objective of this study was to conduct primary and secondary research and analysis for estimates of measure lifetimes that included on-site verification of CFL bulbs and fixtures, LED exit signs, HID fixtures, and T8 fixtures. Installations occurred from 1999-2009. http://www.neep.org/sites/default/files/resources/NEEP_CI_Persistence_Report-FINAL.pdf

TYPE 2: Sources identified as medium-high strength:

Meta-analyses conducted by third-party organizations, that show some level of evaluating the studies that comprise the dataset

2.1	California DEER	The most recent and comprehensive DEER documentation of EUL sources was from 2008 and 2014. The 2008 version identifies all the sources reviewed and justification for selected measure life. The 2014 measure list identifies the source used for the measure life. Many of the original references are from 2005, http://deeresources.com/files/deer2005/downloads/DEER2005UpdateFinalReport_ItronVersion.pdf , p. 11-1.
2.2	Regional Technical Forum (RTF) reference workbook	Ongoing revisions as measures undergo review. Similar to the 2008 DEER, the RTF identifies all the sources reviewed and justification for selected measure life.
2.3	GDS Reports	GDS Measure Life Report Residential and Commercial/Industrial Lighting and HVAC Measures – 2007. This study used various data sources such as DEER, state TRMs, and evaluation studies with a working group to review and decide on each value.
2.4	Focus on Energy Report	Focus on Energy Evaluation Business Programs: Measure Life Study Final Report: August 25, 2009 – this is a critical review of studies, workpapers and technical guides including a review of the underlying sources or supporting research.
2.5	ASHRAE	Original source is from Akalin, M.T. 1978. Equipment life and maintenance cost survey (RP-186). ASHRAE Transactions 84(2):94-106; Recent work is ASHRAE system life database (research project 1237-TRP) - which is a crowd-sourced approach to collecting actual system data. https://xp20.ashrae.org/publicdatabase/system_service_life.asp?selected_system_type=7

TYPE 3: Sources identified as medium strength:

Compilations conducted by third-party organizations. Original sources should be cited, and locatable where applicable

3.1	State TRMs	Many state TRMs reference each other and other sources of varying strength. Due diligence on reference documentation is not always present for the measure life. Many TRMs are reviewed via a stakeholder process.
3.2	ENERGY STAR calculators prepared by U.S. EPA and DOE (depending on the references used)	EPA’s Energy Star offers calculators to help consumers and businesses estimate the energy and cost savings that could be realized by choosing to buy Energy Star certified products. Within these calculators, Energy Star offers a typical EUL and cites the source. Energy Star generally cites a single high-quality source (e.g., DOE, Appliance Magazine) for each EUL value and offers no analysis or discussion of the selected value. Energy Star’s calculators can be accessed at www.energystar.gov . For example, their appliance calculator is available at www.energystar.gov/sites/default/files/asset/document/appliance_calculator.xlsx .

Source Name	Description
TYPE 4: Sources identified as medium-low strength:	
Primary research conducted by interested parties such as manufacturers, distributors, retailers or installers	
4.1 Interview with interested parties (with no statistical rigor or analysis)	Manufacturer, distributor, installer, etc. have a vested interest and may overstate the benefit.
TYPE 5: Sources identified as low strength:	
Source where the basis of measure life is anecdotal, based on design specs, warranty period, etc.	
5.1 Industry blogs, Implementer or evaluator experience	Typically based on professional judgment and not rooted in any data.

Attachment C: Framework for Counting Market Transformation Savings in Illinois

1 Market Transformation Context

This Attachment was developed in 2019 within the Illinois Energy Efficiency Stakeholder Advisory Group (SAG) Market Transformation Savings Working Group, to describe a high-level framework for estimating savings from Market Transformation (MT) initiatives. MT protocols will need to be developed for individual MT initiatives as they are launched and may be documented in the IL-TRM or by posting agreed-upon protocols to the SAG website. The development and future inclusion of MT initiative-specific protocols in the IL-TRM will (1) help to ensure consistent evaluation approaches are used for similar MT initiatives that are offered throughout the state and (2) provide utilities with greater certainty as to how specific MT initiatives will be evaluated.

This Attachment is divided into two sections. The first gives the context of Market Transformation and describes some of its unique features that influence the estimation of savings. The second describes high-level methodologies for determining savings from MT initiatives.

1.1 Market Transformation Definition

This attachment uses the following definition for Market Transformation which is also used by the Midwest Market Transformation Collaborative and is very similar to definitions used by other organizations:

Market Transformation is the strategic process of intervening in a market to create lasting change that results in the accelerated adoption of energy efficient products, services and practices.

1.2 Market Transformation and Resource Acquisition

An MT initiative (MTI) can include intervention activities similar to those seen in standard Resource Acquisition¹¹⁶ (RA) programs, such as incentives that reduce first costs, training for trade allies, and marketing and case study materials¹¹⁷. However, MT initiatives additionally include activities that specifically seek to affect the long-term structure of a market in ways that are not easily undone; for example, working directly with manufacturers on product specifications and features or engaging with ENERGY STAR and DOE on test procedures and rulemakings.

Figure 1 depicts the types of activities that might be included in an MT initiative. There are a number of other potential actions, such as discussions with stakeholders and setting up an evaluation plan, but that is not the subject of the figure. An example of an MTI with multiple interventions is the Heat Pump Water Heater (HPWH) Initiative¹¹⁸ in the Northwest. Interventions include: technical support for development of ENERGY STAR specifications; laboratory testing of new HPWH to prove performance claims; upstream manufacturer engagement including incentives to encourage aggressive market pricing; customer facing retail rebates; providing technical information to the US DOE standards process in support of HPWHs being cost-effective for large tank sizes; and working with local jurisdictions to develop code provisions that provide “extra-credit” for HPWH in new construction.

¹¹⁶ Resource acquisition is defined in the glossary but is used loosely in this Attachment to refer to more traditional utility driven energy efficiency programs that typically work at the individual consumer level, rather than the market level.

¹¹⁷ For a review of best practices for designing and implementing market transformation initiatives, see Keating (2014).

¹¹⁸ A description of this initiative can be found in recent reports from NEEA: <https://neea.org/resources/northwest-heat-pump-water-heater-initiative-market-progress-evaluation-report-3> or <https://neea.org/resources/northwest-heat-pump-water-heater-initiative-market-progress-evaluation-report-4>

Figure 1. Examples of Potential MT Activities Under a “Theory Umbrella”

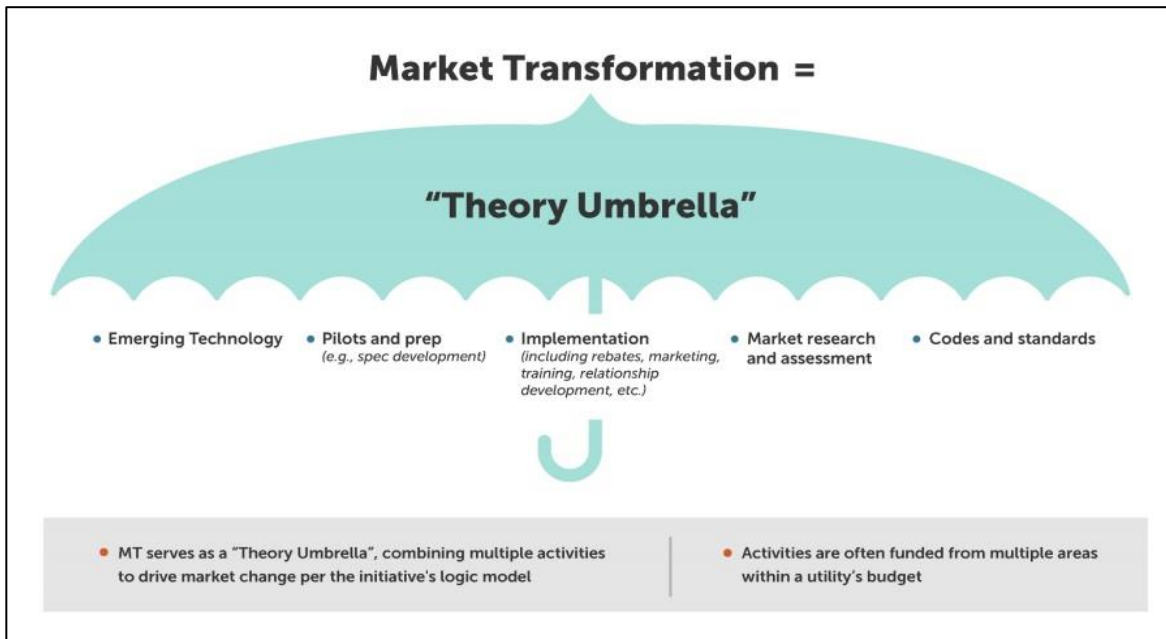

Each MT initiative must establish its own unique overarching MT theory with an “umbrella hypothesis” under which a variety of strategic activities, including those that may occur through other parts of the utility or even other organizations, can be combined to affect the desired market change. The goal of this set of activities is to reduce market barriers and leverage opportunities to create lasting market change. The entire set of activities is incorporated in the overall MT initiative hypothesis and logic model, even if some of those activities might be funded or implemented from different budgets or organizations.

RA activities can also result in market changes,¹¹⁹ and RA savings approaches may also include documenting market effects for those programs independently from an MT initiative. However, RA savings are normally measured through participation in a program rather than whole market effects. There are further differences between RA and MT that influence the methods for calculating savings; key differences are shown in Table 1 below. Accounting for overlap in MT and RA program savings is discussed in a later section of this attachment.

Although an MT initiative might include activities similar to those employed in an RA program under the MT Theory Umbrella, the significant differences between MT and RA program types provide important context for planning, implementation and evaluation. As summarized in Table 1 below, these differences include: the scale of the intervention, the target market, the ultimate goal, the fundamental program approach, the time frame over which cost effectiveness must be evaluated, the amount of program administrator (PA) control, and the set of activities that are tracked, measured and evaluated.

Table 1. Comparing Resource Acquisition Programs and Market Transformation Initiatives¹²⁰

	Resource Acquisition	Market Transformation
Scale	Program Administrator’s service territory	Entire defined market

¹¹⁹ For example, NMR Group, Inc. (2014) reviews methods for the evaluation of market effects primarily (though not exclusively) for RA programs.

¹²⁰ Source: adapted from Prahl and Keating, 2014; derived in turn from Keating, et al. and Sebold et al., 2001.

	Resource Acquisition	Market Transformation
Target	Whoever can be induced to participate	All consumers of a particular product or service
Goal	Near-term savings	Structural changes in the market leading to long term savings
Approach	Save energy through customer participation	Save energy through mobilizing the market
Scope of Effort	Results from a single program	May result from effects of multiple programs or interventions
Level of Program Administrator Control	PAs can control the pace, scale, geographic location, and can usually identify participants	Markets are very dynamic, and the PAs are only one set of actors. If, how, where, and when the impacts occur are usually beyond the direct control of the program administrators
Evaluation and Measurement	Energy use and savings, participants, free-ridership, and sometimes spillover	Interim and long-term indicators of market progress and structural changes, attribution to the program, and cumulative energy impacts
Timeframe for planning, savings measurement, and cost-effectiveness	Typically based on annual or multi-year planning and reporting cycle savings	Typically planned and implemented over a 10-20 year timeframe

Historically, the differences between the two approaches have resulted in challenges for MT initiatives to thrive in states where policy frameworks are strongly focused on resource acquisition.¹²¹ The much longer time frame for MT initiatives and the lesser degree of program administrator control can be difficult to reconcile with policy rules that are focused largely on the precise quantification of annual savings.¹²² Evaluation of savings can be fraught in jurisdictions where financial incentives or penalties are determined based on evaluated results, and can be particularly challenging for MT initiatives, which require market analyses that introduce additional uncertainty. Operating MT initiatives under these conditions requires upfront negotiation on evaluation processes to set clear expectations on measurement approaches.

1.3 Market Transformation and Attribution

The concept of attribution - or the attempt to assess the extent to which observed outcomes are caused by the program(s) of interest as opposed to events that would have happened regardless of any intervention - is fundamental to the evaluation of energy efficiency programs¹²³. Without attribution, it is difficult to understand the success or failure of a program – or to improve (or to justify continued public funding for) a program whose success or failure is not understood.

¹²¹ Note, for example that a regulatory framework supporting the MT initiative is cited as one of three “must-have components” for MT to thrive in a recent Illinois Summit on MT. ComEd Energy Efficiency Program “Energy Efficiency Market Transformation Summit Report”, Navigant Consulting, February 2019.

¹²² For a comprehensive discussion of the challenges of reconciling MT and RA within an RA-dominant policy framework, see Prah and Keating (2014).

¹²³ See additional discussion on attribution in the Illinois Technical Reference Manual, Volume 4: Cross-Cutting Measures and Attachments, Section 2.

While attribution is relevant to both market transformation initiatives and resource acquisition programs, there are important differences to approaching attribution between the two types of programs. For resource acquisition programs, it has long been the norm in much of the US to treat attribution as a continuous variable that can be quantitatively scored (often in the form of a net-to-gross ratio that adjusts for free ridership and spillover) and applied to savings claims at frequent intervals with relative granularity. RA programs can ask questions directly of actual participants to ascertain attribution. However, MT initiatives typically do not lend themselves to this type of quantitative approach. More often than not, there is too much elapsed time over the lifecycle of a MTI and too many other market forces at work for a strictly quantitative attribution score to be meaningful on an annual basis. Instead, market transformation also requires qualitative judgements as to whether the initiative was generally successful in causing the intended market changes over extended periods of time.¹²⁴

Successful incorporation of MT initiatives into a program portfolio that is dominated by resource acquisition programs generally requires that stakeholders accept these methodological differences between the two program approaches.

It is important to note this does not imply that quantitative estimates of savings should not be made for MT initiatives; fundamentally, all Illinois efficiency programs will need to quantitatively estimate saving, as long adopted policy requires counting the savings toward goals and estimating program cost-effectiveness. It simply means that savings for MT initiatives will be significantly less certain by nature than those for pure RA programs. Defensible methods for dealing with the limits to quantifying attribution for MT initiatives are discussed at length later in this attachment.

1.4 What Makes an MT Initiative Recognizable?

Because of the difference in evaluation approaches between an MT initiative and an RA program, it is important to first confirm whether an initiative falls into the MT category or the RA category before developing savings estimates.

To qualify as an MT initiative, there needs to be a clearly delineated target market,¹²⁵ as well as a documented theory of change in this market (or MT hypothesis) that is embedded in a defensible logic model.¹²⁶ This logic model provides the linkages between program activities and the anticipated lasting market change that accelerates the adoption of energy efficiency. The logic model is documented in the MT Business Plan¹²⁷ or similar document and is developed in advance of executing market interventions. MT initiatives are not created by looking backward and claiming credit for market changes from previous programs. Nor are all “upstream” programs MT by default. For example, an upstream program may not be designed to affect lasting change to the market; instead, the market would revert to its prior condition once the program incentive is removed.

2 Market Transformation Energy Savings and Evaluation

Energy savings from MT initiatives are the end result of increased and accelerated market adoption over and above a hypothesized future that would have happened without the MT initiative. Attributing savings to MT initiatives requires the assumption that some portion of the observed changes in market adoption are the direct result of a targeted, strategic market intervention that was designed and implemented to achieve that result. The MT framework requires both validation of the MT initiative logic and an evaluation of program implementation and

¹²⁴ In this regard, the evaluation of market transformation initiatives closely resembles most other fields of social program evaluation, and it is actually the evaluation of resource acquisition programs that is unusual. For example, evaluations of early intervention education programs such as Head Start routinely concern themselves with the issue of attribution, but they generally do not seek to construct a quantitative attribution score for a specific program, region, and year.

¹²⁵ As shown in the glossary, this paper uses the following common definition of a market: an actual or nominal place where forces of demand and supply operate, and where buyers and sellers interact (directly or through intermediaries) to trade goods, services, or contracts or instruments, for money or barter.

¹²⁶ In some regions of the country, this is called a “program theory.”

¹²⁷ The content of an MT Business Plan is listed in Appendix A.

progress towards specific market progress indicators (MPIs) before savings can be estimated.

The following section discusses several core concepts specific to the evaluation of MT initiatives.¹²⁸

2.1 Theory-based Evaluation

Methodologically, MT evaluation tends to rely heavily on Theory-Based Evaluation (TBE).¹²⁹ TBE starts with a theory of change that explains how an intervention is expected to produce results. Because the subject of evaluation is an entire defined market rather than a program and its readily identifiable participants, MT evaluations tend to require numerous pieces of evidence that 1) change is occurring; and 2) the program is influential in causing that change.¹³⁰ This theory of change is embodied in the logic model that is the core of an MT initiative. A logic model provides the relationships and connections between program activities and anticipated changes in the market over the short, medium, and long term.

Evidence of a program's influence on its target market is gathered through an assessment of Market Progress Indicators designed to judge whether the program is achieving its intended outcomes. MPIs are market-based milestones associated with progress hypothesized in the logic model and confirmed as appropriate real-world indicators of progress. Examples of MPIs include market share of an efficient product option, changes in product availability, or evidence of promotional activity by affiliated or unaffiliated market actors. It is important to have a mix of leading indicators which provide timely feedback on the near-term progress of the program and the market (such as early shifts in market share), as well as lagging indicators which can be used to help assess longer-term outcomes (such as new entrants in the supply chain for the energy-efficient product). Regular assessment of MPI progress plays a central role in building a qualitative case for attribution over time via theory-based evaluation.

Assessment of MPIs will require incorporation of multiple judgements of progress based on a preponderance of evidence approach. It is important to note that "preponderance of evidence" does not require that all indicators show overwhelming evidence of programmatic influence, but rather that multiple indicators show consistent direction. This information can be qualitative (based on in-depth interviews or observational data collection) or quantitative (based on market share or production data). Evaluation plans for MT initiatives should propose evidence-gathering approaches to meet the "Preponderance of Evidence" standard.

Potential research needs and other evidence-gathering activities should be discussed and agreed upon by Program Administrators, Stakeholders, and Evaluators and documented in the MTI Evaluation Plan.

2.1.1 Market Progress Evaluation Reports

To evaluate a market transformation initiative effectively, it is essential to conduct regular research to understand market changes and implications for program adaptation. The Northwest Energy Efficiency Alliance (NEEA) refers to these regular evaluations as Market Progress Evaluation Reports (MPERs) and typically executes one per initiative yearly.¹³¹ MPERs include components of impact and process evaluation, market research, and planning and market

¹²⁸ For a comprehensive review of best practices for the evaluation of market transformation initiatives, see NMR Group, Inc. (2013). For a more condensed discussion, see Prah and Keating (2014). Metrics, Tracking, and Performance Assessment Working Group (2018) provides a regional perspective by discussing New York state's approach to the evaluation of its market transformation efforts. Also see Navigant (2018) for a discussion of best practices in MT design. Finally, it is important to keep in mind that both market transformation initiatives and resource acquisition programs can cause market effects; NMR Group, Inc. (2014) reviews methods for the evaluation of market effects primarily (though not exclusively) for RA programs.

¹²⁹ See Chen (1990) or Weiss (1998). TBE is also often useful for resource acquisition programs but tends to be particularly central for the evaluation of market transformation initiatives. For a discussion of the application of TBE to energy efficiency programs in general, see Section 6.9 in Attachment A of the cross-cutting protocols.

¹³⁰ Examples might include: changes in efficient market share or product positioning; changes in leading indicators such as distributor stocking practices, consumer awareness, or new vendors entering into the market; self-reports of program effects from market actors; evidence of change in the prevalence of training/credentials, sales or installation data,—basically, evidence that the efficient option is being "normalized".

¹³¹ In other regions, such recurring efforts may go by other names. However, the general concept of regular, recurring efforts

assessments and are designed to document progress and market change over the initiative’s life cycle. It usually takes multiple MPERs over time to tell the complete story of an initiative. The MPER scope is centered around 1) an assessment of the strength of remaining barriers and 2) measurement of Market Progress Indicators.¹³²

2.2 Energy Savings Framework

Along with a program logic model, it is recommended that an Energy Savings Framework (ESF) be developed for every MT initiative. The ESF is the quantitative service-territory-level characterization of the market history and projections of the energy-efficient product or service, including 1) the expected energy and demand impact of the MT initiative and 2) the SAG-reviewed natural market baseline with defined utility attribution methodology. The ESF is a component of the MT Business Plan and reflects the impact of the MT initiative and program logic on the utility’s portfolio. ESFs need to be developed for each MT initiative that doesn’t already have one. For existing MTI’s, the ESF should be evaluated each year to assess the need for an update, as described in section 2.3.

For each new MTI, sponsoring utilities and their implementation contractors, with input from evaluators, should submit an initial Energy Savings Framework to other Program Administrators, Commission Staff, and the SAG by September 1 of the ~~current~~ year prior to implementation. The ESF shall follow a consistent format that includes the requisite information. In early September, the utilities will present the rationale supporting the specific details for the ESF to the evaluator and other stakeholders and provide the SAG, in their advisory role, with an opportunity to review, question, and suggest modifications to the initial ESF. This process also applies to revisions to existing ESFs for in-process MTIs.

SAG participants shall make best efforts to reach consensus regarding new ESFs and revisions to existing ESFs. If the SAG reaches consensus regarding an appropriate ESF, or revision to an existing ESF, by October 1, then the SAG agreed-upon ESF shall be applied to the upcoming Program Year, even if it differs from the initial recommended ESF. If the SAG cannot reach consensus on an ESF, or revision to an existing ESF, prior to October 1, then the Evaluators’ final recommended ESF shall be applied, which may be different from the initial proposed ESF¹³³. In developing the final ESF, the Evaluator shall review SAG feedback, consider all comments and discussions, with the intent of making the best revisions to the ESF for the upcoming Program Year.

A “Comparison Exhibit of Non-Consensus TRM Update Issues” will be developed by the Evaluator with input from the parties and document the various parties’ positions concerning a non-consensus. This Exhibit will be included with the Staff Report submitted to the Commission.

Gas utility annual energy savings goals will be adjusted for the entire Plan period, prior to the start of the first Plan Year of an approved Plan so that they are aligned with all current IL-TRM values, and the most recent SAG-agreed-upon (or Evaluator-recommended) MTI ESF.

2.2.1 Data Sources

In practice, planning a market transformation initiative requires developing a process for obtaining sufficient market data to enable the establishment of a reasonable baseline, as well as for on-going estimation of savings from the MT initiative. The ESF should identify these sources of information and how the data will be used. Below are a few of

to understand the progress of a market transformation initiative is widely accepted in the energy efficiency industry. This paper uses the term MPER for envisioned MT evaluations in Illinois. For examples of completed MPERs, see <https://neea.org/resources-reports>

¹³² Market Progress Indicator is the term used in the Pacific Northwest. A closely related term that is often used in other regions of the country is “market indicator,” although there are shades of differences in the meanings of the terms.

¹³³ SAG consensus is the desired outcome, but if consensus cannot be reached, the SAG will follow the same process outlined in sections 3.10 Consensus Decision-Making and 7.2 Net-to-Gross Policy, in the Illinois Energy Efficiency Policy Manual. https://www.ilsag.info/wp-content/uploads/IL_EE_Policy_Manual_Version_2.1_Final_12-7-2021-1.pdf

the approaches to meet this requirement:

1. **Full category sales¹³⁴ or market practice data.¹³⁵** Market analyses are most comprehensive when they include full category data from key actors in the supply chain, such as retailers or distributors. They can reveal unexpected trends in product categories that inform both trendlines and program interventions. These data make it possible to understand the market share of the efficient product relative to its competitive set.
2. **Primary data collection and extrapolation.** Because full category data is rarely available, primary research within the target market is frequently used to develop an understanding of the current level of market activity, including the portion consistent with the efficiency threshold sought by the program. Surveys with robust samples of trade allies, design professionals, and distributors can provide data on the square footage, sales in dollar value, project volume or denominator of interest. In cases where downstream rebate programs are operating in tandem with MT engagement, rebate processing data can provide a detailed look at a slice of the total market. Similarly, some upstream programs will be able to collect actual primary sales data on market share for some or all of the market.
3. **Secondary market data.** Regardless of the data available to the program, it is also best practice to include a scan for other sources of market data that might be available outside of the energy-efficiency community. Investment briefs, product trend analyses, JD Power or Consumer Reports data, and industry data often gathered by trade associations or similar organizations such as the Association of Home Appliance Manufacturers, NPD Group, Heating Air-conditioning Refrigeration Distributors International, etc. may provide important insights.

2.2.2 Factors in Estimating MT Savings

Three key factors must be considered when estimating MT savings. The first is the Total Market Savings that result from the entire market adoption of energy efficiency products or services. The second is the Natural Market Baseline, which is a forward-looking estimate of the market in the absence of any utility-funded energy efficiency activities. Figure 2 illustrates these two factors.¹³⁶

¹³⁴ MT initiatives can also operate on buildings (like multi-family ordinances), engage corporations (like Strategic Energy Management), or even drive behavior change (like Building Operator Certification) – assuming they are structured as MT. The goal is still to gather total units as well as efficient units.

¹³⁵ Full category sales data includes all sales within a product category such as clothes washers -- both efficient and inefficient units.

¹³⁶ Not illustrated in the figure are further adjustments for savings from RA programs operating in the same market or allocations of the market savings to individual utility service territories. These are discussed in subsequent sections.

Figure 2. Framework for MT Savings

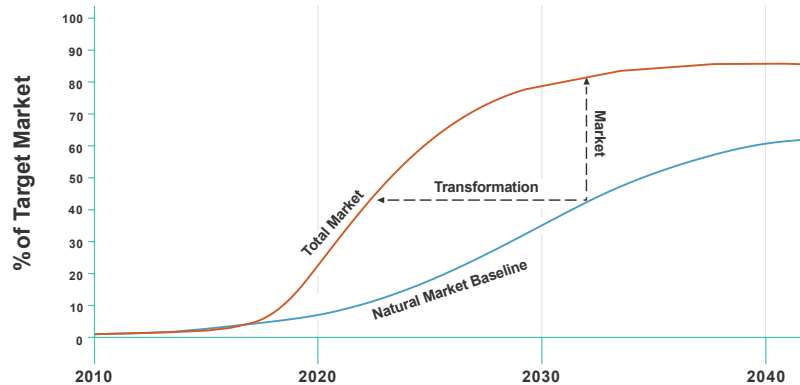

The third and final factor in estimating MT savings is the removal of savings specifically tied to RA programs operating in the same market to prevent double counting; this is described in Section 2.4. After all three factors are considered, then MT savings are typically allocated to individual service territories.

2.2.3 Estimating Total Market Units

Each market will have unique characteristics and data sources for tracking units. In many markets, extrapolations or approximations based on best available information will need to suffice. Ideally, the initiative should try to track both the total number of units in the market and the portion of units that meet the efficiency specification in the MT initiative (efficient units). Over time, Market Progress Evaluation Reports will describe shifts in the relationship between the numbers of efficient units and total units; the ratio of efficient units to total units represents the market share of efficient units.

In the case of gas-heated new home construction, for example, Market Progress Evaluation Reports would collect public information on new gas-heated housing starts and track the number of new homes meeting a particular efficiency specification. In mass markets, like appliances and commercial food service equipment, the best market data often resides with key market actors, like large distributors or manufacturers. In these cases, the design of the initiative should include a plan to secure sales data for the whole product category and the efficient units as an inherent part of the initiative’s implementation. If not secured at the beginning of an initiative, this data can be difficult or impossible to secure later. As a result, it is optimal to design this data collection into the initiative when starting strategic partnerships with the market actors.

In many cases an initiative is unlikely to have participation from distributors, manufacturers and/or retailers that cover sales in 100% of the market. In this case factors need to be developed to extrapolate the data that is available for a portion of the market to the rest of the market.

2.2.4 Estimating Total Market Savings

Estimating total market savings requires the estimation of MT Units and Unit Energy Savings (UES). MT Units are the result of subtracting Natural Market Baseline Units from Total Market Units. The definition of “units” will depend on the energy-efficient product or service that is the focal point for the MT initiative. Units are defined upfront and typically are measured as: a device; square footage; number of housing units; number of operators; pound of product, etc. The appropriate unit definition will be identified in the MT Business Plan.

Savings are measured in kwh/unit, therms/unit, and kW/unit. Unit Energy Savings are defined as the difference between the unit energy consumption of the baseline product or service and that of the efficient one. This savings delta can be a deemed value already included in the TRM, calculated as part of the planning and baseline work that

informs typical MT programs, or directly tracked or researched. Note that the average savings per unit for a specific market likely will be the weighted average savings per unit for different categories of product (e.g., top-load or front-load clothes washer categories). For the purposes of this document, UES reflect the weighted average of all the categories included in the target market. MT UES is the result of subtracting the Unit Energy Consumption (UEC) of the efficient product/service from the UEC of the baseline product/service, as shown below.

MT Energy Savings = Number of MT Units (Units) x Unit Energy Savings (UES)

Where:

- *Number of MT Units = Number of Total Market Units – Number of Natural Market Baseline Units*
- *Unit Energy Savings = Unit Energy Consumption (UEC) of baseline product/service – UEC of EE product*

Note: Units are adjusted in a subsequent step to account for any overlap between RA and MT.

For MT programs that rely on shifts in practices or sales mixes, an appropriate approach to calculating savings may use the energy consumption embodied in the “standard practice” or “average sales mix,” rather than a single widget-based calculation. When data are not available for the consumption of standard practice or average sales, modelling of an applicable energy code or standard can also be used.

Analysts can review and use existing sources of savings-per-unit information (or base- and efficient- consumption), if applicable. These sources could include TRMs; load forecasts; existing energy efficiency programs within the utility; emerging technology/R&D results; negotiated settlements on particular savings values, or other sources. Relevant information and associated data sources should be included in the ESF document.

If existing sources are not available or do not seem sufficiently reliable, the analyst should develop and implement a plan for securing more information on savings per unit. This may include product testing, piloting, or developing an agreed-upon proxy for use in the near term with a plan for developing more robust savings estimates over the longer term.

2.2.5 The Role of Natural Market Baseline and Attribution

The Natural Market Baseline (NMB) is a forecast of the future in which no utility-funded energy-efficiency programmatic intervention exists. Natural Market Baseline is removed from the Total Market Savings to ensure that the savings counted from ratepayer-funded activities do not include savings that would have occurred absent the utility-funded programs. This is the MT version of “attribution” and no further adjustment for free riders is needed.

As discussed earlier, attribution is typically in part established qualitatively for MT initiatives, yet under the policy framework in place in Illinois, a “net” savings figure must be determined. Subtracting the Natural Market Baseline from Total Market Units is the mechanism by which this is accomplished. Once an initial forecast has been made, the focus of evaluation efforts turns to building a case over time as to whether sufficient evidence exists to establish a link between program activities and market effects that are consistent with that forecast. As discussed below, depending on the body of evidence that emerges over time, the initial forecast for both Total Market Units and the Natural Market Baseline may be revised periodically (as described in Section 2.3). In addition, quantitative adjustments may be made to allocate total savings between sponsors or between MT and RA programs as discussed below.

In principle, subtracting the Natural Market Baseline from total market units yields by definition an estimate of total net savings¹³⁷. Market influence and energy savings characterized in the Energy Savings Framework could be adjusted to account for market impacts due to non-Program causes in the following circumstances:

¹³⁷ This “net” savings includes savings from both MT and RA programs, so the “net” is further adjusted for RA savings, which is discussed in a section below.

- In the case where a utility joins an on-going Market Transformation initiative after the program is already underway and MPI evaluation shows progress prior to the utility joining, savings may be adjusted.
- A Market Transformation Program may target market actors willing to directly participate in the program. The program may indirectly influence the actions of similar market actors who do not participate in the program. Accounting for this indirect influence may result in partial or delayed market impact and savings.
- In the case where the ultimate goal of a Market Transformation Program is to influence the adoption of a new code or equipment standard, the program influence should be considered in the context of other independent influencers seeking the adoption of the same standard. In this case, an additional adjustment to the impact and savings may be applied to account for the attribution of influence on the standard adoption to others.

2.2.6 Natural Market Baseline Units¹³⁸

2.2.6.1 Theory

The Natural Market Baseline should be modeled during the development of the MT initiative with the best available information, and then adjusted over time if significant new data becomes available during the implementation of the initiative, or because of unexpected market disruptions, such as those associated with substitute products.

Typically, the Natural Market Baseline will reflect at least some naturally occurring adoption of the targeted measure or practice because as Prah and Keating (2014) note:

With market transformation, the gross market changes observed over the time horizon of a market transformation initiative are not all linked to the utility or other public policy intervention. Some of it is naturally occurring – even a slow growing product, if it is moving into the market will have an increasing penetration, even without a strategic market transformation intervention. This equates to the non-net portion of resource acquisition. (pp. 45-46)

Forecasting Natural Market Baseline units often assumes that, over time, adoption of energy-efficient technology will follow a normal distribution consistent with Diffusion of Innovation theory. In this theory, market share is small due to a few innovators and early adopters participating in the market in early years, increasing to a majority of adopters during the peak years of market growth and then over time decreasing again to a small number of laggards adopting the product/service. Sometimes MT initiatives are primarily attempting to shift the adoption curve forward in time. Other times, they may be attempting to increase the slope and/or maximum values of the adoption curve

The Natural Market Baseline is probably the most challenging piece of estimating savings from MT because it is a prediction of the future that will never actually exist and therefore cannot be measured. As a result, it is important to involve evaluators and stakeholders in advance to ensure transparency, alignment and understanding of the data and judgement that will ultimately be used to estimate savings. All Market Transformation documents – The Program Plan & Logic Model, the Energy Savings Framework and the MT Program Evaluation Plan should be presented and discussed with Illinois stakeholders as early as possible.

2.2.6.2 Practice

The basic task is to develop a baseline of how the energy-efficient product, service or behavior would have grown in the market independent of utility activity. There are several elements for effectively developing the Natural Market Baseline:

1. **Identify existing data sources** that could inform the Natural Market Baseline and include these in the MT Business Plan. Market or sales data are the best sources, particularly if they are “full category” (or include the full efficiency mix, not just the qualified, efficient units). Other data sources can also be

¹³⁸ The term “Naturally Occurring Market Adoption” or NOMAD is synonymous with “Natural Market Baseline Units”.

used, including industry forecasts, market intelligence and trend information, primary data collected as part of market research or market characterization to support the initiative development, hedonic price modeling, or other information about how efficiency is positioned relative to other market drivers. In addition, trade associations, advisors to the target market/industry, investment grade forecasts or organizations related to regulatory oversight (like Lawrence Berkeley National Laboratory) can be good sources of data. Manufacturers or distributors themselves are excellent sources, but they may be unwilling to share proprietary information.

2. **Use available data, quantitative modeling, best judgement, proxy data or other techniques** to develop a Natural Market Baseline. Some projects lend themselves to modeling or model averaging using statistical approaches to estimating baseline sales behavior. These can incorporate different assumptions about how a program affects product sales. In many cases, multiple approaches can be used. For example, an evaluation completed for Consolidated Edison included a sales model, market share model, probit model¹³⁹ and a model averaging model, which were used in a single project to test different ways of estimating baseline sales.¹⁴⁰ In some cases, a comparison group (such as different but similar region that is not intervening in this market) may be used as a proxy.
3. **Develop the initial baseline curve** and have the shape of baseline curve and underlying assumptions reviewed by stakeholders. Several key product characteristics should be considered when determining the shape of the Natural Market Baseline curve. These characteristics include the maximum potential market share, the pace of innovation within a given market, the lifecycle or time between purchase decisions, the presence of non-energy benefits, and the incremental cost associated with the efficient product without the MT intervention. It is also important to consider the strength of identified barriers to adoption for a given product. These barriers often emerge from market research or market characterization studies and can point to installation or supply barriers that might otherwise be missed. In some cases, the Natural Market Baseline can be zero for a number of years. This might be the case when an MT initiative catalyzes the entrance into the market of a technology that otherwise would not have emerged for many more years.
4. **Incorporate anticipated changes to codes and standards** to the extent they are known in the baseline. The special case of savings from energy codes and standards is discussed further in the Energy Codes and Standards section of this protocol.
5. **Identify any known data gaps** that emerged in the planning process needed to improve the forecast over time and monitor these gaps as the initiative progresses.

Relevant information and their sources should be included in the Energy Savings Framework (ESF) document.

2.3 Reviewing Natural Market Baseline Over Time

It is important to track the baseline forecast periodically as part of MPERs or other recurring efforts to assess the progress of the program and the target market. Changes should be made to the Natural Market Baseline if a determination is made that new evidence suggests that the original forecast needs to be adjusted in order to accurately portray market behavior going forward, as discussed below.

Criteria for Updating the Natural Baseline Market Forecast

The fundamental reason for periodically reviewing the initial baseline forecast is because better information is likely to become available over time that may allow improvements in the accuracy of the initial forecast. The Natural Market Baseline forecast is a major determinant of the estimated savings attributable to the program. Given the challenges inherent in forecasting a counterfactual scenario, Natural Market Baseline often constitutes the biggest

¹³⁹ In statistics, a probit model is a type of regression where the dependent variable can take only two values, for example married or not married.

¹⁴⁰ EMI Consulting. Con Edison 2017 Retail Products Platform (RPP) Evaluation. June 15, 2018.

individual source of uncertainty surrounding estimated savings. As such, incorporating enhanced information regarding the Natural Market Baseline forecast helps both in building an improved qualitative case for attribution for observed market changes, and in supporting adaptive management of the program.

At the same time, it can be counterproductive and costly to update the baseline forecast too easily or too often. What is typically most readily available to the evaluator is the actual trajectory of total number of efficient units appearing in the market, which may well reflect effects from the MT program itself. This raises the risk that evaluators may decide that an observed acceleration in efficient market share is due to an acceleration in the Natural Market Baseline when it is actually due to the effects of the MT program, thereby leading to underestimation of the program's accomplishments – or the reverse can happen. Deciding how often to update the baseline forecast requires stakeholders to balance the desirability of incorporating valuable new information with the importance of ensuring reasonable treatment.¹⁴¹

Criteria for triggering an adjustment of the NMB should be agreed upon by program administrators and evaluators at the same time as development of the original baseline. At a minimum, each MT initiative's ESF should be re-assessed once per plan cycle regardless of the MTI's reopening criteria. Evaluators should examine all critical aspects of the ESF during this time including, but not limited to, the natural market baseline, unit energy savings, forecasted sales, market shares, and known codes and standards. Should the Evaluator determine a revision to an ESF is required, the existing ESF will apply to the funding utility for a maximum of two years, or until a new ESF is complete and adopted, whichever is shorter. As an example, if the 2023 program year evaluation triggers the need to revise the ESF, the utility will apply the existing ESF through 2025 at the longest, as the new ESF is drafted. Revisions to the ESF for a MT initiative apply prospectively to future program years.

The following are examples of some key circumstances where it may be appropriate to update the initial Natural Market Baseline forecast:

1. **Key assumptions underlying the initial forecast have proven to be incorrect.** For example, the initial forecast may have reflected an assumption that in the absence of intervention, manufacturers would have little naturally-occurring incentive to incorporate a key energy-saving feature into their products, and it might become clear with the passage of time that this assumption was incorrect.
2. **The timing of key anticipated events has changed.** Examples might include a product launch being substantially delayed, a key partner ceasing operations, or an energy code or standard opportunity being delayed. All of these factors could affect the baseline forecast if it was built assuming certain events would impact the naturally occurring adoption.
3. **Changes in exogenous conditions affecting the target market have altered the initial trajectory of the Natural Market Baseline.** Examples might include a substantial change in public policy brought about by an electoral outcome, or economic conditions that create unexpected shifts in the level of economic activity (e.g. recession, housing booms, tariffs, unforeseen jump in the price of raw materials, etc.).
4. **Significant improvements in the availability of sales data demonstrate that the initial forecast can be improved without introducing a significant risk of over- or under-estimating program impacts.** For example, the initial forecast may have been based on limited information from key market informants, but over time full category sales data may become available and show that the initial estimate of efficient market share was off base.

¹⁴¹ It is important to note that trying to strike this balance can and does lead to differences in baseline assumptions between MT initiatives and related RA programs. The mission of RA programs is generally to achieve measurable, reliable, near-term savings. From that perspective, it is important that the baseline assumptions reflect the realities at work in the marketplace at any one time. However, the mission of an MT initiative is to gradually achieve large-scale improvements in the way markets work, so it is important that the baseline forecast reflect the conditions facing the initiative at its onset. Resolving these potential differences in the handling of baseline assumptions between MT initiatives and related RA programs is an example of the broader issue of accounting, which is discussed elsewhere in this paper.

5. **The criteria for what constitute an “efficient” product have changed in a manner that tends to superannuate the initial baseline forecast.** Examples might include changes in test procedures or qualifying standards.
6. **Substitute products or innovations have been introduced that change the energy consumption profile of an entire product category.** Examples might include LEDs displacing CFLs, laptop computers overtaking desktops, and the addition of 4k or 8k features to televisions.

Stakeholders should recognize that Evaluators will likely need to conduct additional research to understand and incorporate the new market fundamentals. This will require budget resources and take time. The MT Program Evaluation should include a review of the on-going applicability of the ESF and recommend any additional research required to update the ESF. The specific recommendations and the basis for those changes should be presented to the SAG.

2.4 Accounting for RA Savings

Ideally, customer-facing RA programs would be an integrated part of MT activities. This would allow for counting all savings in the target market regardless of assignment to either MT or RA. However, in the near-term, RA programs are likely to continue to be implemented and evaluated separately from MT programs. As a result, if RA and MT programs are operating simultaneously in the same market, there is a need to parse the savings between the MT and RA efforts. This accounting is done within the Energy Savings Framework.

While the goal of not double counting is clear, the actual practice is complicated by the fact that RA and MT use different methodologies to get to a “net” savings. For example, both methodologies adjust for a counterfactual baseline; designated as free-ridership for RA programs and Natural Market Baseline for MT initiatives. Both methodologies also attempt to estimate market effects that occur beyond the direct program intervention; in an RA program, these effects are designated as spillover, while in an MT context they are accounted for in the NMB. To successfully avoid double counting of savings, the MT Energy Savings Framework must include consideration for all components of the RA framework.

Figure 3 is a depiction of the typical components of RA savings overlaid on the MT savings framework. Area A represents participants who wouldn’t have taken the action without the program, area B is free riders and area C is spillover. As described above, MT savings are Total Market minus Natural Market Baseline.

To avoid double counting with RA programs, the default approach is to subtract all non-Market Transformation verified savings within the same market being targeted by the MT initiative from the MT savings calculated in previous sections¹⁴². If accuracy could be improved or greater cost-efficiency created in the evaluation process from using another method, that can be proposed by the evaluator. An example might be separating the units between the MT and RA activities but using the MT savings per unit (if it differs from the RA savings per unit) as the factor to multiply by the MT units.

¹⁴² Note that the traditional use of the terms “net” and “gross” savings can be confusing in the MT framework. The MT savings calculation described in the first equation in Section II results in savings that are attributed to utility programs (both MT and RA) – typically called “net” in RA evaluation. This section then further nets out RA savings so MT savings can be separately analyzed.

Figure 3. Accounting for RA and MT Program Savings

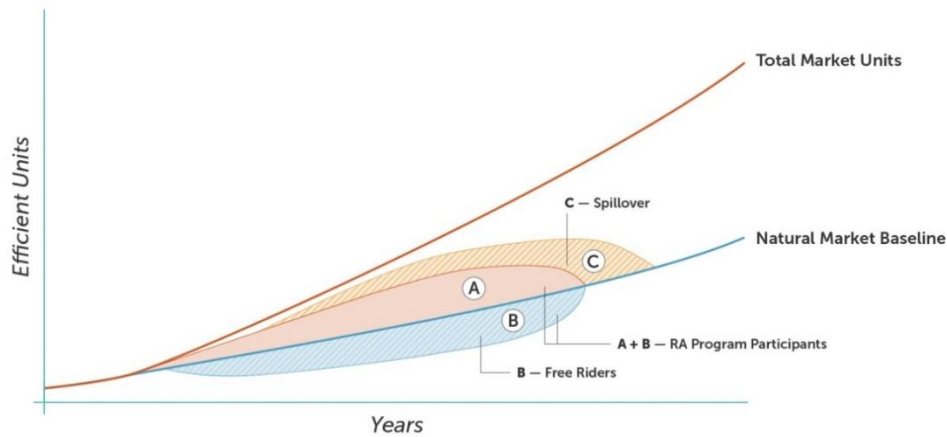

A key benefit of netting out all RA claimed savings is that it allows for a straightforward assertion that “all savings counted through the RA program have been removed from the MT initiative savings”. This simple statement may satisfy the needs of regulators and stakeholders without requiring further detail on the differences between the RA and MT frameworks.

On the other hand, this technique creates a bias against MT initiatives in favor of counting the savings in RA. This is because it has the unfortunate consequence of removing legitimate market effects (like spillover) from the MT initiative. This could discourage coordination and collaboration between MT initiatives and RA programs.

2.5 Allocating Energy Savings to Individual Utility Sponsors

Market boundaries rarely, if ever, align completely with the geographic boundaries of utility service territories. While it is possible for an individual utility to operate a market transformation program that is limited in scope to the boundaries of their own service territory, it is more likely that utilities will be implementing MT initiatives in collaboration with other entities at a state, regional, or even nationwide level. In multi-sponsored MT initiatives, an allocation scheme should be used to distribute savings to each sponsoring utility/efficiency organization. Historically, there have been several different approaches to utility allocation, although most of them attempt to base the proportion to each utility on estimated savings that land in that utility’s service territory. The method used should be selected in advance.

1. **Allocation by Sponsor Funding Shares** In this approach, energy savings are allocated to each funder according to their share of the total MT initiative funding across all participating sponsors. In the Northwest, this approach is applied at a portfolio level to the total savings, partially because funding shares are based on the relative energy loads of the utilities.
2. **Allocation by Service Territory Delivery** This approach allocates energy savings based on an attempt to track market adoption of the energy efficient units (and therefore savings) to the geographic boundaries of the sponsoring utility. Unfortunately, most MT initiatives track efficient units at a scale different than utility service territory (such as to the point of distribution or retail sale), and methods must be used to scale these units to the service territory of the utilities operating the initiative. In these cases, a factor is developed in advance to share retail sales from the point of sale or distribution into an allocation to each of the utility service territories served by that channel. It is best to develop this factor ahead of time and use it consistently throughout the program, unless compelling data becomes available that would justify a change in the methodology. The adjustment can sometimes be made by working with the channel to get estimates of the zip codes of their clientele and then correlate that to the service territory zip codes. In the Northwest,

for example, Bonneville Power Administration developed a retail sales allocation tool where retail locations are divided up by how they serve customers from different utilities.

3. **Allocation by Tracking Participants** There may be initiatives where it is possible to track all participants – for example, Building Operator Certification where every tracked operator comes through the initiative itself. This can then be a direct measurement.
4. **Allocation by Survey of Market** This approach samples the entire market and asks survey questions about in which service territory the efficiency is occurring.
5. **Allocation by Customer Proportions or Energy Consumption** This approach allocates energy savings based on the share of total customers or energy consumption within the sponsoring utilities service territories, or if known, shares within a particular market. Customers or consumption in this approach are a proxy for relative market share for the MT initiative. Examples include total residential single-family homes with a certain type of appliance, number of industrial customers of a certain size, or total energy consumption of commercial end use loads for the market end use in question.

2.6 Estimating Savings Post Active-Market Engagement in Markets without Codes or Standards as an Endpoint

Not all MT initiatives have the possibility of a code or standard to lock-in sustained market change or will be successful in the achieving the desired code or standard. For example, programs seeking to change standard practice in operations and maintenance, influence recommendations for building upgrades in existing buildings (not typically affected by new construction codes) or create change via training often cannot rely on a code or standard to ensure sustained adoption. Even without a code or standard, it is still possible for estimated MT savings to become significant as the market adoption rate can grow exponentially. Therefore, it is important to design market evaluation components that support ongoing measurement and estimation of total market adoption and efficient units, even after MT investments have subsided. There may also be exogenous market factors that could trigger a reforecast of the Natural Market Baseline during this post period (see Section 2.3). A periodic independent evaluation of these elements is recommended to support continued and accurate calculation of successful, long-term MT savings.

Key considerations for post-active market engagement energy savings estimation include:

- **Total Market Units** Data collection for total market units may be more challenging if the market actors who previously provided full market data are not willing to continue doing so without an active value transaction. In some situations, access to sales data could continue via contractual agreements with key market actors. In many scenarios, however, analysts will need to infer market changes through surveys, adjustments to purchased third-party data, or on-going market studies.
- **Unit energy savings** Given the wider market adoption at this point; it may be necessary to adjust the unit energy savings estimate. For example, with wider adoption there may be better data about the actual energy savings performance of the efficient measure. Key assumptions that affect UES during this period may also change as a wider group of users engage with the product or service.
- **Natural Market Baseline** As adoption grows, often other market forces become more apparent and may warrant review and possible adjustment of the Natural Market Baseline. Also, exogenous variables can come into play in the market that simply could not have been foreseen during the initial forecast of the Natural Market Baseline.

2.6.1 Duration of Savings Post Active Market Engagement in Markets without Codes or Standards as an Endpoint

It is important to establish the length of time that savings will be credited to the utility post-active-market engagement. This time period is separate from the lifetime of the measures embodied in savings measures. Instead it reflects the amount of time that a utility will receive credit for having changed the market even when it has no or minimal engagement. In some circumstances, the Natural Market Baseline will be expected to increase over time

until some point where it essentially overtakes the Total Market. This provides a natural ending point for claiming savings from the MT initiative.

In some markets, the Natural Market Baseline will never approach the Total Market, or it will do so in an unreasonably long time frame. In these cases, there is no quantitative analysis to determine duration directly; instead, it requires a policy call that balances an appropriate level of credit to make it worth the effort to support MT initiatives without counting savings into perpetuity. Factors to consider in crafting this determination include the likelihood of the baseline changing over time and the lifecycle of the product (which influences when things would have changed anyway). The duration of energy savings should be addressed and captured in the Energy Savings Framework. Given that this is a policy call, it is usually best to make this decision early in the MT initiative design process to provide certainty to program designers and implementers.

2.7 Energy Codes and Appliance Standards

Best practice in MT initiative design will identify applicable codes or standards early on and design interventions over the life of the initiative to accelerate early adoption of more efficient energy codes and standards when possible. If an MT initiative can successfully influence the code or standard to incorporate higher levels of efficiency, the initiative can effectively “lock-in” sustained efficiency changes for virtually the entire market. Logic models for MT initiatives will often include activities that are deliberately targeting and driving towards adoption of enhanced energy codes or standards (C&S). Energy savings that occur following successful adoption of efficient C&S¹⁴³ are often a significant portion of the energy savings claimed. In California¹⁴⁴ and the Northwest, savings from C&S currently represent significant portions of the energy savings in their energy efficiency program portfolios.

Illinois does not yet count savings from energy codes or increased compliance, but as of this writing is discussing possible activities to influence energy code compliance and potential adoption of higher efficiency levels in energy codes and standards. This Attachment describes savings estimates from energy codes adoption¹⁴⁵ because these are often part of MT efforts¹⁴⁶ and energy code compliance enhancement activities because they increase the effectiveness of the codes.

Figure 4¹⁴⁷ depicts the course of an MT initiative with an emphasis on the portion that affects energy codes¹⁴⁸. This figure shows a market where the natural market baseline does not have a regular code adoption cycle, but if that is the practice for the market being analyzed, anticipated energy code adoptions and their efficiency level would be included in the baseline. Area A represents the savings that accrue to activities in an MT initiative that prepare the market before C&S adoption and can include the wide variety of activities that are shown in Figure 1. Area B represents the savings following adoption of a new C&S. There are many activities that could be sponsored by utilities at the point of adopting a code or standard (just before the “code effective” vertical line). Some examples include developing model C&S language, providing technical and economic analysis and support, or submittal of C&S proposals.

¹⁴³ Energy code compliance is a key factor in the actual savings resulting from a code, and this is discussed in a later section.

¹⁴⁴ See TRC (2019) Codes & Standards Program Advocacy & Attribution study for a review of California’s methods for codes and standards savings.

¹⁴⁵ Savings for “stretch” codes are covered by this discussion of codes and standards. If allowed by the state, a stretch code means local jurisdictions can adopt a code that is beyond the state code and is mandatory only for builders within that local jurisdiction. Savings would be calculated per this section, but only applied to buildings in the adopting jurisdiction.

¹⁴⁶ It should be noted that California has similar calculation methods for savings from codes and standards, although they weren’t developed specifically under an MT framework. Massachusetts has developed a method for savings for code compliance that is similar to RA program analysis other than how attribution is estimated.

¹⁴⁷ Note that compliance with the energy code is usually less than -- and can sometimes be greater than 100%. Compliance greater than 100% can occur, for example, if the typical measure most readily available is more efficient than the code requirement; builders will simply use the available measure.

¹⁴⁸ In calculating savings, the effective date of the energy code or standard adoption drives the uptick in the number of efficient units meeting the efficiency level. In this paper, the term “adoption” is short-hand for the energy code or standard adoption, which would have an effective date by which most units will comply.

Figure 4. The Effect of Energy Code Adoption

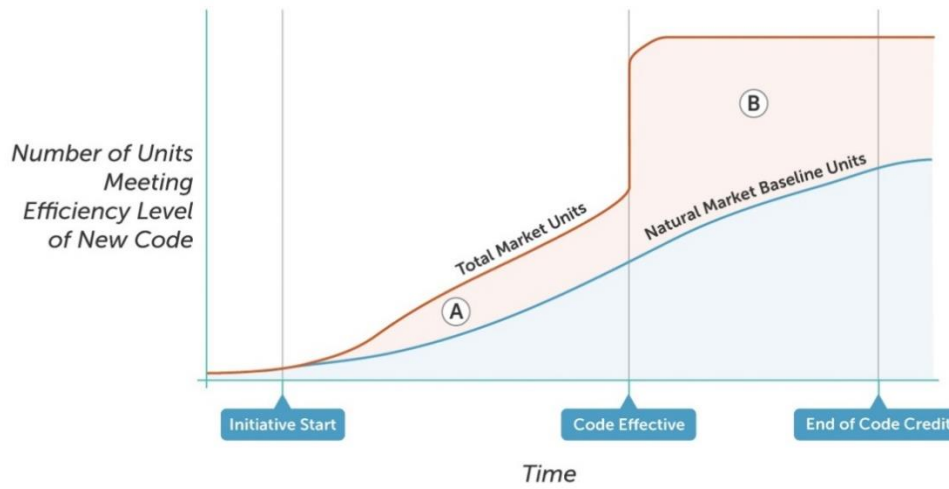

If an MT initiative includes C&S activities as part of its logic model, energy savings from the pre-adoption period A in Figure 4 are counted using the methods described earlier. In addition, it can be credited with energy savings post-adoption B, which are also derived using the methods described earlier, but with some additional considerations, described below.

2.7.1 Additional Considerations for Savings from Codes and Standards

149

This section describes the additional items needed to calculate savings from Codes and Standards (C&S). Per unit savings and total market units are calculated as described above. Additional factors that need consideration for C&S include:

- **Compliance rates when a new energy code is adopted:** Total Market Savings should be adjusted for measured or estimated compliance rates. Measured compliance pre- and post-adoption of the new energy code is strongly preferred, but not always available. In this case, a baseline compliance rate pre-adoption either measured or estimated is usually assumed to be the same post-adoption for purposes of energy savings estimation.
- **Post-adoption Natural Market Baseline:** Special attention should be given to the segment of the Natural Market Baseline (from energy code adoption to the end of energy code credit). The best representation of the counterfactual might be a fixed post-adoption baseline that changes to full adoption rates during the next scheduled change in the C&S processes (e.g. 3 years for the International Energy Conservation Code). Another option is some form of declining savings credit, such as a baseline that increases over time.
 - Determining the timing of this counter-factual movement in some alternate future has been difficult in those regions already counting savings from energy code adoption. One approach involves expert subject matter panels (Delphi panels) to establish this alternative future. However, finding enough independent experts and achieving convergence of opinion can be challenging. Trending market data or comparison with other similar code provision adoptions may also be used as alternatives. Ultimately, as with all counterfactual baseline estimation, there will need to be an aspect of professional judgement to determine the appropriate treatment of post-adoption baseline.

¹⁴⁹ A paper by Cadmus *et. al.* in 2013 describes the estimation of energy code adoption and energy code compliance savings in depth starting on page 52.

- **Accounting:** Accounting of savings between RA and MT programs is not generally used for C&S. This is because utility RA programs typically have ended operations before or at the point that the energy code adoption process takes place.
- **Allocation:** In principle, allocation of energy savings that occur from an MT initiative supported by multiple sponsoring utilities and targeting statewide code changes should be no different than during the voluntary portion of the MT initiative (see above section on allocation). In addition, there may need to be a split between utilities and other parties working on code adoption. This is often a negotiated number, sometimes informed by a Delphi panel, evaluators, stakeholders, or other entities.
- **Duration of Energy Savings Claims¹⁵⁰:** It is important to establish the length of time that savings will be credited to the utility for the new code or standard. This is shown in Figure 4 as the time between “Code Effective” and “End of Code Credit”. This time period is separate from the lifetime of the measures embodied in the energy code. Instead, it reflects the amount of time that a utility will receive credit for having changed the energy code.
 - There is no quantitative analysis that can determine the duration of an energy code credit to the utilities; instead, it requires a policy that provides an appropriate level of credit to implementers that makes it worth the effort to support MT initiatives that target code changes, while not being so large as to be unfair to ratepayers. The policy call can be informed by when the code or standard would have been updated anyway to the level targeted in the MT initiative. Given that this is a policy call, it is usually best to make this decision early in the MT initiative design process to provide certainty to the program designers and implementers. For example, the Northwest negotiated a standard policy that allows for claiming code savings for ten years post the code effective date. For the residential code, NEEA does not report savings units six months after the code becomes effective, and then counts savings for a full ten years. This was a negotiated number among the parties involved at the time. If a new, more efficient code comes into play during that period, the incremental savings for that change are also counted for ten years.

2.8 Energy Savings from Enhanced Energy Code Compliance Activities

From work in other regions, a number of activities, such as training and education, increased support for enforcement, and third-party plan-review have been shown to result in increased compliance of energy codes, which in turn results in energy savings¹⁵¹. Efforts are underway in Illinois to analyze and discuss activities for improving compliance with existing energy codes.

Savings from enhancing code compliance activities are derived by documenting compliance rates before the initiative starts¹⁵², and compliance after the initiative has operated for a period of time. See Figure 5.

¹⁵⁰ Duration of savings claims can interact with the considerations in the Natural Market Baseline since this baseline can sometimes equate to Total Market Units over time, and therefore savings effectively become zero.

¹⁵¹ For examples of recent evaluation reports analyzing the effects of compliance support programs on compliance rates in the residential and non-residential sectors, respectively, see NMR Group, Inc. (2018) and NMR Group, Inc. and Cadmus (2018): NMR Group, Inc. 2018. Residential New Construction and CCSI Attribution Assessment (TXC48). http://ma-eeac.org/wordpress/wp-content/uploads/TXC_48_RNCAttribution_24AUG2018_Final.pdf
NMR Group, Inc. and Cadmus. 2018. Massachusetts TXC47 Non-Residential Code Compliance Support Initiative Attribution and Net Savings Assessment. http://ma-eeac.org/wordpress/wp-content/uploads/TXC_47_Nonres_CCSI_Attribution_Assessment_26July2018_Final-1.pdf.

¹⁵² The Midwest Energy Efficiency Alliance is currently developing field data to determine compliance with current energy codes, and analyze which measures create the largest gap in savings.

Figure 5. Savings from Enhancing Energy Code Compliance

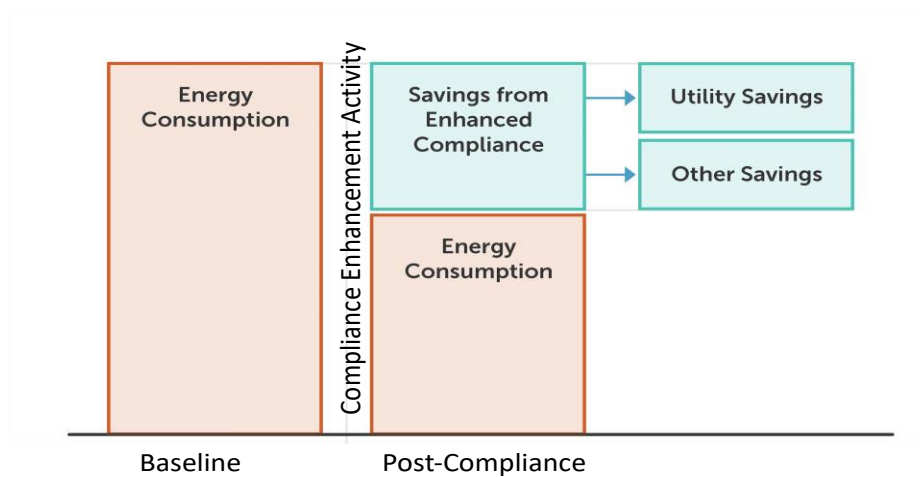

Unit energy savings¹⁵³ is the difference between the average unit energy consumption in the pre-enhanced-compliance case compared to the post-case¹⁵⁴ multiplied by the number of new units each year in the market that are affected. This is typically developed using building energy-use modeling of the baseline and post-compliance cases, and then subtracting the two. The building energy modeling should follow the practices for new construction modeling in the TRM for residential or commercial buildings as appropriate.

The per unit energy consumption for the baseline case is computed based on total building energy consumption with either measured or assumed compliance for all energy-impacting measures in the building. The per unit energy consumption for the post-compliance-enhancement activities is similarly calculated but using the energy-impacting measures of the post-compliance-enhancement building. For example, per building energy savings for wall insulation would be calculated by subtracting the building energy use assuming post-compliance-activity insulation amounts in the walls from an equivalent building energy use with the baseline wall insulation amounts. These building level savings are then divided by the square feet of the building to derive an average UES/square foot. This in turn is multiplied by the number of square feet in the market that are affected to derive the total compliance-enhancement related savings.

Total savings are then reviewed for the savings directly resulting from the efforts of the utility, versus other causes. Examples of other causes that can create enhanced code compliance include suppliers who might stock only “above code” materials or “spillover” from other larger jurisdictions that make it uneconomical for builders to change practices across jurisdictions. Most often, the split between utilities and other causes is a negotiated number among utilities and stakeholders which is sometimes informed by a Delphi panel that gives input to a third-party evaluator on their opinion of the utility’s contribution if there are enough independent experts to form a Delphi panel.

2.8.1 Duration of Enhanced Energy Code Compliance Savings

Similar to the duration of savings credit for other MT initiatives, the actual value is a policy call. However, in the case of enhanced code compliance activities, duration of the activities is usually deemed to be the period of time that the particular code is in place. Once the code changes, (for example, every three years for the International Energy Conservation Code (IECC)), then credit for compliance-enhancement savings from the prior code would be stopped. This is because compliance savings are tied to a specific set of measures, and those measures may change when the

¹⁵³ In some cases, enhancing the compliance or effectiveness of measures in the code can have an impact on savings already incorporated in a TRM. If Illinois moves forward with enhanced code compliance, this could be an adjustment in the future to other sections of the TRM.

¹⁵⁴ If both compliance and increased efficiency happen at the same time, the savings can be calculated separately for each and summed.

code changes.

2.9 Uncertainty and Risk in MT Savings Estimates

MT interventions operate with a different level of certainty than many resource acquisition (RA) programs. Experimental design and tight error bounds on realized energy savings are not realistic expectations for initiatives that seek to animate, but not control, market shifts. One key reason for this greater uncertainty, as discussed above, is the greater difficulty of establishing attribution. In addition, needed market data (particularly sales data) can be hard to obtain. Finally, uncertainty also stems from items such as a rapidly changing product category or a reliance on the level of influence of retail salespeople.

To help utilities and other stakeholders assess the risks associated with this uncertainty, program designers should engage early with planning and evaluation professionals with experience in market transformation. Establishing energy savings methods associated with the proposed intervention and gaining acceptance for the proposed baseline often requires multiple rounds of review and refinement as data and assumptions are vetted. At the time of this writing, it is anticipated that the Illinois Stakeholder Advisory Group Working Group on Market Transformation Savings will serve as a forum to effectively plan MT initiatives and navigate unexpected market events.

2.10 Market Transformation Savings Protocol Process Recommendation

In 2022, the SAG Market Transformation Savings Working Group (SAG MT Savings Working Group) developed the Market Transformation Savings Protocol Process Recommendation which aims to:

- Formalize the MT process to streamline activities to reach consensus on MT Savings Protocols
- Define a set of recommended deliverables and work products that build to final MT Savings Protocols
- Provide recommendations on the order of operations for deliverables and work products
- Define a recommended set of activities and components
- Define a dashboard through which utilities can provide regular updates to SAG MT Savings Working Group participants

The Process Recommendation document is posted on the SAG MT Savings Working Group webpage: https://www.ilsag.info/mt_savings_working_group/

The processes outlined in this document are recommendations that provide guidance for actors working on MT initiatives in Illinois to help minimize the time necessary to reach consensus on MT Savings Protocols; the Process Recommendations document is not meant to be a formal checklist with requirements for each step. The Process Recommendations describes the foundational information and components of MT Savings Protocols that can be agreed on prior to utility implementation of a MT initiative. The specific process steps are likely to differ by MT initiative.

2.11 Market Transformation Program Design, Savings Protocol and Evaluation Plan Documentation

For Program Administrators, Stakeholders and Evaluators to be able to have an informed discussion and reach consensus on the anticipated savings for an MT Program, the Program Design (Logic Model) and ESF (the Market Characterization and Projection), along with supporting analyses, need to be documented. In addition, the MT Program Evaluation Plan should be developed and shared before a program is initiated. The Evaluation Plan will provide and explain the set of EM&V research tasks and how they will collectively meet the Preponderance of Evidence criteria explained in Section 2.1. These documents and the process for their development and review are summarized in Table 2.

Table 2. Summary of Market Transformation Program Supporting Documents

Document	Energy Savings Framework	Program Plan/Logic Model	Evaluation Plan
Summary of Document	<i>Market Characterization (Historical trends; market projection with NMB; unit sales & energy savings)</i>	<i>Program actions & intent; expected short-term and long-term outcomes; MPI's & measurement</i>	<i>Proposed evaluation research methods and plan – MPI's & ESF</i>
Document Developer	<i>Program Administrator (utility) with Implementation Contractor</i>	<i>Program Administrator (utility) with Implementation Contractor</i>	<i>Program Evaluator</i>
Review	<i>Program Evaluator (especially NMB); SAG</i>	<i>Program Evaluator; SAG</i>	<i>Program Administrator (utility) with Implementation Contractor; SAG</i>
Updating Process	<i>Evaluator assesses on-going adequacy of ESF; Change Recommendation reviewed by Program Administrator (utility) with Implementation Contractor and SAG</i>	<i>As needed by Program Administrator (utility) with Implementation Contractor with Recommendations by Evaluator</i>	<i>Updated annually by Evaluator; reviewed by Program Administrator (utility) and SAG</i>

3 Appendices

3.1 Appendix A: MT Initiative Business Plan Outline

The MT Initiative Business Plan is intended to document the strategy, data, and assumptions about the initiative at the time of launch. It is a document that can evolve as knowledge of the market and the initiative evolves but is essential to prepare and guide launch of the initiative into the market.

Key components of the Business Plan include:

1. Identification/description of the specific market to be targeted
2. Description of the “leverage” point(s) that catalyze transformation
3. Logic Model or hypothesis of how the planned intervention will result in the desired market change
 - a. Barriers that prevent market adoption
 - b. Activities/interventions that will catalyze the change
 - c. Outputs that result from the activities
 - d. Market Outcomes (short-, medium- and/or long-term) that are measurable responses to the activities
 - e. Ultimate desired impact – which is the final state of the market after it is transformed.
4. Market Progress Indicators
 - a. Data collection/management plan
 - b. Document any input from evaluators
5. Multi-year budget
6. Multi-year savings, including description of baseline over time
7. Estimate of cost-effectiveness
8. Names of utilities most likely to be involved with operating this initiative
9. Description of interaction with other programs (if any) by utility

10. Description of Jobs or Disadvantaged Community Impacts
11. Discussion of risks specific to this initiative
12. Date of adoption and Date of amendment(s), if any

3.2 Appendix B: Glossary of Terms

Above Natural Market Baseline Savings Net of RA Savings – The residual estimated energy savings computed by subtraction of energy savings claimed by an RA program.

Accounting – For purposes of this document, accounting refers to the practice of adjusting MT above market baseline savings to net out energy savings being claimed through any RA programs operation in the same market.

Adoption Date (of Code or Standard) – The date when the change in a building code or appliance/equipment standard was adopted by the rule-making authority.

Allocation – The process of allocating energy savings from MT programs to multiple sponsors of an MT initiative that operates across multiple sponsoring utilities; e.g. at a state or multiple state regional level.

Attribution, general – The concept of attributing causality for claimed energy savings to specific or general actions by the utility(s) as opposed to other agents acting in the same market. Attribution provides credible evidence that there is a causal link between the program activities and the outcomes achieved by the program.

Attribution, MT Programs – Attribution of all energy savings not counted in the Natural Market Baseline to utility funded interventions, including RA, MT, and supporting infrastructure. Note that this is not actually a statement of causality but rather a measurement by subtraction of Natural Market Baseline.

Attribution, RA Programs – In traditional RA program attribution is generally approached through application of an adjustment factor that adjusts “gross energy savings” measured through the program participants to account for “free-ridership”; i.e., those participants that would have acted without the RA program. For RA programs, this adjustment is usually represented in a “net-to-gross” (NTG) factor that is multiplied by gross energy savings to get “net” energy savings that can be “attributable” to the RA program.

Counterfactual – A constructed alternative future that might have happened without the intervention of either the MT or RA programs.

Estimated Market Transformation Savings – The residual estimated energy savings computed by subtraction of the natural market baseline savings from total market savings. These estimated savings are assumed to be associated with all utility funded market interventions including MT and RA programs, supporting infrastructure, and codes and standards activities. Analogous to the space above the Natural Market Baseline in Figure 2.

Estimated Market Transformation Savings Net of RA – The residual estimated energy savings after subtracting energy savings claimed by a resource-acquisition (RA) program from Estimated Market Transformation energy savings operating in the same geographic service territory.

Free Riders – A program participant who would have implemented the program’s measures or practices in the absence of the program. Free riders can be: (1) total, in which the participant’s activity would have completely replicated the program measure; (2) partial, in which the participant’s activity would have partially replicated the program measure; or (3) deferred, in which the participant’s activity would have partially or completely replicated the program measure, but at a future time beyond the program’s time frame.

Full Category Data – Sales data (individual SKU, price and numbers sold) for all units of a specific product including both efficient and inefficient versions typically sold through a retail or distributor channel. May also refer to data available from manufacturers or trade associations that includes all units manufactured or sold.

Hedonic Price Modelling – a statistical approach that controls for a variety of variables and attempts to isolate the incremental cost associated with the feature of interest.

Logic Model – a graphic depiction of the shared relationships among the activities, outputs, and outcomes of a program. The theory of change should be visible in the logic model.

Market – an actual or nominal place where forces of demand and supply operate, and where buyers and sellers interact (directly or through intermediaries) to trade goods, services or contracts or instruments, for money or barter.

Market Progress Evaluation Report (MPER) – A report on MT program progress, usually conducted in parallel with program implementation over a relatively short (e.g. 12 months) timeline. Best practices would have these evaluation activities conducted by a third party. [Note that there are regionally distinct terms for similar evaluation products, including Market Evaluation. The specific term is less important for the purpose of this framework than the need to acknowledge that market transformation requires a somewhat different evaluation scope and product than might be required of other programs.]

Market Progress Indicator (MPI) – A measurement of market progress for a specific indicator of an element of MT theory described in the program logic that defines the associate barrier/opportunity/intervention strategy and anticipated outcomes from successful implementation. [Note that regional differences exist in how these indicators are labeled, including the term Market Indicator. The specific term is less important than the fact that the indicator refers to activities occurring within the market, rather than within the program, and that they will likely include long-term indicators that can take years to emerge.]

Market Transformation (MT) – The strategic process of intervening in a market to create lasting change that results in the accelerated adoption of energy efficient products, services, and practices.

MT Business Plan - A document embodying the strategy, data, and assumptions about the MT initiative at the time of launch. It includes a description of the efficiency opportunity, targeted markets, assessment of barriers and opportunities, intervention strategies, near-, mid- and long-term market outcomes, market progress indicators and key energy savings estimation assumptions.

Natural Market Baseline Savings – The estimated energy savings computed based on a market adoption rate forecast of what would have happened without any utility funded interventions that may include both MT and RA programs as well as enabling infrastructure support. The forecast of Natural Market Baseline is generally established before the start of the MT initiative but may be revised periodically.

Resource Acquisition (RA) – An approach to capture energy efficiency grounded in a regulatory framework which views EE as a resource that can be “acquired” through direct utility action analogous to any other “resource” considered by a utility to meet its existing and future energy requirements. These can be thought of as traditional utility-driven energy efficiency programs that typically work at the individual consumer level, rather than the market level.

Spillover – Reductions in energy consumption and/or demand caused by the presence of an energy efficiency program. There can be participant and/or nonparticipant spillover:

- **Participant spillover** is the additional energy savings that occur as a result of the program’s influence when a program participant independently installs incremental energy efficiency measures or applies energy-saving practices after having participated in the energy efficiency program.
- **Nonparticipant spillover** is energy savings that occur when a program nonparticipant installs energy efficiency measures or applies energy savings practices as a result of a program’s influence.

Summative Report – An evaluation report that attempts to quantify and assess the outcome effects for a given program period. Distinguished from “process evaluation” and consistent with “impact evaluation” in energy efficiency.

Total Market Savings – The estimated energy savings computed based on all market adoption above and beyond the adoption rate at the start of the MT initiative.

3.3 Appendix C: References

Chen, Huey-Tsyh. 1990. *Theory-Driven Evaluations*. Sage Publications.

EMI Consulting, 2017. *Con Edison 2017 Retail Products Platform (RPP) Evaluation*. June 15, 2018. Accessed 6/5/2019 at <https://www.dps.ny.gov/>

EMI Consulting and Richard Ridge, 2015. *California 2016-2019 Retail Products Platform Program Pilot: Evaluation Plan*.

Evaluation, Measurement and Verification Working Group, 2018. *ENERGY STAR® Retail Products Platform (RPP): Conditions and Considerations in Evaluating Market Transformation Programs and Evaluation Guidance for RPP*.

Prahl, Ralph, and Ken Keating, 2014. *Building a Policy Framework to Support Energy Efficiency Market Transformation in California*. White paper written for the California Public Utilities Commission, San Francisco.

Navigant Consulting, February 2019. *ComEd Energy Efficiency Program Energy Efficiency Market Transformation Summit Report*. <https://www.navigant.com/experience/energy/2019/energy-efficiency-market-transformation-summit> https://www.navigant.com/-/media/www/site/downloads/energy/2019/market-transformation-summit-report.pdf?la=en&utm_source=Direct&utm_medium=PDF_MTS

NMR Group, Inc., 2013. *A Review of Effective Practices for the Planning, Design, Implementation and Evaluation of Market Transformation Initiatives*. CALMAC study ID PGE330.01.

NMR Group, Inc., 2014. *Methods for Measuring Market Effects of Massachusetts Energy Efficiency Programs*. <http://ma-eeac.org/wordpress/wp-content/uploads/Methods-for-Measuring-Market-Effects-of-Massachusetts-Energy-Efficiency-Programs.pdf>

Keating, Ken, 2014. *Guidance on Designing and Implementing Energy Efficiency Market Transformation Initiatives*. White paper written for the California Public Utilities Commission, San Francisco.

Lee, Allen, Dan Groshans, Peter Schaffer, Alexandra Rekkas, Richard Faesy, Lynn Hoefgen and Phil Mosenthal, 2013. *Attributing Building Energy Code Savings to Energy Efficiency Programs*. Report prepared for Northeast Energy Efficiency Partnerships, Innovation Electricity Efficiency, and the Institute for Market Transformation.

Metrics, Tracking and Performance Assessment Working Group, 2018. *Market Transformation Metrics and EM&V Coordination Report*. White paper submitted to the New York Department of Public Service by the Clean Energy Advisory Council.

Ridge, Richard, Brian Arthur Smith, Julie Colvin, and Luke Nickerman, 2015. *Modifying California's Traditional Resource Acquisition Benefit-Cost Analysis to Accommodate Market Transformation Programs*. In *Proceedings of the 2015 International Energy Program Evaluation Conference*. Long Beach.

TRC, 2019. *Codes & Standards Program Advocacy and Attribution Study*. CALMAC Study ID: SCE0435.01. Report prepared for the California Public Utilities Commission.

Weiss, Carol H. 1998. *Evaluation Methods for Studying Programs and Policies, 2nd Edition*. Upper Saddle River, New Jersey: Prentice Hall.